

cannon

# CA-COM Industrial Connectors



**ITT**

ENGINEERED FOR LIFE



# ITT Inc.

ITT is a diversified leading manufacturer of highly engineered critical components and customized technology solutions for the energy, transportation and industrial markets. Building on its heritage of innovation, ITT partners with its customers to deliver enduring solutions to the key industries that underpin our modern way of life. Founded in 1920, ITT is headquartered in White Plains, N.Y., with employees in more than 35 countries and sales in a total of approximately 125 countries. For more information, visit [www.itt.com](http://www.itt.com).

Our connector portfolio remains the most extensive in the industry, offering a reliable and cost effective range of interconnect solutions with the brands of Cannon, VEAM and BIW Connector Systems. Continuous investment in technology and research & development have enabled ITT to provide new, innovative products and solutions to markets including:



Transportation



Industrial / Instrumentation



Oil & Gas



Defense Vehicles



Commercial & Military Aerospace



Automotive



Computer, Telecom & Consumer Electronics

Our connector portfolio remains the most extensive in the industry, offering a reliable and cost effective range of interconnect solutions

# Introduction to CA-COM

ITT Cannon's circular connector's series CA-COM and CA-COM-B are derivations of the connectors known as SAE-AS50151 (formerly MIL-DTL-5015) and VG95234. Initially designed for military aircraft and combat vehicle application the CA-COM versions have been modified especially for the utilization in various industrial areas. Connectors of both CA-COM series are intermateable and interchangeable with the corresponding types as per SAE-AS50151 and VG95234 as they offer the same mounting dimensions and contact arrangements. The entire CA-COM connector line is ROHS compliant.

## Features and benefits

- The CA-COM standard version is featured by a threaded coupling system while the CA-COM-B types are coined by a "Reverse bayonet" coupling mechanism that offers exceptional vibration protection by a simple 120° turn. The CA-COM-B coupling unit is featured by roller bolts made of stainless steel rolling down the mating ramp, thus reducing coupling torque.
- Various backshell and adapter options, like PG metric gland and heatshrink boot are available amongst others.
- Insulators are made of high quality polychloroprene, which are good for temperatures up to 125°. This material is self-extinguishing, resistant against various fluids like gasoline, lubricants and other fluids of such nature (short time wetting only). In case of lifetime moistening FKM insulator material can be offered as an alternative.
- The contacts are made of copper alloy plated with hard silver finish good for at least 500 mating cycles. There are solder, crimp and PCB contacts in place. The crimp contacts offer a comprehensive range of termination reductions (see pages 41 and 42).
- All solder contacts are ROHS compliant due to a special passivation.

**Contact us for detail or your request for a customized solution.**

### Vital Information:

2D and 3D drawings, connector specifications are available on ITT Cannon's web page: [www.ittcannon.com](http://www.ittcannon.com)  
Please insert the full connector part number into the keyword search field.



---

# Table of contents

---

How to use this catalogue.....	6
Product overview .....	7
Part number creation .....	8–9
Ordering reference .....	10
Contact arrangements.....	11–15
Mounting dimensions .....	16
Seperating and coupling dimensions .....	17
Wall mounting receptacles with endbells.....	18–21
Cable connecting plugs.....	22–25
Wall mounting receptacles .....	26–29
Straight Plugs.....	30–33
Right Angle Plugs .....	34–36
Accessories – Protective caps .....	37–38
Accessories .....	39–40
Contacts .....	41–42
Tooling.....	43–44
Product safety information .....	45

# How to use

This catalog is split in several sections that help you to

- Get an impression what this product is all about (Introduction)
- Get a general overview of all product lines (product overview)
- Get all required detail information (contact arrangements, product details)
- Get all required supporting products (accessories and tooling)

The fastest way to find your product of choice is to follow these steps

---

**1** **Select your product** using either the “part number creation” or the “ordering reference” option

---

---

**3** **Add accessories and tooling options** on the related pages. A connector assembly instruction is available upon request or visit [www.ittcannon.com](http://www.ittcannon.com):  
Enter Keyword "CA Bayonet Assembly Instruction"

---

---

**2** **Use the detail pages** to better understand the available options like connector styles, contact arrangements and contacts options

---

---

**4** **Use the contact information** on the back cover to contact us for further questions or to get advise on where you can purchase our products

---

# Product overview

## ELECTRICAL DATA

**Contact Rating at 20°C (68°F), ambient temperature**

Contact size (AWG/metric)	Rated Current (A <sub>max</sub> ) <sup>1</sup>
16S/15S	22
16/15	22
12	41
8/60/100	74
4/160	135
0/500	245

<sup>1</sup>This applies only to the max. rated current for one contact. If several contacts in one contact arrangement are loaded with higher current the temperature may not exceed 125°C

## Rated Current vs. Ambient Temperature

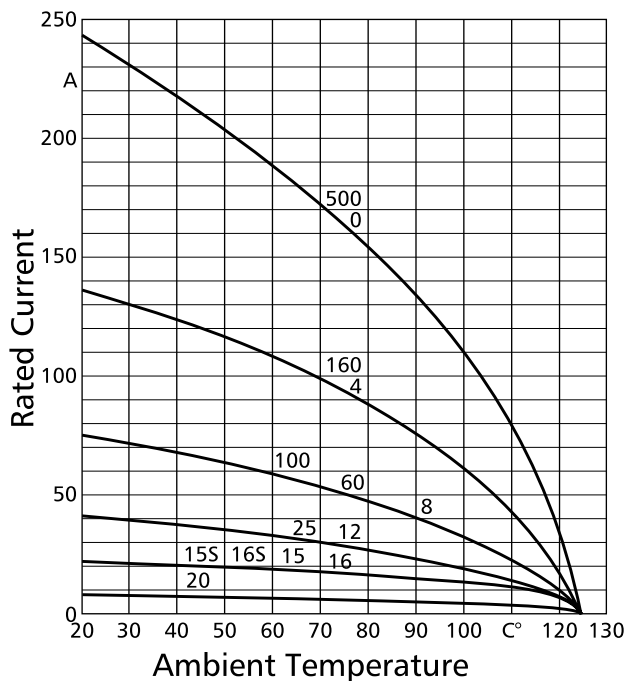

## Contacts Resistance (Millivolt test)

Contact size (AWG/metric)	Contact resistance mΩ max.
16S/15S	6,0
16/15	6,0
12/25	3,0
8/100	1,0
4/160	0,3
0/500	0,2

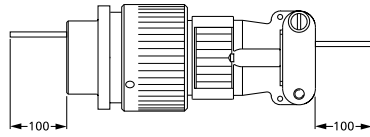

## Insulation Resistance ≥ 1000 MΩ

## Air and Creepage Path (min.)

Voltage class	Instr.	A	D
Air path, mm	0,7	1,1	2,8
Creepage path, mm	0,7	1,1	2,8

## Operation Voltage

As according to specification these connectors are suitable for an operating voltage of 50V<sub>rms</sub> (see Product safety information). However, this is only valid when the connectors are freely accessible during operation and consequently might be touchable.

Dimensions shown in mm | Specifications and dimensions subject to change

## Test voltage

Service rating	Test voltage V <sub>rms</sub>
Instruments	1050
A	1600
B	4500
D	2500
E	3000

## MECHANICAL FEATURES

### Ambient temperature

-55/125°C (-67/257°F)

### ENVIRONMENTAL SEALING Acc. to DIN EN 60068-1

Threaded: Up to IP 65 (in mated condition)

Bayonet: Up to IP 67 (in mated condition)

### Mating Cycles min. 500

### Min. Separating Force per Contact

Contact size		Separating force
metric	AWG	N min
15S/15	16S/16	1,0
25	12	1,5
60/100	8	3,0
160	4	4,0
500	0	8,5

### Contact Retention Apply test force in mating direction

Contact size		Test force
metric	AWG	N
15S/15	16S/16	35
25	12	55
60/100	8	80
160	4	90
500	0	95

## Coupling Torque

The admissible coupling torque has to be tested under harnessed condition

Shell size	Admissible torque		
	Closing and opening (Nm <sub>max</sub> )		Opening (Nm <sub>min</sub> )
	CA-COM	CA-COM-B	
10SL	3,0	1,7	0,15
12S	2,8	2,5	0,23
14S	5,9	3,6	0,35
16S/16	7,0	5,5	0,46
18	8,0	8,0	0,58
20	9,0	9,0	0,70
22	10,6	11,0	0,80
24	12,9	14,0	0,80
28	16,7	17,0	0,92
32	18,1	19,0	1,02
36	23,9	23,0	1,05

## Materials

Shell	Aluminum alloy, Zinc die cast, nickel plated
Contacts	Copper alloy, silver plated
Insulator/Grommet	Polychloroprene

# Part number creation plug

Follow these steps to design your connector part number.

## STEP 1 Select shell style (plug)

Shell Style	Straight Plug		Plug 90°	
	Bayonet	Threaded	Bayonet	Threaded
				
	CA06COM-B	CA06COM	CA08COM-B	CA08COM

## STEP 2 Choose backshell

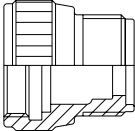
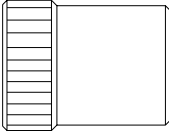
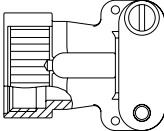
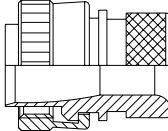
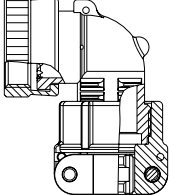
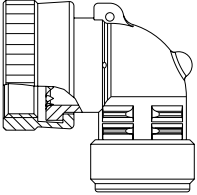
Class F For Flex tube	Class PG; ME For PG or Metric cable glands	Class E General duty, strain relief	Class E Environmental, grommet seal, heat shrink boot adapter Mod. -03; -06 (bayonet), Mod. DN (threaded)	Class E, 90° General duty, strain relief	Class F, 90° For Flex tube
					

**STEP 3** Choose layout see page 11–14 for layouts

**STEP 4** Choose gender P=pin S=socket

**STEP 5** Choose rotation see page 15 for rotation (omit for normal position)

**STEP 6** Choose modification see page 10 for modifications

Design your part number as per above steps

CA-COM-B Example	<b>STEP 1</b> Shell style	<b>STEP 2</b> Class/Backshell	<b>STEP 3</b> Contact arrangement	<b>STEP 4</b> Contact gender	<b>STEP 5</b> Insulation rotation	<b>STEP 6</b> Mod code (max. 4 codes)
	CA06COM	E	20–27	S	W	B – 02







CA-COM Example	<b>STEP 1</b> Shell style	<b>STEP 2</b> Class/Backshell	<b>STEP 3</b> Contact arrangement	<b>STEP 4</b> Contact gender	<b>STEP 5</b> Insulation rotation	<b>STEP 6</b> Mod code (max. 4 codes)
	CA06COM	E	20–27	S	W	– 01 – DN



# Part number creation receptacle

Follow these steps to design your connector part number.

## STEP 1 Select shell style (receptacle)

Wall Mounting		Cable connecting		Box Mounting	
Bayonet	Threaded	Bayonet	Threaded	Bayonet and Threaded (no backshell)	
					
CA00COM-B	CA00COM	CA01COM-B	CA01COM	CA02COM-B	CA20COM

## STEP 2 Choose backshell

**Class F**  
For Flex tube

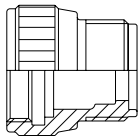

**Class PG; ME**  
Grommet seal with strain relief

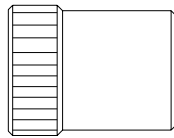

**Class E**  
General duty, strain relief

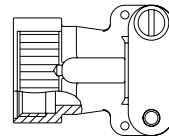

**Class E**  
Environmental, grommet seal, heat shrink boot adapter  
Mod. -03; -06 (bayonet),  
Mod. DN (treaded)

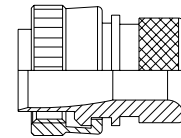

## STEP 3 Choose layout

see page 11–14 for layouts

## STEP 4 Choose gender

P=pin S=socket

## STEP 5 Choose rotation

see page 15 for rotation (omit for normal position)

## STEP 6 Choose modification

see page 10 for modifications

Design your part number as per above steps

CA-COM-B Example	STEP 1 Shell style	STEP 2 Class/Backshell	STEP 3 Contact arrangement	STEP 4 Contact gender	STEP 5 Insulation rotation	STEP 6 Mod code (max. 4 codes)
	CA00COM	PG	18-1	P	X	B - 01

CA-COM Example	STEP 1 Shell style	STEP 2 Class/Backshell	STEP 3 Contact arrangement	STEP 4 Contact gender	STEP 5 Insulation rotation	STEP 6 Mod code (max. 4 codes)
	CA00COM	ME	22-23	S	Y	

# Ordering reference















## Part number explanation

CA 06 COM-E 18-1 P W B- XX  
 CA 06 COM-E 18-1 P W B- XX

<b>Series</b> CA – Cannon Designation	
<b>Shell type</b>	
00 – Wall mounting receptacle	see page 18–21
01 – cable connecting plug	see page 22–25
02 – Box mounting receptacle	see page 26+28
20 – Box mounting receptacle, rear mounting	see page 27+29
06 – Plug, straight	see page 30–33
08 – Plug, 90°	see page 34–36
<b>Class</b>	
COM-E – Endbell with cable clamp <sup>1</sup>	
COM-F – Endbell for flex tube	
COM-PG – Adapter for PG-termination	
COM-ME – Adapter for Metric-termination	
COM-L – PCB solder termination	
<b>Shell size</b>	
10SL, 12S, 14S, 16, 16S, 18, 20, 22, 24, 28, 32, 36	
<b>Contact arrangement</b>	see page 11–15
<b>Contact type</b>	
P – pin	
S – socket	
<b>Alternate insert position</b>	see page 14
Insulator rotation	
<b>Coupling</b>	
B – Bayonet coupling (without designation = threaded coupling)	
<b>Modification</b>	
01 – Metric crimp contacts	
03 – Adapter for heat shrink boots and metric crimp contacts (bayonet coupling only)	
06 – Adapter for heat shrink boots and solder pot contacts (bayonet coupling only)	
44 – With ending and grommet for Classes E, F and PG (available shell sizes only)	
48 – F endbell with O-Ring	
BM29 – Threaded flange holes, shell styles 02, 20 and 00 (threaded coupling only)	
DN – Adapter for heat shrink boots (threaded coupling only)	
F42 – Less backshell / grommet	
F0 – Without contacts (to be ordered separately)	

<sup>1</sup> except shell style 02/20

## CONTACT ARRANGEMENTS

Figure	No. of contacts	Contact arrangements Contact size	Service rating	Insulator position			
				W	X	Y	Z
	3	<b>10SL-3</b> 15S	A	-	-	-	-
	2	<b>10SL-4</b> 15S	A	-	-	-	-
	4	<b>12SA-10</b> 15S	A	-	-	-	-
	3	<b>14S-1</b> 15S	A	-	-	-	-
	4	<b>14S-2</b> 15S	Inst.	-	120	240	-
	5	<b>14S-5</b> 15S	Inst.	-	110	-	-
	6	<b>14S-6</b> 15S	Inst.	-	-	-	-
	3	<b>14S-7</b> 15S	A	90	180	270	-
	7	<b>14SA7</b> 15S	Inst.	-	-	-	-
	7	<b>16S-1</b> 15S	A	80	-	-	280
	5	<b>16S-8</b> 15S	A	-	170	265	-
	3	<b>16-7</b> 15 (A, B) 8 (C)	A	80	110	250	280
	4	<b>16-9</b> 15 (B, D) 25 (A, C)	A	35	110	250	325
	3	<b>16-10</b> 25	A	90	180	270	-
	1	<b>16-12</b> 4	A	0	-	-	-
	10	<b>18-1</b> 15	A (B, C, F, G) Inst. (all other)	70	145	-	290
	4	<b>18-4</b> 15	D	35	110	250	325

## CONTACT ARRANGEMENTS

Figure	No. of contacts	Contact arrangements Contact size	Service rating	Insulator position			
				W	X	Y	Z
	7 5 2	<b>18-9</b> 15 (B, C, E-G) 25 (A, D)	Inst.	80	110	250	280
	4	<b>18-10</b> 25	A	–	120	240	–
	5	<b>18-11</b> 25	A	–	170	265	–
	4 3 1	<b>18-13</b> 25 (B, C) 8 (A)	A	80	110	250	280
	1	<b>20-2</b> 0	D	–	–	–	–
	4	<b>20-4</b> 25	D	45	110	250	–
	8	<b>20-7</b> 15	A (C-F) D (A, B, G, H)	80	110	250	280
	6 4 2	<b>20-8</b> 15 (B, C, E, F) 8 (A, D)	Inst.	80	110	250	280
	9	<b>20A9</b> 25	D (I) A (all other)	–	110	250	–
	19	<b>20A48</b> 15	Inst.	–	80	280	–
	7	<b>20-15</b> 25	A	80	–	–	280
	9 7 2	<b>20-16</b> 15 (A-G) 25 (H, I)	A	80	110	250	280
	3	<b>20-19</b> 8	A	90	180	270	–
	14	<b>20-27</b> 15	A	35	110	250	325
	17	<b>20-29</b> 15	A	80	–	–	280
	11	<b>20-33</b> 15	A	–	–	–	–
	5 3 2	<b>22-12</b> 15 (A, C, D) 8 (B, E)	D	80	110	250	280



## CONTACT ARRANGEMENTS

Figure	No. of contacts	Contact arrangements Contact size	Service rating	Insulator position				Special insulator position	
				W	X	Y	Z		
	19	<b>22-14</b> 15	A	80	–	–	280		
	14	<b>22-19</b> 15	A	80	110	250	280		
	4	<b>22-22</b> 8	A	–	110	250	–		
	8	<b>22-23</b> 25	D (H) A (all other)	35	–	250	–		
	7	<b>24-2</b> 25	D	80	–	–	280		
	16 14 2	<b>24-7</b> 15 (A-M, O) 25 (P, N)	Inst.	80	110	250	280		
	7	<b>24-10</b> 8	A	80	–	–	280		
	9 6 3	<b>24-11</b> 25 (A-C, G-I) 8 (D, F)	A	35	110	250	325		
	11 9 2	<b>24-20</b> 15 (A-D, G, L) 25 (E, F)	A	80	110	250	280		
	4	<b>24-22</b> 8	D	45	110	250	–		
	24	<b>24-28</b> 15	Inst.	80	110	250	280		
	22 18 4	<b>28-11</b> 15 (A-I, N-X) 25 (J-M)	A	80	110	250	280		
	26	<b>28-12</b> 15	A	90	180	270	–		
	35	<b>28-15</b> 15	A	80	110	250	280		
	14 4 10	<b>28-20</b> 15 (K-N) 25 (A-J, P)	A	80	110	250	280		
	37	<b>28-21</b> 15	A	80	110	250	280		
	9 5 4	<b>28A16</b> 16 4	Inst.	–	–	–	–	2 4 9 12	260 110 250 280



## CONTACT ARRANGEMENTS

### Contact count per contact arrangement

On pages 11–14 the contact arrangements are shown by shell sizes. The table below gives an overview on the number of contacts, contact size and per contact arrangement.

Contact Arrangement	No. of Contacts	Contact Size						
		10	15S	15	25	8	4	0
16-12	1						1	
20-2	1							1
10SL-4	2	2						
32-5	2							2
10SL-3	3	3						
14S-1	3	3						
14S-7	3	3						
16-7	3		2		1			
16-10	3			3				
20-19	3					3		
12SA10	4	4						
14S-2	4	4						
16-9	4		2	2				
18-4	4		4					
18-10	4			4				
18-13	4			3	1			
20-4	4			4				
22-22	4					4		
24-22	4					4		
32-17	4						4	
36-5	4							4
14S-5	5	5						
16S-8	5	5						
18-11	5			5				
22-12	5		3		2			
32-1	5			3				2
14S-6	6	6						
20-8	6		4		2			
14SA7	7	7						
16S-1	7	7						
18-9	7		5	2				
20-15	7			7				
24-2	7			7				
24-10	7				7			
20-7	8			8				
22-23	8			8				

Contact Arrangement	No. of Contacts	Contact Size						
		10	15S	15	25	8	4	0
20A9	9				9			
20-16	9			7	2			
24-11	9				6	3		
28A16	9			5			4	
18-1	10			10				
20-33	11			11				
24-20	11			9	2			
20-27	14			14				
22-19	14			14				
28-20	14			4	10			
24-7	16			14	2			
20-29	17			17				
20A48	19			19				
22-14	19			19				
28-11	22			18	4			
32-6	23			16	2	3	2	
24-28	24			24				
28-12	26			26				
28A63	28			19	9			
28-15	35			35				
32-7	35			28	7			
28-21	37			37				
36-10	48			48				
32A55	55			55				
32A69	61	41		20				

## MOUNTING HOLES

Shell size	CA-COM Threaded				CA-COM-Bayonet			Mounting holes for connectors styles, complete receptacle range
	d1 H12 CA00... , CA20...	d1 H12 CA02...	d2 H13	e	d1 H12 CA00... , CA20...	d1 H12 CA02...	d2 H13	
10SL	16,0	16,4	3,4	18,2	19,1	17,0	3,4	
12S	19,1	16,4	3,4	20,6	22,0	17,0	3,4	
14S	22,3	19,7	3,4	23,0	25,5	20,0	3,4	
16S/16	25,5	22,9	3,4	24,6	28,3	23,0	3,4	
18	28,7	26,1	3,4	27,0	31,7	26,5	3,4	
20	31,8	29,5	3,4	29,4	35,0	30,0	3,4	
22	35,0	32,7	3,4	31,8	38,3	33,0	3,4	
24	38,2	36,0	3,9	34,9	41,8	36,0	3,9	
28	44,5	42,0	3,9	39,7	47,6	42,0	3,9	
32	50,9	48,3	4,5	44,5	54,3	48,5	4,5	
36	57,2	53,1	4,5	49,2	60,5	55,0	4,5	

## HARNESSING

CA-COM connectors are designed for single wire harnessing, if an individual wire sealing grommet is used. Wires have to conform to wire and insulation diameters with the data given in the following table:

Contact size		Crimp/solder contacts		Insulation Ø	
AWG	metric mm	AWG	metric mm <sup>2</sup>	AWG	metric mm
-	10	-	0,75-1,0	-	1,45-2,5
16S/15S	16/15	16	0,75-1,5	1,6-2,8	1,60-2,8
12	25	12	2,5	2,9-3,5	2,9-3,5
-	60	-	6,0	-	3,5-4,9
8	100	8	10,0	4,2-5,8	5,5-6,5
4	160	4	16,0	6,2-9,0	7,1-9,0
0	500	0	50,0	10,5-13,0	10,5-13,0

## WIRE STRIPPING

Either mechanical or hot stripping can be used. Prevent conductors or insulators damage. For solder contacts, conductors have to be pretinned.

Note: Do not twist conductors used with crimp contacts. Do not touch uninsulated conductors before crimping, twisting of conductors and grease or lubricants on the wires cause poor crimp quality.

Contact size		Stripping length
AWG	metric	mm
-	10	4,0 + 0,4
16S/15S	16/15	6,0 + 0,5
12	25	6,0 + 0,5
8	60/100	11,0 + 0,8-0,4
4	160	11,0 + 0,8-0,4
0	500	13,0 + 0,8-0,4

## WIRING HINTS

Strip wires carefully. Do not damage conductors and insulation. For solder connections, wires have to be pretinned. Do not twist conductors used in crimp contacts, otherwise no perfect crimp connection will be achieved. Do not touch conductors before crimping. Film of grease or lubricants on the strands will cause poor crimp quality.

For detailed assembly instructions please visit [www.ittcannon.com](http://www.ittcannon.com) and search for the keyword "CA Bayonet Assembly Instruction".



## SEPARATING AND COUPLING DIMENSIONS

### PLUG

CA06COM-E  
CA06COM-E-B

CA06COM-E-DN  
CA06COM-E-B-03/-06

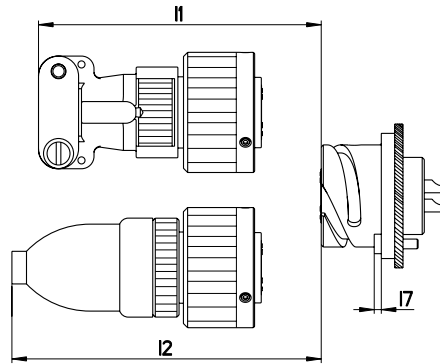

### RECEPTACLE

CA02COM-E  
CA02COM-E-B

### PLUG

CA06COM-F  
CA06COM-F-B

CA06COM-PG  
CA06COM-PG-B

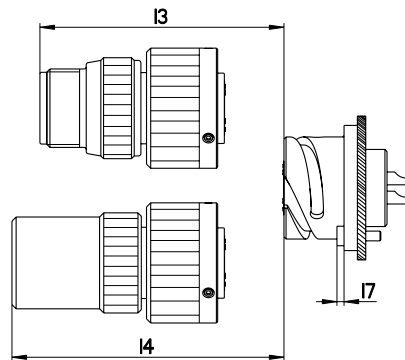

### RECEPTACLE

CA02COM-E  
CA02COM-E-B

### PLUG

CA08COM-E  
CA08COM-E-B

CA06COM-E-DN  
CA006COM-E-B

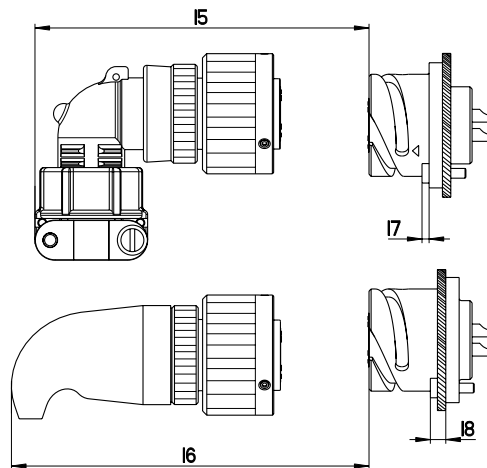

### RECEPTACLE

CA02COM-E  
CA20COM-E

CA02COM-E-B  
CA20COM-E-B

Shell size	I1 min	I2 min	I3 min	I4 min	I5 min	I6 min	I7 max	I8 max
10SL	70	70	65	80	70	65	3,5	8,0
12S	70	75	65	80	75	70	3,5	8,0
14S	70	75	65	80	75	80	3,5	8,0
16S	70	90	65	80	80	80	3,5	8,0
16	80	100	70	100	90	100	3,5	8,0
18	90	100	70	110	95	110	3,5	8,0
20	90	100	70	110	95	110	3,5	8,0
22	90	100	70	110	95	110	3,5	8,0
24	110	120	90	120	105	120	5,0	8,0
28	110	120	90	120	105	120	5,0	9,0
32	110	180	90	120	115	120	6,0	9,0
36	110	190	100	130	120	130	6,0	9,0

Dimensions shown in mm | Specifications and dimensions subject to change

## WALL MOUNTING RECEPTACLE CLASS PG OR ME

### CA00COM-PG-B with bayonet coupling, CA00COM-ME-B

CA00COM-PG/ ME-B is a wall mounting receptacle for usage of PG or Metric glands. It mates with plugs CA06COM-B and CA08COM-B

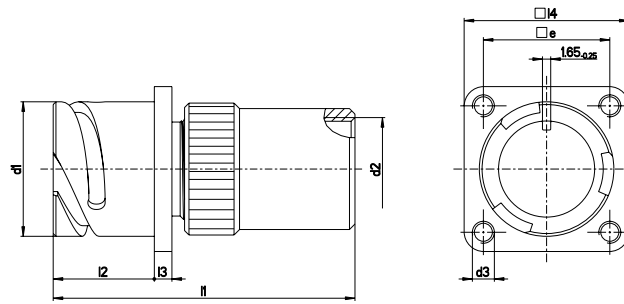

Part No. (pin insert*)	d1	d2	d3	l1	l2	l3	l4	e
	-0,15	PG-Thread Metric	Thread	max	+0,4	+0,2	±0,3	±0,1
CA00COM-PG10SL**P-B-*** CA00COM-ME10SL**P-B-***	18,2	PG9 M16 × 1,5	M4	56	18,20	2,8	25,4	18,2
CA00COM-PG12S**P-B-*** CA00COM-ME12S**P-B-***	21,4	PG9 M16 × 1,5	M4	56	18,20	3,2	28,0	20,6
CA00COM-PG14S**P-B-*** CA00COM-ME14S**P-B-***	24,6	PG11 M20 × 1,5	M4	56	18,20	3,2	30,0	23,0
CA00COM-PG16S**P-B-*** CA00COM-ME16S**P-B-***	27,4	PG13,5 M20 × 1,5	M4	58	18,20	3,2	32,5	24,6
CA00COM-PG16**P-B-*** CA00COM-ME16**P-B-***	27,4	PG13,5 M20 × 1,5	M4	66	23,05	3,2	32,5	24,6
CA00COM-PG18**P-B-*** CA00COM-ME18**P-B-***	30,8	PG13,5 M25 × 1,5	M4	73	23,05	4,0	35,0	27,0
CA00COM-PG20**P-B-*** CA00COM-ME20**P-B-***	34,2	PG16 M25 × 1,5	M4	74	23,05	4,0	38,0	29,4
CA00COM-PG22**P-B-*** CA00COM-ME22**P-B-***	37,4	PG16 M32 × 1,5	M4	77	23,05	4,0	41,0	31,8
CA00COM-PG24**P-B-*** CA00COM-ME24**P-B-***	40,9	PG16 M32 × 1,5	M4	77	23,05	4,0	44,5	34,9
CA00COM-PG28**P-B-*** CA00COM-ME28**P-B-***	46,7	PG21 M32 × 1,5	M5	78	24,05	4,0	50,8	39,7
CA00COM-PG32**P-B-*** CA00COM-ME32**P-B-***	53,4	PG29 M40 × 1,5	M5	78	24,05	4,0	57,0	44,5
CA00COM-PG36**P-B-*** CA00COM-ME36**P-B-***	59,6	PG29 M40 × 1,5	M5	89	24,05	4,0	63,5	49,2

### CA00COM-PG with threaded coupling, CA00COM-ME

CA00COM-PG / ME is a wall mounting receptacle for usage of PG or metric glands. It mates with plugs CA06COM and CA08COM

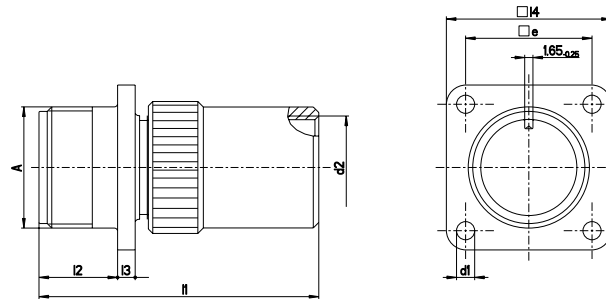

Part No. (pin insert*)	A	d1	d2	l1	l2	l3	l4	e
	Thread	+0,2/-0,1	PG-Thread Metric	max	+0,4	±0,3	±0,3	±0,1
CA00COM-PG10SL**P-*** CA00COM-ME10SL**P-***	5/8-24UNEF-2A	3,1	PG9 M16 × 1,5	52	14,2	2,8	25,4	18,2
CA00COM-PG12S**P-*** CA00COM-ME12S**P-***	3/4-20UNEF-2A	3,1	PG9 M16 × 1,5	52	14,2	3,2	28,0	20,6
CA00COM-PG14S**P-*** CA00COM-ME14S**P-***	7/8-20UNEF-2A	3,1	PG11 M20 × 1,5	52	14,2	3,2	30,0	23,0
CA00COM-PG16S**P-*** CA00COM-ME16S**P-***	1-20UNEF-2A	3,1	PG13,5 M20 × 1,5	54	14,2	3,2	32,5	24,6
CA00COM-PG16**P-*** CA00COM-ME16**P-***	1-20UNEF-2A	3,1	PG13,5 M20 × 1,5	64	19,0	3,2	32,5	24,6
CA00COM-PG18**P-*** CA00COM-ME18**P-***	1-1/8-18UNEF-2A	3,1	PG13,5 M25 × 1,5	69	19,0	4,0	35,0	27,0
CA00COM-PG20**P-*** CA00COM-ME20**P-***	1-1/4-18UNEF-2A	3,1	PG16 M25 × 1,5	70	19,0	4,0	38,0	29,4
CA00COM-PG22**P-*** CA00COM-ME22**P-***	1-3/8-18UNEF-2A	3,1	PG16 M32 × 1,5	73	19,0	4,0	41,0	31,8
CA00COM-PG24**P-*** CA00COM-ME24**P-***	1-1/2-18UNEF-2A	3,7	PG16 M32 × 1,5	74	20,6	4,0	44,5	34,9
CA00COM-PG28**P-*** CA00COM-ME28**P-***	1-3/4-18UNEF-2A	3,7	PG21 M32 × 1,5	74	20,6	4,0	50,8	39,7
CA00COM-PG32**P-*** CA00COM-ME32**P-***	2-18UNS-2A	4,4	PG29 M40 × 1,5	76	22,2	4,0	57,0	44,5
CA00COM-PG36**P-*** CA00COM-ME36**P-***	2-1/4-16UN-2A	4,4	PG29 M40 × 1,5	87	22,2	4,0	63,5	49,2

\*For socket inserts substitute "S" for "P" \*\*Add contact arrangement number; see pages 11-15 \*\*\* Add modification code; see page 10 (bottom)

## WALL MOUNTING RECEPTACLE CLASS E

### CA00COM-E-B with bayonet coupling

CA00COM-E-B is a wall mounting receptacle with endbell and cable clamp. It mates with plugs CA06COM-B and CA08COM-B

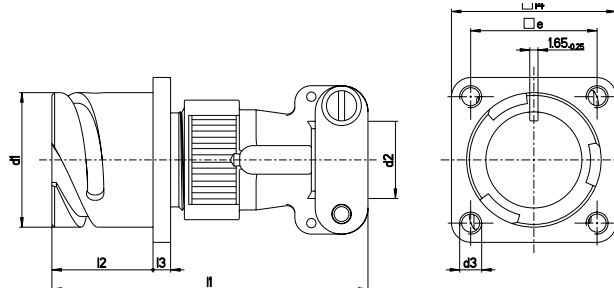

Part No. (pin insert*)	d1	d21	d3	l1	l2	l3	l4	e
	-0,15		Thread	max	+ 0,4	+ 0,2	± 0,3	± 0,1
CA00COM-E10SL-**P-B-***	18,2	7,9	M4	57	18,20	2,8	25,4	18,2
CA00COM-E12S-**P-B-***	21,4	7,9	M4	57	18,20	3,2	28,0	20,6
CA00COM-E14S-**P-B-***	24,6	11,1	M4	59	18,20	3,2	30,0	23,0
CA00COM-E16S-**P-B-***	27,4	14,2	M4	60	18,20	3,2	32,5	24,6
CA00COM-E16-**P-B-***	27,4	14,2	M4	68	23,05	3,2	32,5	24,6
CA00COM-E18-**P-B-***	30,8	15,8	M4	72	23,05	4,0	35,0	27,0
CA00COM-E20-**P-B-***	34,2	19,0	M4	72	23,05	4,0	38,0	29,4
CA00COM-E22-**P-B-***	37,4	19,0	M4	72	23,05	4,0	41,0	31,8
CA00COM-E24-**P-B-***	40,9	23,7	M4	78	23,05	4,0	44,5	34,9
CA00COM-E28-**P-B-***	46,7	23,7	M5	79	24,05	4,0	50,8	39,7
CA00COM-E32-**P-B-***	53,4	31,8	M5	78	24,05	4,0	57,0	44,5
CA00COM-E36-**P-B-***	59,6	34,6	M5	78	24,05	4,0	63,5	49,2

### CA00COM-E with threaded coupling

CA00COM-E is a wall mounting receptacle with endbell and cable clamp. It mates with plugs CA06COM and CA08COM

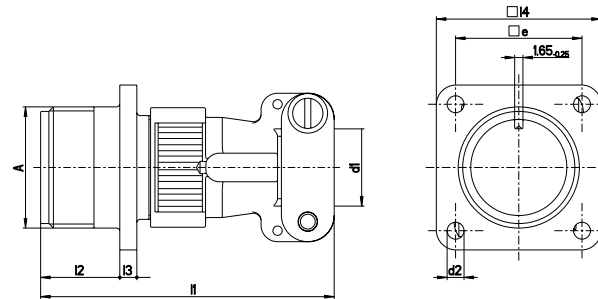

Part No. (pin insert*)	A	l1	l2	l3	l4	d1 <sup>1)</sup>	d2	e
	Thread	max	± 0,3	max	+ 0,2/-0,1	+ 0,4	+ 0,2/-0,1	± 0,3
CA00COM-E10SL-**P-***	5/8-24UNEF-2A	53	14,2	2,8	25,4	7,9	3,1	18,2
CA00COM-E12S-**P-***	3/4-20UNEF-2A	53	14,2	3,2	28,0	7,9	3,1	20,6
CA00COM-E14S-**P-***	7/8-20UNEF-2A	55	14,2	3,2	30,0	11,1	3,1	23,0
CA00COM-E16S-**P-***	1-20UNEF-2A	56	14,2	3,2	32,5	14,2	3,1	24,6
CA00COM-E16-**P-***	1-20UNEF-2A	66	19,0	3,2	32,5	14,2	3,1	24,6
CA00COM-E18-**P-***	1-1/8-18UNEF-2A	68	19,0	4,0	35,0	15,8	3,1	27,0
CA00COM-E20-**P-***	1-1/4-18UNEF-2A	68	19,0	4,0	38,0	19,0	3,1	29,4
CA00COM-E22-**P-***	1-3/8-18UNEF-2A	68	19,0	4,0	41,0	19,0	3,1	31,8
CA00COM-E24-**P-***	1-1/2-18UNEF-2A	76	20,6	4,0	44,5	23,7	3,7	34,9
CA00COM-E28-**P-***	1-3/4-18UNEF-2A	76	20,6	4,0	50,8	23,7	3,7	39,7
CA00COM-E32-**P-***	2-18UNS-2A	76	22,2	4,0	57,0	31,8	4,4	44,5
CA00COM-E36-**P-***	2-1/4-16UN-2A	76	22,2	4,0	63,5	34,6	4,4	49,2

\* For socket inserts substitute "S" for "P" \*\* Add contact arrangement number; see pages 11-15 \*\*\* Add modification code; see page 10 (bottom) <sup>1)</sup> max cable dia

## WALL MOUNTING RECEPTACLE CLASS F

### CA00COM-F-B with bayonet coupling

CA00COM-F-B is a wall mounting receptacle with endbell for flextubes. It mates with plugs CA06COM-B and CA08COM-B

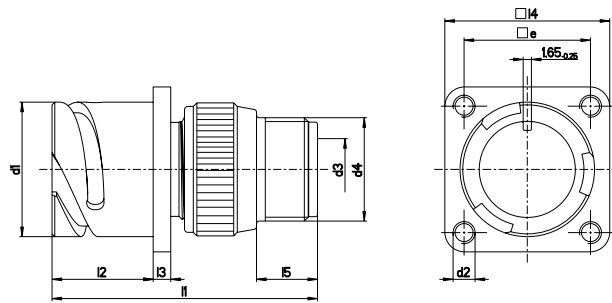

Part No. (pin insert*)	d1	d2	d3 <sup>1)</sup>	d4	l1	l2	l3	l4	l5	e
	-0,15	Thread		Thread	max	+ 0,4	± 0,2	± 0,3	min	± 0,1
CA00COM-F10SL-**-P-B-***	18,2	M4	8,2	5/8-24UNEF-2A	52	18,20	2,8	25,4	9,5	18,2
CA00COM-F12S-**-P-B-***	21,4	M4	8,2	5/8-20UNEF-2A	52	18,20	3,2	28,0	9,5	20,6
CA00COM-F14S-**-P-B-***	24,6	M4	11,1	3/4-20UNEF-2A	52	18,20	3,2	30,0	9,5	23,0
CA00COM-F16S-**-P-B-***	27,4	M4	14,3	7/8-20UNEF-2A	59	18,20	3,2	32,5	9,5	24,6
CA00COM-F16-**-P-B-***	27,4	M4	14,3	7/8-20UNEF-2A	59	23,05	3,2	32,5	9,5	24,6
CA00COM-F18-**-P-B-***	30,8	M4	16,7	1-20UNEF-2A	63	23,05	4,0	35,0	9,5	27,0
CA00COM-F20-**-P-B-***	34,2	M4	19,8	1-3/16-18UNEF-2A	63	23,05	4,0	38,0	9,5	29,4
CA00COM-F22-**-P-B-***	37,4	M4	19,8	1-3/16-18UNEF-2A	66	23,05	4,0	41,0	9,5	31,8
CA00COM-F24-**-P-B-***	40,9	M4	25,4	1-7/16-18UNEF-2A	69	23,05	4,0	44,5	9,5	34,9
CA00COM-F28-**-P-B-***	46,7	M5	27,0	1-7/16-18UNEF-2A	70	24,05	4,0	50,8	9,5	39,7
CA00COM-F32-**-P-B-***	53,4	M5	32,5	1-3/4-18UNS-2A	71	24,05	4,0	57,0	11,0	44,5
CA00COM-F36-**-P-B-***	59,6	M5	35,7	2-18UNS-2A	73	24,05	4,0	63,5	11,8	49,2

### CA00COM-F with threaded coupling

CA00COM-F is a wall mounting receptacle with endbell for flex tubes. It mates with plugs CA06COM and CA08COM

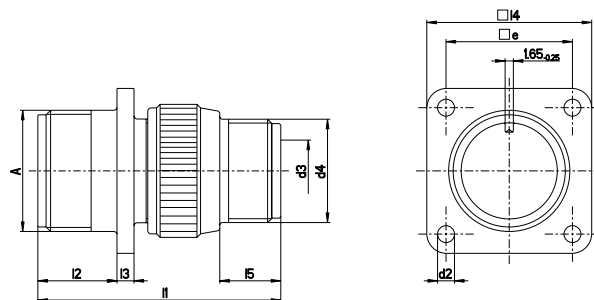

Part No. (pin insert*)	A	d2	d3 <sup>1)</sup>	d4	l1	l2	l3	l4	l5	e
	Thread	+ 0,2/-0,1		Thread	max	+ 0,4	± 0,3	± 0,3	min	± 0,1
CA00COM-F10SL-**-P-***	5/8-24UNEF-2A	3,1	8,2	5/8-24UNEF-2A	45	14,2	2,8	25,4	9,5	18,2
CA00COM-F12S-**-P-***	3/4-20UNEF-2A	3,1	8,2	5/8-20UNEF-2A	45	14,2	3,2	28,0	9,5	20,6
CA00COM-F14S-**-P-***	7/8-20UNEF-2A	3,1	11,1	3/4-20UNEF-2A	45	14,2	3,2	30,0	9,5	23,0
CA00COM-F16S-**-P-***	7/8-20UNEF-2A	3,1	14,3	7/8-20UNEF-2A	45	14,2	3,2	32,5	9,5	24,6
CA00COM-F16-**-P-***	1-20UNEF-2A	3,1	14,3	7/8-20UNEF-2A	54	19,0	3,2	32,5	9,5	24,6
CA00COM-F18-**-P-***	1-1/8-18UNEF-2A	3,1	16,7	1-20UNEF-2A	54	19,0	4,0	35,0	9,5	27,0
CA00COM-F20-**-P-***	1-1/4-18UNEF-2A	3,1	19,8	1-3/16-18UNEF-2A	55	19,0	4,0	38,0	9,5	29,4
CA00COM-F22-**-P-***	1-3/8-18UNEF-2A	3,1	19,8	1-3/16-18UNEF-2A	58	19,0	4,0	41,0	9,5	31,8
CA00COM-F24-**-P-***	1-1/2-18UNEF-2A	3,7	25,4	1-7/16-18UNEF-2A	59	20,6	4,0	44,5	9,5	34,9
CA00COM-F28-**-P-***	1-3/4-18UNEF-2A	3,7	27,0	1-7/16-18UNEF-2A	60	20,6	4,0	50,8	9,5	39,7
CA00COM-F32-**-P-***	2-18UNS-2A	4,4	32,5	1-3/4-18UNS-2A	62	22,2	4,0	57,0	11,0	44,5
CA00COM-F36-**-P-***	2-1/4-16UN-2A	4,4	35,7	2-18UNS-2A	64	22,2	4,0	63,5	11,8	49,2

\* For socket inserts substitute "S" for "P" \*\*Add contact arrangement number; see pages 11-15 \*\*\* Add modification code; see page 10 (bottom) <sup>1)</sup>max cable dia



## WALL MOUNTING RECEPTACLE CLASS E

### CA00COM-E-B/-03/-06 with bayonet coupling

CA00COM-E-B/-03/-06 is a wall mounting receptacle (wire sealing) for heat shrink boots. It mates with plugs CA06COM-B and CA08COM-B

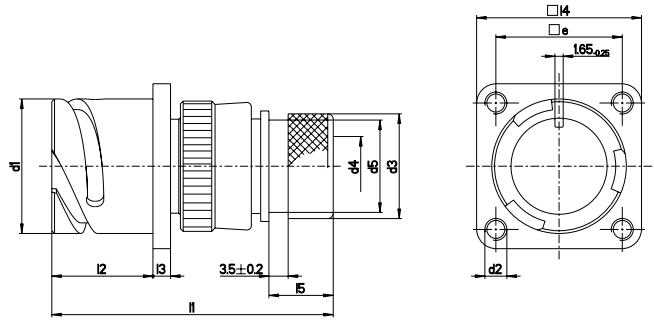

Part No. (pin insert*)	d1	d2	d3	d4 <sup>1)</sup>	d5	l1	l2	l3	l4	l5	e
	-0,15	Thread	± 0,2		max	max	+ 0,4	± 0,3	± 0,3	± 0,5	± 0,1
CA00COM-E10SL-**P-B-***	18,2	M4	15,5	7,7	13,3	53	18,20	2,8	25,4	11,7	18,2
CA00COM-E12S-**P-B-***	21,4	M4	15,5	7,9	13,3	53	18,20	3,2	28,0	11,7	20,6
CA00COM-E14S-**P-B-***	24,6	M4	19,1	10,6	17,0	53	18,20	3,2	30,0	11,7	23,0
CA00COM-E16S-**P-B-***	27,4	M4	23,9	13,5	21,9	53	18,20	3,2	32,5	11,7	24,6
CA00COM-E16-**P-B-***	27,4	M4	23,9	13,5	21,9	61	23,05	3,2	32,5	11,5	24,6
CA00COM-E18-**P-B-***	30,8	M4	23,9	14,6	21,9	62	23,05	4,0	35,0	11,5	27,0
CA00COM-E20-**P-B-***	34,2	M4	29,6	14,6	26,2	64	23,05	4,0	38,0	12,7	29,4
CA00COM-E22-**P-B-***	37,4	M4	29,6	20,8	26,2	64	23,05	4,0	41,0	12,7	31,8
CA00COM-E24-**P-B-***	40,9	M4	37,8	24,6	34,5	64	23,05	4,0	44,5	12,7	34,9
CA00COM-E28-**P-B-***	46,7	M5	37,8	27,0	34,5	66	24,05	4,0	50,8	12,7	39,7
CA00COM-E32-**P-B-***	53,4	M5	47,8	33,3	43,6	69	24,05	4,0	57,0	15,2	44,5
CA00COM-E36-**P-B-***	59,6	M5	47,8	38,5	43,6	70	24,05	4,0	63,5	15,2	49,2

### CA00COM-E-DN with threaded coupling

CA00COM-E-DN is a wall mounting receptacle with endbell (wire sealing) for heat shrink boots. It mates with plugs CA06COM and CA08COM

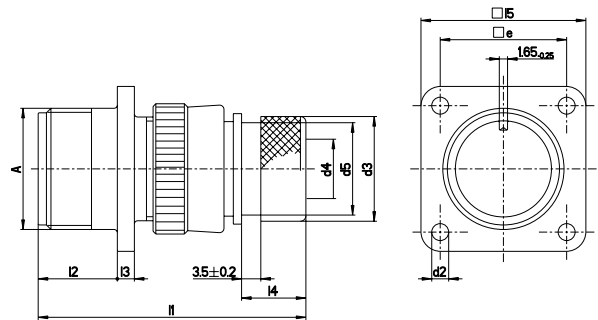

Part No. (pin insert*)	A	d2	d3	d4 <sup>1)</sup>	d5	l1	l2	l3	l4	l5	e
	Thread	+ 0,2/- 0,1	± 0,2		max	max	+ 0,4	± 0,3	± 0,5	± 0,3	± 0,1
CA00COM-E10SL-**P-DN	5/8-24UNEF-2A	3,1	15,5	7,7	13,3	49,0	14,2	2,8	11,7	25,4	18,2
CA00COM-E12S-**P-DN	3/4-20UNEF-2A	3,1	15,5	7,9	13,3	49,0	14,2	3,2	11,7	28,0	20,6
CA00COM-E14S-**P-DN	7/8-20UNEF-2A	3,1	19,1	10,6	17,0	49,0	14,2	3,2	11,7	30,0	23,0
CA00COM-E16S-**P-DN	1-20UNEF-2A	3,1	23,9	13,5	21,9	49,0	14,2	3,2	11,7	32,5	24,6
CA00COM-E16-**P-DN	1-20UNEF-2A	3,1	23,9	13,5	21,9	58,0	19,0	3,2	11,5	32,5	24,6
CA00COM-E18-**P-DN	1-1/8-18UNEF-2A	3,1	23,9	14,6	21,9	58,0	19,0	4,0	11,5	35,0	27,0
CA00COM-E20-**P-DN	1-1/4-18UNEF-2A	3,1	23,9	14,6	26,2	60,0	19,0	4,0	12,7	35,0	27,0
CA00COM-E22-**P-DN	1-3/8-18UNEF-2A	3,1	29,6	20,8	26,2	60,0	19,0	4,0	12,7	41,0	31,8
CA00COM-E24-**P-DN	1-1/2-18UNEF-2A	3,7	37,8	24,6	34,5	63,0	20,6	4,0	12,7	44,5	34,9
CA00COM-E28-**P-DN	1-3/4-18UNEF-2A	3,7	37,8	27,0	34,5	63,0	20,6	4,0	12,7	50,8	39,7
CA00COM-E32-**P-DN	2-18UNS-2A	4,4	47,8	33,3	43,6	67,0	22,2	4,0	15,2	57,0	44,5
CA00COM-E36-**P-DN	2-1/4-16UN-2A	4,4	47,8	38,5	43,6	68,0	22,2	4,0	15,2	63,5	49,2

\*For socket inserts substitute "S" for "P" \*\*Add contact arrangement number; see pages 11–15 \*\*\*-03: with metric crimp contacts/-06: with solder pot contacts <sup>1)</sup>max cable dia

## CABLE CONNECTING PLUG CLASS PG OR ME

### CA01COM-PG-B with bayonet coupling, CA01COM-ME-B

CA01COM-PG/ME-B is a cable connecting plug for usage of PG or metric glands. It mates with plugs CA06COM-B and CA08COM-B

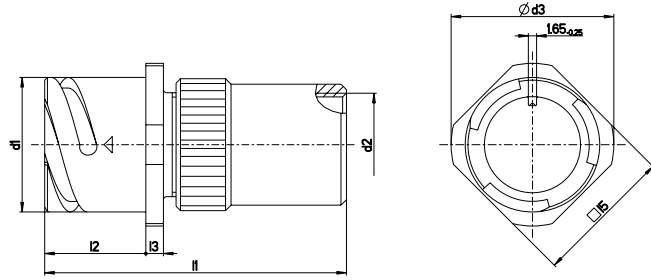

Part No. PG (pin insert*)	Part No. ME (pin insert*)	d1 -0,15	d2		d3 max	l1 max	l2 +0,4	l3 +0,2	l5 ±0,2
			PG-Thread	Metric					
CA01COM-PG10SL-**P-B-***	CA01COM-ME10SL-**P-B-***	18,2	PG9	M16 × 1,5	25,2	56	18,2	2,8	20,6
CA01COM-PG12S-**P-B-***	CA01COM-ME12S-**P-B-***	21,4	PG9	M16 × 1,5	27,8	56	18,20	3,2	23,8
CA01COM-PG14S-**P-B-***	CA01COM-ME14S-**P-B-***	24,6	PG11	M20 × 1,5	29,8	56	18,20	3,2	25,4
CA01COM-PG16S-**P-B-***	CA01COM-ME16S-**P-B-***	27,4	PG13,5	M20 × 1,5	32,3	58	18,20	3,2	28,6
CA01COM-PG16-**P-B-***	CA01COM-ME16-**P-B-***	27,4	PG13,5	M20 × 1,5	32,3	66	23,05	3,2	28,6
CA01COM-PG18-**P-B-***	CA01COM-ME18-**P-B-***	30,8	PG13,5	M25 × 1,5	34,8	73	23,05	4,0	31,7
CA01COM-PG20-**P-B-***	CA01COM-ME20-**P-B-***	34,2	PG16	M25 × 1,5	37,8	74	23,05	4,0	34,9
CA01COM-PG22-**P-B-***	CA01COM-ME22-**P-B-***	37,4	PG16	M32 × 1,5	41,1	77	23,05	4,0	38,1
CA01COM-PG24-**P-B-***	CA01COM-ME24-**P-B-***	40,9	PG16	M32 × 1,5	44,6	77	23,05	4,0	41,3
CA01COM-PG28-**P-B-***	CA01COM-ME28-**P-B-***	46,7	PG21	M32 × 1,5	50,9	78	24,05	4,0	47,6
CA01COM-PG32-**P-B-***	CA01COM-ME32-**P-B-***	53,4	PG29	M40 × 1,5	57,1	78	24,05	4,0	54,0
CA01COM-PG36-**P-B-***	CA01COM-ME36-**P-B-***	59,6	PG29	M40 × 1,5	63,6	89	24,05	4,0	60,6

### CA01COM-PG with threaded coupling

CA01COM-PG/ME is a cable connecting plug for usage of PG or metric glands. It mates with plugs CA06COM and CA08COM

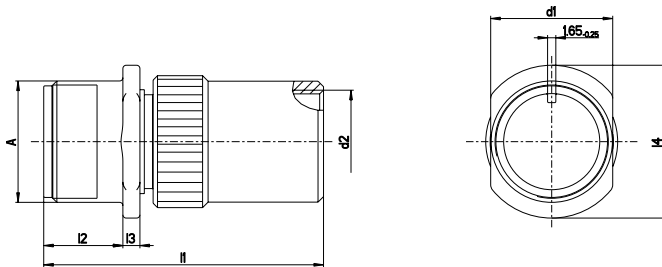

Part No. PG (pin insert*)	Part No. ME (pin insert*)	A	d1	d2		l1	l2	l3	l4
		Thread	max	PG-Thread	Metric	max	+0,4	±0,3	max
CA01COM-PG10SL-**P-***	CA01COM-ME10SL-**P-***	5/8-24UNEF-2A	16,2	PG9	M16 × 1,5	52	14,2	2,8	21,8
CA01COM-PG12S-**P-***	CA01COM-ME12S-**P-***	3/4-20UNEF-2A	19,4	PG9	M16 × 1,5	52	14,2	3,2	25,0
CA01COM-PG14S-**P-***	CA01COM-ME14S-**P-***	7/8-20UNEF-2A	22,5	PG11	M20 × 1,5	52	14,2	3,2	28,2
CA01COM-PG16S-**P-***	CA01COM-ME16S-**P-***	1-20UNEF-2A	25,7	PG13,5	M20 × 1,5	54	14,2	3,2	31,4
CA01COM-PG16-**P-***	CA01COM-ME16-**P-***	1-20UNEF-2A	25,7	PG13,5	M20 × 1,5	64	19,0	3,2	31,4
CA01COM-PG18-**P-***	CA01COM-ME18-**P-***	1-1/8-18UNEF-2A	28,9	PG13,5	M25 × 1,5	69	19,0	4,0	34,5
CA01COM-PG20-**P-***	CA01COM-ME20-**P-***	1-1/4-18UNEF-2A	32,1	PG16	M25 × 1,5	70	19,0	4,0	37,3
CA01COM-PG22-**P-***	CA01COM-ME22-**P-***	1-3/8-18UNEF-2A	35,2	PG16	M32 × 1,5	73	19,0	4,0	40,9
CA01COM-PG24-**P-***	CA01COM-ME24-**P-***	1-1/2-18UNEF-2A	38,4	PG16	M32 × 1,5	74	20,6	4,0	43,8
CA01COM-PG28-**P-***	CA01COM-ME28-**P-***	1-3/4-18UNEF-2A	44,8	PG21	M32 × 1,5	74	20,6	4,0	50,4
CA01COM-PG32-**P-***	CA01COM-ME32-**P-***	2-18UNS-2A	51,1	PG29	M40 × 1,5	76	22,2	4,0	56,8
CA01COM-PG36-**P-***	CA01COM-ME36-**P-***	2-1/4-16UN-2A	57,5	PG29	M40 × 1,5	87	22,2	4,0	63,1

\*For socket inserts substitute "S" for "P" \*\*Add contact arrangement number; see pages 11–15 \*\*\*Add modification code; see page 10 (bottom)

## CABLE CONNECTING PLUG CLASS E

### CA01COM-E-B with bayonet coupling

CA01COM-E-B is a cable connecting plug with endbell and cable clamp. It mates with plugs CA06COM-B and CA08COM-B

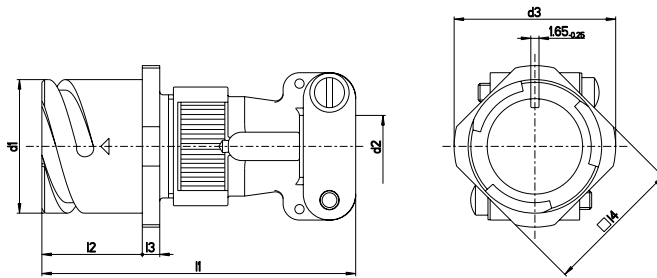

Part No. (pin insert)	d1	d2 <sup>1)</sup>	d3	l1	l2	l3	l4
	-0,15		max	max	+ 0,4	± 0,2	± 0,2
CA01COM-E10SL-**P-B-***	18,2	7,9	25,2	57	18,20	2,8	20,6
CA01COM-E12S-**P-B-***	21,4	7,9	27,8	57	18,20	3,2	23,8
CA01COM-E14S-**P-B-***	24,6	11,1	29,8	59	18,20	3,2	25,4
CA01COM-E16S-**P-B-***	27,4	14,2	32,3	60	18,20	3,2	28,6
CA01COM-E16-**P-B-***	27,4	14,2	32,3	68	23,05	3,2	28,6
CA01COM-E18-**P-B-***	30,8	15,8	34,8	72	23,05	4,0	31,7
CA01COM-E20-**P-B-***	34,2	19,0	37,8	72	23,05	4,0	34,9
CA01COM-E22-**P-B-***	37,4	19,0	41,1	72	23,05	4,0	38,1
CA01COM-E24-**P-B-***	40,9	23,7	44,6	78	23,05	4,0	41,3
CA01COM-E28-**P-B-***	46,7	23,7	50,9	79	24,05	4,0	47,6
CA01COM-E32-**P-B-***	53,4	31,8	57,1	78	24,05	4,0	54,0
CA01COM-E36-**P-B-***	59,6	34,6	63,6	78	24,05	4,0	60,6

### CA01COM-E with threaded coupling

CA01COM-E is a cable connecting plug with endbell and cable clamp. It mates with plugs CA06COM and CA08COM

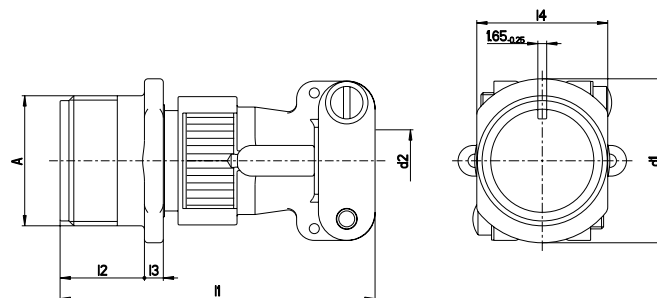

Part No. (pin insert)	A	d1	d2 <sup>1)</sup>	l1	l2	l3	l4
	Thread	max		max	+ 0,4	± 0,3	max
CA01COM-E10SL-**P-***	5/8-24UNEF-2A	21,8	7,9	53	14,2	2,8	16,2
CA01COM-E12S-**P-***	3/4-20UNEF-2A	25,0	7,9	53	14,2	3,2	19,4
CA01COM-E14S-**P-***	7/8-20UNEF-2A	28,2	11,1	55	14,2	3,2	22,5
CA01COM-E16S-**P-***	1-20UNEF-2A	31,4	14,2	56	14,2	3,2	25,7
CA01COM-E16-**P-***	1-20UNEF-2A	31,4	14,2	66	19,0	3,2	25,7
CA01COM-E18-**P-***	1-1/8-18UNEF-2A	34,5	15,8	68	19,0	4,0	28,9
CA01COM-E20-**P-***	1-1/4-18UNEF-2A	37,3	19,0	68	19,0	4,0	32,1
CA01COM-E22-**P-***	1-3/8-18UNEF-2A	40,9	19,0	68	19,0	4,0	35,2
CA01COM-E24-**P-***	1-1/2-18UNEF-2A	43,8	23,7	76	20,6	4,0	38,4
CA01COM-E28-**P-***	1-3/4-18UNEF-2A	50,4	23,7	76	20,6	4,0	44,8
CA01COM-E32-**P-***	2-18UNS-2A	56,8	31,8	76	22,2	4,0	51,1
CA01COM-E36-**P-***	2-1/4-16UN-2A	63,1	34,6	76	22,2	4,0	57,5

\*For socket inserts substitute "S" for "P" \*\*Add contact arrangement number; see pages 11–15 \*\*\* Add modification code; see page 10 (bottom) <sup>1)</sup>max cable dia

## CABLE CONNECTING PLUG CLASS E

### CA01COM-E-B/-03/-06 with bayonet coupling

CA01COM-E-B/-03/-06 is a cable connecting plug with endbell (wire sealing) for heat shrink boots. It mates with plugs CA06COM-B and CA08COM-B

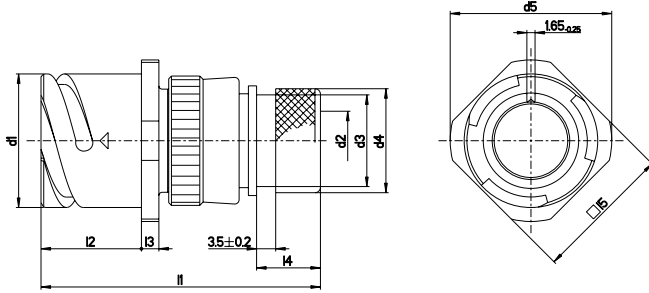

Part No. (pin insert*)	d1	d2 <sup>1)</sup>	d3	d4	d5	l1	l2	l3	l4	l5
	-0,15	max	max	± 0,2	max	max	+ 0,4	± 0,3	± 0,5	± 0,2
CA01COM-E10SL-**-P-B-***	18,2	7,7	13,3	15,5	25,2	53	18,20	2,8	11,7	20,6
CA01COM-E12S-**-P-B-***	21,4	7,9	13,3	15,5	27,8	53	18,20	3,2	11,7	23,8
CA01COM-E14S-**-P-B-***	24,6	10,6	17,0	19,1	29,8	53	18,20	3,2	11,7	25,4
CA01COM-E16S-**-P-B-***	27,4	13,5	21,9	23,9	32,3	53	18,20	3,2	11,7	28,6
CA01COM-E16-**-P-B-***	27,4	13,5	21,9	23,9	32,3	61	23,05	3,2	11,5	28,6
CA01COM-E18-**-P-B-***	30,8	14,6	21,9	23,9	34,8	62	23,05	4,0	11,5	31,7
CA01COM-E20-**-P-B-***	34,2	18,7	26,2	29,6	37,8	64	23,05	4,0	12,7	34,9
CA01COM-E22-**-P-B-***	37,4	20,8	26,2	29,6	41,1	64	23,05	4,0	12,7	38,1
CA01COM-E24-**-P-B-***	40,9	24,6	34,5	37,8	44,6	64	23,05	4,0	12,7	41,3
CA01COM-E28-**-P-B-***	46,7	27,0	34,5	37,8	50,9	66	24,05	4,0	12,7	47,6
CA01COM-E32-**-P-B-***	53,4	33,3	43,6	47,8	57,1	69	24,05	4,0	15,2	54,0
CA01COM-E36-**-P-B-***	59,6	38,5	43,6	47,8	63,6	70	24,05	4,0	15,2	60,6

### CA01COM-E-DN with threaded coupling

CA01COM-E-DN is a cable connecting plug with endbell (wire sealing) for heat shrink boots. It mates with plugs CA06COM and CA08COM

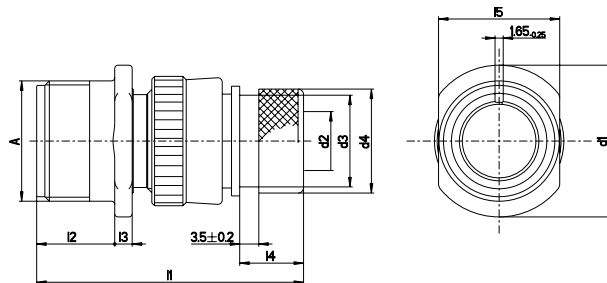

Part No. (pin insert*)	A	d1	d2 <sup>1)</sup>	d3	d4	l1	l2	l3	l4	l5
	Thread	max	max	± 0,5	± 0,2	max	± 0,3	± 0,3	max	± 0,2
CA01COM-E10SL-**-P-DN	5/8-24UNEF-2A	21,8	7,7	15,5	15,5	49,0	14,2	2,8	11,7	16,2
CA01COM-E12S-**-P-DN	3/4-20UNEF-2A	25,0	7,9	15,5	15,5	49,0	14,2	3,2	11,7	19,4
CA01COM-E14S-**-P-DN	7/8-20UNEF-2A	28,2	10,6	19,1	19,1	49,0	14,2	3,2	11,7	22,5
CA01COM-E16S-**-P-DN	1-20UNEF-2A	31,4	13,5	23,9	23,9	49,0	14,1	3,2	11,7	25,7
CA01COM-E16-**-P-DN	1-20UNEF-2A	31,4	13,5	23,9	23,9	58,0	19,0	3,2	11,5	25,7
CA01COM-E18-**-P-DN	1-1/8-18UNEF-2A	34,5	14,6	23,9	23,9	58,0	19,0	4,0	11,5	28,9
CA01COM-E20-**-P-DN	1-1/4-18UNEF-2A	37,3	18,7	29,6	29,6	60,0	19,0	4,0	12,7	32,1
CA01COM-E22-**-P-DN	1-3/8-18UNEF-2A	40,9	20,8	29,6	29,6	60,0	19,0	4,0	12,7	35,2
CA01COM-E24-**-P-DN	1-1/2-18UNEF-2A	43,8	24,6	37,8	37,8	63,0	20,6	4,0	12,7	38,4
CA01COM-E28-**-P-DN	1-3/4-18UNEF-2A	50,4	27,0	37,8	37,8	63,0	20,6	4,0	12,7	44,8
CA01COM-E32-**-P-DN	2-18UNS-2A	56,8	33,3	47,8	47,8	67,0	22,2	4,0	15,2	51,1
CA01COM-E36-**-P-DN	2-1/4-16UN-2A	63,1	38,5	47,8	47,8	68,0	22,2	4,0	15,2	57,5

\* For socket inserts substitute "S" for "P" \*\* Add contact arrangement number; see pages 11–15 \*\*\* -03: with metric crimp contacts / -06: with solder pot contacts <sup>1)</sup> max cable dia

## CABLE CONNECTING PLUG CLASS F

### CA01COM-F-B with bayonet coupling

CA01COM-F-B is a cable connecting plug for flex tube. It mates with plugs CA06COM-B and CA08COM-B

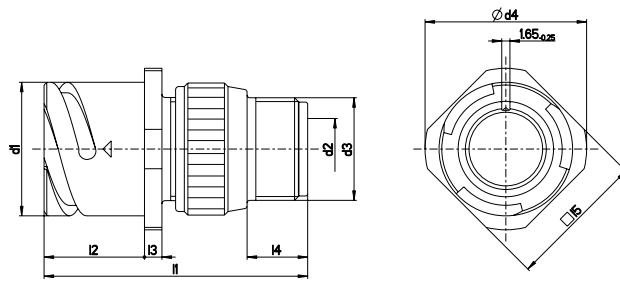

Part No. (pin insert*)	d1	d2 <sup>1)</sup>	d3	d4	l1	l2	l3	l4	l5
	-0,15		Thread	max	max	+ 0,4	± 0,2	min	± 0,2
CA01COM-F10SL-**P-B-***	18,2	8,2	5/8-24UNEF-2A	25,2	50	18,20	2,8	9,5	20,6
CA01COM-F12S-**P-B-***	18,2	8,2	5/8-20UNEF-2A	27,8	50	18,20	3,2	9,5	23,8
CA01COM-F14S-**P-B-***	24,6	11,1	3/4-20UNEF-2A	29,8	50	18,20	3,2	9,5	25,4
CA01COM-F16S-**P-B-***	27,4	14,3	7/8-20UNEF-2A	32,3	50	18,20	3,2	9,5	28,6
CA01COM-F16-**P-B-***	27,4	14,3	7/8-20UNEF-2A	32,3	57	23,05	3,2	9,5	28,6
CA01COM-F18-**P-B-***	30,8	16,7	1-20UNEF-2A	34,8	59	23,05	4,0	9,5	31,7
CA01COM-F20-**P-B-***	34,2	19,8	1-3/16-18UNEF-2A	37,8	59	23,05	4,0	9,5	34,9
CA01COM-F22-**P-B-***	37,4	19,8	1-3/16-18UNEF-2A	41,1	62	23,05	4,0	9,5	38,1
CA01COM-F24-**P-B-***	40,9	25,4	1-7/16-18UNEF-2A	44,6	62	23,05	4,0	9,5	41,3
CA01COM-F28-**P-B-***	46,7	27,0	1-7/16-18UNEF-2A	50,9	64	24,05	4,0	9,5	47,6
CA01COM-F32-**P-B-***	53,4	32,5	1-3/4-18UNS-2A	57,1	64	24,05	4,0	11,0	54,0
CA01COM-F36-**P-B-***	59,6	35,7	2-18UNS-2A	63,6	66	24,05	4,0	11,8	60,6

### CA01COM-F with threaded coupling

CA01COM-F is a cable connecting plug for flex tube. It mates with plugs CA06COM and CA08COM

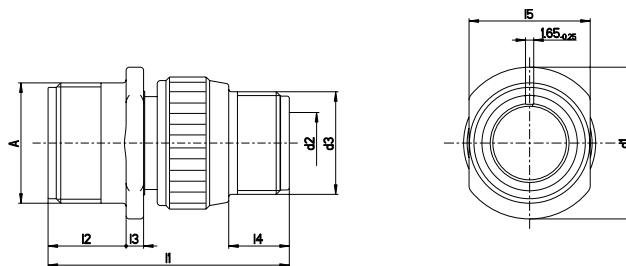

Part No. (pin insert*)	A	d1	d2 <sup>1)</sup>	d3	l1	l2	l3	l4	l5
	Thread	max		Thread	max	+ 0,4	± 0,3	min	± 0,2
CA01COM-F10SL-**P-***	5/8-24UNEF-2A	21,8	8,2	5/8-24UNEF-2A	45	14,2	2,8	9,5	16,2
CA01COM-F12S-**P-***	3/4-20UNEF-2A	25,0	8,2	5/8-20UNEF-2A	45	14,2	3,2	9,5	19,4
CA01COM-F14S-**P-***	7/8-20UNEF-2A	28,2	11,1	3/4-20UNEF-2A	45	14,2	3,2	9,5	22,5
CA01COM-F16S-**P-***	1-20UNEF-2A	31,4	14,3	7/8-20UNEF-2A	45	14,2	3,2	9,5	25,7
CA01COM-F16-**P-***	1-20UNEF-2A	31,4	14,3	7/8-20UNEF-2A	54	14,2	3,2	9,5	25,7
CA01COM-F18-**P-***	1-1/8-18UNEF-2A	34,5	16,7	1-20UNEF-2A	54	19,0	4,0	9,5	28,9
CA01COM-F20-**P-***	1-1/4-18UNEF-2A	37,3	19,8	1-3/16-18UNEF-2A	55	19,0	4,0	9,5	32,1
CA01COM-F22-**P-***	1-3/8-18UNEF-2A	40,9	19,8	1-3/16-18UNEF-2A	58	20,6	4,0	9,5	35,2
CA01COM-F24-**P-***	1-1/2-18UNEF-2A	43,8	25,4	1-7/16-18UNEF-2A	59	20,6	4,0	9,5	38,4
CA01COM-F28-**P-***	1-3/4-18UNEF-2A	50,4	27,0	1-7/16-18UNEF-2A	60	20,6	4,0	9,5	44,8
CA01COM-F32-**P-***	2-18UNS-2A	56,8	32,5	1-3/4-18UNS-2A	62	22,2	4,0	11,0	51,1
CA01COM-F36-**P-***	2-1/4-16UN-2A	63,1	35,7	2-18UNS-2A	64	22,2	4,0	11,8	57,5

\*For socket inserts substitute "S" for "P" \*\*Add contact arrangement number; see pages 11–15 \*\*\* Add modification code; see page 10 (bottom) <sup>1)</sup>max cable dia

## BOX MOUNTING RECEPTACLE CLASS E

### CA02COM-E-B with bayonet coupling

CA02COM-E-B is a box mounting receptacle for front panel mounting. It mates with plugs CA06COM-B and CA08COM-B

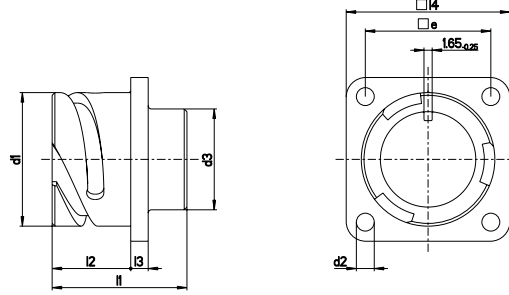

Part No. (pin insert*)	d1	d2	d3	l1	l2	l3	l4	e
	-0,15	H13	max.	± 0,3	+ 0,4	± 0,2	± 0,3	± 0,1
CA02COM-E10SL-**-P-B-***	18,2	3.1	16,2	24,7	14,2	2,8	25,4	18,2
CA02COM-E12S-**-P-B-***	21,4	3.1	16,2	24,7	14,2	3,2	28,0	20,6
CA02COM-E14S-**-P-B-***	24,6	3.1	19,2	24,7	14,2	3,2	30,0	23,0
CA02COM-E16S-**-P-B-***	27,4	3.1	22,4	24,7	14,2	3,2	32,5	24,6
CA02COM-E16-**-P-B-***	27,4	3.1	22,4	33,8	19,0	3,2	32,5	24,6
CA02COM-E18-**-P-B-***	30,8	3.1	25,6	33,8	19,0	4,0	35,0	27,0
CA02COM-E20-**-P-B-***	34,2	3.1	29,0	33,8	19,0	4,0	38,0	29,4
CA02COM-E22-**-P-B-***	37,4	3.1	32,2	33,8	19,0	4,0	41,0	31,8
CA02COM-E24-**-P-B-***	40,9	3.7	35,3	33,8	20,6	4,0	44,5	34,9
CA02COM-E28-**-P-B-***	46,7	3.7	41,4	33,8	20,6	4,0	50,8	39,7
CA02COM-E32-**-P-B-***	53,4	4.4	47,8	33,8	22,2	4,0	57,0	44,5
CA02COM-E36-**-P-B-***	59,6	4.4	52,6	33,8	22,2	4,0	63,5	49,2

### CA02COM-E with threaded coupling

CA02COM-E is a boxmounting receptacle for front panel mounting. It mates with plugs CA06COM and CA08COM

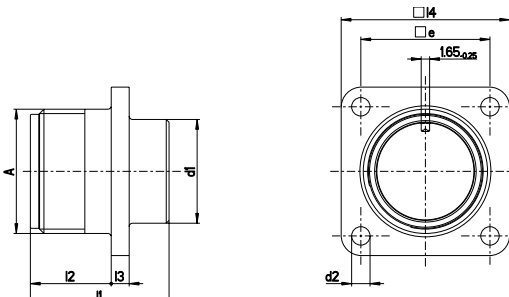

Part No. (pin insert*)	A	d1	d2	l1	l2	l3	l4	e
	Thread	max.	+ 0,2	max.	+ 0,4	± 0,3	± 0,3	± 0,1
CA02COM-E10SL-**-P-***	5/8-24UNEF-2A	15,9	3,1	25,1	14,2	2,8	25,4	18,2
CA02COM-E12S-**-P-***	3/4-20UNEF-2A	15,9	3,1	25,1	14,2	3,2	28,0	20,6
CA02COM-E14S-**-P-***	7/8-20UNEF-2A	19,0	3,1	25,1	14,2	3,2	30,0	23,0
CA02COM-E16S-**-P-***	1-20UNEF-2A	22,2	3,1	25,1	14,2	3,2	32,5	24,6
CA02COM-E16-**-P-***	1-20UNEF-2A	22,2	3,1	34,2	19,0	3,2	32,5	24,6
CA02COM-E18-**-P-***	1-1/8-18UNEF-2A	25,4	3,1	34,2	19,0	4,0	35,0	27,0
CA02COM-E20-**-P-***	1-1/4-18UNEF-2A	29,0	3,1	34,2	19,0	4,0	38,0	29,4
CA02COM-E22-**-P-***	1-3/8-18UNEF-2A	32,2	3,1	34,2	19,0	4,0	41,0	31,8
CA02COM-E24-**-P-***	1-1/2-18UNEF-2A	35,3	3,7	34,2	20,6	4,0	44,5	34,9
CA02COM-E28-**-P-***	1-3/4-18UNEF-2A	41,2	3,7	34,2	20,6	4,0	50,8	39,7
CA02COM-E32-**-P-***	2-18UNS-2A	47,6	4,4	34,2	22,2	4,0	57,0	44,5
CA02COM-E36-**-P-***	2-1/4-16UN-2A	52,4	4,4	34,2	22,2	4,0	63,5	49,2

\*For socket inserts substitute "S" for "P" \*\*Add contact arrangement number; see pages 11–15 \*\*\* Add modification code; see page 10 (bottom) <sup>1)</sup>max cable dia



## BOX MOUNTING RECEPTACLE CLASS E

### CA20COM-E-B with bayonet coupling

CA20COM-E-B is a box mounting receptacle for rear panel mounting. It mates with plugs CA06COM-B and CA08COM-B

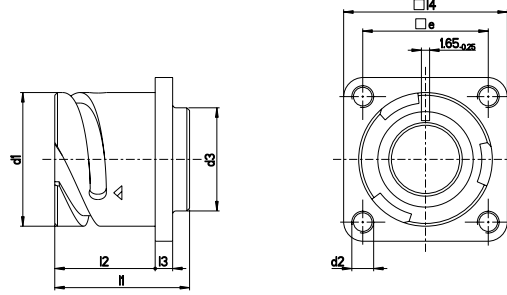

Part No. (pin insert*)	d1	d2	d3	l1	l2	l3	l4	e
	-0,15		max.	± 0,3	+ 0,4	± 0,2	± 0,3	± 0,0
CA20COM-E10SL-**-P-B-***	18,2	M4	16,2	24,7	18,20	2,8	25,4	18,2
CA20COM-E12S-**-P-B-***	21,4	M4	16,2	24,7	18,20	3,2	28,0	20,6
CA20COM-E14S-**-P-B-***	24,6	M4	19,2	24,7	18,20	3,2	30,0	23,0
CA20COM-E16S-**-P-B-***	27,4	M4	22,4	24,7	18,20	3,2	32,5	24,6
CA20COM-E16-**-P-B-***	27,4	M4	22,4	33,8	23,05	3,2	32,5	24,6
CA20COM-E18-**-P-B-***	30,8	M4	25,6	33,8	23,05	4,0	35,0	27,0
CA20COM-E20-**-P-B-***	34,2	M4	29,0	33,8	23,05	4,0	38,0	29,4
CA20COM-E22-**-P-B-***	37,4	M4	32,2	33,8	23,05	4,0	41,0	31,8
CA20COM-E24-**-P-B-***	40,9	M4	35,3	33,8	23,05	4,0	44,5	34,9
CA20COM-E28-**-P-B-***	46,7	M5	41,4	33,8	24,05	4,0	50,8	39,7
CA20COM-E32-**-P-B-***	53,4	M5	47,8	33,8	24,05	4,0	57,0	44,5
CA20COM-E36-**-P-B-***	59,6	M5	52,6	33,8	24,05	4,0	63,5	49,2

### CA20COM-E with threaded coupling

CA20COM-E is a box mounting receptacle for rear panel mounting. It mates with plugs CA06COM and CA08COM

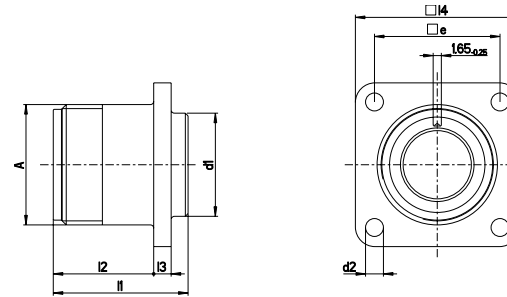

Part No. (pin insert*)	A Thread	d1 max	d2 H13	Code: BM29	l1 max.	l2	l3	l4	e
CA20COM-E10SL-**-P-***	5/8-24UNEF-2A	14,5	3,2	M4	25,1	18,20	2,8	25,4	18,2
CA20COM-E12S-**-P-***	3/4-20UNEF-2A	16,1	3,2	M4	25,1	18,20	3,2	28,0	20,6
CA20COM-E14S-**-P-***	7/8-20UNEF-2A	19,2	3,2	M4	25,1	18,20	3,2	30,0	23,0
CA20COM-E16S-**-P-***	1-20UNEF-2A	22,4	3,2	M4	25,1	18,20	3,2	32,5	24,6
CA20COM-E16-**-P-***	1-20UNEF-2A	22,4	3,2	M4	34,2	21,50	3,2	32,5	24,6
CA20COM-E18-**-P-***	1-1/8-18UNEF-2A	25,6	3,2	M4	34,2	23,05	4,0	35,0	27,0
CA20COM-E20-**-P-***	1-1/4-18UNEF-2A	29,0	3,2	M4	34,2	23,05	4,0	38,0	29,4
CA20COM-E22-**-P-***	1-3/8-18UNEF-2A	32,2	3,2	M4	34,2	23,05	4,0	41,0	31,8
CA20COM-E24-**-P-***	1-1/2-18UNEF-2A	35,3	3,7	M5	34,2	24,05	4,0	44,5	34,9
CA20COM-E28-**-P-***	1-3/4-18UNEF-2A	41,4	3,7	M5	34,2	24,05	4,0	50,8	39,7
CA20COM-E32-**-P-***	2-18UNS-2A	47,8	4,4	M6	34,2	24,05	4,0	57,0	44,5
CA20COM-E36-**-P-***	2-1/4-16UN-2A	54,1	4,4	M6	34,2	24,05	4,0	63,5	49,2

\*For socket inserts substitute "S" for "P" \*\*Add contact arrangement number; see pages 11–15 \*\*\* Add modification code; see page 10 (bottom)

## BOX MOUNTING RECEPTACLE CLASS L, WITH PCB TERMINATION

### CA02COM-L-B with bayonet coupling

CA02COM-L-B is a box mounting receptacle for front panel mounting with pcb termination. It mates with plugs CA06COM-B and CA08COM-B

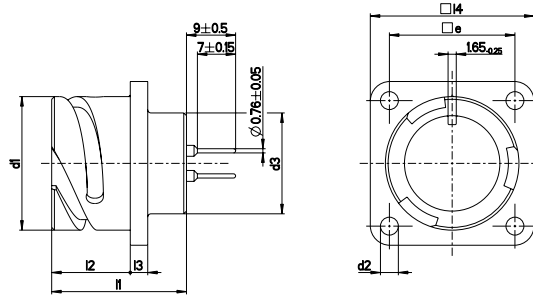

Part No. (pin insert*)	d1	d2	d3	l1	l2	l3	l4	e
	-0,15	H13	max.	± 0,3	+ 0,4	± 0,2	± 0,3	± 0,1
CA02COM-L10SL-**-P-B-***	18,2	3,1	16,2	24,7	14,2	2,8	25,4	18,2
CA02COM-L12S-**-P-B-***	21,4	3,1	16,2	24,7	14,2	3,2	28,0	20,6
CA02COM-L14S-**-P-B-***	24,6	3,1	19,2	24,7	14,2	3,2	30,0	23,0
CA02COM-L16S-**-P-B-***	27,4	3,1	22,4	24,7	14,2	3,2	32,5	24,6
CA02COM-L16-**-P-B-***	27,4	3,1	22,4	33,8	19,0	3,2	32,5	24,6
CA02COM-L18-**-P-B-***	30,8	3,1	25,6	33,8	19,0	4,0	35,0	27,0
CA02COM-L20-**-P-B-***	34,2	3,1	29,0	33,8	19,0	4,0	38,0	29,4
CA02COM-L22-**-P-B-***	37,4	3,1	32,2	33,8	19,0	4,0	41,0	31,8
CA02COM-L24-**-P-B-***	40,9	3,7	35,3	33,8	20,6	4,0	44,5	34,9
CA02COM-L28-**-P-B-***	46,7	3,7	41,4	33,8	20,6	4,0	50,8	39,7
CA02COM-L32-**-P-B-***	53,4	4,4	47,8	33,8	22,2	4,0	57,0	44,5
CA02COM-L36-**-P-B-***	59,6	4,4	52,6	33,8	22,2	4,0	63,5	49,2

### CA02COM-L with threaded coupling

CA02COM-L is a box mounting receptacle for front panel mounting with pcb termination. It mates with plugs CA06COM and CA08COM

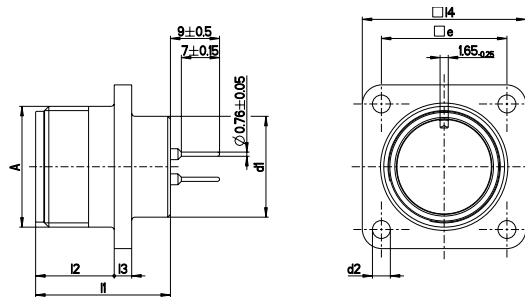
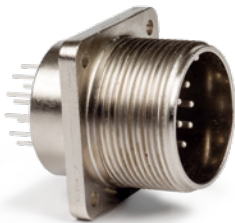

Part No. (pin insert*)	A	d1	d2	l1	l2	l3	l4	e
	Thread	max	H13	max	+ 0,4	± 0,3	± 0,3	± 0,1
CA02COM-L10SL-**-P-***	5/8-24UNEF-2A	15,9	3,1	25,1	14,2	2,8	25,4	18,2
CA02COM-L12S-**-P-***	3/4-20UNEF-2A	15,9	3,1	25,1	14,2	3,2	28,0	20,6
CA02COM-L14S-**-P-***	7/8-20UNEF-2A	19,0	3,1	25,1	14,2	3,2	30,0	23,0
CA02COM-L16S-**-P-***	1-20UNEF-2A	22,2	3,1	25,1	14,2	3,2	32,5	24,6
CA02COM-L16-**-P-***	1-20UNEF-2A	22,2	3,1	34,2	19,0	3,2	32,5	24,6
CA02COM-L18-**-P-***	1-1/8-18UNEF-2A	25,4	3,1	34,2	19,0	4,0	35,0	27,0
CA02COM-L20-**-P-***	1-1/4-18UNEF-2A	29,0	3,1	34,2	19,0	4,0	38,0	29,4
CA02COM-L22-**-P-***	1-3/8-18UNEF-2A	32,2	3,1	34,2	19,0	4,0	41,0	31,8
CA02COM-L24-**-P-***	1-1/2-18UNEF-2A	35,3	3,7	34,2	20,6	4,0	44,5	34,9
CA02COM-L28-**-P-***	1-3/4-18UNEF-2A	41,2	3,7	34,2	20,6	4,0	50,8	39,7
CA02COM-L32-**-P-***	2-18UNS-2A	47,6	4,4	34,2	22,2	4,0	57,0	44,5
CA02COM-L36-**-P-***	2-1/4-16UN-2A	52,4	4,4	34,2	22,2	4,0	63,5	49,2

\*For socket inserts substitute "S" for "P" \*\*Add contact arrangement number; see pages 11–15 \*\*\* Add modification code; see page 10 (bottom)



## BOX MOUNTING RECEPTACLE CLASS L, WITH PCB TERMINATION

### CA20COM-L-B with bayonet coupling

CA20COM-L-B is a box mounting receptacle for rear panel mounting with pcb termination. It mates with plugs CA06COM-B and CA08COM-B

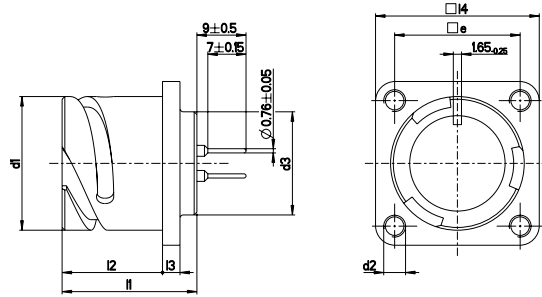

Part No. (pin insert*)	d1	d2	d3	l1	l2	l3	l4	e
	-0,15		max	± 0,3	+ 0,4	± 0,2	± 0,3	± 0,1
CA20COM-L10SL**-P-B-***	18,2	M4	16,2	24,7	18,20	2,8	25,4	18,2
CA20COM-L12S**-P-B-***	21,4	M4	16,2	24,7	18,20	3,2	28,0	20,6
CA20COM-L14S**-P-B-***	24,6	M4	19,2	24,7	18,20	3,2	30,0	23,0
CA20COM-L16S**-P-B-***	27,4	M4	22,4	24,7	18,20	3,2	32,5	24,6
CA20COM-L16**-P-B-***	27,4	M4	22,4	33,8	23,05	3,2	32,5	24,6
CA20COM-L18**-P-B-***	30,8	M4	25,6	33,8	23,05	4,0	35,0	27,0
CA20COM-L20**-P-B-***	34,2	M4	29,0	33,8	23,05	4,0	38,0	29,4
CA20COM-L22**-P-B-***	37,4	M4	32,2	33,8	23,05	4,0	41,0	31,8
CA20COM-L24**-P-B-***	40,9	M4	35,3	33,8	23,05	4,0	44,5	34,9
CA20COM-L28**-P-B-***	46,7	M5	41,4	33,8	24,05	4,0	50,8	39,7
CA20COM-L32**-P-B-***	53,4	M5	47,8	33,8	24,05	4,0	57,0	44,5
CA20COM-L36**-P-B-***	59,6	M5	54,1	33,8	24,05	4,0	63,5	49,2

### CA20COM-L with threaded coupling

CA20COM-L is a box mounting receptacle for rear panel mounting with pcb termination. It mates with plugs CA06COM and CA08COM

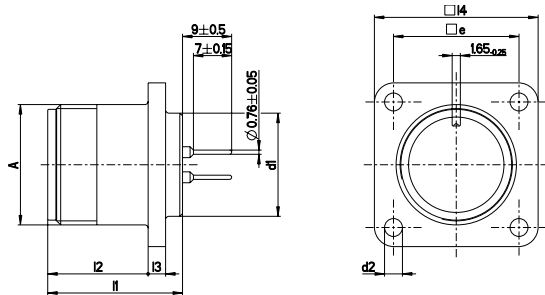

Part No. (pin insert*)	A	d1	d2	l1	l2	l3	l4	e
	Thread	max	H13 Std	max	+ 0,4	± 0,3	± 0,3	± 0,1
				BM29				
CA20COM-L10SL**-P-***	5/8-24UNEF-2A	14,5	3,2	M4	25,1	18,20	2,8	25,4
CA20COM-L12S**-P-***	3/4-20UNEF-2A	16,1	3,2	M4	25,1	18,20	3,2	28,0
CA20COM-L14S**-P-***	7/8-20UNEF-2A	19,2	3,2	M4	25,1	18,20	3,2	30,0
CA20COM-L16S**-P-***	1-20UNEF-2A	22,4	3,2	M4	25,1	18,20	3,2	32,5
CA20COM-L16**-P-***	1-20UNEF-2A	22,4	3,2	M4	34,2	21,50	3,2	32,5
CA20COM-L18**-P-***	1-1/8-18UNEF-2A	25,6	3,2	M4	34,2	23,05	4,0	35,0
CA20COM-L20**-P-***	1-1/4-18UNEF-2A	29,0	3,2	M4	34,2	23,05	4,0	38,0
CA20COM-L22**-P-***	1-3/8-18UNEF-2A	32,2	3,2	M4	34,2	23,05	4,0	41,0
CA20COM-L24**-P-***	1-1/2-18UNEF-2A	35,3	3,7	M5	34,2	24,05	4,0	44,5
CA20COM-L28**-P-***	1-3/4-18UNEF-2A	41,4	3,7	M5	34,2	24,05	4,0	50,8
CA20COM-L32**-P-***	2-18UNS-2A	47,8	4,4	M6	34,2	24,05	4,0	57,0
CA20COM-L36**-P-***	2-1/4-16UN-2A	54,1	4,4	M6	34,2	24,05	4,0	63,5

\*For socket inserts substitute "S" for "P" \*\*Add contact arrangement number; see pages 11-15 \*\*\* Add modification code; see page 10 (bottom)

## STRAIGHT PLUG PG OR METRIC ADAPTER

### CA06COM-PG/ME-B with bayonet coupling

CA06COM-PG/ME-B is a straight plug for usage of PG and metric terminations. It mates with receptacles CA00COM-B, CA01COM-B, CA02COM-E-B and CA20COM-E-B

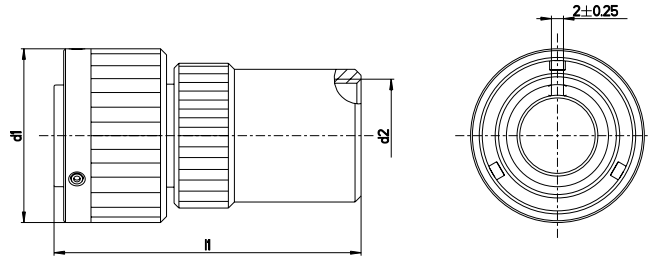

Part No. (pin insert*)		d1 max	d2		l1 max
			PG-Thread	Metric	
CA06COM-PG10SL**P-B-***	CA06COM-ME10SL*P-B-***	22,8	PG9	M16 × 1,5	52,0
CA06COM-PG12S**P-B-***	CA06COM-ME12S**P-B-***	26,0	PG9	M16 × 1,5	52,0
CA06COM-PG14S**P-B-***	CA06COM-ME14S**P-B-***	29,2	PG11	M20 × 1,5	52,0
CA06COM-PG16S**P-B-***	CA06COM-ME16S*P-B-***	32,0	PG13,5	M20 × 1,5	54,0
CA06COM-PG16**P-B-***	CA06COM-ME16**P-B-***	32,0	PG13,5	M20 × 1,5	64,0
CA06COM-PG18**P-B-***	CA06COM-ME18**P-B-***	36,5	PG13,5	M25 × 1,5	69,0
CA06COM-PG20**P-B-***	CA06COM-ME20**P-B-***	39,9	PG16	M25 × 1,5	70,0
CA06COM-PG22**P-B-***	CA06COM-ME22**P-B-***	42,1	PG16	M32 × 1,5	73,0
CA06COM-PG24**P-B-***	CA06COM-ME24**P-B-***	46,6	PG16	M32 × 1,5	74,0
CA06COM-PG28**P-B-***	CA06COM-ME28**P-B-***	53,4	PG21	M32 × 1,5	74,0
CA06COM-PG32**P-B-***	CA06COM-ME32**P-B-***	60,1	PG29	M40 × 1,5	76,0
CA06COM-PG36**P-B-***	CA06COM-ME36**P-B-***	66,3	PG29	M40 × 1,5	87,0

### CA06COM-PG/ME with threaded coupling

CA06COM-PG/ME is a straight plug for usage of PG and metric terminations. It mates with receptacles CA00COM, CA01COM, CA02COM-E and CA20COM-E

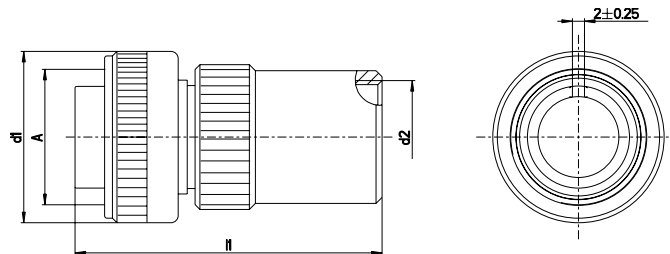

Part No. (pin insert*)		A Thread	d1 max	d2		l1 max
				PG-Thread	Metric	
CA06COM-PG10SL**P-***	CA06COM-ME10SL*P-***	5/8-24UNEF-2B	24,1	PG9	M16 × 1,5	52,0
CA06COM-PG12S**P-***	CA06COM-ME12S**P-***	3/4-20UNEF-2B	25,8	PG9	M16 × 1,5	52,0
CA06COM-PG14S**P-***	CA06COM-ME14S**P-***	7/8-20UNEF-2B	28,8	PG11	M20 × 1,5	52,0
CA06COM-PG16S**P-***	CA06COM-ME16S*P-***	1-20UNEF-2B	31,8	PG13,5	M20 × 1,5	54,0
CA06COM-PG16**P-***	CA06COM-ME16**P-***	1-20UNEF-2B	31,8	PG13,5	M20 × 1,5	64,0
CA06COM-PG18**P-***	CA06COM-ME18**P-***	1-1/8-18UNEF-2B	34,1	PG13,5	M25 × 1,5	69,0
CA06COM-PG20**P-***	CA06COM-ME20**P-***	1-1/4-18UNEF-2B	37,4	PG16	M25 × 1,5	70,0
CA06COM-PG22**P-***	CA06COM-ME22**P-***	1-3/8-18UNEF-2B	40,5	PG16	M32 × 1,5	73,0
CA06COM-PG24**P-***	CA06COM-ME24**P-***	1-1/2-18UNEF-2B	43,8	PG16	M32 × 1,5	74,0
CA06COM-PG28**P-***	CA06COM-ME28**P-***	1-3/4-18UNEF-2B	50,2	PG21	M32 × 1,5	74,0
CA06COM-PG32**P-***	CA06COM-ME32**P-***	2-18UNS-2B	56,4	PG29	M40 × 1,5	76,0
CA06COM-PG36**P-***	CA06COM-ME36**P-***	2-1/4-16UN-2B	62,8	PG29	M40 × 1,5	87,0

\* For socket inserts substitute "S" for "P" \*\* Add contact arrangement number; see pages 11–15 \*\*\* Add modification code; see page 10 (bottom)

## STRAIGHT PLUG CLASS E

### CA06COM-E-B with bayonet coupling

CA06COM-E-B is a straight plug with endbell and cable clamp. It mates with receptacles CA00COM-B CA01COM-B, CA02COM-E-B and CA20COM-E-B

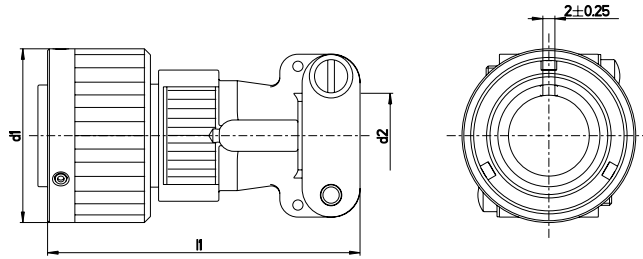

Part No. (pin insert*)	d1 max.	d2 <sup>1)</sup> max.	l1
CA06COM-E10SL-**P-B-***	22,8	7,9	53
CA06COM-E12S-**P-B-***	26,0	7,9	53
CA06COM-E14S-**P-B-***	29,2	11,1	55
CA06COM-E16S-**P-B-***	32,0	14,2	56
CA06COM-E16-**P-B-***	32,0	14,2	66
CA06COM-E18-**P-B-***	36,5	15,8	68
CA06COM-E20-**P-B-***	39,9	19,0	68
CA06COM-E22-**P-B-***	43,1	19,0	68
CA06COM-E24-**P-B-***	46,6	23,7	76
CA06COM-E28-**P-B-***	53,4	23,7	76
CA06COM-E32-**P-B-***	60,1	31,8	76
CA06COM-E36-**P-B-***	66,3	34,6	76

### CA06COM-E with threaded coupling

CA06COM-E is a straight plug with endbell and cable clamp. It mates with receptacles CA00COM, CA01COM, CA02COM-E and CA20COM-E

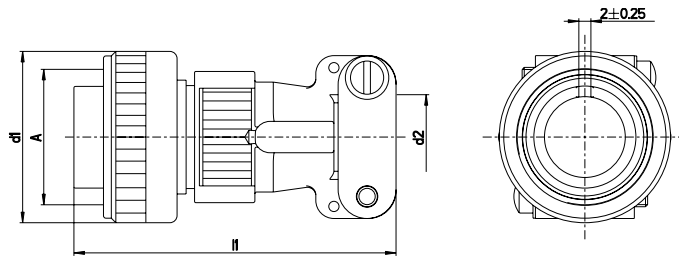

Part No. (pin insert*)	A Thread	d1 max	d2 <sup>1)</sup> max.	l1 max.
CA06COM-E10SL-**P-***	5/8-24UNEF-2B	24,1	7,9	53
CA06COM-E12S-**P-***	3/4-20UNEF-2B	25,8	7,9	53
CA06COM-E14S-**P-***	7/8-20UNEF-2B	28,8	11,1	55
CA06COM-E16S-**P-***	1-20UNEF-2B	31,8	14,2	56
CA06COM-E16-**P-***	1-20UNEF-2B	31,8	14,2	66
CA06COM-E18-**P-***	1-1/8-18UNEF-2B	34,1	15,8	68
CA06COM-E20-**P-***	1-1/4-18UNEF-2B	37,4	19,0	68
CA06COM-E22-**P-***	1-3/8-18UNEF-2B	40,5	19,0	68
CA06COM-E24-**P-***	1-1/2-18UNEF-2B	43,8	23,7	76
CA06COM-E28-**P-***	1-3/4-18UNS-2B	50,2	23,7	76
CA06COM-E32-**P-***	2-18UNS-2B	56,4	31,8	76
CA06COM-E36-**P-***	2-1/4-16UN-2B	62,8	34,6	76

\*For socket inserts substitute "S" for "P" \*\*Add contact arrangement number; see pages 11–15 \*\*\* Add modification code; see page 10 (bottom) <sup>1)</sup>max cable dia

## STRAIGHT PLUG CLASS F

### CA06COM-F-B with bayonet coupling

CA06COM-F-B is a straight plug with endbell for flex tubes. It mates with receptacles CA00COM-B, CA01COM-B, CA02COM-E-B and CA20COM-E-B

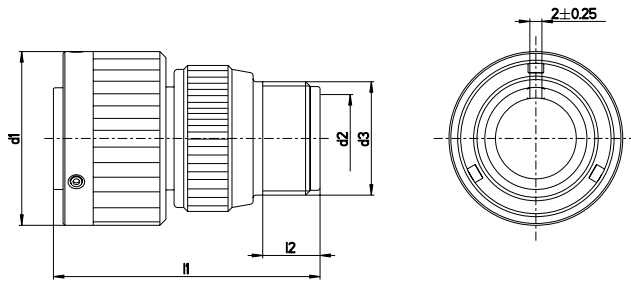

Part No. (pin insert*)	d1	d2 <sup>1)</sup>	l2	l1
	max	max	min	max
CA06COM-F10SL-**P-B-***	22,8	8,2	9,5	45
CA06COM-F12S-**P-B-***	26,0	8,2	9,5	45
CA06COM-F14S-**P-B-***	29,2	11,1	9,5	45
CA06COM-F16S-**P-B-***	32,0	14,3	9,5	45
CA06COM-F16-**P-B-***	32,0	14,3	9,5	54
CA06COM-F18-**P-B-***	36,5	16,7	9,5	54
CA06COM-F20-**P-B-***	39,9	19,8	9,5	55
CA06COM-F22-**P-B-***	43,1	19,8	9,5	58
CA06COM-F24-**P-B-***	46,6	25,4	9,5	59
CA06COM-F28-**P-B-***	53,4	27,0	9,5	59
CA06COM-F32-**P-B-***	60,1	32,5	11,0	62
CA06COM-F36-**P-B-***	66,3	35,7	11,8	64

### CA06COM-F with threaded coupling

CA06COM-F is a straight plug with endbell for flex tubes. It mates with receptacles CA00COM, CA01COM, CA02COM-E and CA20COM-E

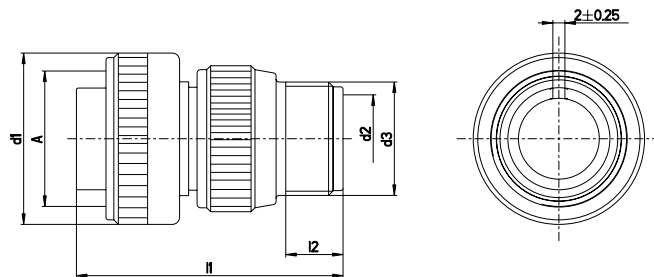

Part No. (pin insert*)	A	d1	d2 <sup>1)</sup>	d3	l1	l2
	Thread	max		Thread	max	min
CA06COM-F10SL-**P-***	5/8-24UNEF-2B	24,1	8,2	5/8-24UNEF-2A	45	9,5
CA06COM-F12S-**P-***	3/4-20UNEF-2B	25,8	8,2	5/8-20UNEF-2A	45	9,5
CA06COM-F14S-**P-***	7/8-20UNEF-2B	28,8	11,1	3/4-20UNEF-2A	45	9,5
CA06COM-F16S-**P-***	1-20UNEF-2B	31,8	14,3	7/8-20UNEF-2A	45	9,5
CA06COM-F16-**P-***	1-20UNEF-2B	31,8	14,3	7/8-20UNEF-2A	54	9,5
CA06COM-F18-**P-***	1-1/8-18UNEF-2B	34,1	16,7	1-20UNEF-2A	54	9,5
CA06COM-F20-**P-***	1-1/4-18UNEF-2B	37,4	19,8	1-3/16-18UNEF-2A	55	9,5
CA06COM-F22-**P-***	1-3/8-18UNEF-2B	40,5	19,8	1-3/16-18UNEF-2A	58	9,5
CA06COM-F24-**P-***	1-1/2-18UNEF-2B	43,8	25,4	1-7/16-18UNEF-2A	59	9,5
CA06COM-F28-**P-***	1-3/4-18UNEF-2B	50,2	27,0	1-7/16-18UNEF-2A	60	9,5
CA06COM-F32-**P-***	2-18UNS-2B	56,4	32,5	1-3/4-18UNS-2A	62	11,0
CA06COM-F36-**P-***	2-1/4-16UN-2B	62,8	35,7	2-18UNS-2A	64	11,8

\* For socket inserts substitute "S" for "P" \*\* Add contact arrangement number; see pages 11–15 \*\*\* Add modification code; see page 10 (bottom) <sup>1)</sup> max cable dia

## STRAIGHT PLUG CLASS E

### CA06COM-E-B/-03/-06 with bayonet coupling

CA06COM-E-B/-03/-06 is a straight plug with endbell (wire sealing) for heat shrink boots. It mates with receptacles CA00COM-B, CA01COM-B, CA02COM-E-B and CA20COM-E-B

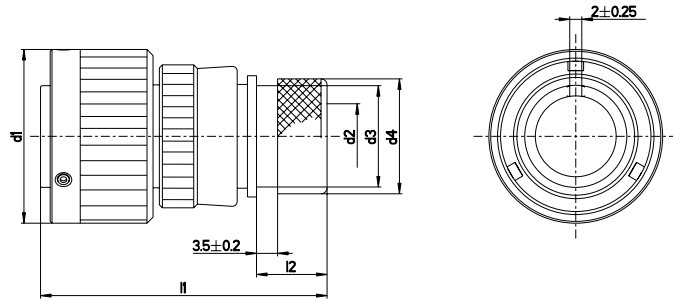

Part No. (pin insert*)	d1	d2 <sup>1)</sup>	d3	d4	l1	l2
	max		max	± 0,2	max	± 0,5
CA06COM-E10SL-**P-B-***	22,8	7,7	13,3	15,5	49	11,7
CA06COM-E12S-**P-B-***	26,0	7,9	13,3	15,5	49	11,7
CA06COM-E14S-**P-B-***	29,2	10,6	17,0	19,1	49	11,7
CA06COM-E16S-**P-B-***	32,0	13,5	21,9	23,9	49	11,7
CA06COM-E16-**P-B-***	32,0	13,5	21,9	23,9	58	11,5
CA06COM-E18-**P-B-***	36,5	14,6	21,9	23,9	58	11,5
CA06COM-E20-**P-B-***	39,9	18,7	26,2	29,6	60	12,7
CA06COM-E22-**P-B-***	43,1	20,8	26,2	29,6	60	12,7
CA06COM-E24-**P-B-***	46,6	24,6	34,5	37,8	63	12,7
CA06COM-E28-**P-B-***	53,4	27,0	34,5	37,8	63	12,7
CA06COM-E32-**P-B-***	60,1	33,3	43,6	47,8	67	15,2
CA06COM-E36-**P-B-***	66,3	38,5	43,6	47,8	68	15,2

### CA06COM-E-DN with threaded coupling

CA06COM-E-DN is a straight plug with endbell (wire sealing) for heat shrink boots. It mates with receptacles CA00COM, CA01COM and CA02COM-E and CA20COM-E

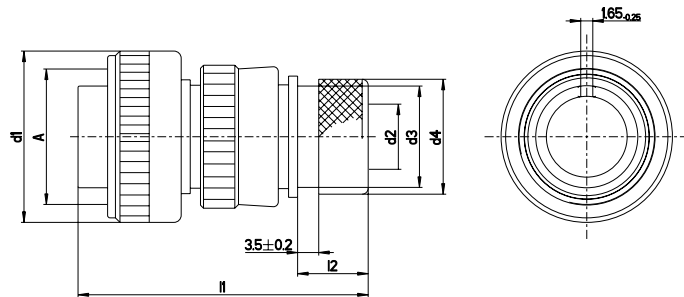

Part No. (pin insert*)	A	d1	d2 <sup>1)</sup>	d3	d4	l1	l2
	Thread	max	max	max	± 0,2	max	± 0,5
CA06COM-E10SL-**P-DN	5/8-24UNEF-2B	24,1	7,7	13,3	15,5	49	11,7
CA06COM-E12S-**P-DN	3/4-20UNEF-2B	25,8	7,9	13,3	15,5	49	11,7
CA06COM-E14S-**P-DN	7/8-20UNEF-2B	28,8	10,6	17,0	19,1	49	11,7
CA06COM-E16S-**P-DN	1-20UNEF-2B	31,8	13,5	21,9	23,9	49	11,7
CA06COM-E16-**P-DN	1-20UNEF-2B	31,8	13,5	21,9	23,9	58	11,5
CA06COM-E18-**P-DN	1-1/8-18UNEF-2B	34,1	14,6	21,9	23,9	58	11,5
CA06COM-E20-**P-DN	1-1/4-18UNEF-2B	37,4	18,7	26,2	29,6	60	12,7
CA06COM-E22-**P-DN	1-3/8-18UNEF-2B	40,5	20,8	26,2	29,6	60	12,7
CA06COM-E24-**P-DN	1-1/2-18UNEF-2B	43,8	24,6	34,5	37,8	63	12,7
CA06COM-E28-**P-DN	1-3/4-18UNEF-2B	50,2	27,0	34,5	37,8	63	12,7
CA06COM-E32-**P-DN	2-18UNS-2B	56,4	33,3	43,6	47,8	67	15,2
CA06COM-E36-**P-DN	2-1/4-16UN-2B	62,8	38,5	43,6	47,8	68	15,2

\*For socket inserts substitute "S" for "P" \*\*Add contact arrangement number; see pages 11–15 \*\*\* -03: with metric crimp contacts, -06: with solder pot contacts <sup>1)</sup>max cable dia

## 90° PLUG CLASS E

### CA08COM-E-B with bayonet coupling

CA08COM-E-B is a 90° plug with cable clamp. It mates with receptacles CA00COM-B, CA01COM-B, CA02COM-E-B and CA20COM-E-B

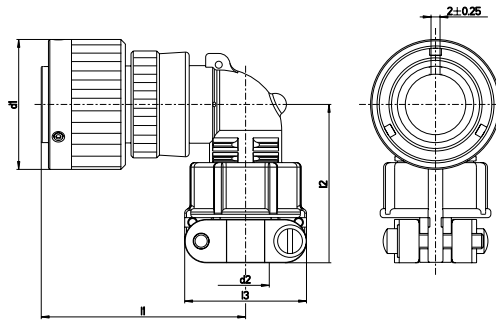

Part No. (pin insert*)	d1	d2 <sup>1)</sup>	l1	l2	l3
	max		max	max	max
CA08COM-E10SL-**P-B-***	22,8	7,9	45	42	22,7
CA08COM-E12S-**P-B-***	26,0	7,9	45	42	22,7
CA08COM-E14S-**P-B-***	29,2	11,1	47	42	27,5
CA08COM-E16S-**P-B-***	32,0	14,2	48	45	30,0
CA08COM-E16-**P-B-***	32,0	14,2	48	45	30,0
CA08COM-E18-**P-B-***	36,5	15,8	58	53	33,0
CA08COM-E20-**P-B-***	39,9	19,0	61	53	37,5
CA08COM-E22-**P-B-***	43,1	19,0	61	53	37,5
CA08COM-E24-**P-B-***	46,6	23,7	66	58	43,3
CA08COM-E28-**P-B-***	53,4	23,7	66	58	43,3
CA08COM-E32-**P-B-***	60,1	31,8	72	66	51,7
CA08COM-E36-**P-B-***	66,3	34,6	75	69	58,0

### CA08COM-E with threaded coupling

CA08COM-E is a 90° plug with cable clamp. It mates with receptacles CA00COM, CA01COM, CA02COM-E and CA20COM-E

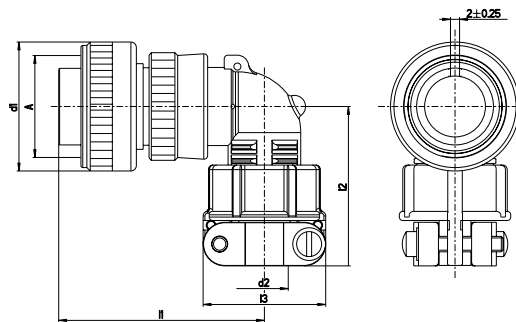

Part No. (pin insert*)	A	d1	d2 <sup>1)</sup>	l1	l2	l3
	Thread	max		max	max	max
CA08COM-E10SL-**P-***	5/8-24UNEF-2B	24,1	7,9	45	42	22,7
CA08COM-E12S-**P-***	3/4-20UNEF-2B	25,8	7,9	45	42	22,7
CA08COM-E14S-**P-***	7/8-20UNEF-2B	28,8	11,1	47	42	27,5
CA08COM-E16S-**P-***	1-20UNEF-2B	31,8	14,2	48	45	30,0
CA08COM-E16-**P-***	1-20UNEF-2B	31,8	14,2	48	45	30,0
CA08COM-E18-**P-***	1-1/8-18UNEF-2B	34,1	15,8	58	53	33,0
CA08COM-E20-**P-***	1-1/4-18UNEF-2B	37,4	19,0	61	53	37,5
CA08COM-E22-**P-***	1-3/8-18UNEF-2B	40,5	19,0	61	53	37,5
CA08COM-E24-**P-***	1-1/2-18UNEF-2B	43,8	23,7	66	58	43,3
CA08COM-E28-**P-***	1-3/4-18UNEF-2B	50,2	23,7	66	58	43,3
CA08COM-E32-**P-***	2-18UNS-2B	56,4	31,8	72	66	51,7
CA08COM-E36-**P-***	2-1/4-16UN-2B	62,8	34,6	75	69	58,0

\*For socket inserts substitute "S" for "P" \*\*Add contact arrangement number; see pages 11–15 \*\*\* Add modification code; see page 10 (bottom) <sup>1)</sup>max cable dia



## 90° PLUG CLASS F

### CA08COM-F-B with bayonet coupling

CA08COM-F-B is a 90° plug for flex tubes. It mates with receptacles CA00COM-B, CA01COM-B, CA02COM-E-B and CA20COM-E-B

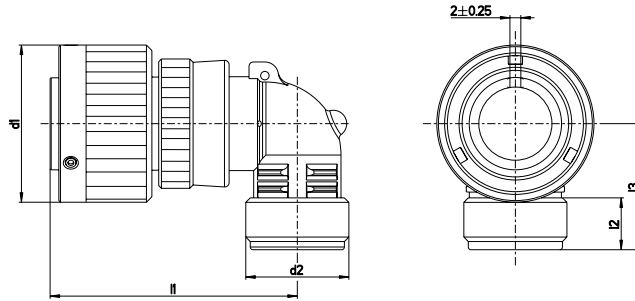

Part No. (pin insert*)	d1 max	d2 Thread	l1 max	l2 min	l3 max
CA08COM-F10SL-**P-B-***	22,8	5/8-24UNEF-2B	45	9,4	22,0
CA08COM-F12S-**P-B-***	26,0	5/8-20UNEF-2B	45	9,4	22,0
CA08COM-F14S-**P-B-***	29,2	3/4-20UNEF-2B	47	9,4	24,0
CA08COM-F16S-**P-B-***	32,0	7/8-20UNEF-2B	48	9,4	25,0
CA08COM-F16-**P-B-***	32,0	7/8-20UNEF-2B	57	9,4	25,0
CA08COM-F18-**P-B-***	36,5	1-20UNEF-2B	58	9,4	27,0
CA08COM-F20-**P-B-***	39,9	1-3/16-18UNEF-2B	61	9,4	29,0
CA08COM-F22-**P-B-***	43,1	1-3/16-18UNEF-2B	61	9,4	30,0
CA08COM-F24-**P-B-***	46,6	1-7/16-18UNEF-2B	66	9,4	32,0
CA08COM-F28-**P-B-***	53,4	1-7/16-18UNEF-2B	66	9,4	34,0
CA08COM-F32-**P-B-***	60,1	1-3/4-18UNS-2B	72	11,0	39,5
CA08COM-F36-**P-B-***	66,3	2-18UNS-2B	75	12,6	45,0

### CA08COM-F with threaded coupling

CA08COM-F is a 90° plug for flex tubes. It mates with receptacles CA00COM, CA01COM, CA02COM-E and CA20COM-E

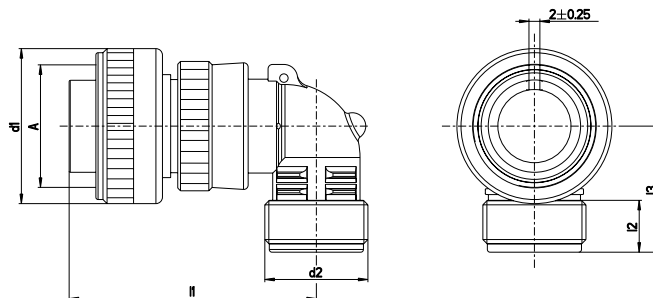

Part No. (pin insert*)	A Thread	d1 max	d2 Thread	l1 max	l2 min	l3 max
CA08COM-F10SL-**P-***	5/8-24UNEF-2B	24,1	5/8-24UNEF-2A	45	9,4	22,0
CA08COM-F12S-**P-***	3/4-20UNEF-2B	25,8	5/8-20UNEF-2A	45	9,4	22,0
CA08COM-F14S-**P-***	7/8-20UNEF-2B	28,8	3/4-20UNEF-2A	47	9,4	24,0
CA08COM-F16S-**P-***	1-20UNEF-2B	31,8	7/8-20UNEF-2A	48	9,4	25,0
CA08COM-F16-**P-***	1-20UNEF-2B	31,8	7/8-20UNEF-2A	48	9,4	25,0
CA08COM-F18-**P-***	1-1/8-18UNEF-2B	34,1	1-20UNEF-2A	58	9,4	27,0
CA08COM-F20-**P-***	1-1/4-18UNEF-2B	37,4	1-3/16-18UNEF-2A	61	9,4	29,0
CA08COM-F22-**P-***	1-3/8-18UNEF-2B	40,5	1-3/16-18UNEF-2A	61	9,4	30,0
CA08COM-F24-**P-***	1-1/2-18UNEF-2B	43,8	1-7/16-18UNEF-2A	66	9,4	32,0
CA08COM-F28-**P-***	1-3/4-18UNEF-2B	50,2	1-7/16-18UNEF-2A	66	9,4	34,0
CA08COM-F32-**P-***	2-18UNS-2B	56,4	1-3/4-18UNS-2A	72	11,0	39,5
CA08COM-F36-**P-***	2-1/4-16UN-2B	62,8	2-18UNS-2A	75	12,6	45,0

\*For socket inserts substitute "S" for "P" \*\*Add contact arrangement number; see pages 11–15 \*\*\* Add modification code; see page 10 (bottom)

## 90° PLUG CLASS PG (METRIC THREAD OPTION UNAVAILABLE)

### CA08COM-PG-B with bayonet coupling

CA08COM-PG-B designates a 90° plug for usage of PG terminations. It mates with receptacles CA00COM-B, CA01COM-B, CA02COM-E-B and CA20COM-E-B

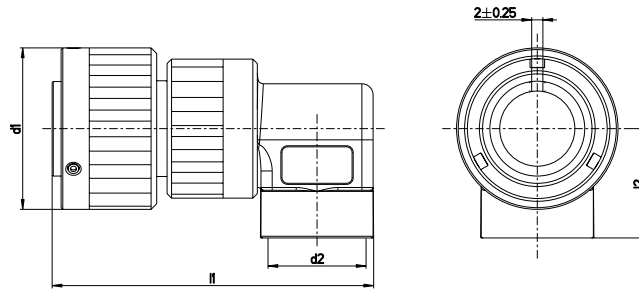

Part No. (pin insert*)	d1 max.	d2	l1 max	l2 ± 0,5
CA08COM-E10SL-**P-B-***	22.8	PG9	57	18.5
CA08COM-E12S-**P-B-***	26.0	PG9	57	18.5
CA08COM-E14S-**P-B-***	29.2	PG11	59	19.5
CA08COM-E16S-**P-B-***	32.0	PG13,5	63	22.0
CA08COM-E16-**P-B-***	32.0	PG13,5	72	22.0
CA08COM-E18-**P-B-***	36.5	PG16	77	26.3
CA08COM-E20-**P-B-***	39.9	PG21	82	29.0
CA08COM-E22-**P-B-***	43.1	PG21	82	29.5

### CA08COM-PG with threaded coupling

CA08COM-PG designates a 90° plug for usage of PG terminations. It mates with receptacles CA00COM, CA01COM, CA02COM-E and CA20COM

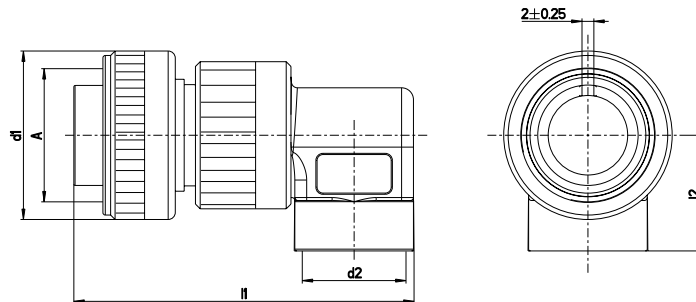
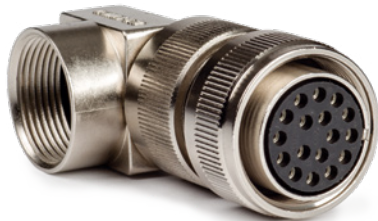

Part No. (pin insert*)	A Thread	d1 max.	d2	l1 max	l2 ± 0,5
CA08COM-E10SL-**P-***	5/8-24UNEF-2B	24.1	PG9	57	18.5
CA08COM-E12S-**P-***	3/4-20UNEF-2B	25.8	PG9	57	18.5
CA08COM-E14S-**P-***	7/8-20UNEF-2B	28.8	PG11	59	19.5
CA08COM-E16S-**P-***	1-20UNEF-2B	31.8	PG13,5	63	22.0
CA08COM-E16-**P-***	1-20UNEF-2B	31.8	PG13,5	72	22.0
CA08COM-E18-**P-***	1-1/8-20UNEF-2B	34.1	PG16	77	26.3
CA08COM-E20-**P-***	1-1/4-20UNEF-2B	37.4	PG21	82	29.0
CA08COM-E22-**P-***	1-3/8-20UNEF-2B	40.5	PG21	82	29.5

\* For socket inserts substitute "S" for "P" \*\* Add contact arrangement number; see pages 11–15 \*\*\* Add modification code; see page 10 (bottom) <sup>1)</sup> max cable dia



## ACCESSORIES

### PROTECTIVE CAPS

with cord for receptacles with bayonet coupling. It mates with receptacles CA00COM-B, CA01COM-E-B and CA02COM-E-B CA20COM-E-B

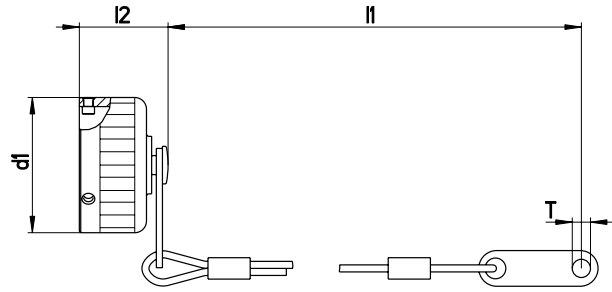

Part No.	Shell size	d1	l1	l2	T
		max	± 10	max	+ 0,25
CA121003-1701	10SL	22.4	100	16	4.3
CA121003-1702	12S	25.6	100	16	4.3
CA121003-1703	14S	28.8	100	16	4.3
CA121003-1704	16S	31.6	100	16	4.3
CA121003-1705	16	31.6	113	16	4.3
CA121003-1706	18	35.7	113	16	4.3
CA121003-1707	20	39.1	127	16	4.3
CA121003-1708	22	42.3	127	16	4.3
CA121003-1709	24	45.8	127	16	4.3
CA121003-1710	28	51.6	169	18	5.5
CA121003-1711	32	58.3	169	18	5.5
CA121003-1712	36	64.5	169	18	5.5

### PROTECTIVE CAPS

with cord for receptacles with threaded coupling. It mates with receptacles CA00COM, CA01COM and CA02COM and CA20COM

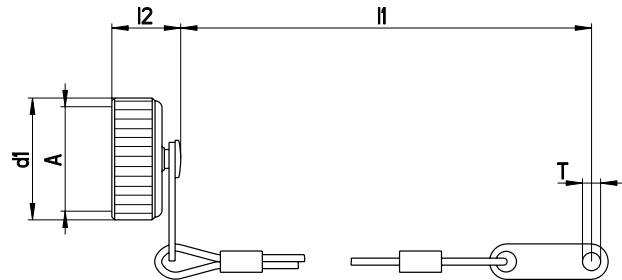

Part No.	Shell size	A	d1	l1	l2	T
		Thread	max	max	max	+ 0,2
CA121003-1601	10 SL	5/8-24UNEF-2B	20.2	100	16,0	3.6
CA121003-1602	12S	3/4-20UNEF-2B	23,4	120	16,0	3.6
CA121003-1603	14S	7/8-20UNEF-2B	26.6	120	16,0	3.6
CA121003-1604	16S,16	1-20UNEF-2B	29.8	120	16,0	3.6
CA121003-1606	18	1-1/8-18UNEF-2B	32.9	120	16,0	3.6
CA121003-1607	20	1-1/4-18UNEF-2B	36.1	125	16,0	3.6
CA121003-1608	22	1-3/8-18UNEF-2B	39.4	125	16,0	3.6
CA121003-1609	24	1-1/2-18UNEF-2B	42.6	140	16,0	4.4
CA121003-1610	28	1-3/4-18UNEF-2B	48.9	200	18,0	4.4
CA121003-1611	32	2-18UNS-2B	55.3	200	18,0	4.8
CA121003-1612	36	2-1/4-16UN-2B	61.6	200	18,0	4.8

## ACCESSORIES

### PROTECTIVE CAPS

with cord for receptacles with bayonet coupling. It mates with receptacles CA06COM-B and CA08COM-B

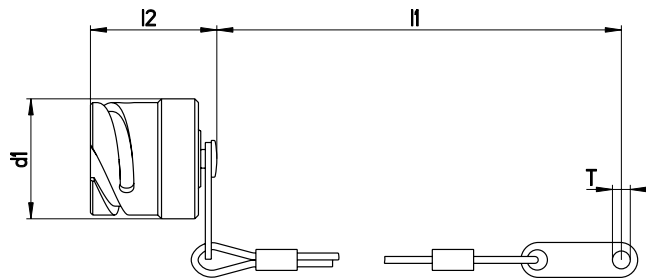

Part No.	Shell size	d1 max	l1 ca	l2 max	T + 0,5
CA121004-1701	10SL	20,7	100	29	4,3
CA121004-1702	12S	23,9	113	29	4,3
CA121004-1703	14S	27,1	113	29	4,3
CA121004-1704	16S	29,9	113	29	4,3
CA121004-1705	16	29,9	127	37	4,3
CA121004-1706	18	33,3	127	37	4,3
CA121004-1707	20	36,7	140	37	4,7
CA121004-1708	22	39,9	140	37	4,7
CA121004-1709	24	43,4	140	37	4,7
CA121004-1710	28	49,2	197	37	4,7
CA121004-1711	32	55,9	197	37	5,5
CA121004-1712	36	62,1	197	37	5,5

### PROTECTIVE CAPS

with cord for receptacles with threaded coupling. It mates with receptacles CA06COM and CA08COM

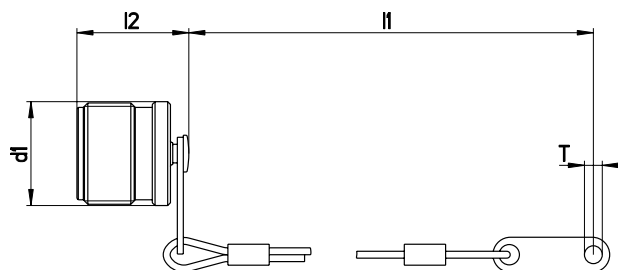

Part No.	Shell size	A Thread	d1 max	l1 ca.	T + 0,4
CA121004-1601	10SL	5/8-24UNEF-2A	16,7	100	4,0
CA121004-1602	12S	3/4-20UNEF-2A	19,8	100	4,0
CA121004-1603	14S	7/8-20UNEF-2A	23,0	115	4,0
CA121004-1604	16S, 16	1-20UNEF-2A	26,2	115	4,0
CA121004-1606	18	1-1/8-18UNEF-2A	29,4	115	4,0
CA121004-1607	20	1-1/4-18UNEF-2A	32,5	125	4,8
CA121004-1608	22	1-3/8-18UNEF-2A	35,7	125	4,8
CA121004-1609	24	1-1/2-18UNEF-2A	38,9	140	4,8
CA121004-1610	28	1-3/4-18UNEF-2A	45,2	200	4,8
CA121004-1611	32	2-18UNS-2A	51,6	200	5,6
CA121004-1612	36	2-1/4-16UN-2A	57,9	200	5,6

## ACCESSORIES

### CABLE CLAMP WITHOUT BUSHING

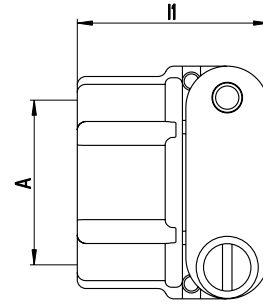
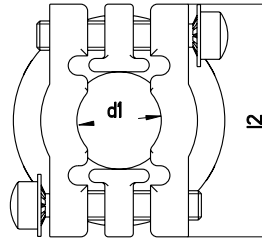

Part No.	Shell size	A Thread	d1 max	l1 max	l2 max
CA121051-325	10SL, 12S	5/8-24UNEF-2B	7,9	20,8	22,5
CA121051-326	14S	3/4-20UNEF-2B	11,1	22,4	27,4
CA121051-327	16S, 16	7/8-20UNEF-2B	14,2	24,0	29,8
CA121051-328	18	1-20UNEF-2B	15,8	24,0	32,2
CA121051-329	20, 22	1-3/16-18UNEF-2B	19,0	24,0	37,4
CA121051-330	24, 28	1-7/16-18UNEF-2B	23,7	26,4	43,5
CA121051-331	32	1-3/4-18UNS-2B	31,8	28,0	51,7
CA121051-332	36	2-18UNS-2B	34,6	29,6	57,8

### TELESCOPING BUSHING

The telescoping bushing is used together with above cable clamps CA121051-... or the other E type cable clamp connectors. It keeps oil, dirt or dust out of the endbell. Taping or wrapping or insulating of the wires feed through the clamp is eliminated since they are protected by the bushing. Combinations of bushings may be used to reduce cable entry diameters for improved sealing.

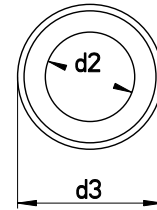

Part No.	Shell size	d1 - 0,3	d2 - 0,3	d3 max	l1 max
012-8552-000	10SL, 12S	8,0	6,6	9,9	70
012-8554-000	14S	10,9	9,1	12,7	67
012-0218-000	16S, 16	14,0	11,1	19,0	64
012-0219-000	18	15,7	14,3	22,0	60
012-0220-000	20, 22	18,8	15,9	26,9	57
012-8555-000	24, 28	21,2	16,6	26,9	57
012-8556-000	24, 28	23,6	21,5	33,3	54
012-8557-000	32	26,5	21,5	33,3	54
012-8558-000	32	31,5	26,8	40,4	51
012-8558-000	36	31,5	26,8	40,4	51
012-0223-000	36	34,7	31,8	46,8	48

## ACCESSORIES

### GASKETS

These sealing gaskets made of neoprene are used with receptacles with flange for sealing between the shell and the flange of the receptacle

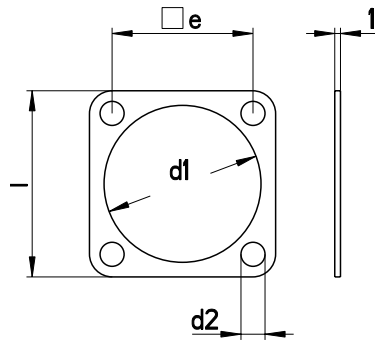

#### Gaskets for CA00COM-B / CA20COM-B (Rear panel mounting bayonet)

Part No.	Shell size	d1 + 0,3	d2 + 0,5	l ± 0,5	e ± 0,2
075-8501-000	10SL	18,2	4,2	25,4	18,2
075-8502-000	12S	21,4	4,2	28,0	20,6
075-8503-000	14S	24,6	4,2	30,0	23,0
075-8504-000	16S, 16	27,4	4,2	32,5	24,6
075-8505-000	18	30,8	4,2	35,0	27,0
075-8506-000	20	34,2	4,2	38,0	29,4
075-8507-000	22	37,4	4,2	41,0	31,8
075-8508-000	24	40,9	4,2	44,5	34,9
075-8509-000	28	46,7	5,1	50,8	39,7
075-8510-000	32	53,4	5,1	57,0	44,5
075-8511-000	36	59,6	5,1	63,5	49,2

#### Gaskets for CA00COM / CA02COM / CA02COM-B

Part No.	Shell size	d1 + 1,0	d2 + 0,5	l ± 0,5	e ± 0,2
075-8512-000	10SL	15,7	4,2	25,4	18,2
075-8513-000	12S	18,9	4,2	28,0	20,6
075-8514-000	14S	22,1	4,2	30,0	23,0
075-8515-000	16S, 16	25,3	4,2	32,5	24,6
075-8516-000	18	28,4	4,2	35,0	27,0
075-8517-000	20	31,6	4,2	38,0	29,4
075-8518-000	22	34,8	4,2	41,0	31,8
075-8519-000	24	38,0	4,2	44,5	34,9
075-8520-000	28	44,3	5,1	50,8	39,7
075-8521-000	32	50,7	5,1	57,0	44,5
075-8522-000	36	57,0	5,1	63,5	49,2

## ACCESSORIES

### CONTACTS

Standard contacts and contacts with reduced termination diameter

SIZE 15S/16S, 15/16, 25/12, 60/100/8, 160/4, 500/0

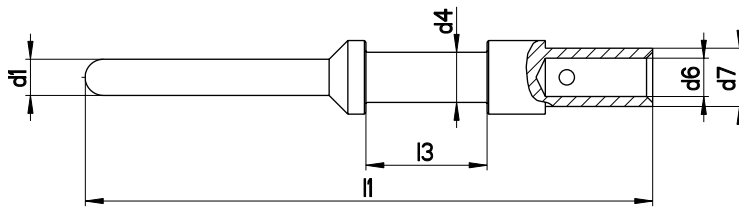

SIZE 10/20

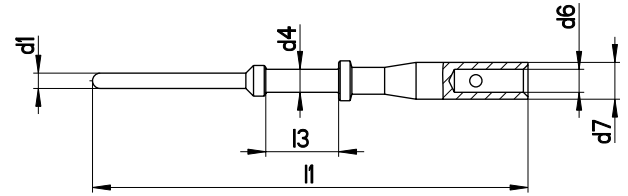

**Pin contacts** Finish: A36–5 $\mu$ m silver plated and passivated

Contact size	Wire size		Part no.	d1 -0,05	d4	d6	d7	l1 $\pm 0,15$	l3 $\pm 0,5$	Color code
	mm <sup>2</sup>	AWG								
10/20	0,5–1,0	20/18	030-8585-000	1,04	1,50	1,50	2,40	28,4	4,75	–
	0,2–0,4	26/22	030-8585-010	1,04	1,50	0,90	2,40	28,4	4,75	blue
15S/16S	0,75–1,5	18/16	030-8586-000	1,60	1,75	1,75	2,75	27,4	3,85	–
	0,3–0,6	22/20	330-8744-000	1,60	1,75	1,20	2,75	27,4	3,85	red
	0,14–0,38	22/26	030-8586-010	1,60	1,75	0,90	2,75	27,4	3,85	blue
15/16	0,75–1,5	18/16	030-8587-000	1,60	1,75	1,75	2,75	31,4	7,90	–
	0,3–0,6	22/20	330-8659-000	1,60	1,75	1,20	2,75	31,4	7,90	red
	0,14–0,38	22/26	030-8587-030	1,60	1,75	0,90	2,75	31,4	7,90	blue
25/12	2,0–3,0	14/12	030-8588-000	2,40	3,30	2,50	3,80	37,0	7,90	–
	0,75–1,5	18/16	030-8588-010	2,40	3,30	1,75	3,40	37,0	7,90	black
	4,0	–	030-8588-054	2,40	3,30	2,80	3,80	37,0	7,90	–
60/100/8	–	8	030-8612-000	3,60	6,25	4,55	6,80	39,6	6,35	–
	6,0	10	030-8589-000	3,60	6,25	3,50	6,80	39,6	6,35	yellow
	10,0	–	030-8590-000	3,60	6,25	4,80	6,80	39,6	6,35	–
	2,0–3,0	14/12	030-8612-010	3,60	6,25	2,50	6,80	39,6	6,35	green
160/4	–	4	030-8613-000	5,75	9,55	7,10	9,55	39,6	6,35	–
	16,0	–	030-8591-000	5,75	9,55	6,20	9,55	39,6	6,35	–
	10,0	–	030-8591-020	5,75	9,55	4,80	9,55	39,6	6,35	–
	–	6	030-8613-010	5,75	9,55	5,70	9,55	39,6	6,35	brown
500/0	–	0	030-8614-000	9,10	13,55	11,5	14,35	41,0	6,35	–
	50,0	–	030-8592-000	9,10	13,55	10,7	14,35	41,0	6,35	–
	25,0	4	030-8614-010	9,10	13,55	7,60	14,35	41,0	6,35	white
	35,0	2	030-8614-020	9,10	13,55	9,10	14,35	41,0	6,35	grey
	16,0	–	030-8614-030	9,10	13,55	6,20	14,35	41,0	6,35	–

## ACCESSORIES

### CONTACTS

Standard contacts and contacts with reduced termination diameter

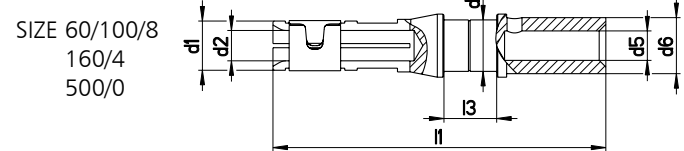
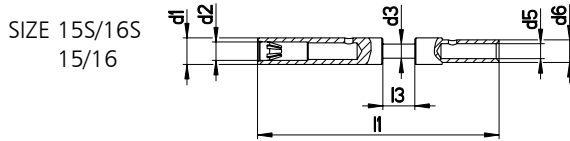
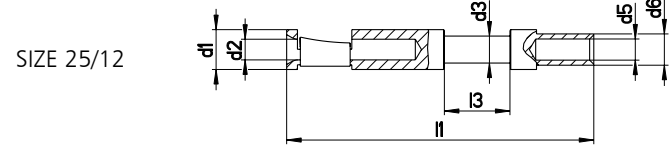
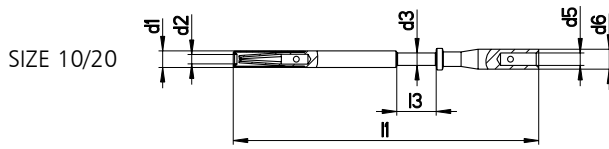

#### Socket contacts Finish: A36–5 $\mu$ m silver plated and passivated

Contact size	Wire size		Part no.	d1	d2 + 0,05	d3	d5	d6	l1 $\pm 0,2$	l3 $\pm 0,1$	Color code
	mm <sup>2</sup>	AWG									
10/20	0,5–1,0	20/18	031-8554-000	2,0	1,07	1,5	1,5	2,4	36,8 $\pm 0,3$	4,75	–
	0,2–0,4	26/22	031-8554-010	2,0	1,07	1,5	0,9	2,4	36,8 $\pm 0,3$	4,75	blue
15S/16S	0,75–1,5	18/16	031-8555-110	3,2	1,65	1,75	1,75	2,75	29,1	3,9	–
	0,3–0,6	22/20	031-8688-110	3,2	1,65	1,75	1,2	2,75	29,1	3,9	red
	0,14–0,38	22/26	031-8555-130	3,2	1,65	1,75	0,9	2,75	29,1	3,9	blue
15/16	0,75–1,5	18/16	031-8556-110	3,2	1,65	1,75	1,75	2,75	37,8	7,9	–
	0,3–0,6	22/20	031-8639-120	3,2	1,65	1,75	1,2	2,75	37,8	7,9	red
	0,14–0,38	22/26	031-8556-130	3,2	1,65	1,75	0,9	2,75	37,8	7,9	blue
25/12	2,0–3,0	14/12	031-8557-000	4,8	2,45	3,3	2,5	3,8	37,0	7,9	–
	0,75–1,5	18/16	031-8557-020	4,8	2,45	3,3	1,75	3,4	37,0	7,9	black
	4,0	–	031-8557-010	4,8	2,45	3,3	2,8	3,8	37,0	7,9	–
	0,3–0,6	22/20	031-8557-040	4,8	2,45	3,3	1,2	2,75	37,0	7,9	–
60/100/8	–	8	031-8519-000	6,5	3,65	6,25	4,55	6,8	40,1	6,35	–
	6,0	10	031-8558-000	6,5	3,65	6,25	3,5	6,8	40,1	6,35	yellow
	10,0	–	031-8559-000	6,5	3,65	6,25	4,8	6,8	40,1	6,35	–
	2,0–3,0	14/12	031-8519-010	6,5	3,65	6,25	2,5	6,8	40,1	6,35	green
160/4	–	4	031-8520-000	8,6	5,8	9,55	7,1	9,55	40,1	6,35	–
	16,0	–	031-8560-000	8,6	5,8	9,55	6,2	9,55	40,1	6,35	–
	10,0	–	031-8560-020	8,6	5,8	9,55	4,8	9,55	40,1	6,35	–
	–	6	031-8520-010	8,6	5,8	9,55	5,7	9,55	40,1	6,35	brown
500/0	–	0	031-8521-000	13,2	9,15	13,55	11,5	14,35	41,6	6,35	–
	50,0	–	031-8561-000	13,2	9,15	13,55	10,7	14,35	41,6	6,35	–
	25,0	4	031-8521-010	13,2	9,15	13,55	7,6	14,35	41,6	6,35	white
	35,0	2	031-8521-020	13,2	9,15	13,55	9,1	14,35	41,6	6,35	grey
	16,0	–	031-8521-030	13,2	9,15	13,55	6,2	14,35	41,6	6,35	–

#### Remark:

For Socket contact installation the following guiding pins are essential:

Contact size	Part number
guide pin # 15/16 and 15S/16	27977-16T50
guide pin # 12/25	27977-12T8

## ACCESSORIES

### TOOLING FOR CONTACT CRIMPING AND INSTALLATION

#### HAND CRIMP TOOL M22520-1-01 PART NUMBER 995-0001-585



Contact size	Wire size		Crimp Locator	Order Reference
	mm <sup>2</sup>	AWG		
10	0,5–1,0	20/18	600325	121586-0034
	0,2–0,4	26/22		
Pin 15S/16S	0,75–1,5	18/16	TH 452	995-0002-052
	0,3–0,6	22/20		
	0,14–0,38	22/26		
Socket 15S/S16	0,75–1,5	18/16	TH 452	995-0002-052
	0,3–0,6	22/20		
	0,14–0,38	22/26		
15/16	0,75–1,5	18/16	TH 452	995-0002-052
	0,3–0,6	22/20		
	0,14–0,38	22/26		
25/12	2,0–3,0	14/12	TH 452	995-0002-052
	0,75–1,5	18/16		
	4,0	–		

#### HYDRAULIC HANDCRIMP TOOL HPW400U-ITT PART NUMBER 121586-5257



Contact size	Wire size		Specifics
	mm <sup>2</sup>	AWG	
60/100/8	6,0	8	The hydraulic handcrimp tool HPW400U-ITT is delivered without crimp dies. Please order your specific crimp dies separately, on page 44
	2,0–3,0	10	
	–	14/12	
160/4	16,0	4	The hydraulic handcrimp tool HPW400U-ITT is delivered without crimp dies. Please order your specific crimp dies separately, on page 44
	10,0	6	
	–	–	
500/0	–	0	The hydraulic handcrimp tool HPW400U-ITT is delivered without crimp dies. Please order your specific crimp dies separately, on page 44
	50,0	–	
	25,0	4	
	35,0	2	
	16,0	–	

#### ELECTRO HYDRAULIC TOOL HP700EL-ITT PART NUMBER 121586-5279



Contact size	Wire size		Specifics
	mm <sup>2</sup>	AWG	
60/100/8	6,0	8	The electro-hydraulic tool HP700EL-ITT is delivered with an H-crimp head (table mount), foot pedal and hand control. Please order crimp dies as well as switch mode power supply or lithium-ion battery separately - details below.
	2,0–3,0	10	
	–	14/12	
160/4	16,0	4	The electro-hydraulic tool HP700EL-ITT is delivered with an H-crimp head (table mount), foot pedal and hand control. Please order crimp dies as well as switch mode power supply or lithium-ion battery separately - details below.
	10,0	6	
	–	–	
500/0	–	0	The electro-hydraulic tool HP700EL-ITT is delivered with an H-crimp head (table mount), foot pedal and hand control. Please order crimp dies as well as switch mode power supply or lithium-ion battery separately - details below.
	50,0	–	
	25,0	4	
	35,0	2	
	16,0	–	

#### ACCESSORIES FOR ELECTR HYDRAULIC CRIMP TOOL HP700EL-ITT PART NUMBER 121586-5279

Description	Marking	Part Number
Switch mode power supply	SNT4-ITT	121586-5280
Lithium Ion Battery 18V 3A with recharger	LGA4-ITT	121586-5281

## ACCESSORIES

### TOOLING FOR CONTACT INSERTION AND EXTRACTION

#### INSERTION AND EXTRACTION TOOLS



##### Insertion Tools

Type	CIT 20	CIT 16	CIT12	CIT 8	CIT 4	CIT 0
Part No.	121086-3009	121086-3008	121086-3007	121086-0095	121086-0094	121086-0093

##### Insertion Pliers

Type	CIT-F80-20	CIT-F80-16	CIT-F80-12
Part No.	121086-0098	121086-0097	121086-0096

##### Extraction Tools

Type	CET-F80-20	CET-F80-16	CET-F80-12	CET-8	CET-4	CET-0
Part No.	121086-0082	121086-0081	121086-0080	121086-0079	121086-0078	121086-0077

#### CRIMP DIES FOR MS/CA, VG95234



Contact size	Wire size		Hex. Diameter	Stamped Label	Part Number
	mm <sup>2</sup>	AWG			
60/100/8	6/10	8	5,20	01	121586-5231
160/4	16	4	7,25	02	121586-5230
500/0	50,0	0	11,40	03	121586-5229

Locator for MS/CA, part number 121586-5232

#### Notes:

1. For large series production, semi-automatic crimp machine Type HACS-IV-MSXX upon request
2. For insertion and extraction of the contacts and for connector assembly see "Assembly instructions SAE-AS50151/VG95234
3. Standard contacts acc. to SAE-AS50151/VG95234



## PRODUCT SAFETY INFORMATION

### 1. MATERIAL CONTENT AND PHYSICAL FORM

Electrical connectors do not usually contain hazardous materials. They contain conducting and non-conducting materials and can be divided into two groups.

a) Printed circuit types and low cost audio types which employ all plastic insulators and casings.

b) Rugged, Fire Barrier and High Reliability types with metal casings and either natural rubber, synthetic rubber, plastic or glass insulating materials. Contact materials vary with type of connector and also application and are usually manufactured from either: Copper, copper alloys, nickel, alumel, chromel or steel. In special applications, other alloys may be specified.

### CAUTION

### 2. FIRE CHARACTERISTICS AND ELECTRIC SHOCK HAZARD

There is no fire hazard when the connector is correctly wired and used within the specified parameters.

Incorrect wiring or assembly of the connector or careless use of metal tools or conductive fluids, or transit damage to any of the component parts may cause electric shock or burns. Live circuits must not be broken by separating mated connectors as this may cause arcing, ionization and burning. Heat dissipation is greater at maximum resistance in a circuit. Hot spots may occur when resistance is raised locally by damage, e.g. cracked or deformed contacts, broken strands of wire. Local overheating may also result from the use of the incorrect application tools or from poor quality soldering or slack screw terminals. Overheating may occur if the ratings in the product Data Sheet/Catalog are exceeded and can cause breakdown of insulation and hence electric shock. If heating is allowed to continue it intensifies by further increasing the local resistance through loss of temper of spring contacts, formation of oxide film on contacts and wires and leakage currents through carbonization of insulation and tracking paths. Fire can then result in the presence of combustible materials and this may release noxious fumes. Overheating may not be visually apparent. Burns may result from touching overheated components.

### 3. HANDLING

Care must be taken to avoid damage to any component parts of electrical connectors during installation and use. Although there are normally no sharp edges, care must be taken when handling certain components to avoid injury to fingers.

Electrical connectors may be damaged in transit to the customers, and damage may result in creation of hazards. Products should therefore be examined prior to installation/use and rejected if found to be damaged.

### 4. DISPOSAL

Incineration of certain materials may release noxious or even toxic fumes.

### 5. APPLICATION

Connectors with exposed contacts should not be selected for use on the current supply side of an electrical circuit, because an electric shock could result from touching exposed contacts on an unmated connector. Voltages in excess of 30V ac or 42.5V DC are potentially hazardous and care should be taken to ensure that such voltages cannot be transmitted in any way to exposed metal parts of the connector body. The connector and wiring should be checked, before making live, to have no damage to metal parts or insulators, no solder blobs, loose strands, conducting lubricants, swarf, or any other undesired conducting particles. Circuit resistance and continuity check should be made to make certain that there are no high resistance joints or spurious conducting paths. Always use the correct application tools as specified in the Data Sheet/Catalog. Do not permit untrained personnel to wire, assemble or tamper with connectors. For operation voltage please see appropriate national regulations.

### IMPORTANT GENERAL INFORMATION

(i) **Air and creepage paths/Operating voltage.** The admissible operating voltages depend on the individual applications and the valid national and other applicable safety regulations. For this reason the air and creepage path data are only reference values. Observe reduction of air and creepage paths due to PC board and/or harnessing.

#### (ii) Temperature

All information given are temperature limits. The operation temperature depends on the individual application.

#### (iii) Other important information

Cannon continuously endeavors to improve their products. Therefore, Cannon products may deviate from the description, technical data and shape as shown in this catalog and data sheets.

ITT Cannon manufactures the highest quality products available in the marketplace; however these products are intended to be used in accordance with the specifications

in this publication. Any use or application that deviates from the stated operating specifications is not recommended and may be unsafe. No information and data contained in this publication shall be construed to create any liability on the part of Cannon. Any new issue of this publication shall automatically invalidate and supersede any and all previous issues.



cannon

Amazing things  
happen when great  
things connect



Connect with your ITT Cannon representative today  
or visit us at [www.ittcannon.com](http://www.ittcannon.com)

## Connect with the experts

ITT's Cannon brand is a world leader in the design and manufacture of highly engineered connector solutions for multiple end markets.



ENGINEERED FOR LIFE

---

### North America

56 Technology Drive  
Irvine, CA 92618  
Phone: +1.800.854.3028

### Europe

Italy  
Corso Europa 41/43  
20020 Lainate (MI), Italy  
Phone: +39.02938721

Germany  
Cannonstrasse 1  
71384 Weinstadt, Germany  
Phone: +49.7151.699.0

### Asia

Tuopandun Industrial Area, Jinda Cheng,  
Xiner Village, Shajing Town, Boan District,  
Shenzhen City, Guangdong Province, China 518215  
Phone: +86.755.2726.7888

## X-ON Electronics

Largest Supplier of Electrical and Electronic Components

*Click to view similar products for [Circular MIL Spec Connector](#) category:*

*Click to view products by [ITT](#) manufacturer:*

Other Similar products are found below :

[89075GULPR](#) [0025-264-3014](#) [58-570121-04S](#) [58-584653-12P](#) [0134-213-1007](#) [0134-213-1208](#) [0134-213-2209](#) [0025-258-000](#) [60-042022-02P](#) [60-042022-19P](#) [60-042022-23P](#) [012-0467-000](#) [602GB06EG24-61SN](#) [0134-201-1207](#) [0134-207-2009](#) [0134-213-1006](#) [6104-207-2302](#) [6104-208-1902](#) [6131-202-19149P](#) [6131-204-21149P](#) [6131-207-13149P](#) [6131-208-13149P](#) [6131-209-17149P](#) [6131-210-11149P](#) [6131-211-19149P](#) [6131-216-19149P](#) [6131-220-25149P](#) [6131-259-11149P](#) [6131-259-21149P](#) [6131-259-23149P](#) [6131-263-19149P](#) [6131-265-17149P](#) [6131-265-19149P](#) [6134-203-21149](#) [CS3100A18-1P-472](#) [CS3100A-36-77S](#) [CS3101A36-79S-SR](#) [CS3102A-10SL-53P](#) [CS3102A10SL-64S](#) [CS3102A-20-15S](#) [CS3102A-22-70S](#) [CS3102A-24-79S](#) [CS3102A24-AJS](#) [CS3102A-32-17P](#) [CS3102A32-25S](#) [CS3106A10SL3S004](#) [CS3106A-18-73S](#) [CS3106A-28-20P](#) [CS3106A-32-82S](#) [CS3106A36-79P-SR](#)