

For connector style A, B1, B2, C1, C2, F, J1, J2, N1 and N2 resp. CA3100, CA3101, CA3102 and TBF

- A = Contact size 10
- B = Contact size 15S, 15, 16S, 16
- C = Contact size 25, 12
- D = Contact size 60, 100, 160, 500, 8,4, 0
- E = Contact size 10
- F = Contact size 15S, 16S
- G = all others

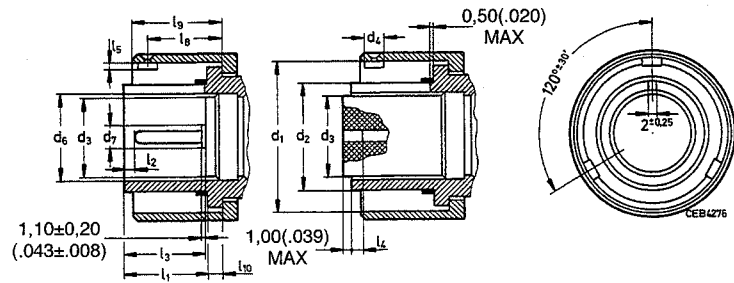

Dimensions in mm

Shell Size	d ₁ -0,15	d ₂ +0,30	d ₃	d ₄ -0,10	d ₆	l ₁ ±0,20	l ₂ ±1,00 A	B	C	D	l ₃ ±0,50	l ₄ ±1,00 E	F	G	l ₅ +0,05 -0,10	l ₆ ±1,00	l ₇ ±0,50	l ₈ +0,10 -0,05
10SL	18,20	11,30	9,70 ^{+0,25} _{-0,3}	2,60	10,00 ^{+0,2}	13,50	-	2,20	-	-	12,80	-	2,00	-	1,60	11,80	14,00	2,10
12S	21,40	14,00	10,80 ^{+0,25} _{-0,3}	2,60	11,40 ^{+0,6}	13,50	-	2,20	-	-	12,80	-	2,00	-	1,60	11,80	14,00	2,10
14S	24,80	17,10	13,00 ^{+0,25} _{-0,3}	2,60	13,30 ^{+0,6}	13,50	-	2,20	-	-	12,80	-	2,00	-	1,60	11,80	14,00	2,10
16S	27,60	20,40	16,10 ^{+0,25} _{-0,3}	2,60	16,40 ^{+0,6}	13,50	-	2,20	-	-	12,80	-	2,00	-	1,60	11,80	14,00	2,10
16	27,60	20,40	16,10 ^{+0,25} _{-0,3}	4,50	16,40 ^{+0,6}	18,20	9,80	6,60	3,00	2,30	17,60	1,40	-	2,60	1,60	16,00	18,80	2,10
18	31,10	23,60	18,80 ^{+0,4}	4,50	19,60 ^{+0,6}	18,20	9,80	6,60	3,00	2,30	17,60	1,40	-	2,60	1,80	16,00	18,80	2,10
20	34,50	26,70	22,60 ^{+0,4}	4,50	23,60 ^{+0,6}	18,20	9,80	6,60	3,00	2,30	17,60	1,40	-	2,60	1,80	16,00	18,80	2,10
22	37,70	29,80	25,10 ^{+0,4}	4,50	26,00 ^{+0,6}	18,20	9,80	6,60	3,00	2,30	17,60	1,40	-	2,60	1,80	16,00	18,80	2,10
24	41,20	33,00	28,20 ^{+0,4}	4,50	29,10 ^{+0,7}	18,20	9,80	6,60	3,00	2,30	17,60	1,40	-	2,60	1,80	16,80	18,80	2,80
28	47,00	38,60	33,60 ^{+0,4}	4,50	34,70 ^{+0,7}	18,20	9,80	6,60	3,00	2,30	17,60	1,40	-	2,60	1,80	16,80	18,80	2,80
32	53,70	44,90	40,00 ^{+0,4}	4,50	41,00 ^{+0,7}	18,20	9,80	6,60	3,00	2,30	17,60	1,40	-	2,60	1,80	16,80	18,80	2,80
36	59,90	50,30	45,50 ^{+0,4}	4,50	46,60 ^{+0,7}	19,00	9,80	6,60	3,00	2,30	17,60	1,40	-	2,60	1,80	16,80	18,80	2,80

Dimensions in inches

Shell Size	d ₁ -0,006	d ₂ +0,012	d ₃	d ₄ -0,004	d ₆	l ₁ ±0,008	l ₂ ±0,039 A	B	C	D	l ₃ ±0,020	l ₄ ±0,039 E	F	G	l ₅ +0,002 -0,004	l ₆ ±0,039	l ₇ ±0,020	l ₈ +0,004 -0,002
10SL	.717	.445	.382 ^{+0,010} _{-0,012}	.102	.394 ^{+0,012}	.531	-	.087	-	-	.504	-	.079	-	.063	.465	.551	.083
12S	.843	.551	.425 ^{+0,010} _{-0,012}	.102	.449 ^{+0,024}	.531	-	.087	-	-	.504	-	.079	-	.063	.465	.551	.083
14S	.976	.673	.512 ^{+0,010} _{-0,012}	.102	.524 ^{+0,024}	.531	-	.087	-	-	.504	-	.079	-	.063	.465	.551	.083
16S	1.087	.803	.634 ^{+0,010} _{-0,012}	.102	.646 ^{+0,024}	.531	-	.087	-	-	.504	-	.079	-	.063	.465	.551	.083
16	1.087	.083	.634 ^{+0,010} _{-0,012}	.177	.646 ^{+0,024}	.717	.386	.260	.118	.091	.693	.055	-	.102	.063	.630	.740	.083
18	1.224	.929	.740 ^{+0,016}	.177	.772 ^{+0,024}	.717	.386	.260	.118	.091	.693	.055	-	.102	.071	.630	.740	.083
20	1.358	1.051	.890 ^{+0,016}	.177	.929 ^{+0,024}	.717	.386	.260	.118	.091	.693	.055	-	.102	.071	.630	.740	.083
22	1.484	1.173	.988 ^{+0,016}	.177	1.024 ^{+0,024}	.717	.386	.260	.118	.091	.693	.055	-	.102	.071	.630	.740	.083
24	1.622	1.299	1.110 ^{+0,016}	.177	1.146 ^{+0,028}	.717	.386	.260	.118	.091	.693	.055	-	.102	.071	.661	.740	.110
28	1.850	1.520	1.323 ^{+0,016}	.177	1.366 ^{+0,028}	.717	.386	.260	.118	.091	.693	.055	-	.102	.071	.661	.740	.110
32	2.114	1.768	1.575 ^{+0,016}	.177	1.614 ^{+0,028}	.717	.386	.260	.118	.091	.693	.055	-	.102	.071	.661	.740	.110
36	2.358	1.980	1.791 ^{+0,016}	.177	1.835 ^{+0,028}	.748	.386	.260	.118	.091	.693	.055	-	.102	.071	.661	.740	.110

* In terminated condition

Mating Dimensions

For shell styles K, L and M, shown without coupling nut

Size	d_2 min
14S	17,90 (.705)
16S	21,20 (.835)
16	21,20 (.835)
18	24,40 (.961)
20	27,60 (1.087)

Size	d_2 min
22	30,70 (1.209)
24	33,90 (1.335)
28	39,50 (1.555)
32	46,00 (1.811)
36	51,40 (2.024)

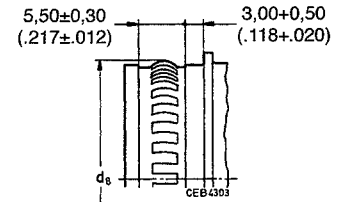

Plastic Protecting Caps

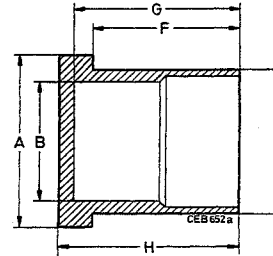

Colour: red
(similar to RAL 2003)

Part No.	Protecting Cap For		$\varnothing A$ max	$\varnothing B$ -0,20 (.008)	$\varnothing D$ +0,20 (.008)	F $\pm 0,20$ (.008)	G $\pm 0,20$ (.008)	H max
	Receptacles Shell Size	Plugs Shell Size						
025-8636-005	10S/10SL	-	22,80 (.898)	17,70 (.697)	19,70 (.776)	10,70 (.421)	14,20 (.559)	15,90 (.626)
025-8636-006	-	10S/10SL	22,80 (.898)	10,70 (.421)	12,90 (.508)	15,50 (.610)	17,00 (.669)	18,70 (.626)
025-8636-008	-	12S	26,00 (1.024)	13,40 (.528)	15,80 (.622)	15,50 (.610)	17,00 (.669)	18,70 (.736)
025-8636-010	12S/12	-	26,00 (1.024)	20,90 (.823)	22,90 (.902)	10,70 (.421)	14,20 (.559)	15,90 (.626)
025-8636-016	14S/14	-	29,20 (1.150)	24,10 (.949)	26,10 (1.028)	10,70 (.421)	14,20 (.559)	15,90 (.626)
025-8636-017	-	14S	29,20 (1.150)	16,50 (.650)	19,10 (.752)	15,50 (.610)	17,00 (.669)	18,70 (.736)
025-8636-018	-	14	29,20 (1.150)	16,50 (.650)	19,10 (.752)	20,20 (.795)	21,70 (.854)	23,40 (.921)
025-8636-022	-	16S	32,00 (1.260)	19,80 (.780)	22,40 (.882)	15,50 (.610)	17,00 (.669)	18,70 (.736)
025-8636-024	-	16	32,00 (1.260)	19,80 (.780)	22,40 (.882)	20,20 (.795)	21,70 (.854)	23,40 (.921)
025-8636-025	16S	-	32,00 (1.260)	26,90 (1.059)	28,90 (1.138)	10,70 (.421)	14,20 (.559)	15,90 (.626)
025-8636-026	16	-	32,00 (1.260)	26,90 (1.059)	28,90 (1.138)	17,50 (.689)	19,00 (.748)	20,70 (.815)
025-8636-034	18	-	36,50 (1.437)	30,30 (1.193)	32,30 (1.272)	17,50 (.689)	19,00 (.748)	20,70 (.815)
025-8636-036	-	18	36,50 (1.437)	23,00 (.906)	25,60 (1.008)	20,20 (.795)	21,70 (.854)	23,40 (.921)
025-8636-042	20	-	39,90 (1.571)	33,70 (1.327)	35,70 (1.406)	17,50 (.689)	19,00 (.748)	20,70 (.815)
025-8636-044	-	-	39,90 (1.571)	26,10 (1.028)	28,80 (1.134)	20,20 (.795)	21,70 (.854)	23,40 (.921)
025-8636-048	-	22	43,10 (1.697)	29,20 (1.150)	31,90 (1.256)	20,20 (.795)	21,70 (.854)	23,40 (.921)
025-8636-049	22	-	43,10 (1.697)	36,90 (1.453)	38,90 (1.531)	17,50 (.689)	19,00 (.748)	20,70 (.815)
025-8636-053	24	-	46,60 (1.835)	40,40 (1.591)	42,40 (1.669)	19,10 (.752)	20,60 (.811)	22,30 (.878)
025-8636-054	-	24	46,60 (1.835)	32,40 (1.276)	35,10 (1.382)	20,20 (.795)	21,70 (.854)	23,40 (.921)
025-8636-058	28	-	53,40 (2.102)	46,20 (1.819)	48,20 (1.898)	19,10 (.752)	20,60 (.811)	22,30 (.878)
025-8636-060	-	28	53,40 (2.102)	38,00 (1.496)	40,70 (1.602)	20,20 (.795)	21,70 (.854)	23,40 (.921)
025-8636-061	-	32	60,10 (2.366)	44,30 (1.774)	47,20 (1.858)	20,20 (.795)	21,70 (.854)	23,40 (.921)
025-8636-062	32	-	60,10 (2.366)	52,90 (2.083)	54,90 (2.161)	20,70 (.795)	22,20 (.874)	23,90 (.941)

Metal Protecting Caps

For receptacles, shell style 3100, 3101 and 3102
Material: Aluminum Alloy

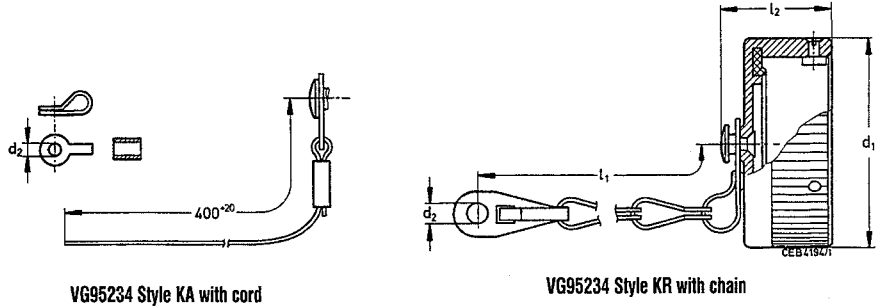

Dimensions in mm

Shell Size	VG95234 Part No. With Chain	VG95234 Part No. With Cord	Cannon Part No. With Chain	Cannon Part No. With Cord	d ₁ max	d ₂ +0,6	l ₁ min for Chain	l ₂ max	Weight g max
10SL	VG95234KR10SL	VG95234KA10SL	CA121003-1	CAB81-10SL-D	23,50	4,30	90,00	20,00	16
12S	VG95234KR12S	VG95234KA12S	CA121003-2	CAB81-12S-D	27,00	4,30	90,00	20,00	17
14S	VG95234KR14S	VG95234KA14S	CA121003-3	CAB81-14S-D	30,50	4,30	90,00	20,00	18
16S	VG95234KR16S	VG95234KA16S	CA121003-4	CAB81-16S-D	33,00	4,30	90,00	20,00	19
16	VG95234KR16	VG95234KA16	CA121003-5	CAB81-16-D	33,00	4,30	100,00	25,00	23
18	VG95234KR18	VG95234KA18	CA121003-6	CAB81-18-D	37,50	4,30	100,00	25,00	27
20	VG95234KR20	VG95234KA20	CA121003-7	CAB81-20-D	41,00	4,30	115,00	25,00	30
22	VG95234KR22	VG95234KA22	CA121003-8	CAB81-22-D	44,00	4,30	115,00	25,00	33
24	VG95234KR24	VG95234KA24	CA121003-9	CAB81-24-D	47,50	4,30	115,00	25,00	37
28	VG95234KR28	VG95234KA28	CA121003-10	CAB81-28-D	54,50	5,50	160,00	25,00	42
32	VG95234KR32	VG95234KA32	CA121003-11	CAB81-32-D	61,00	5,50	160,00	25,00	48
36	VG95234KR36	VG95234KA36	CA121003-12	CAB81-36-D	67,50	5,50	160,00	25,00	50

Dimensions in inches

Shell Size	VG95234 Part No. With Chain	VG95234 Part No. With Cord	Cannon Part No. With Chain	Cannon Part No. With Cord	d ₁ max	d ₂ +.024	l ₁ min for Chain	l ₂ max	Weight g max
10SL	VG95234KR10SL	VG95234KA10SL	CA121003-1	CAB81-10SL-D	.925	.169	3.543	.787	16
12S	VG95234KR12S	VG95234KA12S	CA121003-2	CAB81-12S-D	1.063	.169	3.543	.787	17
14S	VG95234KR14S	VG95234KA14S	CA121003-3	CAB81-14S-D	1.201	.169	3.543	.787	18
16S	VG95234KR16S	VG95234KA16S	CA121003-4	CAB81-16S-D	1.299	.169	3.543	.787	19
16	VG95234KR16	VG95234KA16	CA121003-5	CAB81-16-D	1.299	.169	3.937	.984	23
18	VG95234KR18	VG95234KA18	CA121003-6	CAB81-18-D	1.476	.169	3.937	.984	27
20	VG95234KR20	VG95234KA20	CA121003-7	CAB81-20-D	1.614	.169	4.528	.984	30
22	VG95234KR22	VG95234KA22	CA121003-8	CAB81-22-D	1.732	.169	4.528	.984	33
24	VG95234KR24	VG95234KA24	CA121003-9	CAB81-24-D	1.870	.169	4.528	.984	37
28	VG95234KR28	VG95234KA28	CA121003-10	CAB81-28-D	2.146	.217	6.300	.984	42
32	VG95234KR32	VG95234KA32	CA121003-11	CAB81-32-D	2.402	.217	6.300	.984	48
36	VG95234KR36	VG95234KA36	CA121003-12	CAB81-36-D	2.657	.217	6.300	.984	55

Metal Protecting Caps

For plugs, shell style 3106 and 3108
Material: Aluminum Alloy

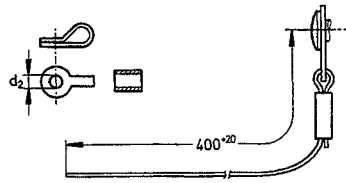

VG95234 Style KC with cord

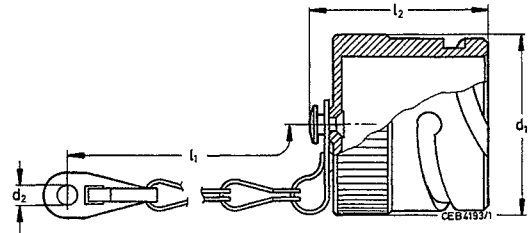

VG95234 Style KB with chain

Dimensions in mm

Shell Size	VG95234 Part No. With Chain	VG95234 Part No. With Cord	Cannon Part No. With Chain	Cannon Part No. With Cord	d ₁ max	d ₂	l ₁	l ₂ max	Weight g max
10SL	VG95234KB10SL	VG95234KC10SL	CA121004-1	CAB80-10SL-D	21,00	4,30	90,00	29,00	19
12S	-	-	CA121004-2	CAB80-12S-D	24,00	4,30	100,00	29,00	23
14S	VG95234KB14S	VG95234KC14S	CA121004-3	CAB80-14S-D	27,50	4,30	100,00	29,00	26
16S	VG95234KB16S	VG95234KC16S	CA121004-4	CAB80-16S-D	30,00	4,30	100,00	29,00	28
16	VG95234KB16	VG95234KC16	CA121004-5	CAB80-16-D	30,00	4,30	115,00	37,00	33
18	VG95234KB18	VG95234KC18	CA121004-6	CAB80-18-D	33,50	4,30	115,00	37,00	36
28	VG95234KB20	VG95234KC20	CA121004-7	CAB80-20-B	37,00	4,70	130,00	37,00	43
22	VG95234KB22	VG95234KC22	CA121004-8	CAB80-22-D	40,00	4,70	130,00	37,00	47
24	VG95234KB24	VG95234KC24	CA121004-9	CAB80-24-D	43,50	4,70	130,00	37,00	53
28	VG95234KB28	VG95234KC28	CA121004-10	CAB80-28-D	49,50	4,70	190,00	37,00	63
32	VG95234KB32	VG95234KC32	CA121004-11	CAB80-32-D	56,00	5,50	190,00	37,00	75
36	VG95234KB36	VG95234KC36	CA121004-12	CAB80-36-D	62,50	5,50	190,00	37,00	88

Dimensions in inches

Shell Size	VG95234 Part No. With Chain	VG95234 Part No. With Cord	Cannon Part No. With Chain	Cannon Part No. With Cord	d ₁ max	d ₂	l ₁	l ₂ max	Weight g max
10SL	VG95234KB10SL	VG95234KC10SL	CA121004-1	CAB80-10SL-D	.827	.169	3.543	1.142	19
12S	-	-	CA121004-2	CAB80-12S-D	.945	.169	3.937	1.142	23
14S	VG95234KB14S	VG95234KC14S	CA121004-3	CAB80-14S-D	1.083	.169	3.937	1.142	26
16S	VG95234KB16S	VG95234KC16S	CA121004-4	CAB80-16S-D	1.181	.169	3.937	1.142	28
16	VG95234KB16	VG95234KC16	CA121004-5	CAB80-16-D	1.181	.169	4.528	1.457	33
18	VG95234KB18	VG95234KC18	CA121004-6	CAB80-18-D	1.319	.169	4.528	1.457	36
28	VG95234KB20	VG95234KC20	CA121004-7	CAB80-20-B	1.457	.185	5.118	1.457	43
22	VG95234KB22	VG95234KC22	CA121004-8	CAB80-22-D	1.575	.185	5.118	1.457	47
24	VG95234KB24	VG95234KC24	CA121004-9	CAB80-24-D	1.713	.185	5.118	1.457	53
28	VG95234KB28	VG95234KC28	CA121004-10	CAB80-28-D	1.949	.185	7.480	1.457	63
32	VG95234KB32	VG95234KC32	CA121004-11	CAB80-32-D	2.205	.217	7.480	1.457	75
36	VG95234KB36	VG95234KC36	CA121004-12	CAB80-36-D	2.461	.217	7.480	1.457	88

Dummy Receptacles

Front panel mounting (rear side open)

VG95234 Style BOD (Flange with through-holes)
CA3105-B

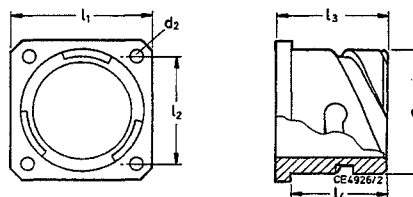

Dimensions in mm

Shell Size	VG95234 Part No.	Cannon Part No.	d ₁ -0,15	d ₂ ±0,2	l ₁ ±0,3	l ₂ ±0,1	l ₃ max	l ₄ +0,3
10SL	VG95234BOD10SL	CA3105E10SL-B	18,20	3,20	25,40	18,20	17,50	14,20
12S	-	CA3105E12S-B	21,40	3,20	28,00	20,60	18,00	14,20
14S	VG95234BOD14S	CA3105E14S-B	24,60	3,20	30,00	23,00	18,00	14,20
16S	VG95234BOD16S	CA3105E16S-B	27,40	3,20	32,50	24,60	18,00	14,20
16	VG95234BOD16	CA3105E16-B	27,40	3,20	32,50	24,60	23,50	19,00
18	VG95234BOD18	CA3105E18-B	30,80	3,20	35,00	27,00	23,50	19,00
20	VG95234BOD20	CA3105E20-B	34,20	3,20	38,00	29,40	23,50	19,00
22	VG95234BOD22	CA3105E22-B	37,40	3,20	41,00	31,80	23,50	19,00
24	VG95234BOD24	CA3105E24-B	40,90	3,70	44,50	34,90	25,50	20,60
28	VG95234BOD28	CA3105E28-B	46,70	3,70	50,80	39,70	25,50	20,60
32	VG95234BOD32	CA3105E32-B	53,40	4,30	57,00	44,50	27,00	22,20
36	VG95234BOD36	CA3105E36-B	59,60	4,30	63,50	49,20	27,00	22,20

Dimensions in inches

Shell Size	VG95234 Part No.	Cannon Part No.	d ₁ -.006	d ₂ ±.008	l ₁ ±.012	l ₂ ±.004	l ₃ max	l ₄ ±.012
10SL	VG95234BOD10SL	CA3105E10SL-B	.717	.126	1.000	.717	.689	.559
12S	-	CA3105E12S-B	.843	.126	1.102	.811	.709	.559
14S	VG95234BOD14S	CA3105E14S-B	.969	.126	1.181	.906	.709	.559
16S	VG95234BOD16S	CA3105E16S-B	1.079	.126	1.280	.969	.709	.559
16	VG95234BOD16	CA3105E16-B	1.079	.126	1.280	.969	.925	.748
18	VG95234BOD18	CA3105E18-B	1.213	.126	1.378	1.063	.925	.748
20	VG95234BOD20	CA3105E20-B	1.346	.126	1.496	1.157	.925	.748
22	VG95234BOD22	CA3105E22-B	1.472	.126	1.614	1.252	.925	.748
24	VG95234BOD24	CA3105E24-B	1.610	.146	1.752	1.374	1.004	.811
28	VG95234BOD28	CA3105E28-B	1.839	.146	2.000	1.563	1.004	.811
32	VG95234BOD32	CA3105E32-B	2.102	.169	2.244	1.752	1.063	.874
36	VG95234BOD36	CA3105E36-B	2.346	.169	2.500	1.937	1.063	.874

Dummy Receptacles

Rear panel mounting (rear side closed)

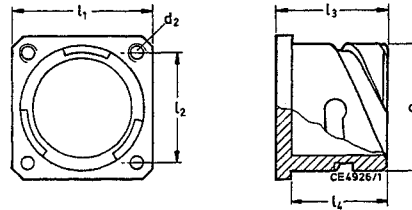

Dimensions in mm

Shell Size	CA3105E-B Cannon Part No. With Thread Style A	CA3105E-B-05 Cannon Part No. With Through Holes Style B	d ₁	l ₁ ±0,25	l ₂ ±0,3	l ₃	l ₄ +0,3	Style A d ₂	Style B d ₂ ±0,2
10SL	248-8513-000	248-8501-000	18,20	25,40	18,20	21,10	18,30	M4	3,20
12S	248-8514-000	248-8502-000	21,40	28,00	20,60	21,50	18,30	M4	3,20
14S	248-8515-000	248-8503-000	24,60	30,00	23,00	21,50	18,30	M4	3,20
16S	248-8516-000	248-8504-000	27,40	32,50	24,60	21,50	18,30	M4	3,20
16	248-8517-000	248-8505-000	27,40	32,50	24,60	24,80	21,60	M4	3,20
18	248-8518-000	248-8506-000	30,80	35,00	27,00	27,20	23,15	M4	3,20
20S	248-8519-000	248-8507-000	34,20	38,00	29,40	27,20	23,15	M4	3,20
22	248-8520-000	248-8508-000	37,40	41,00	31,80	27,20	23,15	M4	3,20
24	248-8521-000	248-8509-000	40,90	44,50	34,90	27,20	23,15	M4	3,70
28	248-8522-000	248-8510-000	46,70	50,80	39,70	28,20	24,15	M5	3,70
32	248-8523-000	248-8511-000	53,40	57,00	44,50	28,20	24,15	M5	4,40
36	248-8524-000	248-8512-000	59,60	63,50	49,20	28,20	24,15	M5	4,40

Dimensions in inches

Shell Size	Cannon Part No. With Thread Style A	Cannon Part No. With Through Holes Style B	d ₁	l ₁ ±.010	l ₂ ±.012	l ₃	l ₄ ±.012	Style A d ₂	Style B d ₂ ±.008
10SL	248-8513-000	248-8501-000	.717	1.000	.717	.831	.720	M4	.126
12S	248-8514-000	248-8502-000	.843	1.102	.811	.846	.720	M4	.126
14S	248-8515-000	248-8503-000	.969	1.181	.906	.846	.720	M4	.126
16S	248-8516-000	248-8504-000	1.079	1.280	.969	.846	.720	M4	.126
16	248-8517-000	248-8505-000	1.079	1.280	.969	.973	.850	M4	.126
18	248-8518-000	248-8506-000	1.213	1.378	1.063	1.071	.911	M4	.126
20S	248-8519-000	248-8507-000	1.346	1.496	1.157	1.071	.911	M4	.126
22	248-8520-000	248-8508-000	1.472	1.614	1.252	1.071	.911	M4	.126
24	248-8521-000	248-8509-000	1.610	1.752	1.374	1.071	.911	M4	.146
28	248-8522-000	248-8510-000	1.839	2.000	1.563	1.110	.951	M5	.146
32	248-8523-000	248-8511-000	2.102	2.244	1.752	1.110	.951	M5	.173
36	248-8524-000	248-8512-000	2.346	2.500	1.937	1.110	.951	M5	.173

Sealing Rings

For use on the barrel of the plug

Dimensions in mm

Size	Part No.	d ₉
10SL	980-8550-000	9,00
12S	980-8551-000	11,50
14S	980-8552-000	14,00
16/16S	980-8553-000	17,00
18	980-8554-000	19,50
20	980-8555-000	22,50
22	980-8556-000	25,40
24	980-8557-000	28,50
28	980-8558-000	34,00
32	980-8559-000	40,00
36	980-8560-000	45,00

Dimensions in inches

Size	Part No.	d ₉
10SL	980-8550-000	.354
12S	980-8551-000	.453
14S	980-8552-000	.551
16/16S	980-8553-000	.669
18	980-8554-000	.768
20	980-8555-000	.886
22	980-8556-000	1.000
24	980-8557-000	1.122
28	980-8558-000	1.339
32	980-8559-000	1.575
36	980-8560-000	1.772

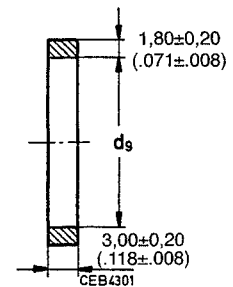

Wire Hole Fillers

Where contacts are not used, the contact cavities are to be closed by wire hole fillers.

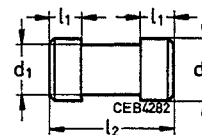

Dimensions in mm

Size	VG95234 Part No.	For Contact Size		d ₁ ±0,1	d ₂ ±0,2	l ₁ ±0,1	l ₂ ±0,3	Colour	Part No.
		Metr.	AWG						
20	VG95234B20	10		2,30	3,00	2,40	9,70	red	225-1000-000
16	VG95234B16	15S/15	16S/16	2,80	3,70	3,20	11,90	blue	225-0017-000
12	VG95234B12	25/25A	12	3,70	4,60	3,20	11,90	yellow	225-0018-000
8	VG95234B08	60/100	8	5,00	5,80	3,20	11,90	white	225-0019-000
4	VG95234B04	160	4	7,60	8,50	3,20	11,90	green	225-8502-000
0	VG95234B00	500	0	12,80	13,50	3,20	11,90	black	225-8503-000

Dimensions in inches

Size	VG95234 Part No.	For Contact Size		d ₁ ±.004	d ₂ ±.008	l ₁ ±.004	l ₂ ±.012	Colour	Part No.
		Metr.	AWG						
20	VG95234B20	10		.091	.118	.094	.382	red	225-1000-000
16	VG95234B16	15S/15	16S/16	.110	.146	.126	.469	blue	225-0017-000
12	VG95234B12	25/25A	12	.146	.181	.126	.469	yellow	225-0018-000
8	VG95234B08	60/100	8	.197	.228	.126	.469	white	225-0019-000
4	VG95234B04	160	4	.299	.335	.126	.469	green	225-8502-000
0	VG95234B00	500	0	.504	.531	.126	.469	black	225-8503-000

Cable Clamps

Without telescoping bushing

VG95234 Style KK

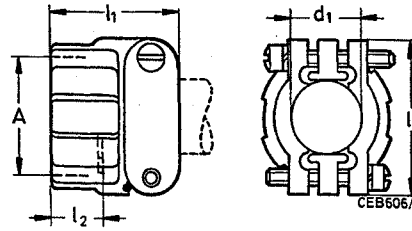

Dimensions in mm

VG95234 Part No.	Former Designation MS	Shell Size Suitable For Connectors Acc. MS	A-Thread	l ₂ max	d ₁ max	l ₁ max	l ₃ max	Shell-Weight g
VG95234KK4	MS3057-4A*	10SL, 12SL	5/7-24NEF-2B	10,50	7,90	20,80	22,50	13,20
VG95234KK6	MS3057-6A*	14S	3/4-20UNEF-2B	10,50	11,10	22,40	27,40	18,60
VG95234KK8	MS3057-8A*	16S, 16	7/8-20UNEF-2B	10,50	14,20	24,00	29,80	23,60
VG95234KK12	MS3057-10A*	18	1-20UNEF-2B	10,50	15,80	24,00	32,20	27,30
VG95234KK12	MS3057-12A*	20, 22	1-3/16-18NEF-2B	10,50	19,00	24,00	37,40	37,20
VG95234KK16	MS3057-16A*	24, 28	1-7/16-18NEF-2B	10,50	23,70	26,40	43,50	56,30
VG95234KK20	MS3057-20A*	32	1-3/4-18NS-2B	12,00	31,80	28,00	51,70	83,90
VG95234KK24	MS3057-24A*	36	2-18NS-2B	13,70	34,60	29,60	57,80	109,80

Dimensions in inches

VG95234 Part No.	Former Designation MS	Shell Size Suitable For Connectors Acc. MS	A-Thread	l ₂ max	d ₁ max	l ₁ max	l ₃ max	Shell-Weight g
VG95234KK4	MS3057-4A*	10SL, 12SL	5/7-24NEF-2B	.413	.311	.819	.886	13,20
VG95234KK6	MS3057-6A*	14S	3/4-20UNEF-2B	.413	.437	.882	1.079	18,60
VG95234KK8	MS3057-8A*	16S, 16	7/8-20UNEF-2B	.413	.559	.945	1.173	23,60
VG95234KK12	MS3057-10A*	18	1-20UNEF-2B	.413	.622	.945	1.268	27,30
VG95234KK12	MS3057-12A*	20, 22	1-3/16-18NEF-2B	.413	.748	.945	1.488	37,20
VG95234KK16	MS3057-16A*	24, 28	1-7/16-18NEF-2B	.413	.933	1.039	1.713	56,30
VG95234KK20	MS3057-20A*	32	1-3/4-18NS-2B	.472	1.252	1.102	2.035	83,90
VG95234KK24	MS3057-24A*	36	2-18NS-2B	.540	1.362	1.165	2.276	109,80

* WB = Cable clamp with cable telescoping bushing

Telescoping Bushings

Telescoping bushings (used with MS3057A resp. VG95234KK cable clamp) keep dirt, oil and dust out of endbell. Taping or wrapping wires is eliminated since bushing protects wires guided through clamp. Combinations of two bushings may be used to decrease inner diameter for improved sealing.

Material: Polychloroprene

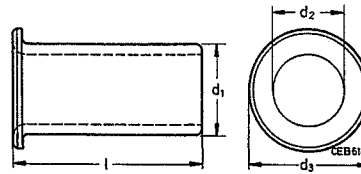

Dimensions in mm

Shell Size	VG95234 Part No.	MS Order No.	Cannon Part No.	d ₁	d ₂	d ₃	l	Weight
10SL, 12S	VG95234KT10SL	-	012-8552-000	8,00	6,60	9,90	70,00	4
14S	VG95234KT14S	-	012-8554-000	10,90	9,10	12,70	67,00	5
16S, 16	-	MS3420-08	012-0218-000	14,00	11,10	19,00	64,00	6
18	-	MS3420-10	012-0219-000	15,70	14,30	22,00	60,00	4
20,22	-	MS3420-12	012-0220-000	18,80	15,90	26,90	57,00	7
24	VG95234KT24	-	012-8555-000	21,20	16,60	26,90	57,00	13
28	VG95234KT28	-	012-8556-000	23,60	21,50	33,30	54,00	13
32	VG95234KT32	-	012-8557-000	26,50	21,50	33,30	54,00	26
	-	-	012-8558-000	31,50	26,80	40,40	51,00	26
36	VG95234KT32	-	012-8558-000	31,50	26,80	40,40	51,00	30
	-	MS3420-24	012-0223-000	34,70	31,80	46,80	48,00	30

Dimensions in inches

Shell Size	VG95234 Part No.	MS Order No.	Cannon Part No.	d ₁	d ₂	d ₃	l	Weight
10SL, 12S	VG95234KT10SL	-	012-8552-000	.315	.260	.390	2.756	4
14S	VG95234KT14S	-	012-8554-000	.429	.358	.500	2.638	5
16S, 16	-	MS3420-08	012-0218-000	.551	.437	.748	2.520	6
18	-	MS3420-10	012-0219-000	.618	.563	.866	2.362	4
20,22	-	MS3420-12	012-0220-000	.740	.626	1.059	2.244	7
24	VG95234KT24	-	012-8555-000	.835	.654	1.059	2.244	13
28	VG95234KT28	-	012-8556-000	.929	.846	1.311	2.126	13
32	VG95234KT32	-	012-8557-000	1.043	.846	1.311	2.126	26
	-	-	012-8558-000	1.240	1.055	1.591	2.008	26
36	VG95234KT32	-	012-8558-000	1.240	1.055	1.591	2.008	30
	-	MS3420-24	012-0223-000	1.366	1.252	1.843	1.890	30

Gaskets

Thickness of gaskets
 made of Alu-Flex "2" = 0,5 mm
 made of Polychloroprene "1" = 1,0 mm

VG95234 Style DA for front panel mounting
VG95234 Style DH for rear panel mounting

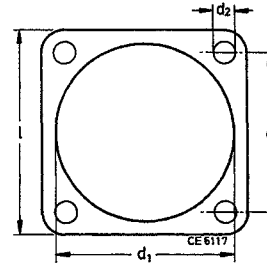

For Front Panel Mounting

Dimensions in mm

Size	VG95234 Part No.	Part No. Version Polychloroprene ¹	Part No. Version Alu-Flex ²	l ±0,50	e ±0,20	d ₁ +1	d ₂ +0,50	Weight g max
10SL	VG95234DA10SL-X	075-8512-000	075-8512-001	25,40	18,20	15,70	4,20	2
12S	VG95234DA12S-X	075-8513-000	075-8513-001	28,00	20,60	18,90	4,20	2
14S	VG95234DA14S-X	075-8514-000	075-8514-001	30,00	23,00	22,10	4,20	2
16/16S	VG95234DA16-X	075-8515-000	075-8515-001	32,50	24,60	25,30	4,20	2
18	VG95234DA18-X	075-8516-000	075-8516-001	35,00	27,00	28,40	4,20	2
20	VG95234DA20-X	075-8517-000	075-8517-001	38,00	29,40	31,60	4,20	2
22	VG95234DA22-X	075-8518-000	075-8518-001	41,00	31,80	34,80	4,20	2
24	VG95234DA24-X	075-8519-000	075-8519-001	44,50	34,90	38,00	4,20	2
28	VG95234DA28-X	075-8520-000	075-8520-001	50,80	39,70	44,30	5,10	2
32	VG95234DA32-X	075-8521-000	075-8521-001	57,00	44,50	50,70	5,10	2
36	VG95234DA36-X	075-8522-000	075-8522-001	63,50	49,20	57,00	5,10	2

For Front Panel Mounting

Dimensions in inches

Size	VG95234 Part No.	Part No. Version Polychloroprene ¹	Part No. Version Alu-Flex ²	l ±.020	e ±.008	d ₁ +.039	d ₂ +.020	Weight oz. max
10SL	VG95234DA10SL-X	075-8512-000	075-8512-001	1.000	.717	.618	.165	.086
12S	VG95234DA12S-X	075-8513-000	075-8513-001	1.102	.811	.744	.165	.086
14S	VG95234DA14S-X	075-8514-000	075-8514-001	1.181	.906	.870	.165	.086
16/16S	VG95234DA16-X	075-8515-000	075-8515-001	1.280	.969	.996	.165	.086
18	VG95234DA18-X	075-8516-000	075-8516-001	1.378	1.063	1.118	.165	.086
20	VG95234DA20-X	075-8517-000	075-8517-001	1.496	1.157	1.244	.165	.086
22	VG95234DA22-X	075-8518-000	075-8518-001	1.614	1.252	1.370	.165	.086
24	VG95234DA24-X	075-8519-000	075-8519-001	1.752	1.374	1.496	.165	.086
28	VG95234DA28-X	075-8520-000	075-8520-001	2.000	1.563	1.744	.201	.086
32	VG95234DA32-X	075-8521-000	075-8521-001	2.244	1.752	1.996	.201	.086
36	VG95234DA36-X	075-8522-000	075-8522-001	2.500	1.937	2.244	.201	.086

X = insert "1" (electrically not conductive) or "2" (electrically conductive)

For Rear Panel Mounting

Dimensions in mm

Size	VG95234 Part No.	Part No. Version Polychloroprene ¹	Part No. Version Alu-Flex ²	l ±0,50	e ±0,20	d ₁ +1,00	d ₂ +0,50	Weight g max
10SL	VG95234DH10SL-X	075-8501-000	075-8501-001	25,40	18,20	18,20	4,20	2
12S	VG95234DH120S-X	075-8502-000	075-8502-001	28,00	20,60	21,40	4,20	2
14S	VG95234DH14S-X	075-8503-000	075-8503-001	30,00	23,00	24,60	4,20	2
16/16S	VG95234DH16-X	075-8504-000	075-8504-001	32,50	24,60	27,40	4,20	2
18	VG95234DH18-X	075-8505-000	075-8505-001	35,00	27,00	30,80	4,20	2
20	VG95234DH20-X	075-8506-000	075-8506-001	38,00	29,40	34,20	4,20	2
22	VG95234DH22-X	075-8507-000	075-8507-001	41,00	31,80	37,40	4,20	2
24	VG95234DH24-X	075-8508-000	075-8508-001	44,50	34,90	40,90	4,20	2
28	VG95234DH28-X	075-8509-000	075-8509-001	50,80	39,70	46,70	5,10	2
32	VG95234DH32-X	075-8510-000	075-8510-001	57,00	44,50	53,40	5,10	2
36	VG95234DH36-X	075-8511-000	075-8511-001	63,50	49,20	59,60	5,10	2

For Rear Panel Mounting

Dimensions in inches

Size	VG95234 Part No.	Part No. Version Polychloroprene ¹	Part No. Version Alu-Flex ²	l ±.020	e ±.008	d ₁ +.039	d ₂ +.020	Weight oz. max
10SL	VG95234DH10SL-X	075-8501-000	075-8501-001	1.000	.717	.717	.165	.086
12S	VG95234DH120S-X	075-8502-000	075-8502-001	1.102	.811	.842	.165	.086
14S	VG95234DH14S-X	075-8503-000	075-8503-001	1.181	.906	.969	.165	.086
16/16S	VG95234DH16-X	075-8504-000	075-8504-001	1.280	.969	1.079	.165	.086
18	VG95234DH18-X	075-8505-000	075-8505-001	1.378	1.063	1.212	.165	.086
20	VG95234DH20-X	075-8506-000	075-8506-001	1.496	1.157	1.346	.165	.086
22	VG95234DH22-X	075-8507-000	075-8507-001	1.614	1.252	1.472	.165	.086
24	VG95234DH24-X	075-8508-000	075-8508-001	1.752	1.374	1.610	.165	.086
28	VG95234DH28-X	075-8509-000	075-8509-001	2.000	1.563	1.838	.201	.086
32	VG95234DH32-X	075-8510-000	075-8510-001	2.244	1.752	2.102	.201	.086
36	VG95234DH36-X	075-8511-000	075-8511-001	2.500	1.937	2.346	.201	.086

X = insert "1" (electrically not conductive) or "2" (electrically conductive)

Pin Contacts

Standard contacts and contacts with reduced termination diameter

Finish

A36 – 5 μm Silver Plated and Passivated
A176 – 2 μm Nickel Plated, min 0,5 μm Gold Plated

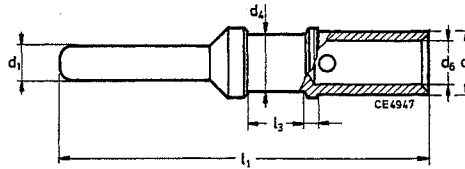

Size 15S/16S, 15/16, 25/12, 60/100/8, 160/4, 500/0

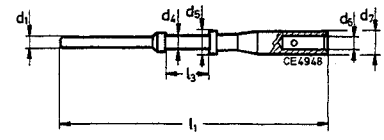

Size 10/20

Note: When ordering contacts separately from the connector, the modification code -F0 should be added to the connector part number (see page 10).

Dimensions in mm (inches)

Contact Size	VG95234 Part Number	Wire Size mm ²	AWG	Part Number With Finish Standard: A36 Silver Plated	Part Number With Finish Mod. Code: A176 Gold Plated	d ₁ -0,05 (-.002)	d ₄	d ₅	d ₇	l ₁ ±0,15 (±.006)	l ₃ ±0,50 (±.020)
10/20	VG95234P10	0,50-1,00	20/18	030-8585-000	030-8585-006	1,04 (.041)	1,50 ^{-0,05} (.059 ^{-0,02})	1,50 ^{+0,05} (.059 ^{+0,02})	2,40 ^{-0,05} (.094 ^{-0,02})	28,40 1.118	4,75 (.187)
		0,20-0,40	24/22	030-8585-010	-	1,04 (.041)	1,50 ^{-0,05} (.059 ^{-0,02})	0,90 ^{+0,05} (.035 ^{+0,02})	2,40 ^{-0,05} (.094 ^{-0,02})	28,40 1.118	4,75 (.187)
15S/16S	VG95234P15S	0,75-1,50	18/16	030-8586-000	030-8586-006	1,60 (.063)	1,75 ^{-0,1} (.069 ^{-0,04})	1,75 ^{+0,08} (.069 ^{+0,03})	2,75 ^{-0,05} (.108 ^{-0,02})	27,40 1.179	3,85 (.152)
		0,30-0,60	22/20	330-8744-000	330-8744-006	1,60 (.063)	1,75 ^{-0,1} (.069 ^{-0,04})	1,20 ^{+0,1} (.047 ^{+0,04})	2,75 ^{-0,05} (.108 ^{-0,02})	27,40 1.179	3,85 (.152)
		0,14-0,38	22/26	030-8586-010	-	1,60 (.063)	1,75 ^{-0,1} (.069 ^{-0,04})	0,90 ^{+0,05} (.035 ^{+0,02})	2,75 ^{-0,05} (.108 ^{-0,02})	27,40 1.179	3,85 (.152)
15/16	VG95234P15	0,75-1,50	18/16	030-8587-000	030-8587-006	1,60 (.063)	1,75 ^{-0,1} (.069 ^{-0,04})	1,75 ^{+0,08} (.069 ^{+0,03})	2,75 ^{-0,05} (.108 ^{-0,02})	31,40 1.236	7,90 (.311)
		0,30-0,60	22/20	330-8659-000	330-8659-006	1,60 (.063)	1,75 ^{-0,1} (.069 ^{-0,04})	1,20 ^{+0,1} (.047 ^{+0,04})	2,75 ^{-0,05} (.108 ^{-0,02})	31,40 1.236	7,90 (.311)
		0,14-0,38	22/26	030-8587-030	030-8587-036	1,60 (.063)	1,75 ^{-0,1} (.069 ^{-0,04})	0,90 ^{+0,05} (.035 ^{+0,02})	2,75 ^{-0,05} (.108 ^{-0,02})	31,40 1.236	7,90 (.311)
25/12	VG95234P25	2,00-3,00	14/12	030-8588-000	030-8588-006	2,40 (.094)	3,30 ^{-0,15} (.130 ^{-0,06})	2,50 ^{+0,1} (.098 ^{+0,04})	3,80 ^{-0,1} (.150 ^{-0,04})	37,00 1.457	7,90 (.311)
		0,75-1,50	18/16	030-8588-010	030-8588-016	2,40 (.094)	3,30 ^{-0,15} (.130 ^{-0,06})	1,75 ^{+0,08} (.069 ^{+0,03})	3,80 ^{-0,1} (.150 ^{-0,04})	37,00 1.457	7,90 (.311)
		4,00	-	030-8588-054	-	2,40 (.094)	3,30 ^{-0,15} (.130 ^{-0,06})	2,80 ^{+0,1} (.110 ^{+0,04})	3,80 ^{-0,1} (.150 ^{-0,04})	37,00 1.457	7,90 (.311)
60/100/8	VG95234P60	-	8	030-8612-000	030-8612-006	3,60 (.142)	6,25 ^{-0,15} (.246 ^{-0,06})	4,55 ^{+0,1} (.179 ^{+0,04})	6,80 ^{-0,1} (.268 ^{-0,04})	39,60 1.559	6,35 (.250)
		6,00	10	030-8589-000	030-8589-006	3,60 (.142)	6,25 ^{-0,15} (.246 ^{-0,06})	3,50 ^{+0,1} (.138 ^{+0,04})	6,80 ^{-0,1} (.268 ^{-0,04})	39,60 1.559	6,35 (.250)
		10,00	-	030-8590-000	030-8590-006	3,60 (.142)	6,25 ^{-0,15} (.246 ^{-0,06})	4,80 ^{+0,1} (.189 ^{+0,04})	6,80 ^{-0,1} (.268 ^{-0,04})	39,60 1.559	6,35 (.250)
		2,00-3,00	14/12	030-8612-010	-	3,60 (.142)	6,25 ^{-0,15} (.246 ^{-0,06})	2,50 ^{+0,05} (.098 ^{+0,02})	6,80 ^{-0,1} (.268 ^{-0,04})	39,60 1.559	6,35 (.250)
		4,00	-	030-8612-020	-	3,60 (.142)	6,25 ^{-0,15} (.246 ^{-0,06})	2,80 ^{+0,1} (.110 ^{+0,04})	6,80 ^{-0,1} (.268 ^{-0,04})	39,60 1.559	6,35 (.250)
160/4	VG95234P160	-	4	030-8613-000	030-8613-006	5,75 (.226)	9,55 ^{-0,15} (.376 ^{-0,06})	7,10 ^{+0,15} (.280 ^{+0,06})	9,55 ^{-0,1} (.376 ^{-0,04})	39,60 1.559	6,35 (.250)
		16,00	-	030-8591-000	030-8591-006	5,75 (.226)	9,55 ^{-0,15} (.376 ^{-0,06})	6,20 ^{+0,15} (.244 ^{+0,06})	9,55 ^{-0,1} (.376 ^{-0,04})	39,60 1.559	6,35 (.250)
		10,00	-	030-8591-020	-	5,75 (.226)	9,55 ^{-0,15} (.376 ^{-0,06})	4,80 ^{+0,1} (.189 ^{+0,04})	9,55 ^{-0,1} (.376 ^{-0,04})	39,60 1.559	6,35 (.250)
500/0	VG95234P500	-	0	030-8614-000	030-8614-006	9,10 (.358)	13,55 ^{-0,15} (.533 ^{-0,06})	11,50 ^{+0,15} (.453 ^{+0,06})	14,35 ^{-0,1} (.565 ^{-0,04})	41,00 1.614	6,35 (.250)
		50,00	-	030-8592-000	030-8592-006	9,10 (.358)	13,55 ^{-0,15} (.533 ^{-0,06})	10,70 ^{+0,15} (.421 ^{+0,06})	14,35 ^{-0,1} (.565 ^{-0,04})	41,00 1.614	6,35 (.250)
		25,00	4	030-8614-010	-	9,10 (.358)	13,55 ^{-0,15} (.533 ^{-0,06})	7,60 ^{+0,15} (.299 ^{+0,06})	14,35 ^{-0,1} (.565 ^{-0,04})	41,00 1.614	6,35 (.250)
		35,00	2	030-8614-020	-	9,10 (.358)	13,55 ^{-0,15} (.533 ^{-0,06})	9,10 ^{+0,15} (.358 ^{+0,06})	14,35 ^{-0,1} (.565 ^{-0,04})	41,00 1.614	6,35 (.250)
		16,00	-	030-8614-030	-	9,10 (.358)	13,55 ^{-0,15} (.533 ^{-0,06})	6,20 ^{+0,15} (.244 ^{+0,06})	14,35 ^{-0,1} (.565 ^{-0,04})	41,00 1.614	6,35 (.250)

X-ON Electronics

Largest Supplier of Electrical and Electronic Components

Click to view similar products for [Headers & Wire Housings](#) category:

Click to view products by [ITT](#) manufacturer:

Other Similar products are found below :

[95000-104TRLF](#) [10135584-644402LF](#) [DF62W-EP2022PCA](#) [95000-106TRLF](#) [DF62W-2022SCA](#) [DF62W-EP2022PC](#) [2203348](#) [DF62W-2022SC](#) [1084018](#) [1029039](#) [1084017](#) [802-10-012-10-002000](#) [1112640](#) [1112639](#) [000-34000](#) [0009482033](#) [0009507031](#) [57102-S06-03LF](#) [57202-S52-04LF](#) [PCN6-15S-2.5E](#) [0039019024](#) [58102-G61-06LF](#) [582553-1](#) [0009485154](#) [0009508121](#) [0022285053](#) [0050291907](#) [018731A](#) [LY20-4P-DT1-P1E-BR](#) [02.125.8002.8](#) [60101931](#) [60598-1 \(Cut Strip\)](#) [M1625-3R/100](#) [61062-3](#) [61082-181009](#) [636-1427](#) [638009-1](#) [641938-9](#) [641991-4](#) [644168-1](#) [647662-1](#) [65039-019ELF](#) [65781-047](#) [65817-002LF](#) [65817-015LF](#) [65863-015LF](#) [66207-023LF](#) [67016-026LF](#) [67046-001LF](#) [67095-007LF](#)