



Connector Product Locations

With manufacturing facilities, sales representatives and distributors located worldwide, please visit our website at [www.ittcannon.com](http://www.ittcannon.com) for a complete listing and to find the office nearest you.

**GERMANY**

Cannonstrasse 1  
Weinstadt, 71384  
phone: 49.7151.699.0  
fax: 49.7151.699.217

**HONG KONG**

Unit 901 & 912, West Tower  
Shun Tak Center  
168-200 Connaught Road  
Central  
phone: 852.2732.2720  
fax: 852.2732.2919

**ITALY**

Via Pietro Panzeri 10  
Milano, 20123  
phone: 39.2.58180.1  
fax: 39.2.8372036

**UK**

Jays Close, Viabes Estate  
Basingstoke, RG22 4BA  
phone: 44.1256.311200  
fax: 44.1256.323356

**USA**

666 East Dyer Road  
Santa Ana, CA 92705  
toll free: 1.800.854.3028  
phone: 1.714.557.4700  
fax: 1.714.628.2142

Cannon  
CA-Bayonet  
Connectors  
In Accordance with VG95234



"Engineered for life" is a registered trademark of ITT Industries. ©2005. All other trademarks or registered trademarks are property of their respective owners. All data subject to change without notice.

## Interconnect Technologies & Solutions

For over 90 years, ITT has been developing innovative solutions for harsh environment applications. We have a proven track record of demonstrating our expertise and commitment to the industrial industry, offering the broadest portfolio of interconnect products.

Our interconnect range include sealed circulars, plastic and metal shell bayonet coupling circulars, miniature metal shell circulars, PC board header connectors and sensor and direct device connectors. ITT is also a systems supplier, providing value-added module and harness assemblies.

In addition to our CA Bayonet series, we also offer these connectivity solutions:

### Environmentally Sealed



#### Cannon MIL-DTL-38999

High density contact arrangements, corrosion-resistant shells, rear release crimp snap-in contacts, operates under severe high temperature vibration testing.



#### Cannon Trident

Versatile range of electrical connectors based on a standard contact design. Options include; industrial grade, harsh environment and shielded circulars.

ITT logo blocks and the composite ITT logo are registered trademark of ITT Industries. ©2005

### Harsh Environments



#### Cannon KPT / KPSE

Environmentally sealed miniature circular connectors available in two versions: KPT (solder contact) and KPSE (high performance crimp contact). Intermateable and intermountable with all MIL-C-26482 connectors and is available with many materials, finishes and configurations.

#### Table of Contents

|                            |      |
|----------------------------|------|
| Introduction               | .3   |
| Technical Data             | .4-5 |
| Mounting Dimensions        | .6-7 |
| How to Order               | .8   |
| Contact Arrangements       | .10  |
| Connector Dimensions       | .28  |
| Coupling Dimensions        | .43  |
| Accessories                | .44  |
| Contacts                   | .50  |
| Product Safety Information | .54  |

## Introduction

Cannon CA-Bayonet series was designed in accordance with the VG95234 specification. This versatile and highly reliable connector series is an improvement on the well established MIL-C-5015 series. CA-Bayonet has a proven bayonet coupling design that offers exceptional vibration protected sealing against fluids, and easy connection/disconnection.

Initially designed for aircraft and airborne applications, these rugged connectors are used in the electrical equipment of trucks, off-road vehicles, ships, earth-moving equipment, telecommunications and others.

Connectors in accordance with VG95234 are interchangeable with the corresponding MIL-C-5015 connectors. Both connector lines feature the same shell dimensions and contacts layouts. However, due to the different coupling systems (MIL-C-5015 threaded coupling, VG95234 bayonet coupling) they are not intermateable.

## Advantages

- rugged shell design
- environmental
- bayonet coupling for easy mating and unmating
- vibration proof
- waterproof up to 1 bar (35 feet of water)

Cannon has the complete VG95234 program available and, in addition, many other types which exceed the requirements of VG95234 and MIL-C-5015.

### Attention:

Metal shell connectors which may be touched are not suitable for mains power. See page 54 for Product Safety Information, para. 5.

\* European Community "Old Car" directive (2000/53/EG)

\* European Community Waste Electrical and Electronic Equipment (WEEE) 2000/0158

\* European Community restrictions of use of certain hazardous substances in WEEE (ROS) (2000/0159)

## Connector Design

Due to the rugged shell made of an aluminium alloy, these connectors withstand most severe conditions. Olive drab chromate coating over cadmium plating protects the surface of the shell.

Cannon offers zinc cobalt plating as an alternative to customers who refuse cadmium plating and also as a general improvement of the zinc plating.

The insulators are made of high quality polychloroprene and withstand temperatures from  $-67^{\circ}/+257^{\circ}\text{F}$  ( $-55/125^{\circ}\text{C}$ ). This material is self-extinguishing, resistant against hydraulic fluids, jet fuel, diesel fuel, gasolines, lubricants, brake and fire extinguisher fluids.

The contacts are made of copper alloy plated with a hard silver finish guarantee at least 500 mating cycles.

All solder contacts feature a special passivation to comply with ROHS requirements. The crimp contacts allow highly reliable crimping with wires according to TL 6145-009, TL 6145-011 and MIL-W-5086 when using the recommended tools according to VG95234. Crimp contacts can be exchanged at least five times due to the contact retention.

The insulators are made of high quality polychloroprene and withstand temperatures from  $-67^{\circ}/+257^{\circ}\text{F}$  ( $-55/125^{\circ}\text{C}$ ). This material is self-extinguishing, resistant against hydraulic fluids, The bayonet design allows fast and easy coupling and uncoupling. An audible control by metallic sound and visual control by colour-marked snap-in position offer additional coupling security.

VG connectors are basically designed for single wire harnessing. For full environmental sealing each conductor is sealed completely within the grommet. Under certain conditions, jacketed cables can be used for the shell styles E, G, M and N.



## Electrical Data

Contact rating at 68 °F (+20 °C)

| Contact size | max. current<br>A |
|--------------|-------------------|
| 10           | 8                 |
| 16S/15S      | 22                |
| 16/15        | 22                |
| 12/25        | 41                |
| 8/60/100     | 74                |
| 4/160        | 135               |
| 0/500        | 245               |

Current rating  
depending on ambient temperature



### Operating voltage and connector usage

Connectors in equipments must not be separated or mated under load when used per specifications.

As according to specification the connectors are suitable for an operating voltage of 50 V (see Product Safety Information). However, this is only valid, when the connectors are freely accessible during operation and consequently might be touchable. When the connectors will be operated with line voltage, please contact ITT Customer Service.

Contact resistance  
(Millivolt test)

The contact resistance has to be tested according to VG95234 part 2, test no. 5.10.1 and VG 95210, part 37. The measuring points are indicated in the illustration.



| Contact size |        | Max. contact<br>resistance<br>mΩ |
|--------------|--------|----------------------------------|
| metric       | AWG    |                                  |
| 10           | -      | 12                               |
| 15S/15       | 16S/16 | 6                                |
| 25           | 12     | 3                                |
| 60/100       | 8      | 1                                |
| 160          | 4      | 0,5                              |
| 500          | 0      | 0,2                              |

Insulation resistance

Acc. to VG95319, part 2, test no. 5.12 and VG95210, part 32, test condition B  
Standard insulator material > 1000 MΩ  
FKM insulator material (upon request) > 5000 MΩ

Test voltage

Acc. to VG95319, part 2, test no. 5.13 and VG 95210, part 31  
Test voltage for service rating:

| Service rating | Test voltage $V_{rms}$ |
|----------------|------------------------|
| Instruments    | 1050                   |
| A              | 1600                   |
| B              | 4000                   |
| D              | 2500                   |
| E              | 3000                   |

Air and creepage paths (min.)

| Voltage class             | Instr. | A   | D   | E   |
|---------------------------|--------|-----|-----|-----|
| Air and creepage paths mm | 0,7    | 1,1 | 2,8 | 4,8 |

## Mechanical Features

**Ambient temperature**  
Standard insulator material  
-55°/125°C (- 67/257°F)

FKM insulator material\*  
-30°/200°C (- 22/392°F)

**Safety provisions\*\***  
IP 67 acc. to DIN 40 050  
(1 bar pressure after 12 hrs.)

**Vibration test**  
200 m/s<sup>2</sup> at 10 to 2000 Hz

**Mating cycles**  
500 min.

**Separating force per contact.**  
The corresponding separating force has to be measured according to VG95319, part 2, test no. 5.7. using the required test gage.

| Contact size metric | AWG    | Separating force min. |        |
|---------------------|--------|-----------------------|--------|
|                     |        | N                     | Gage   |
| 10                  | -      | 0,3                   | G 0,99 |
| 15S/15              | 16S/16 | 1,0                   | G 1,56 |
| 25                  | 12     | 1,5                   | G 2,36 |
| 60/100              | 8      | 3,0                   | G 3,58 |
| 160                 | 4      | 4,0                   | G 5,69 |
| 500                 | 0      | 8,5                   | G 9,04 |

**Gage**  
(see also VG 95234, Part 1)



| Gage   | Contact diameter d +0,01 | L  |
|--------|--------------------------|----|
| G 0,99 | 0,99                     | 7  |
| G 1,56 | 1,56                     | 9  |
| G 2,36 | 2,36                     | 12 |
| G 3,58 | 3,58                     | 13 |
| G 5,69 | 5,69                     | 13 |
| G 9,04 | 9,04                     | 13 |

## Coupling torque

The allowable coupling torques have to be tested under full bundle conditions of the connectors to VG95319, part 2, test no. 5.8.2.

| Shell size | Allowable coupling torque closing and opening Nm max. | Opening Nm min. |
|------------|---|-----------------|
| 10SL       | 1,7   | 0,15            |
| 12S        | 2,5   | 0,23            |
| 14S        | 3,6   | 0,35            |
| 16S/16     | 5,5   | 0,46            |
| 18         | 8   | 0,58            |
| 20         | 9   | 0,7             |
| 22         | 11  | 0,8             |
| 24         | 14  | 0,8             |
| 28         | 17  | 0,92            |
| 32         | 19  | 1,03            |
| 36         | 23  | 1,03            |

## Contact retention

The contact retention has to be tested according to VG95319, part 2, test no. 5.4. Test force direction = Mating direction.

| Contact size | AWG    | Test force N |
|--------------|--------|--------------|
| 10           | -      | 30           |
| 15S/15       | 16S/16 | 35           |
| 25           | 12     | 55           |
| 60/100       | 8      | 80           |
| 160          | 4      | 90           |
| 500          | 0      | 95           |

## Materials

**Shell**  
Standard finish  
Aluminum alloy  
Olive drab chromate coating over cadmium plating

Alternative finish  
Zinc cobalt (see page 9 - Modification)

**Insulator and grommets**  
Polychloroprene (Standard)  
FKM (High temperature)\*

**Contacts**  
Standard finish  
Copper alloy  
Hard silver  
Special finish  
A176 nickel and hard gold plating

\* upon request

\*\* **Longitudinal sealing:** The connector is not sealed against fluids entering through the cable, as the sealing lips of the single wire sealing are pressing against the jacket of the individual cables.

# Cannon VG/CA-Bayonet

## Mounting Holes

Mounting holes for wall mounting receptacles style A, B1, B2, C1, C2, J1, J2, N1 and N2 acc. to VG95234, or CA 3100E/F/R-B and CA 3102 E-B.



| Shell size | ø d1H12<br>Style A<br>CA 3102E-B | Style B1, B2<br>C1, C2, J1, J2<br>N1, N2<br>CA 3100E, F, R-B<br>TBF-B/-05 | ø d2H13<br>Style<br>A, B2, C2,<br>J2, N2<br>CA-B<br>Mod-05 | Style<br>B1, C1, J1, N1<br><br>CA 3100E, F, R-B | e<br>±0,15 | screws to be used<br>A, B2, C2, J2,<br>N2<br><br>CA-B-Mod. 05 | B1, C1, J1, N<br>CA 3100E, F |
|------------|----------------------------------|---|--|---|------------|---|------------------------------|
| 10SL       | 16,4                             | 18,5  | 3,4  | 4,5   | 18,2       | M3...DIN 85   | M4...DIN 84                  |
| 12S        | 16,4                             | 21,7  | 3,4  | 4,5   | 20,6       | M3...DIN 85   | M4...DIN 84                  |
| 14S        | 19,7                             | 24,9  | 3,4  | 4,5   | 23,0       | M3...DIN 85   | M4...DIN 84                  |
| 16S        | 22,9                             | 27,7  | 3,4  | 4,5   | 24,6       | M3...DIN 85   | M4...DIN 84                  |
| 16         | 22,9                             | 27,7  | 3,4  | 4,5   | 24,6       | M3...DIN 85   | M4...DIN 84                  |
| 18         | 26,1                             | 31,1  | 3,4  | 4,5   | 27,0       | M3...DIN 85   | M4...DIN 84                  |
| 20         | 29,5                             | 34,5  | 3,4  | 4,5   | 29,4       | M3...DIN 85   | M4...DIN 84                  |
| 22         | 32,7                             | 37,8  | 3,4  | 4,5   | 31,8       | M3...DIN 85   | M4...DIN 84                  |
| 24         | 36,0                             | 41,3  | 3,9  | 4,5   | 34,9       | M3,5...DIN 85   | M4...DIN 84                  |
| 28         | 42,0                             | 47,1  | 3,9  | 5,5   | 39,7       | M3,5...DIN 85   | M5...DIN 84                  |
| 32         | 48,3                             | 53,8  | 4,5  | 5,5   | 44,5       | M4...DIN 85   | M5...DIN 84                  |
| 36         | 54,6                             | 60,0  | 4,5  | 5,5   | 49,2       | M4...DIN 85   | M5...DIN 84                  |

\* When used with safety elements the max. outer diameter must not exceed the outer diameter of the screw head.

## Harnessing

VG95234 connectors are designed for single wire harnessing. Full sealing will be guaranteed only by using wires in accordance with MIL-W-5086, LN 9251 (for AWG) and TL 6145-009 and TL 6145-011 (for metric wires). All other wires have to conform to wire and insulation diameters with the data given in the following table:

| Contact size<br>AWG | Crimp- and solder contacts |                        | Insulation Ø |              |           |
|---------------------|----------------------------|------------------------|--------------|--------------|-----------|
|                     | metric<br>mm               | AWG<br>mm <sup>2</sup> | AWG          | metric<br>mm |           |
| -                   | 10                         | -                      | 0,75-1,0     | -            | 1,45-2,5  |
| 16S/15S             | 16/15                      | 16                     | 0,75-1,5     | 1,6-2,8      | 1,60-2,8  |
| 12                  | 25                         | 12                     | 2,5          | 2,9-3,5      | 2,9-3,5   |
| -                   | 60                         | -                      | 6,0          | -            | 3,5-4,9   |
| 8                   | 100                        | 8                      | 10,0         | 4,2-5,8      | 5,5-6,5   |
| 4                   | 160                        | 4                      | 16,0         | 6,2-9,0      | 7,1-9,0   |
| 0                   | 500                        | 0                      | 50,0         | 10,5-13,0    | 10,5-13,0 |

## Wire Stripping

Either mechanical or hot stripping can be used. Prevent conductor or insulator damage. For solder contacts, conductors have to be pretinned.

Note: Do not twist conductors used with crimp contacts. Do not touch uninsulated conductors before crimping. Twisting of conductors and grease or lubricants on the wires cause poor crimp quality.

| Contact size<br>AWG | metric | Stripping length<br>mm |
|---------------------|--------|------------------------|
| -                   | 10     | 4,0 + 0,4              |
| 16S/15S             | 16/15  | 6,0 + 0,5              |
| 12                  | 25     | 6,0 + 0,5              |
| 8                   | 60/100 | 11,0 + 0,8 - 0,4       |
| 4                   | 160    | 11,0 + 0,8 - 0,4       |
| 0                   | 500    | 13,0 + 0,8 - 0,4       |

Separating and Mounting Dimensions

When using connectors according to VG 95234 the below mentioned installation dimensions have to be met.

Connector style D  
or  
CA3106E-B and  
CA3106F-B  
CA3106F-B-13/-14/-15



Connector style G, M, R1  
or  
CA3106E-B-02/-03/-06  
CA3106E-B-13/-14/-15 and  
CA3106E-B-32  
with shrink boot, straight,  
acc. VG95343

Connector style E, E1 and K  
or  
CA3108E/F-B and  
CA3108F-B-13/-14/-15



Connector style G, M, R1  
or  
CA3106E-B-02/-03/-06  
CA3106E-B-32  
with shrink boot 90°  
acc. to VG 95343

| Shell Size | L1 (D) min. | L2 (G/M) min. | L3 min. | L4         |           | L5 max. | L6 max. |
|------------|-------------|---------------|---------|------------|-----------|---------|---------|
|            |             |               |         | (G/M) min. | R1 +10 mm |         |         |
| 10SL       | 70          | 70            | 70      | 65         | 75        | 8,0     | 3,5     |
| 12S        | 70          | 75            | 75      | 70         | 80        | 8,0     | 3,5     |
| 14S        | 70          | 75            | 75      | 70         | 80        | 8,0     | 3,5     |
| 16S        | 70          | 90            | 80      | 80         | 90        | 8,0     | 3,5     |
| 16         | 80          | 100           | 90      | 90         | 100       | 6,5     | 3,5     |
| 18         | 90          | 100           | 90      | 90         | 100       | 8,0     | 3,5     |
| 20         | 90          | 100           | 95      | 100        | 110       | 8,0     | 3,5     |
| 22         | 90          | 100           | 95      | 100        | 110       | 8,0     | 3,5     |
| 24         | 110         | 120           | 105     | 110        | 120       | 8,0     | 5,0     |
| 28         | 110         | 120           | 105     | 110        | 120       | 9,0     | 5,0     |
| 32         | 110         | 180           | 115     | 120        | 130       | 9,0     | 6,0     |
| 36         | 110         | 190           | 120     | 130        | 140       | 9,0     | 6,0     |

Dimensions shown in mm  
Specifications and dimensions subject to change

# Cannon VG/CA-Bayonet

## How to order

VG Order reference



## Explanation

|                     |   |
|---------------------|---|
| Series              | VG 95234  |
| Shell style         | J1, J2, N1, N2, S1, U1, U2 – wall mounting receptacle<br>F – cable connection plug<br>A, B1, B2 – box mounting receptacle<br>C1, C2 – bulkhead receptacle<br>D, G, H, L, M, R1 – straight plug<br>E, E1, K – plug 90° |
| Shell size          | 10SL, 14S, 16S, 16, 18, 20, 22, 24, 28, 32 and 36   |
| Contact arrangement | see page 10   |
| Contact type        | P – Pin contact<br>S – Socket contact   |
| Contact termination | without identification – contacts for metric wire sizes<br>identification 1* – contact for AWG wire sizes   |
| Insulator position  | see page 24   |

## Accessories acc. to VG

|                      |             |
|----------------------|-------------|
| Dummy receptacles    | VG95234 BOD |
| Gaskets, front mount | VG95234 DA  |
| Gaskets, rear mount  | VG95234 DH  |
| Protecting caps      | VG95234 KR  |
| Protecting caps      | VG95234 KB  |
| Cabel caps           | VG95234 KK  |
| Bushing              | VG95234 KT  |

\* Only valid for layout within the VG95234.

Layout list permitting identification 1:

| Layout | Page Number |
|--------|-------------|
| 22-2   | 15          |
| 24- 11 | 16          |
| 24-12  | 17          |
| 28-22  | 19          |
| 32-1   | 19          |
| 32-6   | 20          |
| 36-3   | 21          |
| 36-5   | 21          |
| 36-6   | 21          |



## How to order

Cannon Order reference

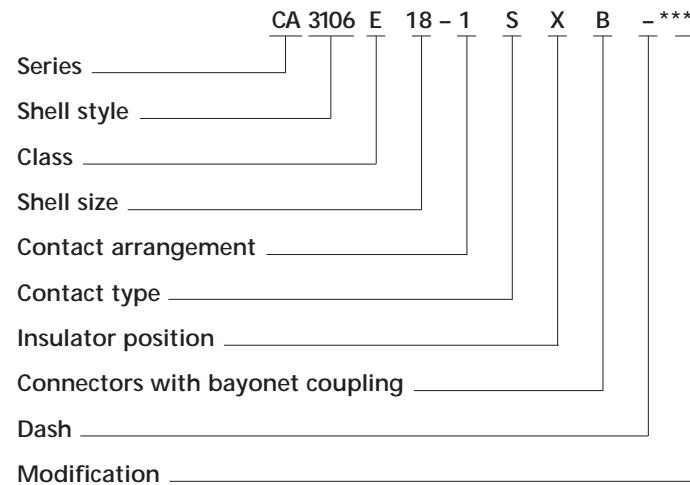

## Explanation

|                     |   |
|---------------------|---|
| Series              | CA – Circular connectors with bayonet coupling  |
| Shell style         | 3100 – Wall mounting receptacle<br>3101 – Cable connecting plug<br>3102 – Box mounting receptacle<br>3105 – Dummy receptacle for front and panel mounting<br>3106 – Plug, straight<br>3108 – Plug, 90°<br>TBF – Bulkhead receptacle   |
| Class               | E – environmental with resilient insulators and endbell with clamp and bushing<br>F – environmental with resilient insulator and endbell for flex tube<br>R – environmental with resilient insulator and shortened light-weight endbell without cable clamp   |
| Shell size          | 10SL, 12S, 14S, 16S, 16, 18, 20, 22, 24, 28, 32 and 36  |
| Contact arrangement | see page 10   |
| Contact type        | P – Pin<br>S – Socket<br>PS – one side pin, one side socket (only for TBF)  |
| Insulator position  | Besides the normal position further insulator positions are possible for Cannon connectors (see page 24) to prevent mismatching. Polarization is achieved by turning the pin contact insulator clockwise towards the shell, the socket insulator, however, in opposite clockwise direction. This information refers to the mating side of the contact insulator. For special insert alternations of standard inserts see page 25. |
| Modification        | see next page   |

Dimensions shown in mm  
Specifications and dimensions subject to change

www.ittcannon.com



|                      |      |  |
|----------------------|------|--|
| <b>Modification</b>  | 01   | – metric crimp contacts  |
| (only for CA.....-B) | 02   | – adapter for heat shrink boots<br>AWG crimp contacts                      |
|                      | 03   | – adapter for heat shrink boots,<br>metric contacts                        |
|                      | 04   | – rear mount, thread in flange,<br>metric crimp contacts                   |
|                      | 05   | – rear mount, through holes in flange,<br>(CA3100, CA 3102,<br>CA 20, TBF) |
|                      | 06   | – shrink boot adapter, thread holes<br>in flange, solder pot contacts      |
|                      | 08   | – angular endbell, through holes in<br>flange (for CA3100 only)            |
|                      | 09   | – angular endbell, through holes in<br>flange (for CA3100 only)            |
|                      | 13   | – shielded version, solder contacts  |
|                      | 14   | – shielded version, metric crimp con-<br>tacts                             |
|                      | 15   | – shielded version, AWG crimp contacts                                     |
|                      | 41   | – shielded version, heat shrink boot<br>adapter                            |
|                      | 32   | – endbell for shielded system cable acc.<br>MTV 6145-005                   |
|                      | 109  | – F80, rear mount, thread holes in<br>flange (for CA3100 only)             |
|                      | 111  | – rear mount, thread holes (CA3102<br>only), solder contacts               |
|                      | F80  | – AWG crimp contacts   |
|                      | A232 | – Zinc cobalt black  |
|                      | A233 | – Zinc cobalt green  |
|                      | F42  | – less grommet and backshell   |
|                      | F0   | – less contacts, contacts to be<br>ordered separately<br>see pages 51– 52  |

## With Spring Washer and Friction Ring

These connectors feature a spring washer and a friction ring under the coupling nut.

|                  |   |
|------------------|---|
| Advantage        | Vibrations are being compensated                                  |
| Ordering example | according performance class insert<br>„W“ after Class E, F or R   |
| CA06EW           | – connector with spring washer, endbell<br>with cable and bushing |
| CA06FW           | – connector with spring washer, endbell<br>for flex tube          |
| CA06RW           | – connector with spring washer and short<br>endbell               |
| CA08EW/FW        | – connector with spring washer and<br>90° endbell                 |

The connectors acc. to **VG95234** are generally delivered **with spring washer**.

## Other Shell Styles

|                    |   |
|--------------------|---|
| CA3100E-B-02/03/06 | – adapter for heat shrink boot                      |
| CA3100F-B-08/09    | – 90° endbell for flex tube                         |
| CA3100E-B-08/09    | – 90° endbell, cable clamp and bushing              |
| CA06PG-B           | – PG adapter  |
| CA3101F-B-08/09    | – 90° endbell flex tube                             |
| CA02L-B            | – receptacle with pcb solder contacts               |
| CA20L-B            | – rear mount receptacle with pcb solder<br>contacts |
| CA07A-B            | – jam nut receptacle                                |
| CA00EP-B-TL        | – TINEL-LOCK adapter                                |
| CA06EW-B-TLXX      | – TINEL-LOCK adapter                                |















## Important!

When connectors are requested according to VG 95234 modification, e.g. with another finish, with other contact arrangements and solder contacts, they are to be ordered only with the ITT Cannon order reference.

Connectors acc. to VG95234 are generally available with insert positions X and Y only.

VG order reference with modification is not possible.

# Cannon VG/CA-Bayonet

| View on Mating face of Pin Insulator  | No. of Contacts | Contact arrangement |               | Service rating | Insulator position |     |    |     |     |     | Position | Special polarization | Insulator weight (g) including contacts |        |
|---|-----------------|---------------------|---------------|----------------|--------------------|-----|----|-----|-----|-----|----------|----------------------|---|--------|
|   |                 | Contact size VG     | CA            |                | N                  | V   | W  | X   | Y   | Z   |          |                      | pin                                     | socket |
|      | 3               | 10SL-3<br>15S       | 10SL-3<br>16S | -<br>A         | 0                  | -   | -  | -   | -   | -   | -        | -                    | 6                                       | 9      |
|      | 2               | 10SL-4<br>15S       | 10SL-4<br>16S | A              | 0                  | -   | -  | -   | -   | -   | -        | -                    | 4                                       | 6      |
| ▲    | 2               | -                   | 12S-3<br>16S  | A              | 0                  | 100 | 70 | 145 | 215 | 290 | -        | -                    | 4                                       | 6      |
|      | 1               | -                   | 12S-4<br>16S  | D              | 0                  | -   | -  | -   | -   | -   | 3        | 110                  | 3                                       | 4,5    |
|      | 4               | -                   | 12SA10<br>16S | Instr.         | 0                  | -   | -  | -   | -   | -   | 3<br>8   | 110<br>250           | 6                                       | 8      |
|      | 3               | -                   | 14S-1<br>16S  | A              | 0                  | -   | -  | -   | -   | -   | -        | -                    | 6                                       | 9      |
|      | 4               | -                   | 14S-2<br>16S  | Instr.         | 0                  | -   | -  | 120 | 240 | -   | -        | -                    | 7                                       | 11     |
|      | 1               | -                   | 14S-4<br>16S  | D              | 0                  | -   | -  | -   | -   | -   | -        | -                    | 4                                       | 7      |
|     | 5               | -                   | 14S-5<br>16S  | Instr.         | 0                  | -   | -  | 110 | -   | -   | -        | -                    | 9                                       | 13     |
|    | 6               | 14S-6<br>15S        | 14S-6<br>16S  | Instr.         | 0                  | -   | -  | -   | -   | -   | -        | -                    | 11                                      | 15     |
| ▲  | 3               | -                   | 14S-7<br>16S  | A              | 0                  | -   | 90 | 180 | 270 | -   | -        | -                    | 6                                       | 9      |
|    | 2               | -                   | 14S-9<br>16S  | Instr.         | 0                  | -   | 70 | 145 | 215 | 290 | -        | -                    | 5                                       | 18     |
|    | 7               | -                   | 14SA7<br>16S  | Instr.         | 0                  | -   | -  | -   | -   | -   | -        | -                    | 10                                      | 15     |
| ▲  | 7               | 16S-1<br>15S        | 16S-1<br>16S  | A              | 0                  | -   | 80 | -   | -   | 280 | -        | -                    | 14                                      | 19     |
|    | 2               | 16S-4<br>15S        | 16S-4<br>16S  | D              | 0                  | -   | 35 | 110 | 250 | 325 | -        | -                    | 7                                       | 10     |
| ▲  | 3               | -                   | 16S-5<br>16S  | A              | 0                  | -   | 70 | 145 | 215 | 290 | -        | -                    | 8                                       | 12     |
|    | 5               | -                   | 16S-8<br>16S  | A              | 0                  | -   | -  | 170 | 265 | -   | -        | -                    | 10                                      | 15     |

▲ Attention: for all alternate positions of these contact arrangements a tendency to overmate can be stated. It is within the customer's responsibility to use these insert positions.



Dimensions shown in mm  
Specifications and dimensions subject to change

[www.ittcannon.com](http://www.ittcannon.com)

# Cannon VG/CA-Bayonet

| View on Mating face of Pin Insulator | No. of Contacts | Contact arrangement               |                  | Service rating                              | Insulator position |   |    |     |     |     | Position | Special polarization | Insulator weight (g) including contacts |        |
|--------------------------------------|-----------------|-----------------------------------|------------------|---|--------------------|---|----|-----|-----|-----|----------|----------------------|---|--------|
|                                      |                 | VG                                | CA               |   | N                  | V | W  | X   | Y   | Z   |          |                      | pin                                     | socket |
|                                      | 3<br>2<br>1     | 16-7<br>15<br>100                 | 16-7<br>16<br>8  | A   | 0                  | - | 80 | 110 | 250 | 280 | -        | -                    | 16                                      | 25     |
|                                      | 4<br>2<br>2     | -                                 | 16-9<br>12<br>16 | A   | 0                  | - | 35 | 110 | 250 | 325 | -        | -                    | 13                                      | 20     |
| ▲                                    | 3               | 16-10<br>25                       | 16-10<br>12      | A   | 0                  | - | 90 | 180 | 270 | -   | -        | -                    | 17                                      | 24     |
|                                      | 2               | -                                 | 16-11<br>12      | A   | 0                  | - | 35 | 110 | 250 | 325 | -        | -                    | 11                                      | 17     |
|                                      | 1               | 16-12<br>160                      | 16-12<br>4       | A   | 0                  | - | -  | -   | -   | -   | -        | -                    | 24                                      | 28     |
|                                      | 2               | 16A11<br>25 (socket)<br>25A (pin) | 16A11<br>12      | A   | 0                  | - | 35 | 110 | 250 | 325 | -        | -                    | 11                                      | 17     |
| ▲                                    | 10              | 18-1<br>15                        | 18-1<br>16       | A (B, C,<br>F, G)<br>Instr.<br>(all others) | 0                  | - | 70 | 145 | -   | 290 | -        | -                    | 24                                      | 37     |
|                                      | 2               | -                                 | 18-3<br>12       | D   | 0                  | - | 35 | 110 | 250 | 325 | -        | -                    | 13                                      | 22     |
|                                      | 4               | -                                 | 18-4<br>16       | D   | 0                  | - | 35 | 110 | 250 | 325 | -        | -                    | 19                                      | 30     |
|                                      | 3<br>2<br>1     | -                                 | 18-5<br>12<br>16 | D   | 0                  | - | 80 | 110 | 250 | 280 | -        | -                    | 15                                      | 25     |
|                                      | 1               | -                                 | 18-6<br>4        | D   | 0                  | - | -  | -   | -   | -   | -        | -                    | 24                                      | 32     |
|                                      | 1               | -                                 | 18-7<br>8        | D   | 0                  | - | -  | -   | -   | -   | -        | -                    | 16                                      | 25     |
|                                      | 8<br>1<br>7     | -                                 | 18-8<br>12<br>16 | A   | 0                  | - | 70 | -   | -   | 290 | -        | -                    | 18                                      | 30     |
|                                      | 7<br>2<br>5     | -                                 | 18-9<br>12<br>16 | Instr.                                      | 0                  | - | 80 | 110 | 250 | 280 | -        | -                    | 18                                      | 30     |
|                                      | 4               | -                                 | 18-10<br>12      | A   | 0                  | - | -  | 120 | 240 | -   | -        | -                    | 13                                      | 22     |
|                                      | 5               | 18-11<br>25                       | 18-11<br>12      | A   | 0                  | - | -  | 170 | 265 | -   | -        | -                    | 31                                      | 40     |

▲ Attention: for all alternate positions of these contact arrangements a tendency to overmate can be stated. It is within the customer's responsibility to use these insert positions.

# Cannon VG/CA-Bayonet

| View on Mating face of Pin Insulator | No. of Contacts | Contact arrangement |                   | Service rating                         | Insulator position |   |    |     |     |     | Position | Special polarization | Insulator weight (g) including contacts |        |
|--------------------------------------|-----------------|---------------------|-------------------|--|--------------------|---|----|-----|-----|-----|----------|----------------------|---|--------|
|                                      |                 | Contact size VG     | CA                |  | N                  | V | W  | X   | Y   | Z   |          |                      | pin                                     | socket |
|                                      | 6               | -                   | 18-12<br>16       | A                                      | 0                  | - | 80 | -   | -   | 280 | -        | -                    | 15                                      | 25     |
| ▲                                    | 4               | 18-13               | 18-13             | A                                      | 0                  | - | 80 | 110 | 250 | 280 | -        | -                    | 15                                      | 24     |
|                                      | 7               | -                   | 18-17<br>12<br>16 | Instr.                                 | 0                  | - | -  | -   | -   | -   | 12       | 100                  | 15                                      | 23     |
|                                      | 10              | -                   | 18-19<br>16       | A                                      | 0                  | - | -  | 120 | 240 | -   | -        | -                    | 19                                      | 31     |
|                                      | 5               | -                   | 18-20<br>16       | A                                      | 0                  | - | 90 | 180 | 270 | -   | -        | -                    | 15                                      | 25     |
|                                      | 3               | -                   | 18-21<br>12       | A                                      | 0                  | - | -  | -   | -   | -   | -        | -                    | 17                                      | 28     |
|                                      | 3               | -                   | 18-22<br>16       | D                                      | 0                  | - | 70 | 145 | 215 | 290 | -        | -                    | 10                                      | 20     |
|                                      | 1               | 20-2<br>500         | 20-2<br>0         | D                                      | 0                  | - | -  | -   | -   | -   | -        | -                    | 46                                      | 55     |
|                                      | 3               | -                   | 20-3<br>12        | D                                      | 0                  | - | 70 | 145 | 215 | 290 | -        | -                    | 28                                      | 42     |
|                                      | 4               | -                   | 20-4<br>12        | D                                      | 0                  | - | 45 | 110 | 250 | -   | -        | -                    | 24                                      | 40     |
|                                      | 3               | -                   | 20-6<br>16        | D                                      | 0                  | - | -  | -   | -   | -   | -        | -                    | 22                                      | 36     |
|                                      | 8               | -                   | 20-7<br>16        | A (C, D,<br>E, F)<br>D (A, B,<br>H, G) | 0                  | - | 80 | 110 | 250 | 280 | -        | -                    | 28                                      | 42     |
|                                      | 6               | 20-8<br>100<br>15   | 20-8<br>8<br>16   | Instr.                                 | 0                  | - | 80 | 110 | 250 | 280 | -        | -                    | 37                                      | 49     |
|                                      | 13              | -                   | 20-11<br>16       | Instr.                                 | 0                  | - | -  | -   | -   | -   | -        | -                    | 25                                      | 41     |

▲ Attention: for all alternate positions of these contact arrangements a tendency to overmate can be stated. It is within the customer's responsibility to use these insert positions.



Dimensions shown in mm  
Specifications and dimensions subject to change

[www.ittcannon.com](http://www.ittcannon.com)

# Cannon VG/CA-Bayonet

| View on Mating face of Pin Insulator  | No. of Contacts | Contact arrangement |                   | Service rating | Insulator position |   |    |     |     |     | Position | Special polarization | Insulator weight (g) including contacts |        |
|---|-----------------|---------------------|-------------------|----------------|--------------------|---|----|-----|-----|-----|----------|----------------------|---|--------|
|   |                 | Contact size VG     | CA                |                | N                  | V | W  | X   | Y   | Z   |          |                      | pin                                     | socket |
|    | 5<br>3<br>2     | -                   | 20-14<br>12<br>8  | A              | 0                  | - | 80 | 110 | 250 | 280 | -        | -                    | 22                                      | 39     |
|    | 7               | -                   | 20-15<br>12       | A              | 0                  | - | 80 | -   | -   | 280 | -        | -                    | 27                                      | 46     |
|    | 9<br>2<br>7     | -                   | 20-16<br>12<br>16 | A              | 0                  | - | 80 | 110 | 250 | 280 | -        | -                    | 19                                      | 32     |
|    | 6<br>5<br>1     | -                   | 20-17<br>12<br>16 | A              | 0                  | - | 90 | 180 | 270 | -   | -        | -                    | 20                                      | 33     |
|    | 9<br>3<br>6     | -                   | 20-18<br>12<br>16 | A              | -                  | - | 35 | 110 | 250 | 325 | -        | -                    | 19                                      | 32     |
|    | 3               | -                   | 20-19<br>8        | A              | 0                  | - | 90 | 180 | 270 | -   | -        | -                    | 33                                      | 46     |
|   | 6<br>3<br>3     | -                   | 20-22<br>8<br>16  | A              | -                  | - | 80 | 110 | 250 | 280 | -        | -                    | 37                                      | 49     |
|  | 2               | -                   | 20-23<br>8        | A              | -                  | - | 35 | 110 | 250 | 325 | -        | -                    | 25                                      | 35     |
|  | 4<br>2<br>2     | -                   | 20-24<br>8<br>16  | A              | 0                  | - | 35 | 110 | 250 | 325 | -        | -                    | 40                                      | 53     |
|  | 14              | -                   | 20-27<br>16       | A              | 0                  | - | 35 | 110 | 250 | 325 | -        | -                    | 26                                      | 42     |
|  | 17              | -                   | 20-29<br>16       | A              | 0                  | - | 80 | -   | -   | 280 | -        | -                    | 29                                      | 47     |

▲ Attention: for all alternate positions of these contact arrangements a tendency to overmate can be stated. It is within the customer's responsibility to use these insert positions.



# Cannon VG/CA-Bayonet

| View on Mating<br>face of Pin Insulator | No.<br>of<br>Contacts | Contact arrangement |                  | Service<br>rating               | Insulator position |   |    |     |     |              | Position          | Special<br>polarization | Insulator weight<br>(g)<br>including contacts |        |
|---|-----------------------|---------------------|------------------|---------------------------------|--------------------|---|----|-----|-----|--------------|-------------------|-------------------------|---|--------|
|   |                       | Contact size<br>VG  | CA               |                                 | N                  | V | W  | X   | Y   | Z            |                   |                         | pin   | socket |
|   | 11                    | -                   | 20-33<br>16      | A                               | 0                  | - | -  | -   | -   | 2<br>3<br>17 | 260<br>110<br>130 | -                       | 23  | 38     |
|   | 9                     | 20A9<br>25          | 20A9<br>12       | D (J)<br>Instr.<br>(all others) | 0                  | - | -  | 110 | 250 | -            | -                 | -                       | 21  | 35     |
|   | 19                    | 20A48<br>15         | 20A48<br>16      | Instr.                          | 0                  | - | -  | 80  | 280 | -            | -                 | -                       | 30  | 50     |
|   | 2                     | -                   | 22-1<br>8        | D                               | 0                  | - | 35 | 110 | 250 | 325          | -                 | -                       | 28  | 42     |
|   | 3                     | 22-2<br>8           | 22-2<br>8        | D                               | 0                  | - | 70 | 145 | 215 | 290          | -                 | -                       | 35  | 50     |
|   | 4<br>2<br>2           | -                   | 22-4<br>8<br>12  | A                               | -                  | - | 35 | 110 | 250 | 325          | -                 | -                       | 34  | 48     |
|   | 6<br>2<br>4           | -                   | 22-5<br>12<br>16 | D                               | -                  | - | 35 | 110 | 250 | 325          | -                 | -                       | 23  | 38     |
|   | 1                     | -                   | 22-7<br>0        | E                               | 0                  | - | -  | -   | -   | -            | -                 | -                       | 45  | 57     |
|   | 2                     | -                   | 22-8<br>12       | E                               | -                  | - | 35 | 110 | 250 | 325          | -                 | -                       | 18  | 28     |
|   | 3                     | -                   | 22-9<br>12       | E                               | 0                  | - | 70 | 145 | 215 | 290          | -                 | -                       | 21  | 32     |

▲ Attention: for all alternate positions of these contact arrangements a tendency to overmate can be stated. It is within the customer's responsibility to use these insert positions.

# Cannon VG/CA-Bayonet

| View on Mating face of Pin Insulator  | No. of Contacts | Contact arrangement |                   | Service rating             | Insulator position |   |    |     |     |     | Position | Special polarization | Insulator weight (g) including contacts pin socket |    |
|---|-----------------|---------------------|-------------------|----------------------------|--------------------|---|----|-----|-----|-----|----------|----------------------|--|----|
|   |                 | Contact size VG     | CA                |                            | N                  | V | W  | X   | Y   | Z   |          |                      |  |    |
|    | 4               | -                   | 22-10<br>16       | E                          | -                  | - | 35 | 110 | 250 | 325 | -        | -                    | 17   | 31 |
|    | 5<br>2<br>3     | 22-12<br>100<br>15  | 22-12<br>8<br>16  | D                          | 0                  | - | 80 | 110 | 250 | 280 | -        | -                    | 28   | 42 |
| ▲  | 19              | 22-14<br>15         | 22-14<br>16       | A                          | 0                  | - | 80 | -   | -   | 280 | -        | -                    | 30   | 50 |
|    | 6<br>5<br>1     | -                   | 22-15<br>12<br>16 | A (A, B, C, E, F)<br>E (D) | 0                  | - | 80 | 110 | 250 | 280 | -        | -                    | 30   | 50 |
|    | 9<br>3<br>6     | -                   | 22-16<br>12<br>16 | A                          | 0                  | - | 80 | 110 | 250 | 280 | -        | -                    | 28   | 45 |
|   | 14              | -                   | 22-19<br>16       | A                          | 0                  | - | 80 | 110 | 250 | 280 | -        | -                    | 28   | 47 |
|  | 9               | -                   | 22-20<br>16       | A                          | 0                  | - | 35 | 110 | 250 | 325 | -        | -                    | 22   | 39 |
|  | 3<br>2<br>1     | -                   | 22-21<br>16<br>0  | A                          | 0                  | - | 80 | 110 | 250 | 280 | -        | -                    | 49   | 58 |
|  | 4               | 22-22<br>100        | 22-22<br>8        | A                          | 0                  | - | -  | 110 | 250 | -   | -        | -                    | 42   | 58 |
|  | 8               | -                   | 22-23<br>12       | D (H)<br>A (all others)    | 0                  | - | 35 | -   | 250 | -   | -        | -                    | 34   | 54 |
|  | 9<br>1<br>8     | 22-27<br>60<br>15   | 22-27<br>8<br>16  | A (A to H)<br>D (J)        | 0                  | - | 80 | -   | 250 | 280 | -        | -                    | 21   | 34 |

▲ Attention: for all alternate positions of these contact arrangements a tendency to overmate can be stated. It is within the customer's responsibility to use these insert positions.

# Cannon VG/CA-Bayonet

| View on Mating<br>face of Pin Insulator | No.<br>of<br>Contacts | Contact arrangement     |                  | Service<br>rating | Insulator position |   |    |     |     |     | Position | Special<br>polarization | Insulator weight<br>(g)<br>including contacts<br>pin socket |        |
|---|-----------------------|-------------------------|------------------|-------------------|--------------------|---|----|-----|-----|-----|----------|-------------------------|---|--------|
|   |                       | Contact size<br>VG      | CA               |                   | N                  | V | W  | X   | Y   | Z   |          |                         | pin   | socket |
|   | 7                     | -                       | 22-28<br>12      | A                 | -                  | - | 80 | -   | -   | 280 | -        | -                       | 33  | 50     |
|   | 4                     | 22B22<br>60             | -                | A                 | 0                  | - | -  | 110 | 250 | -   | -        | -                       | 42  | 58     |
|   | 7                     | -                       | 24-2<br>12       | D                 | 0                  | - | 80 | -   | -   | 280 | -        | -                       | 33  | 53     |
|   | 4<br>1<br>3           | -                       | 24-4<br>0<br>16  | D                 | -                  | - | 80 | 110 | 250 | 280 | -        | -                       | 51  | 63     |
|   | 16                    | -                       | 24-5<br>16       | A                 | -                  | - | 80 | 110 | 250 | 280 | -        | -                       | 30  | 54     |
|   | 8<br>8                | -                       | 24-6<br>12       | A<br>(B,C,D,E,F)  | 0                  | - | 80 | 110 | 250 | 280 | -        | -                       | 32  | 41     |
|   | 16<br>2<br>14         | -                       | 24-7<br>12<br>16 | A                 | 0                  | - | 80 | 110 | 250 | 280 | -        | -                       | 45  | 65     |
|   | 2                     | -                       | 24-9<br>4        | A                 | 0                  | - | 35 | 110 | 250 | 325 | -        | -                       | 45  | 60     |
|   | 7                     | 24-10<br>100            | 24-10<br>8       | A                 | 0                  | - | 80 | -   | -   | 280 | -        | -                       | 65  | 85     |
|   | 9<br>3<br>6           | 24-11<br>100/8<br>25/12 | 24-11<br>8<br>12 | A                 | 0                  | - | 35 | 110 | 250 | 325 | -        | -                       | 55  | 75     |

▲ Attention: for all alternate positions of these contact arrangements a tendency to overmate can be stated. It is within the customer's responsibility to use these insert positions.



# Cannon VG/CA-Bayonet

| View on Mating face of Pin Insulator  | No. of Contacts  | Contact arrangement |                       | Service rating | Insulator position |   |    |     |     |     | Position          | Special polarization    | Insulator weight (g) including contacts pin socket |    |
|---|------------------|---------------------|-----------------------|----------------|--------------------|---|----|-----|-----|-----|-------------------|-------------------------|--|----|
|   |                  | Contact size VG     | CA                    |                | N                  | V | W  | X   | Y   | Z   |                   |                         |  |    |
|    | 5<br>2<br>3      | 24-12<br>4<br>12    | 24-12<br>4<br>12      | A              | 0                  | - | 80 | 110 | 250 | 280 | -                 | -                       | 60   | 80 |
|    | 12               | -                   | 24-19<br>16           | A              | 0                  | - | -  | -   | -   | -   | -                 | -                       | 28   | 47 |
|    | 11<br>2<br>9     | -                   | 24-20<br>12<br>16     | D              | 0                  | - | 80 | 110 | 250 | 280 | -                 | -                       | 40   | 60 |
|    | 4                | -                   | 24-22<br>8            | D              | 0                  | - | 45 | 110 | 250 | -   | -                 | -                       | 44   | 61 |
|    | 7                | -                   | 24-27<br>16           | E              | -                  | - | 80 | -   | -   | 280 | -                 | -                       | 21   | 37 |
|   | 24               | 24-28<br>15         | 24-28<br>16           | Instr.         | 0                  | - | 80 | 110 | 250 | 280 | -                 | -                       | 40   | 65 |
|  | 12               | -                   | 24A24<br>12           | A              | -                  | - | -  | -   | -   | -   | 2<br>4<br>9<br>12 | 260<br>80<br>280<br>100 | 46   | 71 |
|  | 28               | -                   | 24A28<br>16           | Instr.         | -                  | - | 65 | 146 | 235 | -   | -                 | -                       | 42   | 75 |
|  | 14<br>12<br>2    | -                   | 28-2<br>16<br>12      | D              | -                  | - | 35 | 110 | 250 | 325 | -                 | -                       | 43   | 61 |
|  | 5<br>2<br>2<br>1 | -                   | 28-5<br>4<br>16<br>12 | D              | -                  | - | 35 | 110 | 250 | 325 | -                 | -                       | 60   | 70 |

▲ Attention: for all alternate positions of these contact arrangements a tendency to overmate can be stated. It is within the customer's responsibility to use these insert positions.



# Cannon VG/CA-Bayonet

| View on Mating<br>face of Pin Insulator  | No.<br>of<br>Contacts | Contact arrangement |                       | Service<br>rating                              | Insulator position |   |    |     |     |     | Position | Special<br>polarization | Insulator weight<br>(g)<br>including contacts<br>pin<br>socket |     |
|--|-----------------------|---------------------|-----------------------|--|--------------------|---|----|-----|-----|-----|----------|-------------------------|--|-----|
|  |                       | Contact size<br>VG  | CA                    |  | N                  | V | W  | X   | Y   | Z   |          |                         |  |     |
|    | 12<br>6<br>6          | -                   | 28-9<br>16<br>12      | D  | -                  | - | 80 | 110 | 250 | 280 | -        | -                       | 46   | 65  |
|    | 7<br>2<br>2<br>3      | -                   | 28-10<br>4<br>8<br>12 | A (= A, B, C,<br>D, E, F)<br>D (= G)           | -                  | - | 80 | 110 | 250 | 280 | -        | -                       | 80   | 91  |
|    | 22<br>4<br>18         | 28-11<br>25<br>15   | 28-11<br>12<br>16     | A  | 0                  | - | 80 | 110 | 250 | 280 | -        | -                       | 65   | 110 |
|    | 26                    | -                   | 28-12<br>16           | A  | 0                  | - | 90 | 180 | 270 | -   | -        | -                       | 47   | 77  |
|    | 35                    | -                   | 28-15<br>16           | A  | 0                  | - | 80 | 110 | 250 | 280 | -        | -                       | 54   | 90  |
|  | 20                    | -                   | 28-16<br>16           | A (A-L)<br>D (M, N, P)<br>B (R)                | 0                  | - | 80 | 110 | 250 | 280 | -        | -                       | 41   | 68  |
|  | 10<br>6<br>4          | -                   | 28-19<br>16<br>12     | A (= C, E, G, J, K, L)<br>D = A, B<br>B = H, M | -                  | - | 80 | 110 | 250 | 280 | -        | -                       | 40   | 58  |
|  | 14<br>10<br>4         | 28-20<br>25<br>15   | 28-20<br>12<br>16     | A  | 0                  | - | 80 | 110 | 250 | 280 | -        | -                       | 65   | 110 |







▲ Attention: for all alternate positions of these contact arrangements a tendency to overmate can be stated. It is within the customer's responsibility to use these insert positions.

# Cannon VG/CA-Bayonet

| View on Mating face of Pin Insulator                                      | No. of Contacts | Contact arrangement     |                   | Service rating                  | Insulator position |   |    |     |     |     | Position | Special polarization | Insulator weight (g) including contacts |        |
|---|-----------------|-------------------------|-------------------|---------------------------------|--------------------|---|----|-----|-----|-----|----------|----------------------|---|--------|
|   |                 | Contact size VG         | CA                |                                 | N                  | V | W  | X   | Y   | Z   |          |                      | pin                                     | socket |
|   | 37              | 28-21<br>15             | 28-21<br>16       | A                               | 0                  | - | 80 | 110 | 250 | 280 | -        | -                    | 58                                      | 93     |
|   | 6               | 28-22<br>160/4<br>15/16 | 28-22<br>4<br>16  | D                               | 0                  | - | 70 | 145 | 215 | 290 | -        | -                    | 80                                      | 120    |
| All alternating insert position as above are permitted for VG95234 types. |                 |                         |                   |                                 |                    |   |    |     |     |     |          |                      |   |        |
|   | 12              | -                       | 28-51<br>12       | D                               | -                  | - | 80 | 135 | 195 | -   | -        | -                    | 57                                      | 77     |
|   | 9               | -                       | 28A16<br>4<br>16  | A (e)<br>Instr.<br>(all others) | 0                  | - | -  | -   | -   | -   | 2        | 260                  | 100                                     | 135    |
|   | 4               |                         |                   |                                 | -                  | - | -  | -   | -   | -   | 3        | 110                  |   |        |
|   | 5               |                         |                   |                                 | -                  | - | -  | -   | -   | -   | 8        | 250                  |   |        |
|   |                 |                         |                   |                                 | -                  | - | -  | -   | -   | -   | 9        | 280                  |   |        |
|   | 43              | -                       | 28A51<br>16       | A                               | 0                  | - | -  | -   | -   | -   | 3        | 110                  | 64                                      | 107    |
|   |                 |                         |                   |                                 | -                  | - | -  | -   | -   | -   | 4        | 80                   |   |        |
|   |                 |                         |                   |                                 | -                  | - | -  | -   | -   | -   | 8        | 250                  |   |        |
|   |                 |                         |                   |                                 | -                  | - | -  | -   | -   | -   | 9        | 280                  |   |        |
|   |                 |                         |                   |                                 | -                  | - | -  | -   | -   | -   | 12       | 100                  |   |        |
|   | 28              | 28A63<br>25<br>15       | 28A63<br>12<br>16 | A                               | 0                  | - | -  | 100 | 260 | -   | -        | -                    | 85                                      | 135    |
|   | 5               | 32-1<br>500/0<br>25/12  | 32-1<br>0<br>12   | E (A)<br>D (all others)         | 0                  | - | 80 | 110 | 250 | 280 | -        | -                    | 130                                     | 155    |
|   | 2               | 32-5<br>0               | 32-5<br>0         | D                               | 0                  | - | 35 | 110 | 250 | 325 | -        | -                    | 86                                      | 114    |

▲ Attention: for all alternate positions of these contact arrangements a tendency to overmate can be stated. It is within the customer's responsibility to use these insert positions.

# Cannon VG/CA-Bayonet

| View on Mating face of Pin Insulator   | No. of Contacts         | Contact arrangement                     |                            | Service rating                            | Insulator position |   |    |     |     |     | Position | Special polarization | Insulator weight (g) including contacts |        |
|--|-------------------------|---|----------------------------|---|--------------------|---|----|-----|-----|-----|----------|----------------------|---|--------|
|  |                         | VG                                      | CA                         |   | N                  | V | W  | X   | Y   | Z   |          |                      | pin                                     | socket |
|    | 23<br>2<br>3<br>2<br>16 | 32-6<br>160/4<br>60/8<br>25/12<br>15/16 | 32-6<br>4<br>8<br>12<br>16 | A   | 0                  | - | 80 | 110 | 250 | 280 | -        | -                    | 130                                     | 170    |
|    | 35<br>7<br>28           | 32-7<br>25<br>15                        | 32-7<br>12<br>16           | Instr.<br>(A, B, U, I.)<br>A (all others) | 0                  | - | 80 | 125 | 235 | 280 | -        | -                    | 110                                     | 160    |
|    | 30<br>6<br>24           | -                                       | 32-8<br>12<br>16           | A   | 0                  | - | 80 | 125 | 235 | 280 | -        | -                    | 105                                     | 155    |
|    | 14<br>12<br>2           | -                                       | 32-9<br>16<br>4            | D   | 0                  | - | 80 | 110 | 250 | 280 | -        | -                    | 79                                      | 130    |
|   | 23<br>5<br>18           | -                                       | 32-13<br>12<br>16          | D   | 0                  | - | 80 | 110 | 250 | 280 | -        | -                    | 95                                      | 145    |
|  | 8<br>2<br>6             | -                                       | 32-15<br>0<br>12           | D   | 0                  | - | 35 | 110 | 250 | 325 | -        | -                    | 140                                     | 165    |
|  | 4                       | -                                       | 32-17<br>4                 | D   | 0                  | - | 45 | 110 | 250 | -   | -        | -                    | 80                                      | 116    |

▲ Attention: for all alternate positions of these contact arrangements a tendency to overmate can be stated. It is within the customer's responsibility to use these insert positions.



Dimensions shown in mm  
Specifications and dimensions subject to change

[www.ittcannon.com](http://www.ittcannon.com)







# Cannon VG/CA-Bayonet

| View on Mating face of Pin Insulator                                     | No. of Contacts | Contact arrangement    |                   | Service rating | Insulator position |   |    |     |     |     | Position                    | Special polarization                  | Insulator weight (g) including contacts |        |
|--|-----------------|------------------------|-------------------|----------------|--------------------|---|----|-----|-----|-----|-----------------------------|---------------------------------------|---|--------|
|  |                 | Contact size VG        | CA                |                | N                  | V | W  | X   | Y   | Z   |                             |                                       | pin                                     | socket |
|  | 54              | -                      | 32A10<br>16       | A              | -                  | - | -  | -   | -   | -   | 2<br>3<br>4<br>8<br>9<br>12 | 260<br>110<br>80<br>250<br>280<br>100 | 89                                      | 132    |
|  | 47              | -                      | 32A47<br>16       | A              | -                  | - | -  | -   | -   | -   | 2<br>3<br>4<br>8<br>9<br>12 | 260<br>110<br>80<br>250<br>280<br>100 | 73                                      | 120    |
|  | 55              |                        | 32A55<br>16       | A              | -                  | - | 80 | 110 | 250 | 280 | -                           | -                                     | 90                                      | 134    |
|  | 61<br>20<br>41  | 32A69<br>15<br>10      | 32A69<br>16<br>20 | Instr.         | 0                  | - | -  | 110 | 250 | -   | -                           | -                                     | 49                                      | 84     |
| Not for through-bulkhead receptacle C1 / C2.                             |                 |                        |                   |                |                    |   |    |     |     |     |                             |                                       |   |        |
|  | 6<br>3<br>3     | 36-3<br>500/0<br>25/12 | 36-3<br>0<br>12   | D              | 0                  | - | 70 | 145 | 215 | 290 | -                           | -                                     | 165                                     | 200    |
| All alternating insert position as above are permitted for VG95234 type. |                 |                        |                   |                |                    |   |    |     |     |     |                             |                                       |   |        |
|  | 4               | 36-5<br>500/0          | 36-5<br>0         | A              | 0                  | - | -  | 120 | 240 | -   | -                           | -                                     | 152                                     | 181    |
|  | 6<br>4<br>2     | 36-6<br>4<br>0         | 36-6<br>4<br>0    | A              | 0                  | - | 35 | 110 | 250 | 325 | -                           | -                                     | 155                                     | 173    |

▲ Attention: for all alternate positions of these contact arrangements a tendency to overmate can be stated. It is within the customer's responsibility to use these insert positions.



# Cannon VG/CA-Bayonet

| View on Mating face of Pin Insulator   | No. of Contacts          | Contact arrangement |                            | Service rating          | Insulator position |   |    |     |     |     | Position | Special polarization | Insulator weight (g) including contacts pin socket |     |
|--|--------------------------|---------------------|----------------------------|-------------------------|--------------------|---|----|-----|-----|-----|----------|----------------------|--|-----|
|  |                          | Contact size VG     | CA                         |                         | N                  | V | W  | X   | Y   | Z   |          |                      |  |     |
|    | 47<br>7<br>40            | -                   | 36-7<br>12<br>16           | A                       | -                  | - | 80 | 110 | 250 | 280 | -        | -                    | 92   | 144 |
|    | 47<br>1<br>46            | -                   | 36-8<br>12<br>16           | A                       | -                  | - | 80 | 110 | 250 | 280 | -        | -                    | 80   | 132 |
|    | 31<br>14<br>14<br>2<br>1 | -                   | 36-9<br>16<br>12<br>8<br>4 | A                       | 0                  | - | 80 | 125 | 235 | 280 | -        | -                    | 116  | 159 |
|   | 48                       | 36-10<br>15         | 36-10<br>16                | A                       | 0                  | - | 80 | 125 | 235 | 280 | -        | -                    | 79   | 133 |
|  | 16<br>5<br>5<br>6        | -                   | 36-14<br>8<br>12<br>16     | D                       | 0                  | - | -  | -   | -   | -   | -        | -                    | 150  | 230 |
|  | 35                       | -                   | 36-15<br>16                | D (m)<br>A (all others) | 0                  | - | 60 | 125 | 245 | 305 | -        | -                    | 70   | 111 |

▲ Attention: for all alternate positions of these contact arrangements a tendency to overmate can be stated. It is within the customer's responsibility to use these insert positions.



Dimensions shown in mm  
Specifications and dimensions subject to change

[www.ittcannon.com](http://www.ittcannon.com)

# Cannon VG/CA-Bayonet

| View on Mating face of Pin Insulator  | No. of Contacts | Contact arrangement |                    | Service rating | Insulator position |   |    |     |   |   | Position                          | Special polarization                         | Insulator weight (g) including contacts |        |
|---|-----------------|---------------------|--------------------|----------------|--------------------|---|----|-----|---|---|-----------------------------------|--|---|--------|
|   |                 | Contact size VG     | CA                 |                | N                  | V | W  | X   | Y | Z |                                   |  | pin                                     | socket |
|    | 52              | -                   | 36A34<br>16        | A              | -                  | - | -  | -   | - | - | 2<br>3<br>4<br>8<br>9<br>12<br>20 | 260<br>110<br>80<br>250<br>280<br>100<br>220 | 83                                      | 139    |
|    | 8<br>4<br>4     | -                   | 36A35<br>16<br>0   | A              | -                  | - | -  | -   | - | - | 2<br>3<br>8<br>9                  | 260<br>110<br>250<br>280                     | 172                                     | 183    |
|    | 27              | -                   | 36A46<br>12        | A              | -                  | - | -  | -   | - | - | 2<br>3<br>4<br>8<br>9<br>12       | 260<br>110<br>80<br>250<br>280<br>100        | 112                                     | 154    |
|   | 39<br>8<br>31   | -                   | 36A98<br>8<br>16   | Instr.         | 0                  | - | -  | -   | - | - | -                                 | -  | 160                                     | 140    |
|  | 65<br>15<br>50  | -                   | 36A99<br>16<br>20* | Instr.         | -                  | - | 30 | 135 | - | - | -                                 | -  | 80                                      | 121    |

\* reduced contact termination 0,3 mm<sup>2</sup>

▲ Attention: for all alternate positions of these contact arrangements a tendency to overmate can be stated. It is within the customer's responsibility to use these insert positions.

## Alternate Insert Positions

Indicates location of centerline of key or keyway of shells in fixed normal position. Insert is rotated as shown by arrow and letters.

Connectors according to VG95234 are generally available with insert positions X and Y only.

- Tolerances:
- # 10SL-20:  $\pm 2^\circ$
  - # 22-36:  $\pm 1,5^\circ$
  - # 32A69:  $\pm 1^\circ$





**Special Insert Alternations**

Special insert alternations are marked by positions. The position number indicates the turning of the contact insert in the direction of the polarizing key in view of the mating or termination side of the socket insulator.

| Contact arrangement | Position of | Contact arrangement | Polarization |
|---------------------|-------------|---------------------|--------------|
| 12SA10              | 3           | 12SA10              | 110°         |
|                     | 8           | 12SA10              | 250°         |
| 18-17               | 12          | 18-9                | 100°         |
| 24A24               | 2           | 24A24               | 260°         |
|                     | 4           | 24A24               | 80°          |
|                     | 9           | 24A24               | 280°         |
|                     | 12          | 24A24               | 100°         |
| 32-16               | 12          | 32-6                | 100°         |

| Position | Polarization |
|----------|--------------|
| 2        | 260°         |
| 3        | 110°         |
| 4        | 80°          |
| 5        | use pos. 3   |
| 6        | 85°          |
| 8        | 250°         |
| 9        | 280°         |
| 11       | 105°         |
| 12       | 100°         |
| 13       | use pos. 8   |
| 14       | 30°          |
| 15       | 45°          |
| 16       | 120°         |
| 17       | 130°         |
| 18       | 150°         |
| 19       | 195°         |
| 20       | 220°         |
| 21       | 255°         |
| 22       | 290°         |
| 23       | 165°         |
| 24       | 330°         |
| 25       | 235°         |
| 26       | 125°         |

**Positions**

View shows mating side of pin or termination side of socket.



Insert positions are added without hyphen directly behind the contact type.

Example:  
CA3106F32A10P[2]-B-01



# Cannon VG/CA-Bayonet

## Contact Arrangements

| Contact arrangement | No. of contacts | Contact size |          |                |          |          |          |
|---------------------|-----------------|--------------|----------|----------------|----------|----------|----------|
|                     |                 | 0<br>500     | 4<br>160 | 8<br>100<br>60 | 12<br>25 | 16<br>15 | 20<br>10 |
| 12S4                | 1               |              |          |                |          | 1        |          |
| 14S4                | 1               |              |          |                |          | 1        |          |
| 16-12               | 1               |              | 1        |                |          |          |          |
| 18-6                | 1               |              | 1        |                |          |          |          |
| 18-7                | 1               |              |          | 1              |          |          |          |
| 20-2                | 1               | 1            |          |                |          |          |          |
| 22-7                | 1               | 1            |          |                |          |          |          |
| 10SL4               | 2               |              |          |                |          | 2        |          |
| 14S9                | 2               |              |          |                |          | 2        |          |
| 16S4                | 2               |              |          |                |          | 2        |          |
| 16-11               | 2               |              |          |                | 2        |          |          |
| 16A11               | 2               |              |          |                | 2        |          |          |
| 18-3                | 2               |              |          |                | 2        |          |          |
| 20-23               | 2               |              |          | 2              |          |          |          |
| 22-1                | 2               |              |          | 2              |          |          |          |
| 22-8                | 2               |              |          |                | 2        |          |          |
| 24-9                | 2               |              | 2        |                |          |          |          |
| 32-5                | 2               | 2            |          |                |          |          |          |
| 10SL3               | 3               |              |          |                |          | 3        |          |
| 14S1                | 3               |              |          |                |          | 3        |          |
| 14S7                | 3               |              |          |                |          | 3        |          |
| 16S5                | 3               |              |          |                |          | 3        |          |
| 16-7                | 3               |              |          | 1              |          | 2        |          |
| 16-10               | 3               |              |          |                | 3        |          |          |
| 18-5                | 3               |              |          |                | 2        | 1        |          |
| 18-21               | 3               |              |          |                | 3        |          |          |
| 18-22               | 3               |              |          |                |          | 3        |          |
| 20-6                | 3               |              |          |                |          | 3        |          |
| 20-19               | 3               |              |          | 3              |          |          |          |
| 22-2                | 3               |              |          | 3              |          |          |          |
| 22-9                | 3               |              |          | 3              |          |          |          |
| 22-21               | 3               | 1            |          |                |          | 2        |          |
| 12SA10              | 4               |              |          |                |          | 4        |          |
| 14S2                | 4               |              |          |                |          | 4        |          |
| 16-9                | 4               |              |          |                | 2        | 2        |          |
| 18-4                | 4               |              |          |                |          | 4        |          |
| 18-10               | 4               |              |          |                | 4        |          |          |
| 18-13               | 4               |              |          | 1              | 3        |          |          |
| 20-4                | 4               |              |          |                | 4        |          |          |
| 20-24               | 4               |              |          | 2              |          | 2        |          |
| 22-4                | 4               |              |          | 2              | 2        |          |          |
| 22-10               | 4               |              |          |                |          | 4        |          |
| 22-22               | 4               |              |          | 4              |          |          |          |
| 22B22               | 4               |              |          | 4              |          |          |          |
| 24-4                | 4               | 1            |          |                |          | 3        |          |
| 24-22               | 4               |              |          | 4              |          |          |          |
| 32-17               | 4               |              | 4        |                |          |          |          |
| 36-5                | 4               | 4            |          |                |          |          |          |

| Contact arrangement | No. of contacts | Contact size |          |                |          |          |          |
|---------------------|-----------------|--------------|----------|----------------|----------|----------|----------|
|                     |                 | 0<br>500     | 4<br>160 | 8<br>100<br>60 | 12<br>25 | 16<br>15 | 20<br>10 |
| 14S5                | 5               |              |          |                |          | 5        |          |
| 16S8                | 5               |              |          |                |          | 5        |          |
| 18-11               | 5               |              |          |                | 5        |          |          |
| 18-20               | 5               |              |          |                |          | 5        |          |
| 22-12               | 5               |              |          | 2              |          | 3        |          |
| 24-12               | 5               |              | 2        |                |          | 3        |          |
| 28-5                | 5               |              | 2        |                |          | 1        | 2        |
| 32-1                | 5               | 2            |          |                |          | 3        |          |
| 14S6                | 6               |              |          |                |          | 6        |          |
| 18-12               | 6               |              |          |                |          | 6        |          |
| 20-8                | 6               |              |          | 2              |          | 4        |          |
| 20-22               | 6               |              |          | 3              |          | 3        |          |
| 22-5                | 6               |              |          |                | 2        | 4        |          |
| 22-15               | 6               |              |          |                | 5        | 1        |          |
| 28-22               | 6               |              | 3        |                |          | 3        |          |
| 36-3                | 6               | 3            |          |                | 3        |          |          |
| 36-6                | 6               | 2            | 4        |                |          |          |          |
| 14SA7               | 7               |              |          |                |          | 7        |          |
| 16S1                | 7               |              |          |                |          | 7        |          |
| 18-9                | 7               |              |          |                | 2        | 5        |          |
| 18-17               | 7               |              |          |                | 2        | 5        |          |
| 20-15               | 7               |              |          |                | 7        |          |          |
| 22-28               | 7               |              |          |                | 7        |          |          |
| 24-2                | 7               |              |          |                | 7        |          |          |
| 24-10               | 7               |              |          | 7              |          |          |          |
| 24-27               | 7               |              |          |                |          | 7        |          |
| 28-10               | 7               |              | 2        | 2              | 3        |          |          |
| 18-8                | 8               |              |          |                | 1        | 7        |          |
| 20-7                | 8               |              |          |                |          | 8        |          |
| 22-23               | 8               |              |          |                | 8        |          |          |
| 32-15               | 8               | 2            |          |                | 6        |          |          |
| 36A35               | 8               | 4            |          |                |          | 4        |          |
| 20-16               | 9               |              |          |                | 2        | 7        |          |
| 20-18               | 9               |              |          |                | 3        | 6        |          |
| 20A9                | 9               |              |          |                | 9        |          |          |
| 22-16               | 9               |              |          |                | 3        | 6        |          |
| 22-20               | 9               |              |          |                |          | 9        |          |
| 22-27               | 9               |              |          | 1              |          | 8        |          |
| 24-11               | 9               |              |          | 3              | 6        |          |          |
| 28A16               | 9               |              | 4        |                |          | 5        |          |
| 18-1                | 10              |              |          |                |          | 10       |          |
| 18-19               | 10              |              |          |                |          | 10       |          |
| 28-19               | 10              |              |          |                | 4        | 6        |          |
| 20-33               | 11              |              |          |                |          | 11       |          |
| 24-20               | 11              |              |          |                | 2        | 9        |          |



Dimensions shown in mm  
Specifications and dimensions subject to change

[www.ittcannon.com](http://www.ittcannon.com)

# Cannon VG/CA-Bayonet

## Contact Arrangements

| Contact arrangement | No. of contacts | Contact size |          |                |          |          |          |
|---------------------|-----------------|--------------|----------|----------------|----------|----------|----------|
|                     |                 | 0<br>500     | 4<br>160 | 8<br>100<br>60 | 12<br>25 | 16<br>15 | 20<br>10 |
| 24-19               | 12              |              |          |                |          |          | 12       |
| 24A24               | 12              |              |          |                | 12       |          |          |
| 28-9                | 12              |              |          |                | 6        | 6        |          |
| 28-51               | 12              |              |          |                | 12       |          |          |
| 20-11               | 13              |              |          |                |          |          | 13       |
| 20-27               | 14              |              |          |                |          |          | 14       |
| 22-19               | 14              |              |          |                |          |          | 14       |
| 28-2                | 14              |              |          |                | 2        | 12       |          |
| 28-20               | 14              |              |          |                | 10       | 4        |          |
| 32-9                | 14              | 2            |          |                |          | 12       |          |
| 24-5                | 16              |              |          |                |          |          | 16       |
| 24-7                | 16              |              |          |                | 2        | 14       |          |
| 36-14               | 16              |              |          | 5              | 5        | 6        |          |
| 20-29               | 17              |              |          |                |          |          | 17       |
| 20A48               | 19              |              |          |                |          |          | 19       |
| 22-14               | 19              |              |          |                |          |          | 19       |
| 28-16               | 20              |              |          |                |          |          | 20       |
| 28-11               | 22              |              |          |                | 4        | 18       |          |
| 32-6                | 23              |              | 2        | 3              | 2        | 16       |          |
| 32-13               | 23              |              |          |                | 5        | 18       |          |
| 24-28               | 24              |              |          |                |          |          | 24       |
| 28-12               | 26              |              |          |                |          |          | 26       |
| 36A46               | 27              |              |          |                |          | 27       |          |
| 24A28               | 28              |              |          |                |          |          | 28       |
| 28A63               | 28              |              |          |                | 9        | 19       |          |
| 32-8                | 30              |              |          |                | 6        | 24       |          |
| 36-9                | 31              |              | 1        | 2              | 14       | 14       |          |
| 28-15               | 35              |              |          |                |          |          | 35       |
| 32-7                | 35              |              |          |                | 7        | 28       |          |
| 36-15               | 35              |              |          |                |          |          | 35       |
| 28-21               | 37              |              |          |                |          |          | 37       |
| 36A98               | 39              |              |          | 8              |          |          | 31       |

| Contact arrangement | No. of contacts | Contact size |          |                |          |          |          |
|---------------------|-----------------|--------------|----------|----------------|----------|----------|----------|
|                     |                 | 0<br>500     | 4<br>160 | 8<br>100<br>60 | 12<br>25 | 16<br>15 | 20<br>10 |
| 28A51               | 43              |              |          |                |          |          | 43       |
| 32A47               | 47              |              |          |                |          |          | 47       |
| 36-7                | 47              |              |          |                | 7        | 40       |          |
| 36-8                | 47              |              |          |                | 1        | 46       |          |
| 36-10               | 48              |              |          |                |          |          | 48       |
| 36A34               | 52              |              |          |                |          |          | 52       |
| 32A10               | 54              |              |          |                |          |          | 54       |
| 32A55               | 55              |              |          |                |          |          | 55       |
| 32A69               | 61              |              |          |                |          | 20       | 41       |
| 36A99               | 65              |              |          |                |          | 15       | 50       |

## Box Mounting Receptacle

VG 95234 – Style A

CA 3102E-B and Modifications, see page 9

Receptacle for front panel mounting with square flange.  
Threaded holes in flange not possible.



| VG95234<br>Part no. | Cannon<br>Part no. | d1<br>max. | d2<br>H13 | d3<br>-0,15 | l1<br>±0,3 | l2<br>+0,4 | l3<br>±0,2 | l4<br>±0,3 | Weight <sup>1)</sup><br>g max. |
|---------------------|--------------------|------------|-----------|-------------|------------|------------|------------|------------|--------------------------------|
| VG95234A-10SL       | CA3102E10SL-**-B   | 16,2       | 3,2       | 18,2        | 24,7       | 14,2       | 2,8        | 25,4       | 12                             |
| -                   | CA3102E12S-**-B    | 16,2       | 3,2       | 21,4        | 24,7       | 14,2       | 3,2        | 28,0       | 15                             |
| VG95234A-14S        | CA3102E14S-**-B    | 19,2       | 3,2       | 24,6        | 24,7       | 14,2       | 3,2        | 30,0       | 17                             |
| VG95234A-16S        | CA3102E16S-**-B    | 22,4       | 3,2       | 27,4        | 24,7       | 14,2       | 3,2        | 32,5       | 19                             |
| VG95234A-16         | CA3102E16-**-B     | 22,4       | 3,2       | 27,4        | 33,8       | 19,0       | 3,2        | 32,5       | 22                             |
| VG95234A-18         | CA3102E18-**-B     | 25,6       | 3,2       | 30,8        | 33,8       | 19,0       | 4,0        | 35,0       | 28                             |
| VG95234A-20         | CA3102E20-**-B     | 29,0       | 3,2       | 34,2        | 33,8       | 19,0       | 4,0        | 38,0       | 33                             |
| VG95234A-22         | CA3102E22-**-B     | 32,2       | 3,2       | 37,4        | 33,8       | 19,0       | 4,0        | 41,0       | 38                             |
| VG95234A-24         | CA3102E24-**-B     | 35,3       | 3,7       | 40,9        | 33,8       | 20,6       | 4,0        | 44,5       | 46                             |
| VG95234A-28         | CA3102E28-**-B     | 41,4       | 3,7       | 46,7        | 33,8       | 20,6       | 4,0        | 50,8       | 52                             |
| VG95234A-32         | CA3102E32-**-B     | 47,8       | 4,3       | 53,4        | 33,8       | 22,2       | 4,0        | 57,0       | 64                             |
| VG95234A-36         | CA3102E36-**-B     | 52,6       | 4,3       | 59,6        | 33,8       | 22,2       | 4,0        | 63,5       | 80                             |

<sup>1)</sup> Weight without insulator

CA02L-B designates a receptacle for front panel mounting with solder pin contacts to solder into printed circuits. All pattern drawings upon request. For all other dimensions see above table.

For contact arrangements with #16 and #12 contacts only.



Box Mounting Receptacle

VG95234 Style B1 (with threaded holes in flange)

CA3102-B and Modifications, e.g. -04, -109 or -111

CA3102-B designates a receptacle with square flange for rear panel mounting.

VG95234 Style B2 (with through holes in flange)

CA3102E-B and Modifications, see page 9



Style B2

| VG95234 Part no. | Cannon Part no.    | d1 max. | d2 B1 H13 | B2  | d3 -0,15 | l1 ±0,3 | l2 +0,4 | l3 ±0,2 | l4 ±0,3 | Weight <sup>1)</sup> g max. |
|------------------|--------------------|---------|-----------|-----|----------|---------|---------|---------|---------|-----------------------------|
| VG95234XX-10SL-* | CA3102E10SL-*B-*** | 16,2    | M4        | 3,2 | 18,2     | 24,7    | 18,2    | 2,8     | 25,4    | 14                          |
| -                | CA3102E12S-*B-***  | 16,2    | M4        | 3,2 | 21,4     | 24,7    | 18,2    | 3,2     | 28,0    | 18                          |
| VG95234XX-14S-*  | CA3102E14S-*B-***  | 19,2    | M4        | 3,2 | 24,6     | 24,7    | 18,2    | 3,2     | 30,0    | 21                          |
| CG95234XX-16S-*  | CA3102E16S-*B-***  | 22,4    | M4        | 3,2 | 27,4     | 24,7    | 18,2    | 3,2     | 32,5    | 22                          |
| VG95234XX-16-*   | CA3102E16-*B-***   | 22,4    | M4        | 3,2 | 27,4     | 33,8    | 21,5    | 3,2     | 32,5    | 27                          |
| VG95234XX-18-*   | CA3102E18-*B-***   | 25,6    | M4        | 3,2 | 30,8     | 33,8    | 23,05   | 4,0     | 35,0    | 33                          |
| VG95234XX-20-*   | CA3102E20-*B-***   | 29,0    | M4        | 3,2 | 34,2     | 33,8    | 23,05   | 4,0     | 38,0    | 37                          |
| VG95234XX-22-*   | CA3102E22-*B-***   | 32,2    | M4        | 3,2 | 37,4     | 33,8    | 23,05   | 4,0     | 41,0    | 42                          |
| VG95234XX-24-*   | CA3102E24-*B-***   | 35,3    | M4        | 3,7 | 40,9     | 33,8    | 23,05   | 4,0     | 44,5    | 48                          |
| VG95234XX-28-*   | CA3102E28-*B-***   | 41,4    | M5        | 3,7 | 46,7     | 33,8    | 24,05   | 4,0     | 50,8    | 58                          |
| VG95234XX-32-*   | CA3102E32-*B-***   | 47,8    | M5        | 4,3 | 53,4     | 33,8    | 24,05   | 4,0     | 57,0    | 72                          |
| VG95234XX-36-*   | CA3102E36-*B-***   | 54,1    | M5        | 4,3 | 59,6     | 33,8    | 24,05   | 4,0     | 63,5    | 84                          |

<sup>1)</sup> Weight without insulator

CA20L-B designates a receptacle for rear panel mounting with solder pin contacts to solder into printed circuits. All pattern drawings upon request. For all other dimensions see above table.

For contact arrangements with #16 and #12 contacts only.



Mod. -05

## Thru-Bulkhead Receptacle

VG 95234 Style C1 resp. TBF-B (with threaded holes)  
 VG 95234 Style C2 resp. TBF-B-05 (with flange through holes)

TBF-B designates a bulkhead receptacle with mounting flange.

Modifications see page 9



| VG95234 Part no. | Cannon Part no. | d <sub>2</sub> C1 | C2 H13 | d <sub>2</sub> -0,15 | e ±0,1 | l <sub>1</sub> ±0,7 | l <sub>2</sub> +0,3 | l <sub>3</sub> ±0,2 | l <sub>4</sub> ±0,3 | Weight <sup>1)</sup> g max. |
|------------------|-----------------|-------------------|--------|----------------------|--------|---------------------|---------------------|---------------------|---------------------|-----------------------------|
| VG95234XX-10SL-* | TBF10SL-*B-***  | M4                | 3,2    | 18,2                 | 18,2   | 37,5                | 14,2                | 2,8                 | 25,4                | 17                          |
| -                | TBF12S-*B-***   | M4                | 3,2    | 21,4                 | 20,6   | 37,5                | 14,2                | 3,2                 | 28,0                | 24                          |
| VG95234XX-14S-*  | TBF14S-*B-***   | M4                | 3,2    | 24,6                 | 23,0   | 37,5                | 14,2                | 3,2                 | 30,0                | 29                          |
| CG95234XX-16S-*  | TBF16S-*B-***   | M4                | 3,2    | 27,4                 | 24,6   | 37,5                | 14,2                | 3,2                 | 32,5                | 34                          |
| VG95234XX-16-*   | TBF16-*B-***    | M4                | 3,2    | 27,4                 | 24,6   | 51,4                | 19,0                | 3,2                 | 32,5                | 41                          |
| VG95234XX-18-*   | TBF18-*B-***    | M4                | 3,2    | 30,8                 | 27,0   | 51,4                | 19,0                | 4,0                 | 35,0                | 49                          |
| VG95234XX-20-*   | TBF20-*B-***    | M4                | 3,2    | 34,2                 | 29,4   | 51,4                | 19,0                | 4,0                 | 38,0                | 56                          |
| VG95234XX-22-*   | TBF22-*B-***    | M4                | 3,2    | 37,4                 | 31,8   | 51,4                | 19,0                | 4,0                 | 41,0                | 61                          |
| VG95234XX-24-*   | TBF24-*B-***    | M4                | 3,7    | 40,9                 | 34,9   | 51,4                | 20,6                | 4,0                 | 44,5                | 65                          |
| VG95234XX-28-*   | TBF28-*B-***    | M5                | 3,7    | 46,7                 | 39,7   | 51,4                | 20,6                | 4,0                 | 50,8                | 76                          |
| VG95234XX-32-*   | TBF32-*B-***    | M5                | 4,3    | 53,4                 | 44,5   | 51,4                | 22,2                | 4,0                 | 57,0                | 92                          |
| VG95234XX-36-*   | TBF36-*B-***    | M5                | 4,3    | 59,6                 | 49,2   | 51,4                | 22,2                | 4,0                 | 63,5                | 103                         |

<sup>1)</sup> Weight without insulator, grommets and contacts.

## Straight Plug

CA3106E-B designates a straight plug with endbell, cable clamp and telescoping bushing

VG 95234 Style D resp.  
 CA3106E-B and Modifications, see page 9



| VG95234 Part no. | Cannon Part no.     | d <sub>1</sub> max. | d <sub>2</sub> <sup>2)</sup> max. | l <sub>1</sub> max. | l <sub>2</sub> max. | l <sub>3</sub> max. | l <sub>4</sub> max. | Weight <sup>1)</sup> g max. |
|------------------|---------------------|---------------------|-----------------------------------|---------------------|---------------------|---------------------|---------------------|-----------------------------|
| VG95234D-10SL-*  | CA3106E10SL-**B-*** | 22,8                | 6,5                               | 115                 | 55                  | 22,7                | 22,7                | 30                          |
| -                | CA3106E12S-**B-***  | 26,0                | 6,5                               | 115                 | 55                  | 22,7                | 22,7                | 37                          |
| VG95234D-14S-*   | CA3106E14S-**B-***  | 29,2                | 9,0                               | 115                 | 60                  | 27,5                | 27,5                | 44                          |
| VG95234D-16S-*   | CA3106E16S-**B-***  | 32,0                | 11,0                              | 115                 | 60                  | 30,0                | 30,0                | 54                          |
| VG95234D-16-*    | CA3106E16-**B-***   | 32,0                | 11,0                              | 120                 | 70                  | 30,0                | 30,0                | 62                          |
| VG95234D-18-*    | CA3106E18-**B-***   | 36,5                | 14,2                              | 120                 | 75                  | 33,0                | 33,0                | 70                          |
| VG95234D-20-*    | CA3106E20-**B-***   | 39,9                | 15,8                              | 120                 | 75                  | 37,5                | 37,5                | 85                          |
| VG95234D-22-*    | CA3106E22-**B-***   | 43,1                | 15,8                              | 120                 | 75                  | 37,5                | 37,5                | 92                          |
| VG95234D-24-*    | CA3106E24-**B-***   | 46,6                | 21,4                              | 120                 | 90                  | 43,3                | 43,3                | 127                         |
| VG95234D-28-*    | CA3106E28-**B-***   | 53,4                | 21,4                              | 120                 | 90                  | 48,0                | 43,3                | 154                         |
| VG95234D-32-*    | CA3106E32-**B-***   | 60,1                | 26,7                              | 120                 | 90                  | 55,0                | 51,7                | 199                         |
| VG95234D-36-*    | CA3106E36-**B-***   | 66,3                | 31,7                              | 130                 | 100                 | 58,0                | 58,0                | 260                         |

<sup>1)</sup> Weight without insulator, grommets and contacts.

<sup>2)</sup> For max. cable entry.

# Cannon VG/CA-Bayonet

## Plug 90°

VG 95234 Style E1 (with flex tube)  
CA 3108 F-B and Modifications, see page 9

CA3108E/F designates a plug 90°, which is available with cable clamp and bushing (E) or with flex tube termination (F)

VG 95234 Style E (with cable clamp and telescoping bushing)

CA 3108E-B and Modifications, see page 9



| VG 95 234 Part no. | Cannon Part no.      | d <sub>3</sub> -Thread Style E1 CA3108F | d <sub>1</sub> max. | d <sub>2</sub> <sup>2)</sup> max. | l <sub>1</sub> max. | l <sub>2</sub> max. E | l <sub>3</sub> max. |     | l <sub>4</sub> max. | l <sub>5</sub> | Weight <sup>1)</sup> |     |
|--------------------|----------------------|---|---------------------|-----------------------------------|---------------------|-----------------------|---------------------|-----|---------------------|----------------|----------------------|-----|
|                    |                      |   |                     |                                   |                     |                       | E1                  | E   |                     |                | g                    | E1  |
| VG95234XX-10SL-*   | CA3108X10SL-***B-*** | 5/8-24NEF-2A                            | 22,8                | 6,5                               | 45                  | 42                    | 30                  | 100 | 22,7                | 9,4            | 37                   | 27  |
| -                  | CA3108X12S-***B-***  | 5/8-24NEF-2A                            | 26,0                | 6,5                               | 45                  | 42                    | 30                  | 100 | 22,7                | 9,4            | 45                   | 35  |
| VG95234XX-14S-*    | CA3108X14S-***B-***  | 3/4-20UNEF-2A                           | 29,2                | 9,0                               | 47                  | 42                    | 30                  | 100 | 27,5                | 9,4            | 58                   | 43  |
| VG95234XX-16S-*    | CA3108X16S-***B-***  | 7/8-20UNEF-2A                           | 32,0                | 11,0                              | 48                  | 45                    | 30                  | 100 | 30,0                | 9,4            | 68                   | 48  |
| VG95234XX-16-*     | CA3108X16-***B-***   | 7/8-20UNEF-2A                           | 32,0                | 11,0                              | 57                  | 45                    | 30                  | 100 | 30,0                | 9,4            | 78                   | 58  |
| VG95234XX-18-*     | CA3108X18-***B-***   | 1-20UNEF-2A                             | 36,5                | 14,2                              | 58                  | 53                    | 35                  | 100 | 33,0                | 9,4            | 90                   | 58  |
| VG95234XX-20-*     | CA3108X20-***B-***   | 1 3/16-18UNEF-2A                        | 39,9                | 15,8                              | 61                  | 53                    | 35                  | 100 | 37,5                | 9,4            | 109                  | 74  |
| VG95234XX-22-*     | CA3108X22-***B-***   | 1 3/16-18UNEF-2A                        | 43,1                | 15,8                              | 61                  | 53                    | 35                  | 100 | 37,5                | 9,4            | 113                  | 78  |
| VG95234XX-24-*     | CA3108X24-***B-***   | 1 7/16-18UNEF-2A                        | 46,6                | 21,4                              | 66                  | 58                    | 40                  | 100 | 43,3                | 9,4            | 159                  | 104 |
| VG95234XX-28-*     | CA3108X28-***B-***   | 1 7/16-18UNEF-2A                        | 53,4                | 21,4                              | 66                  | 58                    | 40                  | 100 | 43,3                | 9,4            | 181                  | 126 |
| VG95234XX-32-*     | CA3108X32-***B-***   | 1 3/4 -18UNS-2A                         | 60,1                | 26,7                              | 72                  | 66                    | 45                  | 110 | 51,7                | 11,0           | 245                  | 160 |
| VG95234XX-36-*     | CA3108 36-***B-***   | 2 -18UNS-2A                             | 66,3                | 31,7                              | 75                  | 69                    | 50                  | 110 | 58,0                | 12,6           | 300                  | 190 |

<sup>1)</sup> Weight without insulator, grommets and contacts.

<sup>2)</sup> For max. cable entry.

## Straight Plug

VG 95234 Style F

CA3101E-B designates a cable connection plug with cable clamp and and telescoping bushing

CA 3101E-B and Modifications, see page 9



| VG 95234 Part no.            | Cannon Part no.                   | d <sub>1</sub> max. | d <sub>2</sub> <sup>2)</sup> | d <sub>3</sub> -0,15 | l <sub>1</sub> max. | l <sub>2</sub> ±0,1 | l <sub>3</sub> ±0,2 | l <sub>4</sub> max. | l <sub>5</sub> ±0,2 | l <sub>7</sub> max. | Weight <sup>1)</sup> |
|------------------------------|-----------------------------------|---------------------|------------------------------|----------------------|---------------------|---------------------|---------------------|---------------------|---------------------|---------------------|----------------------|
|                              |                                   |                     |                              |                      |                     |                     |                     |                     |                     |                     | g max.               |
| VG95234F-10SL-*              | CA3101E10SL-***B-***              | 25,2                | 6,5                          | 18,2                 | 57                  | 16,6                | 2,8                 | 120                 | 20,6                | 22,7                | 35                   |
| -                            | CA3101E12S-***B-***               | 27,8                | 6,5                          | 21,4                 | 57                  | 16,6                | 3,2                 | 120                 | 23,6                | 22,7                | 43                   |
| VG95234F-14S-*               | CA3101E14S-***B-***               | 29,8                | 9,0                          | 24,6                 | 59                  | 16,6                | 3,2                 | 120                 | 25,4                | 27,5                | 50                   |
| VG95234F-16S-*               | CA3101E16S-***B-***               | 32,3                | 11,0                         | 27,4                 | 60                  | 16,6                | 3,2                 | 120                 | 28,6                | 30,0                | 60                   |
| VG95234F-16-*                | CA3101E16-***B-***                | 32,3                | 11,0                         | 27,4                 | 68                  | 23,9                | 3,2                 | 125                 | 28,6                | 30,0                | 65                   |
| VG95234F-18-*                | CA3101E18-***B-***                | 34,8                | 14,2                         | 30,8                 | 72                  | 23,9                | 4,0                 | 125                 | 31,7                | 33,0                | 80                   |
| VG95234F-20-*                | CA3101E20-***B-***                | 37,8                | 15,8                         | 34,2                 | 72                  | 23,9                | 4,0                 | 125                 | 34,9                | 37,5                | 95                   |
| VG95234F-22-*                | CA3101E22-***B-***                | 41,1                | 15,8                         | 37,4                 | 72                  | 23,9                | 4,0                 | 125                 | 38,1                | 37,5                | 105                  |
| VG95234F-24-*                | CA3101E24-***B-***                | 44,6                | 21,4                         | 40,9                 | 78                  | 23,9                | 4,0                 | 125                 | 41,3                | 43,3                | 140                  |
| VG95234F-28-*                | CA3101E28-***B-***                | 50,9                | 21,4                         | 46,7                 | 79                  | 23,9                | 4,0                 | 125                 | 47,6                | 43,3                | 160                  |
| VG95234F-32-*                | CA3101E32-***B-***                | 57,1                | 26,7                         | 53,4                 | 78                  | 23,9                | 4,0                 | 125                 | 54,0                | 51,7                | 205                  |
| VG95234F-36 <sup>*)</sup> -* | CA3101E36 <sup>*)</sup> -***B-*** | 63,6                | 31,7                         | 59,6                 | 78                  | 23,9                | 4,0                 | 135                 | 60,6                | 58,0                | 270                  |

<sup>1)</sup> Weight without insulator, grommets and contacts.

<sup>2)</sup> For max. cable entry.

<sup>\*)</sup> For contact insert 36-5P a support washer is included.

## Straight Plug

### VG95234 – Style G

CA3106E-B, -02, -03 or -06 designates a straight plug with adapter for heat shrinkable boots

CA3106E-B and Modifications, see page 9



| VG 95234 Part no. | Cannon Part no.     | d1 max. | d2 ±0,2 | d3 ±0,2 | d4 max. | d5 min. | l1 max. | l2 ±0,5 | Weight <sup>1)</sup> g max. |
|-------------------|---------------------|---------|---------|---------|---------|---------|---------|---------|-----------------------------|
| VG95234G-10SL-*   | CA3106E10SL-**B-*** | 22,8    | 17,0    | 15,5    | 13,3    | 7,7     | 50      | 11,7    | 24                          |
| -                 | CA3106E12S-**B-***  | 26,0    | 17,8    | 15,5    | 13,3    | 7,9     | 50      | 11,7    | 35                          |
| VG95234G-14S-*    | CA3106E14S-**B-***  | 29,2    | 20,1    | 19,1    | 17,0    | 10,6    | 50      | 11,7    | 41                          |
| VG95234G-16S-*    | CA3106E16S-**B-***  | 32,0    | 23,5    | 23,9    | 21,9    | 13,5    | 50      | 11,7    | 51                          |
| VG95234G-16-*     | CA3106E16-**B-***   | 32,0    | 23,5    | 23,9    | 21,9    | 13,5    | 60      | 11,7    | 58                          |
| VG95234G-18-*     | CA3106E18-**B-***   | 36,5    | 26,5    | 23,9    | 21,9    | 14,6    | 60      | 11,7    | 65                          |
| VG95234G-20-*     | CA3106E20-**B-***   | 39,9    | 30,2    | 29,6    | 26,2    | 18,7    | 65      | 12,7    | 75                          |
| VG95234G-22-*     | CA3106E22-**B-***   | 43,1    | 33,6    | 29,6    | 26,2    | 20,8    | 65      | 12,7    | 80                          |
| VG95234G-24-*     | CA3106E24-**B-***   | 46,6    | 38,1    | 37,8    | 34,5    | 24,6    | 65      | 12,7    | 95                          |
| VG95234G-28-*     | CA3106E28-**B-***   | 53,4    | 41,4    | 37,8    | 34,5    | 27,0    | 65      | 12,7    | 120                         |
| VG95234G-32-*     | CA3106E32-**B-***   | 60,1    | 48,6    | 47,8    | 43,6    | 33,3    | 70      | 15,2    | 165                         |
| VG95234G-36-*     | CA3106E36-**B-***   | 66,3    | 54,8    | 47,8    | 43,6    | 38,5    | 80      | 15,2    | 180                         |

<sup>1)</sup> Weight without insulator, grommets and contacts.

## Straight Plug

### VG95234 Style H

CA3106-F-B designates a straight plug for flex tube

CA3106-B and Modifications, see page 9



| VG 95234 Part no. | Cannon Part no.     | d3-Thread        | d1 max. | d2 <sup>2)</sup> | l1 max. | l2 min. | Weight <sup>1)</sup> g max. |
|-------------------|---------------------|------------------|---------|------------------|---------|---------|-----------------------------|
| VG95234H-10SL-*   | CA3106F10SL-**B-*** | 5/8-24NEF-2A     | 22,8    | 8,2              | 50      | 9,5     | 21                          |
| -                 | CA3106F12S-**B-***  | 5/8-24NEF-2A     | 26,0    | 8,2              | 50      | 9,5     | 29                          |
| VG95234H-14S-*    | CA3106F14S-**B-***  | 3/4-20UNEF-2A    | 29,2    | 11,1             | 50      | 9,5     | 33                          |
| VG95234H-16S-*    | CA3106F16S-**B-***  | 7/8-20UNEF-2A    | 32,0    | 14,3             | 50      | 9,5     | 42                          |
| VG95234H-16-*     | CA3106F16-**B-***   | 7/8-20UNEF-2A    | 32,0    | 14,3             | 60      | 9,5     | 51                          |
| VG95234H-18-*     | CA3106F18-**B-***   | 1-20UNEF-2A      | 36,5    | 16,7             | 60      | 9,5     | 59                          |
| VG95234H-20-*     | CA3106F20-**B-***   | 1 3/16-18UNEF-2A | 39,9    | 19,8             | 60      | 9,5     | 59                          |
| VG96234H-22-*     | CA3106F22-**B-***   | 1 3/16-18UNEF-2A | 43,1    | 19,8             | 60      | 9,5     | 62                          |
| VG95234H-24-*     | CA3106F24-**B-***   | 1 7/16-18UNEF-2A | 46,6    | 25,4             | 65      | 9,5     | 84                          |
| VG95234H-28-*     | CA3106F28-**B-***   | 1 7/16-18UNEF-2A | 53,4    | 27,0             | 65      | 9,5     | 100                         |
| VG95234H-32-*     | CA3106F32-**B-***   | 1 3/4-18UNS-2A   | 60,1    | 32,5             | 65      | 11,0    | 116                         |
| VG95234H-36-*     | CA3106F36-**B-***   | 2-18UNS-2A       | 66,3    | 35,7             | 80      | 11,8    | 142                         |

<sup>1)</sup> Weight without insulator, grommets and contacts.

<sup>2)</sup> For max. cable entry.



## Wall Mounting Receptacle

for rear mounting

VG95234 Style J<sub>1</sub> (with threaded holes in flange)

VG95234 Style J<sub>2</sub> (with through holes in flange)

CA3100E-B and Modifications e g -05  
(with through holes)

CA3100E-B designates a wall mounting  
receptacle with cable clamp and telescoping  
bushing

CA3100E-B and Modifications e g -01, -F80  
(for ordered contacts)

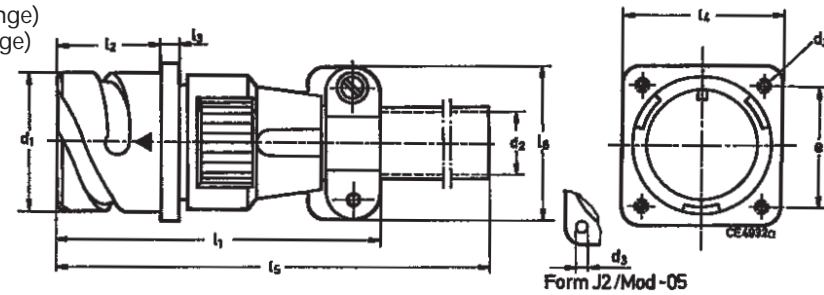

| VG95234<br>Part no. | Cannon<br>Part no.   | d <sub>1</sub><br>-0,15 | d <sub>2</sub> <sup>1)</sup> | J <sub>1</sub> | d <sub>3</sub><br>J <sub>2</sub> | l <sub>1</sub><br>max. | l <sub>2</sub><br>+0,4 | l <sub>3</sub><br>±0,2 | l <sub>4</sub><br>±0,3 | l <sub>5</sub><br>max. |
|---------------------|----------------------|-------------------------|------------------------------|----------------|----------------------------------|------------------------|------------------------|------------------------|------------------------|------------------------|
| VG95234*XX-10SL-*   | CA3100E10SL-**-B-*** | 18,2                    | 6,5                          | M4             | 3,2                              | 57                     | 18,2                   | 2,8                    | 25,4                   | 120                    |
| -                   | CA3100E12S-**-B-***  | 21,4                    | 6,5                          | M4             | 3,2                              | 57                     | 18,2                   | 3,2                    | 28,0                   | 120                    |
| VG95234*XX-14S-*    | CA3100E14S-**-B-***  | 24,6                    | 9,0                          | M4             | 3,2                              | 59                     | 18,2                   | 3,2                    | 30,0                   | 120                    |
| VG95234*XX-16S-*    | CA3100E16S-**-B-***  | 27,4                    | 11,0                         | M4             | 3,2                              | 60                     | 18,2                   | 3,2                    | 32,5                   | 120                    |
| VG95234*XX-16-*     | CA3100E16-**-B-***   | 27,4                    | 11,0                         | M4             | 3,2                              | 68                     | 21,5                   | 3,2                    | 32,5                   | 125                    |
| VG95234*XX-18-*     | CA3100E18-**-B-***   | 30,8                    | 14,2                         | M4             | 3,2                              | 72                     | 23,05                  | 4,0                    | 35,0                   | 125                    |
| VG95234*XX-20-*     | CA3100E20-**-B-***   | 34,2                    | 15,8                         | M4             | 3,2                              | 72                     | 23,05                  | 4,0                    | 38,0                   | 125                    |
| VG95234*XX-22-*     | CA3100E22-**-B-***   | 37,4                    | 15,8                         | M4             | 3,2                              | 72                     | 23,05                  | 4,0                    | 41,0                   | 125                    |
| VG95234*XX-24-*     | CA3100E24-**-B-***   | 40,9                    | 21,4                         | M4             | 3,7                              | 78                     | 23,05                  | 4,0                    | 44,5                   | 125                    |
| VG95234*XX-28-*     | CA3100E28-**-B-***   | 46,7                    | 21,4                         | M5             | 3,7                              | 79                     | 24,05                  | 4,0                    | 50,8                   | 125                    |
| VG95234*XX-32-*     | CA3100E32-**-B-***   | 53,4                    | 26,7                         | M5             | 4,3                              | 78                     | 24,05                  | 4,0                    | 57,0                   | 125                    |
| VG95234*XX-36-*     | CA3100E36-**-B-***   | 59,6                    | 31,7                         | M5             | 4,3                              | 78                     | 24,05                  | 4,0                    | 63,5                   | 135                    |

<sup>1)</sup> For max. cable entry.

## Plug 90°, Shielded

VG95234 Style K

CA3108F-B-13, -14 or -15 designates a shielded plug  
with 90° endbell for flex tube

CA3108F and Modifications, see page 9

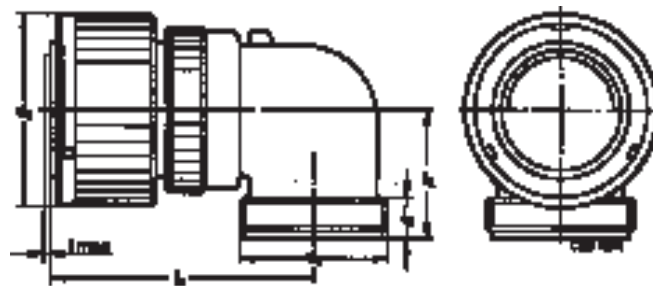

| VG96234<br>Part no. | Cannon<br>Part no.   | d <sub>3</sub> -Thread | d <sub>1</sub><br>max. | l <sub>1</sub><br>max. | l <sub>2</sub><br>max. | l <sub>3</sub><br>min. | Weight <sup>1)</sup><br>g max. |
|---------------------|----------------------|------------------------|------------------------|------------------------|------------------------|------------------------|--------------------------------|
| -                   | CA3108F10SL-**-B-*** | 5/8-24UNEF-2A          | 22,8                   | 45                     | 22                     | 9,4                    | 27                             |
| VG95234K-12S-*      | CA3108F12S-**-B-***  | 5/8-24UNEF-2A          | 26,0                   | 45                     | 22                     | 9,4                    | 35                             |
| VG95234K-14S-*      | CA3108F14S-**-B-***  | 3/4-20UNEF-2A          | 29,2                   | 47                     | 24                     | 9,4                    | 43                             |
| VG95234K-16S-*      | CA3108F16S-**-B-***  | 7/8-20UNEF-2A          | 32,0                   | 48                     | 25                     | 9,4                    | 48                             |
| VG95234K-16-*       | CA3108F16-**-B-***   | 7/8-20UNEF-2A          | 32,0                   | 57                     | 25                     | 9,4                    | 58                             |
| VG95234K-18-*       | CA3108F18-**-B-***   | 1-20UNEF-2A            | 36,5                   | 58                     | 27                     | 9,4                    | 58                             |
| VG95234K-20-*       | CA3108F20-**-B-***   | 1 3/16-18UNEF-2A       | 39,9                   | 61                     | 29                     | 9,4                    | 74                             |
| VG95234K-22-*       | CA3108F22-**-B-***   | 1 3/16-18UNEF-2A       | 43,1                   | 61                     | 30                     | 9,4                    | 78                             |
| VG95234K-24-*       | CA3108F24-**-B-***   | 1 7/16-18UNEF-2A       | 46,6                   | 66                     | 32                     | 9,4                    | 104                            |
| VG95234K-28-*       | CA3108F28-**-B-***   | 1 7/16-18UNEF-2A       | 53,4                   | 66                     | 34                     | 9,4                    | 126                            |
| CG95234K-32-*       | CA3108F32-**-B-***   | 1 3/4-18UNS-2A         | 60,1                   | 72                     | 39,5                   | 11,0                   | 160                            |
| VG95234K-36-*       | CA3108F36-**-B-***   | 2-18UNS-2A             | 66,3                   | 75                     | 45                     | 12,6                   | 190                            |

<sup>1)</sup> Weight without insulator, grommets and contacts.

## Straight Plug, shielded

### VG95234 Style L

CA3106F-B-13, -14 or -15 designates a straight plug with endbell for flex tube

CA3106F-B and Modifications, see page 9



| VG95234 Part no. | Cannon Part no.      | d <sub>3</sub> -Thread | d <sub>1</sub> | d <sub>2</sub> <sup>2)</sup> max. | l <sub>1</sub> | l <sub>2</sub> min. | Weight <sup>1)</sup> g max. |
|------------------|----------------------|------------------------|----------------|-----------------------------------|----------------|---------------------|-----------------------------|
| VG95234L-10SL-*  | CA3106F10SL-**-B-*** | 5/8-24UNEF-2A          | 22,8           | 8,2                               | 50             | 9,5                 | 21                          |
| VG95234L-12S-*   | CA3106F12S-**-B-***  | 5/8-24UNEF-2A          | 26,0           | 8,2                               | 50             | 9,5                 | 29                          |
| VG95234L-14S-*   | CA3106F14S-**-B-***  | 3/4-20UNEF-2A          | 29,2           | 11,1                              | 50             | 9,5                 | 33                          |
| VG95234L-16S-*   | CA3106F16S-**-B-***  | 7/8-20UNEF-2A          | 32,0           | 14,3                              | 50             | 9,5                 | 42                          |
| VG95234L-16-*    | CA3106F-16-**-B-***  | 7/8-20UNEF-2A          | 32,0           | 14,3                              | 60             | 9,5                 | 51                          |
| VG95234L-18-*    | CA3106F-18-**-B-***  | 1-20UNEF-2A            | 36,5           | 16,7                              | 60             | 9,5                 | 59                          |
| VG95234L-20-*    | CA3106F-20-**-B-***  | 1 3/16-18UNEF-2A       | 39,9           | 19,8                              | 60             | 9,5                 | 58                          |
| VG95234L-22-*    | CA3106F-22-**-B-***  | 1 3/16-18UNEF-2A       | 43,1           | 19,8                              | 60             | 9,5                 | 62                          |
| VG95234L-24-*    | CA3106F-24-**-B-***  | 1 7/16-18UNEF-2A       | 46,6           | 25,4                              | 65             | 9,5                 | 84                          |
| VG95234L-28-*    | CA3106F-28-**-B-***  | 1 7/16-18UNEF-2A       | 53,4           | 27,0                              | 65             | 9,5                 | 100                         |
| VG95234L-32-*    | CA3106F-32-**-B-***  | 1 3/4-18UNS-2A         | 60,1           | 32,5                              | 65             | 11,0                | 116                         |
| VG95234L-36-*    | CA3106F-36-**-B-***  | 2-18UNS-2A             | 66,3           | 35,7                              | 80             | 11,8                | 142                         |

<sup>1)</sup> Weight without insulator, grommets and contacts.

<sup>2)</sup> For max. cable entry.

## Straight Plug, shielded

### VG95234 Style M

CA3106E-B-13, -14 or -15 designates a straight, shielded plug with endbell for shielded braids, and heat shrinkable boots

CA3106E-B and Modifications, see page 9



| VG95234 Part no. | Cannon Part no.      | d <sub>1</sub> max. | d <sub>2</sub> <sup>2)</sup> min. | d <sub>3</sub> ±0,5 | d <sub>4</sub> max. | l <sub>1</sub> max. | l <sub>2</sub> +1 | l <sub>3</sub> ±0,5 | Weight <sup>1)</sup> g max. |
|------------------|----------------------|---------------------|-----------------------------------|---------------------|---------------------|---------------------|-------------------|---------------------|-----------------------------|
| VG95234M-10SL-*  | CA3106E10SL-**-B-*** | 22,8                | 7,7                               | 18,5                | 16,3                | 55,0                | 17,0              | 7,0                 | 40                          |
| -                | CA3106E12S-**-B-***  | 26,0                | 9,3                               | 20,0                | 17,0                | 55,0                | 17,0              | 7,0                 | 42                          |
| VG95234M-14S-*   | CA3106E14S-**-B-***  | 29,2                | 10,6                              | 22,0                | 20,0                | 55,0                | 17,0              | 7,0                 | 45                          |
| VG95234M-16S-*   | CA3106E16S-**-B-***  | 32,0                | 13,5                              | 25,0                | 23,0                | 60,0                | 18,0              | 8,0                 | 55                          |
| VG95234M-16-*    | CA3106E16-**-B-***   | 32,0                | 13,5                              | 25,0                | 23,0                | 70,0                | 18,0              | 8,0                 | 65                          |
| VG95234M-18-*    | CA3106E18-**-B-***   | 36,5                | 14,6                              | 28,0                | 24,5                | 70,0                | 18,0              | 8,0                 | 75                          |
| VG95234M-20-*    | CA3106E20-**-B-***   | 39,9                | 18,5                              | 32,0                | 28,5                | 70,0                | 18,0              | 10,0                | 85                          |
| VG95234M-22-*    | CA3106E22-**-B-***   | 43,1                | 20,8                              | 34,0                | 30,5                | 70,0                | 18,0              | 10,0                | 100                         |
| VG95234M-24-*    | CA3106E24-**-B-***   | 46,6                | 24,6                              | 38,0                | 34,5                | 70,0                | 18,0              | 10,0                | 115                         |
| VG95234M-28-*    | CA3106E28-**-B-***   | 53,4                | 27,0                              | 41,0                | 37,5                | 70,0                | 18,0              | 10,0                | 130                         |
| VG95234M-32-*    | CA3106E32-**-B-***   | 60,1                | 33,3                              | 48,0                | 44,0                | 70,0                | 18,0              | 10,0                | 170                         |
| VG95234M-36-*    | CA3106E36-**-B-***   | 66,3                | 38,5                              | 55,0                | 51,0                | 80,0                | 18,0              | 10,0                | 190                         |

<sup>1)</sup> Weight without insulator, grommets and contacts.

<sup>2)</sup> For max. cable entry.

## Wall Mounting Receptacle

VG95234 Style N1 (with threaded holes in flange)  
 VG95234 Style N2 (with through holes in flange)

CA3100E-B, -13, -14 or -15, -05-13, -05-14 or -05-15  
 designates a shielded receptacle with endbell for  
 shielded braids, and also for heat shrinkable boots

CA3100E-B and Modifications, see page 9



| VG95234<br>Part no. | Cannon<br>Part no.   | d <sub>1</sub> | d <sub>2</sub><br>Thread H13 |     | d <sub>3</sub><br>±0,5 | d <sub>4</sub> <sup>2)</sup><br>min. | d <sub>5</sub><br>max. | e<br>±0,1 | l <sub>1</sub><br>max. | l <sub>2</sub><br>+0,4 | l <sub>3</sub><br>±0,2 | l <sub>4</sub><br>+0,3 | Weight <sup>1)</sup><br>g<br>max. |
|---------------------|----------------------|----------------|------------------------------|-----|------------------------|--------------------------------------|------------------------|-----------|------------------------|------------------------|------------------------|------------------------|-----------------------------------|
| VG95234*XX-10SL-*   | CA3100E10SL-**-B-*** | 18,2           | M4                           | 3,2 | 18,5                   | 7,7                                  | 16,3                   | 18,2      | 55                     | 18,2                   | 2,8                    | 25,4                   | 45                                |
| VG95234*XX-14S-*    | CA3100E14S-**-B-***  | 24,6           | M4                           | 3,2 | 22,0                   | 10,6                                 | 20,0                   | 23,0      | 58                     | 18,2                   | 3,2                    | 30,0                   | 55                                |
| VG95234*XX-16S-*    | CA3100E16S-**-B-***  | 27,4           | M4                           | 3,2 | 25,0                   | 13,5                                 | 23,0                   | 24,6      | 70                     | 18,2                   | 3,2                    | 32,5                   | 65                                |
| VG95234*XX-16-*     | CA3100E16-**-B-***   | 27,4           | M4                           | 3,2 | 25,0                   | 13,5                                 | 23,0                   | 24,6      | 70                     | 21,5                   | 3,2                    | 32,5                   | 75                                |
| VG95234*XX-18-*     | CA3100E18-**-B-***   | 30,8           | M4                           | 3,2 | 28,0                   | 14,6                                 | 24,5                   | 27,0      | 70                     | 23,05                  | 4,0                    | 35,0                   | 85                                |
| VG95234*XX-20-*     | CA3100E20-**-B-***   | 34,2           | M4                           | 3,2 | 32,0                   | 18,5                                 | 28,5                   | 29,4      | 70                     | 23,05                  | 4,0                    | 38,4                   | 95                                |
| VG95234*XX-22-*     | CA3100E22-**-B-***   | 37,4           | M4                           | 3,2 | 34,0                   | 20,8                                 | 30,5                   | 31,8      | 70                     | 23,05                  | 4,0                    | 41,0                   | 105                               |
| VG95234*XX-24-*     | CA3100E24-**-B-***   | 40,9           | M4                           | 3,7 | 38,0                   | 24,6                                 | 34,5                   | 34,9      | 70                     | 23,05                  | 4,0                    | 44,5                   | 120                               |
| VG95234*XX-28-*     | CA3100E28-**-B-***   | 46,7           | M5                           | 3,7 | 41,0                   | 27,0                                 | 37,5                   | 39,7      | 70                     | 24,05                  | 4,0                    | 50,8                   | 150                               |
| VG95234*XX-32-*     | CA3100E32-**-B-***   | 53,4           | M5                           | 4,3 | 48,0                   | 33,3                                 | 44,0                   | 44,5      | 75                     | 24,05                  | 4,0                    | 57,0                   | 190                               |
| VG95234*XX-36-*     | CA3100E36-**-B-***   | 59,6           | M5                           | 4,3 | 55,0                   | 38,5                                 | 51,0                   | 49,2      | 85                     | 24,05                  | 4,0                    | 63,5                   | 220                               |

<sup>1)</sup> Weight without insulator, grommets and contacts.

<sup>2)</sup> For max. cable entry.

## Straight Plug

VG95234 Style R1 (for system cable according to  
 MTV6145-005)

CA3106E-B, -32-DXX designates  
 a straight plug, shielded, with endbell for system  
 cable acc. MTV6145-005.

(DXX means cable entry diameter)

CA3106E-B and Modification, see page 9



| VG95234<br>Part no. | Cannon<br>Part no.     | d <sub>1</sub> | d <sub>3</sub> | d <sub>4</sub> | d <sub>5</sub> | d <sub>6</sub> | d <sub>7</sub> | l <sub>1</sub> | l <sub>2</sub> | Weight <sup>1)</sup><br>g<br>max. |
|---------------------|------------------------|----------------|----------------|----------------|----------------|----------------|----------------|----------------|----------------|-----------------------------------|
| VG95234R1-14S       | CA3106E14S-**-B-32     | 29,2           | 10,0           | 14,0           | M 20x1         | 21,0           | 23,5           | 57             | 21,0           | 50                                |
| VG95234R1-16S       | CA3106E16S-**-B-32     | 32,0           | 10,0           | 14,0           | M 20x1         | 21,0           | 23,5           | 57             | 21,0           | 60                                |
| -                   | CA3106E16S-**-B-32-D12 | 32,0           | 12,2           | 16,0           | M 22x1         | 23,0           | 25,5           | 57             | 21,0           | 60                                |
| VG95234R1-18        | CA3106E18-**-B-32      | 36,5           | 12,2           | 16,0           | M 22x1         | 23,0           | 25,5           | 66             | 21,0           | 80                                |
| VG95234R1-20        | CA3106E20-**-B-32      | 39,9           | 13,4           | 18,0           | M 27x1         | 26,6           | 30,5           | 68             | 21,0           | 90                                |
| -                   | CA3106E20-**-B-32-D19  | 39,9           | 19,6           | 22,6           | M 27x1         | 31,5           | 35,5           | 68             | 21,0           | 90                                |
| VG95234R1-28        | CA3106E28-**-B-32      | 53,4           | 19,0           | 26,0           | M 35x1         | 37,6           | 41,5           | 76             | 26,0           | 135                               |
| -                   | CA3106E28-**-B-32-D22  | 53,4           | 23,0           | 26,5           | M 35x1         | 37,6           | 41,5           | 76             | 26,0           | 135                               |
| VG95234R1-32        | CA3106E32-**-B-32      | 60,1           | 21,0           | 26,5           | M 35x1         | 37,5           | 41,5           | 79             | 26,0           | 175                               |
| -                   | CA3106E32-**-B-32-D22  | 60,3           | 23,0           | 26,5           | M 35x1         | 37,5           | 41,5           | 82             | 26,0           | 200                               |
| -                   | CA3106E36-**-B-32-D22  | 66,3           | 23,0           | 26,5           | M 42x1         | 37,5           | 41,5           | 82             | 26,0           | 200                               |
| -                   | CA3106E36-**-B-32-D26  | 66,3           | 27,0           | 33,0           | M 42x1         | 45,0           | 49,7           | 82             | 26,0           | 200                               |

<sup>1)</sup> Weight without insulator, grommets and contacts.

## Wall Mounting Receptacle

**VG95234 Style S1 (with thread holes in flange)**

CA3100E-B, -32, -32-05 designates a wall mounting receptacle, shielded, with endbell for system cable acc. MTV 6145-005.

CA3100E-B and Modification, see page 9



| VG95234 Part no. | Cannon Part no.     | d <sub>1</sub><br>-0,15 | d <sub>2</sub><br>Thread H13 | d <sub>3</sub> | d <sub>4</sub><br>±0,3 | d <sub>5</sub> | e<br>±0,1 | l <sub>1</sub><br>max. | l <sub>2</sub><br>±0,4 | l <sub>3</sub><br>±0,2 | l <sub>4</sub><br>±0,3 | l <sub>5</sub><br>max. |      |
|------------------|---------------------|-------------------------|------------------------------|----------------|------------------------|----------------|-----------|------------------------|------------------------|------------------------|------------------------|------------------------|------|
| VG95234S1-14S    | CA3100E14S-**-B-*** | 24,6                    | M4                           | 3,2            | 21,0                   | 23,5           | 10,0      | 23,0                   | 61                     | 18,2                   | 3,2                    | 30,0                   | 21,0 |
| VG95234S1-16S    | CA3100E16S-**-B-*** | 27,4                    | M4                           | 3,2            | 21,0                   | 23,5           | 10,0      | 24,6                   | 61                     | 18,2                   | 3,2                    | 32,5                   | 21,0 |
| VG95234S1-18     | CA3100E18-**-B-***  | 30,8                    | M4                           | 3,2            | 23,0                   | 25,5           | 12,2      | 27,0                   | 70                     | 23,05                  | 4,0                    | 35,0                   | 21,0 |
| VG95234S1-20     | CA3100E20-**-B-***  | 34,2                    | M4                           | 3,2            | 26,6                   | 30,5           | 13,4      | 29,4                   | 72                     | 23,05                  | 4,0                    | 38,0                   | 21,0 |
| VG95234S1-28     | CA3100E28-**-B-***  | 46,7                    | M5                           | 3,7            | 37,5                   | 41,5           | 19,0      | 39,7                   | 78                     | 24,05                  | 4,0                    | 50,8                   | 26,0 |
| VG95234S1-32     | CA3100E32-**-B-***  | 53,4                    | M5                           | 4,3            | 37,5                   | 41,5           | 21,0      | 44,5                   | 81                     | 24,05                  | 4,0                    | 57,0                   | 26,0 |

## Straight Plug, Shielded with Adapter for Heat Shrink Boots

**VG95234 Style T**

CA3106E-B, 02-41, 03-41, 06-41 designates a straight plug, shielded, with endbell for heat shrink boot.

CA3106E-B and Modification, see page 9

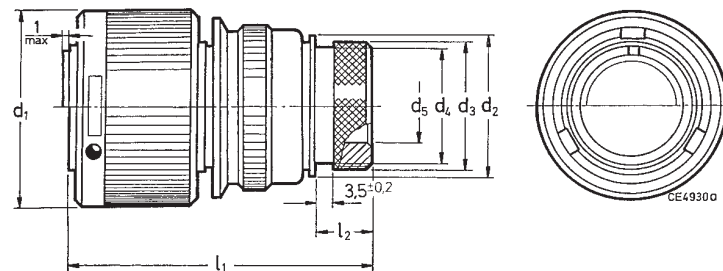

| VG 95234 Part no. | Cannon Part no.      | d <sub>1</sub><br>max. | d <sub>2</sub><br>±0,2 | d <sub>3</sub><br>±0,2 | d <sub>4</sub><br>max. | d <sub>5</sub><br>min. | l <sub>1</sub><br>max. | l <sub>2</sub><br>±0,5 | Weight <sup>1)</sup><br>g max. |
|-------------------|----------------------|------------------------|------------------------|------------------------|------------------------|------------------------|------------------------|------------------------|--------------------------------|
| VG95234T-10SL-*   | CA3106E10SL-**-B-*** | 22,8                   | 17,0                   | 15,5                   | 13,3                   | 7,7                    | 50                     | 11,7                   | 24                             |
| -                 | CA3106E12S-**-B-***  | 26,0                   | 17,8                   | 15,5                   | 13,3                   | 7,9                    | 50                     | 11,7                   | 35                             |
| VG95234T-14S-*    | CA3106E14S-**-B-***  | 29,2                   | 20,1                   | 19,1                   | 17,0                   | 10,6                   | 50                     | 11,7                   | 41                             |
| VG95234T-16S-*    | CA3106E16S-**-B-***  | 32,0                   | 23,5                   | 23,9                   | 21,9                   | 13,5                   | 50                     | 11,7                   | 51                             |
| VG95234T-16-*     | CA3106E16-**-B-***   | 32,0                   | 23,5                   | 23,9                   | 21,9                   | 13,5                   | 60                     | 11,7                   | 58                             |
| VG95234T-18-*     | CA3106E18-**-B-***   | 36,5                   | 26,5                   | 23,9                   | 21,9                   | 14,6                   | 60                     | 11,7                   | 65                             |
| VG95234T-20-*     | CA3106E20-**-B-***   | 39,9                   | 30,2                   | 29,6                   | 26,2                   | 18,7                   | 65                     | 12,7                   | 75                             |
| VG95234T-22-*     | CA3106E22-**-B-***   | 43,1                   | 33,6                   | 29,6                   | 26,2                   | 20,8                   | 65                     | 12,7                   | 80                             |
| VG95234T-24-*     | CA3106E24-**-B-***   | 46,6                   | 38,1                   | 37,8                   | 34,5                   | 24,6                   | 65                     | 12,7                   | 95                             |
| VG95234T-28-*     | CA3106E28-**-B-***   | 53,4                   | 41,4                   | 37,8                   | 34,5                   | 27,0                   | 65                     | 12,7                   | 120                            |
| VG95234T-32-*     | CA3106E32-**-B-***   | 60,1                   | 48,6                   | 47,8                   | 43,6                   | 33,3                   | 70                     | 15,2                   | 165                            |
| VG95234T-36-*     | CA3106E36-**-B-***   | 66,3                   | 54,8                   | 47,8                   | 43,6                   | 38,5                   | 80                     | 15,2                   | 180                            |

<sup>1)</sup> Weight without insulator, grommets and contacts.

## Wall Mounting Receptacle

VG95234 Style U1 (with threaded holes in flange)  
VG95234 Style U2 (with through holes in flange)

CA3100E-B-02-05, -03-05 or -05-06, -02-03 or -06 designates a wall mounting receptacle with adapter for heat shrinkable boots

CA3100E-B and Modifications, see page 9



| VG95234 Part no. | Cannon Part no.      | d <sub>1</sub><br>-0,15 | d <sub>2</sub><br>Thread H13 | d <sub>3</sub><br>±0,2 | d <sub>4</sub> | d <sub>5</sub><br>max. | e<br>±0,1 | l <sub>1</sub><br>max. | l <sub>2</sub><br>+0,4 | l <sub>3</sub><br>±0,2 | l <sub>4</sub><br>±0,3 | Weight <sup>1)</sup><br>g max. |     |
|------------------|----------------------|-------------------------|------------------------------|------------------------|----------------|------------------------|-----------|------------------------|------------------------|------------------------|------------------------|--------------------------------|-----|
| VG95234U1-10SL-* | CA3100E10SL-**-B-*** | 18,2                    | M4                           | 3,2                    | 15,5           | 7,7                    | 13,3      | 18,2                   | 57                     | 18,2                   | 2,8                    | 25,4                           | 35  |
| –                | CA3100E12S-**-B-***  | 21,4                    | M4                           | 3,2                    | 15,5           | 7,9                    | 13,3      | 20,6                   | 57                     | 18,2                   | 3,2                    | 28,0                           | 45  |
| VG95234U1-14S-*  | CA3100E14S-**-B-***  | 24,6                    | M4                           | 3,2                    | 19,1           | 10,6                   | 17,0      | 23,0                   | 57                     | 18,2                   | 3,2                    | 30,0                           | 50  |
| VG95234U1-16S-*  | CA3100E16S-**-B-***  | 27,4                    | M4                           | 3,2                    | 23,9           | 13,5                   | 21,9      | 24,6                   | 57                     | 18,2                   | 3,2                    | 32,5                           | 60  |
| VG95234U1-16-*   | CA3100E16-**-B-***   | 27,4                    | M4                           | 3,2                    | 23,9           | 13,5                   | 21,9      | 24,6                   | 63                     | 21,5                   | 3,2                    | 32,5                           | 65  |
| VG95234U1-18-*   | CA3100E18-**-B-***   | 30,8                    | M4                           | 3,2                    | 23,9           | 14,6                   | 21,9      | 27,0                   | 65                     | 23,05                  | 4,0                    | 35,0                           | 80  |
| VG95234U1-20-*   | CA3100E20-**-B-***   | 34,2                    | M4                           | 3,2                    | 29,6           | 18,7                   | 26,2      | 29,4                   | 68                     | 23,05                  | 4,0                    | 38,0                           | 95  |
| VG95234U1-22-*   | CA3100E22-**-B-***   | 37,4                    | M4                           | 3,2                    | 29,6           | 20,8                   | 26,2      | 31,8                   | 68                     | 23,05                  | 4,0                    | 41,0                           | 105 |
| VG95234U1-24-*   | CA3100E24-**-B-***   | 40,9                    | M4                           | 3,7                    | 37,8           | 24,6                   | 34,5      | 34,9                   | 70                     | 23,05                  | 4,0                    | 44,5                           | 140 |
| VG95234U1-28-*   | CA3100E28-**-B-***   | 46,7                    | M5                           | 3,7                    | 37,8           | 27,0                   | 34,5      | 39,7                   | 71                     | 24,05                  | 4,0                    | 50,8                           | 160 |
| VG95234U1-32-*   | CA3100E32-**-B-***   | 53,4                    | M5                           | 4,3                    | 47,8           | 33,3                   | 43,6      | 44,5                   | 74                     | 24,05                  | 4,0                    | 57,0                           | 205 |
| VG95234U1-36-*   | CA3100E36-**-B-***   | 59,6                    | M5                           | 4,3                    | 47,8           | 38,5                   | 43,6      | 49,2                   | 74                     | 24,05                  | 4,0                    | 63,5                           | 270 |

<sup>1)</sup> Weight without insulator, grommets and contacts.

## Straight Plug

VG95234 Style V

CA3101E-B, -02, -03 or -06 designates a cable connection plug with adapter for heat shrinkable boots

CA3101E-B and Modifications, see page 9



| VG95234 Part no. | Cannon Part no.      | d <sub>1</sub><br>-0,15 | d <sub>2</sub> <sup>2)</sup><br>min. | d <sub>3</sub><br>±0,2 | d <sub>4</sub><br>max. | d <sub>5</sub><br>max. | l <sub>1</sub><br>max. | l <sub>2</sub><br>+0,4 | l <sub>3</sub><br>±0,2 | l <sub>4</sub><br>±0,5 | l <sub>5</sub> | Weight <sup>1)</sup><br>g max. |
|------------------|----------------------|-------------------------|--------------------------------------|------------------------|------------------------|------------------------|------------------------|------------------------|------------------------|------------------------|----------------|--------------------------------|
| VG95234V-10SL-*  | CA3101E10SL-**-B-*** | 18,2                    | 7,7                                  | 15,5                   | 25,2                   | 13,3                   | 57                     | 18,2                   | 2,8                    | 11,7                   | 20,6           | 35                             |
| –                | CA3101E12S-**-B-***  | 21,4                    | 7,9                                  | 15,5                   | 27,8                   | 13,3                   | 57                     | 18,2                   | 3,2                    | 11,7                   | 23,6           | 45                             |
| VG95234V-14S-*   | CA3101E14S-**-B-***  | 24,6                    | 10,6                                 | 19,1                   | 29,8                   | 17,0                   | 57                     | 18,2                   | 3,2                    | 11,7                   | 25,4           | 50                             |
| VG95234V-16S-*   | CA3101E16S-**-B-***  | 27,4                    | 13,5                                 | 23,9                   | 32,3                   | 21,9                   | 57                     | 18,2                   | 3,2                    | 11,7                   | 28,6           | 60                             |
| VG95234V-16-*    | CA3101E16-**-B-***   | 27,4                    | 13,5                                 | 23,9                   | 32,3                   | 21,9                   | 63                     | 21,5                   | 3,2                    | 11,5                   | 28,6           | 65                             |
| VG95234V-18-*    | CA3101E18-**-B-***   | 30,8                    | 14,6                                 | 23,9                   | 34,8                   | 21,9                   | 65                     | 23,05                  | 4,0                    | 11,5                   | 31,7           | 80                             |
| VG95234V-20-*    | CA3101E20-**-B-***   | 34,2                    | 18,7                                 | 29,6                   | 37,8                   | 26,2                   | 68                     | 23,05                  | 4,0                    | 12,7                   | 34,9           | 95                             |
| VG95234V-22-*    | CA3101E22-**-B-***   | 37,4                    | 20,8                                 | 29,6                   | 41,1                   | 26,2                   | 68                     | 23,05                  | 4,0                    | 12,7                   | 38,1           | 105                            |
| VG95234V-24-*    | CA3101E24-**-B-***   | 40,9                    | 24,6                                 | 37,8                   | 44,6                   | 34,5                   | 70                     | 23,05                  | 4,0                    | 12,7                   | 41,3           | 140                            |
| VG95234V-28-*    | CA3101E28-**-B-***   | 46,7                    | 27,0                                 | 37,8                   | 50,9                   | 34,5                   | 71                     | 24,05                  | 4,0                    | 12,7                   | 47,6           | 160                            |
| VG95234V-32-*    | CA3101E32-**-B-***   | 53,4                    | 33,3                                 | 47,8                   | 57,1                   | 43,6                   | 74                     | 24,05                  | 4,0                    | 15,2                   | 54,0           | 205                            |
| VG95234V-36-*    | CA3101E36-**-B-***   | 59,6                    | 38,5                                 | 47,8                   | 63,6                   | 43,6                   | 74                     | 24,05                  | 4,0                    | 15,2                   | 60,6           | 270                            |

<sup>1)</sup> Weight without insulator, grommets and contacts.

<sup>2)</sup> For max. cable entry.

# Cannon VG/CA-Bayonet

## Wall Mounting Receptacle

CA3100E-B-08 (Flange with threaded holes)  
CA3100E-B-09 (Flange with through holes)

CA3100E-B-08, -09 designates a wall mounting receptacle, with 90° endbell, cable clamp and telescoping bushing.

Modification see page 9



| Cannon Part no.      | d <sub>1</sub><br>-0,15 | d <sub>2</sub> |             | d <sub>3</sub> <sup>2)</sup><br>max. | e<br>±0,4 | l <sub>1</sub><br>max. | l <sub>2</sub><br>+0,4 | l <sub>3</sub><br>±0,2 | l <sub>4</sub><br>max. | l <sub>5</sub><br>max. | l <sub>6</sub><br>max. | l <sub>7</sub><br>max. | Weight <sup>1)</sup><br>g max. |
|----------------------|-------------------------|----------------|-------------|--------------------------------------|-----------|------------------------|------------------------|------------------------|------------------------|------------------------|------------------------|------------------------|--------------------------------|
|                      |                         | Thread Mod. 08 | H13 Mod. 09 |                                      |           |                        |                        |                        |                        |                        |                        |                        |                                |
| CA3100E10SL-**-B-*** | 18,2                    | M4             | 3,2         | 6,5                                  | 18,2      | 50                     | 18,2                   | 2,8                    | 25,4                   | 42                     | 22,7                   | 100                    | 50                             |
| CA3100E12S-**-B-***  | 21,4                    | M4             | 3,2         | 6,5                                  | 20,6      | 50                     | 18,2                   | 3,2                    | 28,0                   | 42                     | 22,7                   | 100                    | 60                             |
| CA3100E14S-**-B-***  | 24,6                    | M4             | 3,2         | 9,0                                  | 23,0      | 52                     | 18,2                   | 3,2                    | 30,0                   | 42                     | 27,5                   | 100                    | 70                             |
| CA3100E16S-**-B-***  | 27,4                    | M4             | 3,2         | 11,0                                 | 24,6      | 53                     | 18,2                   | 3,2                    | 32,5                   | 45                     | 30,0                   | 100                    | 80                             |
| CA3100E16-**-B-***   | 27,4                    | M4             | 3,2         | 11,0                                 | 24,6      | 60                     | 21,5                   | 3,2                    | 32,5                   | 45                     | 30,0                   | 100                    | 90                             |
| CA3100E18-**-B-***   | 30,8                    | M4             | 3,2         | 14,2                                 | 27,0      | 62                     | 23,05                  | 4,0                    | 35,0                   | 53                     | 33,0                   | 100                    | 100                            |
| CA3100E20-**-B-***   | 34,2                    | M4             | 3,2         | 15,8                                 | 29,4      | 66                     | 23,05                  | 4,0                    | 38,0                   | 53                     | 37,5                   | 100                    | 120                            |
| CA3100E22-**-B-***   | 37,4                    | M4             | 3,2         | 15,8                                 | 31,8      | 66                     | 23,05                  | 4,0                    | 41,0                   | 53                     | 37,5                   | 100                    | 130                            |
| CA3100E24-**-B-***   | 40,9                    | M4             | 3,7         | 21,4                                 | 34,9      | 69                     | 23,05                  | 4,0                    | 44,5                   | 58                     | 43,3                   | 100                    | 170                            |
| CA3100E28-**-B-***   | 46,7                    | M5             | 3,7         | 21,4                                 | 39,7      | 70                     | 24,05                  | 4,0                    | 50,8                   | 58                     | 43,3                   | 100                    | 200                            |
| CA3100E32-**-B-***   | 53,4                    | M5             | 4,3         | 26,7                                 | 44,5      | 74                     | 24,05                  | 4,0                    | 57,0                   | 66                     | 51,7                   | 110                    | 265                            |
| CA3100E36-**-B-***   | 59,6                    | M5             | 4,3         | 31,7                                 | 49,2      | 78                     | 24,05                  | 4,0                    | 63,5                   | 69                     | 58,0                   | 110                    | 325                            |

<sup>1)</sup> Weight without insulator, grommets and contacts.

<sup>2)</sup> For max. cable entry.

## Wall Mounting Receptacle

CA3100F-B-08 (Flange with threaded holes)  
CA3100F-B-09 (Flange with through holes)

CA3100F-B, -08, -09 designates a wall mounting receptacle with 90° endbell and for protective hose

Modifications see page 9



Mod -09

| Cannon Part no.      | d <sub>1</sub><br>-0,15 | d <sub>2</sub> |     | d <sub>3</sub><br>Thread | e<br>±0,1 | l <sub>1</sub><br>max. | l <sub>2</sub><br>+0,4 | l <sub>3</sub><br>±0,2 | l <sub>4</sub><br>±0,3 | l <sub>5</sub><br>min. | l <sub>6</sub><br>max. | Weight <sup>1)</sup><br>g max. |
|----------------------|-------------------------|----------------|-----|--------------------------|-----------|------------------------|------------------------|------------------------|------------------------|------------------------|------------------------|--------------------------------|
|                      |                         | Thread         | H13 |                          |           |                        |                        |                        |                        |                        |                        |                                |
| CA3100F10SL-**-B-*** | 18,2                    | M4             | 3,2 | 5/8-24UNEF-2A            | 18,2      | 50                     | 18,2                   | 2,8                    | 25,4                   | 9,4                    | 30                     | 47                             |
| CA3100F12S-**-B-***  | 21,4                    | M4             | 3,2 | 5/8-24UNEF-2A            | 20,6      | 50                     | 18,2                   | 3,2                    | 28,0                   | 9,4                    | 30                     | 57                             |
| CA3100F14S-**-B-***  | 24,6                    | M4             | 3,2 | 3/4-20UNEF-2A            | 23,0      | 52                     | 18,2                   | 3,2                    | 30,0                   | 9,4                    | 30                     | 57                             |
| CA3100F16S-**-B-***  | 27,4                    | M4             | 3,2 | 7/8-20UNEF-2A            | 24,6      | 53                     | 18,2                   | 3,2                    | 32,5                   | 9,4                    | 30                     | 75                             |
| CA3100F16-**-B-***   | 27,4                    | M4             | 3,2 | 7/8-20UNEF-2A            | 24,6      | 60                     | 21,5                   | 3,2                    | 32,5                   | 9,4                    | 30                     | 85                             |
| CA3100F18-**-B-***   | 30,8                    | M4             | 3,2 | 1-20UNEF-2A              | 27,0      | 62                     | 23,05                  | 4,0                    | 35,0                   | 9,4                    | 35                     | 95                             |
| CA3100F20-**-B-***   | 34,2                    | M4             | 3,2 | 1 3/16-18UNEF-2A         | 29,4      | 66                     | 23,05                  | 4,0                    | 38,0                   | 9,4                    | 35                     | 115                            |
| CA3100F22-**-B-***   | 37,4                    | M4             | 3,2 | 1 3/16-18UNEF-2A         | 31,8      | 66                     | 23,05                  | 4,0                    | 41,0                   | 9,4                    | 35                     | 125                            |
| CA3100F24-**-B-***   | 40,9                    | M4             | 3,7 | 1 7/16-18UNEF-2A         | 34,9      | 69                     | 23,05                  | 4,0                    | 44,5                   | 9,4                    | 40                     | 160                            |
| CA3100F28-**-B-***   | 46,7                    | M5             | 3,7 | 1 7/16-18UNEF-2A         | 39,7      | 70                     | 24,05                  | 4,0                    | 50,8                   | 9,4                    | 40                     | 190                            |
| CA3100F32-**-B-***   | 53,4                    | M5             | 4,3 | 1 3/4-18UNS-2A           | 44,5      | 74                     | 24,05                  | 4,0                    | 57,0                   | 11,0                   | 45                     | 250                            |
| CA3100F36-**-B-***   | 59,6                    | M5             | 4,3 | 2-18UNS-2A               | 49,2      | 78                     | 24,05                  | 4,0                    | 63,5                   | 12,6                   | 50                     | 310                            |

<sup>1)</sup> Weight without insulator, grommets and contacts.



Dimensions shown in mm  
Specifications and dimensions subject to change

www.ittcannon.com

## Wall Mounting Receptacles

CA3100R-B designates a wall mounting receptacle with short endbell without cable clamp.

CA3100R-B and Modifications, see page 9



| Cannon Part no.      | d <sub>1</sub><br>-0,15 | d <sub>2</sub><br>Thread | H13 | d <sub>3</sub> <sup>2)</sup><br>min. | d <sub>4</sub><br>max. | e<br>±0,1 | l <sub>1</sub><br>max. | l <sub>2</sub><br>+0,4 | l <sub>3</sub><br>±0,2 | l <sub>4</sub><br>±0,3 | Weight <sup>1)</sup><br>g max. |
|----------------------|-------------------------|--------------------------|-----|--------------------------------------|------------------------|-----------|------------------------|------------------------|------------------------|------------------------|--------------------------------|
| CA3100R10SL-**-B-*** | 18,2                    | M4                       | 3,2 | 9,6                                  | 22,0                   | 18,2      | 50                     | 18,2                   | 2,8                    | 25,4                   | 40                             |
| CA3100R12S-**-B-***  | 21,4                    | M4                       | 3,2 | 10,3                                 | 23,0                   | 20,6      | 52                     | 18,2                   | 3,2                    | 28,0                   | 50                             |
| CA3100R14S-**-B-***  | 24,6                    | M4                       | 3,2 | 12,4                                 | 27,0                   | 23,0      | 52                     | 18,2                   | 3,2                    | 30,0                   | 60                             |
| CA3100R16S-**-B-***  | 27,4                    | M4                       | 3,2 | 15,4                                 | 28,0                   | 24,6      | 58                     | 18,2                   | 3,2                    | 32,5                   | 70                             |
| CA3100R16-**-B-***   | 27,4                    | M4                       | 3,2 | 15,4                                 | 28,0                   | 24,6      | 58                     | 21,5                   | 3,2                    | 32,5                   | 75                             |
| CA3100R18-**-B-***   | 30,8                    | M4                       | 3,2 | 18,4                                 | 31,0                   | 27,0      | 65                     | 23,05                  | 4,0                    | 35,0                   | 90                             |
| CA3100R20-**-B-***   | 34,2                    | M4                       | 3,2 | 22,0                                 | 35,0                   | 29,4      | 65                     | 23,05                  | 4,0                    | 38,0                   | 110                            |
| CA3100R22-**-B-***   | 37,4                    | M4                       | 3,2 | 24,7                                 | 38,0                   | 31,8      | 65                     | 23,05                  | 4,0                    | 41,0                   | 125                            |
| CA3100R24-**-B-***   | 40,9                    | M4                       | 3,7 | 27,6                                 | 42,0                   | 34,9      | 67                     | 23,05                  | 4,0                    | 44,5                   | 160                            |
| CA3100R28-**-B-***   | 46,7                    | M5                       | 3,7 | 31,6                                 | 49,0                   | 39,7      | 67                     | 24,05                  | 4,0                    | 50,8                   | 190                            |
| CA3100R32-**-B-***   | 53,4                    | M5                       | 4,3 | 38,5                                 | 55,0                   | 44,5      | 67                     | 24,05                  | 4,0                    | 57,0                   | 230                            |
| CA3100R36-**-B-***   | 59,6                    | M5                       | 4,3 | 44,5                                 | 62,0                   | 49,2      | 67                     | 24,05                  | 4,0                    | 63,5                   | 300                            |

<sup>1)</sup> Weight without insulator, grommets and contacts.

<sup>2)</sup> For max. cable entry.

## Straight Plug

CA3101F-B - designates a cable connection plug for flex tube

CA3101F-B and Modifications, see page 9



| Cannon Part no.      | d <sub>1</sub><br>-0,15 | d <sub>2</sub> <sup>2)</sup><br>min. | d <sub>3</sub><br>Thread | d <sub>4</sub><br>max. | l <sub>1</sub><br>max. | l <sub>2</sub><br>+0,4 | l <sub>3</sub><br>±0,2 | l <sub>4</sub><br>min. | l <sub>5</sub><br>±0,2 | Weight <sup>1)</sup><br>g max. |
|----------------------|-------------------------|--------------------------------------|--------------------------|------------------------|------------------------|------------------------|------------------------|------------------------|------------------------|--------------------------------|
| CA3101F10SL-**-B-*** | 18,2                    | 8,2                                  | 5/8-24NEF-2A             | 25,2                   | 52                     | 18,2                   | 2,8                    | 9,5                    | 20,6                   | 35                             |
| CA3101F12S-**-B-***  | 21,4                    | 8,2                                  | 5/8-24NEF-2A             | 27,8                   | 52                     | 18,2                   | 3,2                    | 9,5                    | 23,6                   | 45                             |
| CA3101F14S-**-B-***  | 24,6                    | 11,1                                 | 3/4-20UNEF-2A            | 29,8                   | 52                     | 18,2                   | 3,2                    | 9,5                    | 25,4                   | 50                             |
| CA3101F16S-**-B-***  | 27,4                    | 14,3                                 | 7/8-20UNEF-2A            | 32,3                   | 59                     | 18,2                   | 3,2                    | 9,5                    | 28,6                   | 60                             |
| CA3101F16-**-B-***   | 27,4                    | 14,3                                 | 7/8-20UNEF-2A            | 32,3                   | 59                     | 21,5                   | 3,2                    | 9,5                    | 28,6                   | 65                             |
| CA3101F18-**-B-***   | 30,8                    | 16,7                                 | 1-20UNEF-2A              | 34,8                   | 63                     | 23,05                  | 4,0                    | 9,5                    | 31,7                   | 80                             |
| CA3101F20-**-B-***   | 34,2                    | 19,8                                 | 1 3/16-18UNEF-2A         | 37,8                   | 63                     | 23,05                  | 4,0                    | 9,5                    | 34,9                   | 95                             |
| CA3101F22-**-B-***   | 37,4                    | 19,8                                 | 1 3/16-18UNEF-2A         | 41,1                   | 66                     | 23,05                  | 4,0                    | 9,5                    | 38,1                   | 105                            |
| CA3101F24-**-B-***   | 40,9                    | 25,4                                 | 1 7/16-18UNEF-2A         | 44,6                   | 69                     | 23,05                  | 4,0                    | 9,5                    | 41,3                   | 140                            |
| CA3101F28-**-B-***   | 46,7                    | 27,0                                 | 1 7/16-18UNEF-2A         | 50,9                   | 70                     | 24,05                  | 4,0                    | 9,5                    | 47,6                   | 160                            |
| CA3101F32-**-B-***   | 53,4                    | 32,5                                 | 1 3/4-16UNS-2A           | 57,1                   | 71                     | 24,05                  | 4,0                    | 11,0                   | 54,0                   | 205                            |
| CA3101F36-**-B-***   | 59,6                    | 35,7                                 | 2-18UNS-2A               | 63,6                   | 73                     | 24,05                  | 4,0                    | 11,8                   | 60,6                   | 270                            |

<sup>1)</sup> Weight without insulator, grommets and contacts.

<sup>2)</sup> For max. cable entry.

## Wall Mounting Receptacle

CA3100F-B designates a wall mounting receptacle with straight endbell and protective hose.

CA3100F-B and Modifications, see page 9



Mod -05

| Cannon Part no.      | d <sub>1</sub><br>-0,15 | d <sub>2</sub> |      | d <sub>3</sub> <sup>2)</sup> | d <sub>4</sub><br>Thread | e<br>±0,1 | l <sub>1</sub><br>max. | l <sub>2</sub><br>+0,4 | l <sub>3</sub><br>±0,2 | l <sub>4</sub><br>±0,3 | l <sub>5</sub><br>min. | Weight <sup>1)</sup><br>g max. |
|----------------------|-------------------------|----------------|------|------------------------------|--------------------------|-----------|------------------------|------------------------|------------------------|------------------------|------------------------|--------------------------------|
|                      |                         | Thread         | +0,2 |                              |                          |           |                        |                        |                        |                        |                        |                                |
| CA3100F10SL-**-B-*** | 18,2                    | M4             | 3,2  | 8,2                          | 5/8-24NEF-2A             | 18,2      | 52                     | 18,2                   | 2,8                    | 25,4                   | 9,5                    | 40                             |
| CA3100F12S-**-B-***  | 21,4                    | M4             | 3,2  | 8,2                          | 5/8-24NEF-2A             | 20,6      | 52                     | 18,2                   | 3,2                    | 28,0                   | 9,5                    | 50                             |
| CA3100F14S-**-B-***  | 24,5                    | M4             | 3,2  | 11,1                         | 3/4-20UNEF-2A            | 23,0      | 52                     | 18,2                   | 3,2                    | 30,0                   | 9,5                    | 60                             |
| CA3100F16S-**-B-***  | 27,4                    | M4             | 3,2  | 14,3                         | 7/8-20UNEF-2A            | 24,6      | 59                     | 18,2                   | 3,2                    | 32,5                   | 9,5                    | 70                             |
| CA3100F16-**-B-***   | 27,4                    | M4             | 3,2  | 14,3                         | 7/8-20UNEF-2A            | 24,6      | 59                     | 21,5                   | 3,2                    | 32,5                   | 9,5                    | 75                             |
| CA3100F18-**-B-***   | 30,8                    | M4             | 3,2  | 16,7                         | 1-20UNEF-2A              | 27,0      | 63                     | 23,05                  | 4,0                    | 35,0                   | 9,5                    | 90                             |
| CA3100F20-**-B-***   | 34,2                    | M4             | 3,2  | 19,8                         | 1 3/16-18UNEF-2A         | 29,4      | 63                     | 23,05                  | 4,0                    | 38,0                   | 9,5                    | 110                            |
| CA3100F22-**-B-***   | 37,4                    | M4             | 3,2  | 19,8                         | 1 3/16-18UNEF-2A         | 31,8      | 66                     | 23,05                  | 4,0                    | 42,0                   | 9,5                    | 125                            |
| CA3100F24-**-B-***   | 40,9                    | M4             | 3,7  | 25,4                         | 1 7/16-18UNEF-2A         | 34,9      | 69                     | 23,05                  | 4,0                    | 44,5                   | 9,5                    | 160                            |
| CA3100F28-**-B-***   | 46,7                    | M5             | 3,7  | 27,0                         | 1 7/16-18UNEF-2A         | 39,7      | 70                     | 24,05                  | 4,0                    | 50,8                   | 9,5                    | 190                            |
| CA3100F32-**-B-***   | 53,4                    | M5             | 4,3  | 32,5                         | 1 3/4-18UNS-2A           | 44,5      | 71                     | 24,05                  | 4,0                    | 57,0                   | 11,0                   | 230                            |
| CA3100F36-**-B-***   | 59,6                    | M5             | 4,3  | 35,7                         | 2-18UNS-2A               | 49,2      | 73                     | 24,05                  | 4,0                    | 63,5                   | 11,8                   | 300                            |

<sup>1)</sup> Weight without insulator, grommets and contacts.

<sup>2)</sup> For max. cable entry.



## Straight Plug

CA3101R-B designates a cable connection plug with short endbell, without cable clamp

CA3101R-B and Modification, see page 9



| Cannon Part no.      | d <sub>1</sub><br>-0,15 | d <sub>2</sub><br>min. | d <sub>3</sub><br>max. | d <sub>4</sub><br>max. | l <sub>1</sub><br>max. | l <sub>2</sub><br>+0,4 | l <sub>3</sub><br>±0,2 | l <sub>5</sub><br>±0,2 | Weight <sup>1)</sup><br>g max. |
|----------------------|-------------------------|------------------------|------------------------|------------------------|------------------------|------------------------|------------------------|------------------------|--------------------------------|
| CA3101R10SL-**-B-*** | 18,2                    | 9,6                    | 22,0                   | 25,2                   | 50                     | 18,2                   | 2,8                    | 20,6                   | 32                             |
| CA3101R12S-**-B-***  | 21,4                    | 10,3                   | 23,0                   | 27,8                   | 52                     | 18,2                   | 3,2                    | 23,6                   | 40                             |
| CA3101R14S-**-B-***  | 24,6                    | 12,4                   | 27,0                   | 29,8                   | 52                     | 18,2                   | 3,2                    | 25,4                   | 47                             |
| CA3101R16S-**-B-***  | 27,4                    | 15,4                   | 28,0                   | 32,3                   | 58                     | 18,2                   | 3,2                    | 28,6                   | 55                             |
| CA3101R16-**-B-***   | 27,4                    | 15,4                   | 28,0                   | 32,3                   | 58                     | 21,5                   | 3,2                    | 28,6                   | 60                             |
| CA3101R18-**-B-***   | 30,8                    | 18,4                   | 31,0                   | 34,8                   | 65                     | 23,05                  | 4,0                    | 31,7                   | 75                             |
| CA3101R20-**-B-***   | 34,2                    | 22,0                   | 35,0                   | 37,8                   | 65                     | 23,05                  | 4,0                    | 34,9                   | 90                             |
| CA3101R22-**-B-***   | 37,4                    | 24,7                   | 38,0                   | 41,1                   | 65                     | 23,05                  | 4,0                    | 38,1                   | 100                            |
| CA3101R24-**-B-***   | 40,9                    | 27,6                   | 42,0                   | 44,6                   | 67                     | 23,05                  | 4,0                    | 41,3                   | 135                            |
| CA3101R28-**-B-***   | 46,7                    | 31,6                   | 49,0                   | 50,9                   | 67                     | 24,05                  | 4,0                    | 47,6                   | 155                            |
| CA3101R32-**-B-***   | 53,4                    | 38,5                   | 55,0                   | 57,1                   | 67                     | 24,05                  | 4,0                    | 54,0                   | 200                            |
| CA3101R36-**-B-***   | 59,6                    | 44,5                   | 62,0                   | 63,6                   | 67                     | 24,05                  | 4,0                    | 60,6                   | 260                            |

<sup>1)</sup> Weight without insulator, grommets and contacts.

## Straight Plug

CA3106R-B designates a straight plug with short endbell, without cable clamp

CA3106R-B and Modification, see page 9

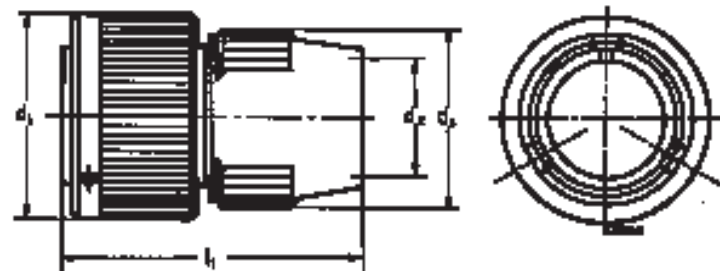

| Cannon Part no.      | d <sub>1</sub><br>max. | d <sub>2</sub> <sup>1)</sup> | d <sub>3</sub><br>max. | l <sub>1</sub><br>max. | Weight<br>g max. |
|----------------------|------------------------|------------------------------|------------------------|------------------------|------------------|
| CA3106R10SL-**-B-*** | 22,8                   | 9,6                          | 22,0                   | 50                     | 27               |
| CA3106R12S-**-B-***  | 26,0                   | 10,3                         | 23,0                   | 50                     | 35               |
| CA3106R14S-**-B-***  | 29,2                   | 12,4                         | 27,0                   | 50                     | 40               |
| CA3106R16S-**-B-***  | 32,0                   | 15,4                         | 28,0                   | 50                     | 50               |
| CA3106R16-**-B-***   | 32,0                   | 15,4                         | 28,0                   | 60                     | 57               |
| CA3106R18-**-B-***   | 36,5                   | 18,4                         | 31,0                   | 62                     | 65               |
| CA3106R20-**-B-***   | 39,9                   | 22,0                         | 35,0                   | 62                     | 80               |
| CA3106R22-**-B-***   | 43,1                   | 24,7                         | 38,0                   | 62                     | 87               |
| CA3106R24-**-B-***   | 46,6                   | 27,6                         | 42,0                   | 62                     | 120              |
| CA3100R28-**-B-***   | 53,4                   | 31,6                         | 49,0                   | 62                     | 150              |
| CA3106R32-**-B-***   | 60,1                   | 38,5                         | 55,0                   | 62                     | 190              |
| CA3106R36-**-B-***   | 66,3                   | 44,5                         | 62,0                   | 62                     | 250              |

<sup>1)</sup> For max. cable entry.

# Cannon VG/CA-Bayonet

## Jam Nut Receptacle

CA07A-B



| Cannon Part no.    | d <sub>1</sub> | d <sub>2</sub> | d <sub>3</sub> Thread | (l <sub>1</sub> ) | l <sub>2</sub> | l <sub>3</sub> | l <sub>4</sub> | d <sub>4</sub> | d <sub>5</sub> | d <sub>6</sub> | d <sub>7</sub> | sw   | d <sub>8</sub> | l <sub>5</sub> | l <sub>6</sub> | l <sub>7</sub> |
|--------------------|----------------|----------------|-----------------------|-------------------|----------------|----------------|----------------|----------------|----------------|----------------|----------------|------|----------------|----------------|----------------|----------------|
| CA07A10SL-**-B-*** | 35,0           | 8,2            | 7/8-20UNEF-2A         | 13,5              | 12,5           | 4,0            | 29,2           | 22,7           | 20,9           | 13,5           | 31,5           | 31,8 | 20,6           | 3,2            | 5,0            | 2,5            |
| CA07A12S-**-B-***  | 38,1           | 8,2            | 1-20UNEF-2A           | 13,5              | 12,5           | 4,0            | 29,2           | 25,7           | 24,1           | 14,8           | 34,7           | 34,9 | 23,8           | 3,2            | 5,0            | 2,5            |
| CA07A14S-**-B-***  | 41,3           | 11,1           | 1 1/8-18UNEF-2A       | 13,5              | 12,5           | 4,0            | 29,2           | 28,8           | 27,2           | 17,9           | 37,9           | 38,1 | 26,9           | 3,2            | 6,0            | 2,5            |
| CA07A16S-**-B-***  | 44,4           | 14,3           | 1 1/4-18UNEF-2A       | 13,5              | 12,5           | 4,0            | 29,2           | 32,0           | 30,4           | 21,1           | 41,0           | 41,2 | 30,1           | 3,2            | 6,0            | 2,5            |
| CA07A16-**-B-***   | 44,4           | 14,3           | 1 1/4-18UNEF-2A       | 13,5              | 21,0           | 4,0            | 37,7           | 32,0           | 30,4           | 21,1           | 41,0           | 41,2 | 30,1           | 3,2            | 6,0            | 2,5            |
| CA07A18-**-B-***   | 48,2           | 16,7           | 1 3/8-18UNEF-2A       | 15,0              | 21,0           | 5,0            | 40,0           | 35,1           | 33,6           | 24,2           | 44,8           | 45,0 | 33,3           | 4,0            | 7,0            | 3,0            |
| CA07A20-**-B-***   | 52,4           | 19,8           | 1 1/2-18UNEF-2A       | 15,0              | 21,0           | 5,0            | 40,0           | 38,2           | 36,8           | 28,2           | 49,0           | 49,2 | 36,5           | 4,0            | 7,0            | 3,0            |
| CA07A22-**-B-***   | 55,5           | 19,8           | 1 5/8-18UNEF-2A       | 15,0              | 21,0           | 5,0            | 40,0           | 42,0           | 39,9           | 31,4           | 52,2           | 52,4 | 39,6           | 4,0            | 7,0            | 3,0            |
| CA07A24-**-B-***   | 59,0           | 25,4           | 1 3/4-18UNEF-2A       | 15,0              | 21,0           | 5,0            | 40,0           | 44,7           | 43,1           | 34,5           | 55,0           | 55,2 | 41,2           | 4,0            | 7,0            | 3,0            |
| CA07A28-**-B-***   | 66,0           | 27,0           | 2-18UNEF-2A           | 15,0              | 21,0           | 5,0            | 40,0           | 51,1           | 49,2           | 40,1           | 62,0           | 62,2 | 47,5           | 4,0            | 7,0            | 3,0            |
| CA07A32-**-B-***   | 72,0           | 32,5           | 2 1/4-16UN-2A         | 15,0              | 21,0           | 5,0            | 40,0           | 57,4           | 55,7           | 46,5           | 68,0           | 68,2 | 54,1           | 4,0            | 7,0            | 3,0            |
| CA07A36-**-B-***   | 80,0           | 35,7           | 1/2-16UN-2A           | 15,0              | 21,0           | 5,0            | 40,0           | 63,8           | 62,0           | 51,2           | 75,0           | 75,2 | 60,5           | 4,0            | 8,0            | 3,0            |

## Straight Plug with PG Adapter

CA06PG-B

CA06GME-B



| Cannon Part no.     | d <sub>1</sub> | d <sub>3</sub> | d <sub>4</sub> | l <sub>1</sub> | l <sub>2</sub> | l <sub>3</sub> | d <sub>2</sub> PG-Thread |
|---------------------|----------------|----------------|----------------|----------------|----------------|----------------|--------------------------|
| CA06PG10SL-**-B-*** | 22,8           | 18,0           | 9,7            | 52             | 9,5            | 7,0            | PG 9                     |
| CA06PG12S-**-B-***  | 26,0           | 18,8           | 10,4           | 52             | 9,5            | 7,0            | PG 9                     |
| CA06PG14S-**-B-***  | 29,2           | 22,0           | 12,5           | 52             | 10,0           | 7,0            | PG11                     |
| CA06PG16S-**-B-***  | 32,0           | 23,6           | 15,0           | 54             | 10,0           | 7,0            | PG13,5                   |
| CA06PG16-**-B-***   | 32,0           | 24,0           | 15,0           | 64             | 10,0           | 7,0            | PG13,5                   |
| CA06PG18-**-B-***   | 36,5           | 24,4           | 17,0           | 69             | 11,5           | 7,5            | PG13,5                   |
| CA06PG20-**-B-***   | 39,9           | 26,8           | 17,0           | 70             | 11,5           | 7,5            | PG16                     |
| CA06PG22-**-B-***   | 42,1           | 26,4           | 17,0           | 73             | 11,5           | 7,5            | PG16                     |
| CA06PG24-**-B-***   | 46,6           | 26,8           | 18,5           | 74             | 12,5           | 7,5            | PG16                     |
| CA06PG28-**-B-***   | 53,4           | 32,0           | 18,5           | 74             | 12,5           | 7,5            | PG21                     |
| CA06PG32-**-B-***   | 60,1           | 40,8           | 24,0           | 76             | 13,5           | 8,5            | PG29                     |
| CA06PG36-**-B-***   | 66,3           | 40,8           | 32,0           | 87             | 15,0           | 9,0            | PG29                     |

| Cannon Part no.     | d <sub>1</sub> | d <sub>3</sub> | d <sub>4</sub> | l <sub>1</sub> | l <sub>2</sub> | l <sub>3</sub> | d <sub>2</sub> Metric |
|---------------------|----------------|----------------|----------------|----------------|----------------|----------------|-----------------------|
| CA06ME10SL-**-B-*** | 22,8           | 18,0           | 9,7            | 52             | 9,5            | 7,0            | M16 X 1,5             |
| CA06ME12S-**-B-***  | 26,0           | 18,8           | 10,4           | 52             | 9,5            | 7,0            | M16 X 1,5             |
| CA06ME14S-**-B-***  | 29,2           | 22,0           | 12,5           | 52             | 10,0           | 7,0            | M20 X 1,5             |
| CA06ME16S-**-B-***  | 32,0           | 23,6           | 15,0           | 54             | 10,0           | 7,0            | M20 X 1,5             |
| CA06ME16-**-B-***   | 32,0           | 24,0           | 15,0           | 64             | 10,0           | 7,0            | M20 X 1,5             |
| CA06ME18-**-B-***   | 36,5           | 24,4           | 17,0           | 69             | 11,5           | 7,5            | M25 X 1,5             |
| CA06ME20-**-B-***   | 39,9           | 26,8           | 17,0           | 70             | 11,5           | 7,5            | M25 X 1,5             |
| CA06ME22-**-B-***   | 42,1           | 26,4           | 17,0           | 73             | 11,5           | 7,5            | M32 X 1,5             |
| CA06ME24-**-B-***   | 46,6           | 26,8           | 18,5           | 74             | 12,5           | 7,5            | M32 X 1,5             |
| CA06ME28-**-B-***   | 53,4           | 32,0           | 18,5           | 74             | 12,5           | 7,5            | upon request          |
| CA06ME32-**-B-***   | 60,1           | 40,8           | 24,0           | 76             | 13,5           | 8,5            | upon request          |
| CA06ME36-**-B-***   | 66,3           | 40,8           | 32,0           | 87             | 15,0           | 9,0            | upon request          |



Dimensions shown in mm  
Specifications and dimensions subject to change

[www.ittcannon.com](http://www.ittcannon.com)

## Coupling Dimensions

for connector style A, B1, B2, C1, C2, F, J1, J2, N1 and N2 resp. CA3100, CA3101, CA3102 and TBF

- A = Contact size 10
- B = Contact size 15S, 15, 16S, 16
- C = Contact size 25, 12
- D = Contact size 60, 100, 160, 500, 8.4, 0
- E = Contact size 10
- F = Contact size 15S, 16S
- G = all others



| Shell size | d <sub>1</sub><br>-0,15 | d <sub>2</sub><br>+0,3 | d <sub>3</sub>                        | d <sub>4</sub><br>+0,4 | d <sub>5</sub><br>+0,8 | l <sub>1</sub><br>min. | l <sub>2</sub><br>±1<br>A-1 | B±1 | C±1 | D   | l <sub>3</sub><br>±0,5 | l <sub>4</sub><br>±1<br>E | F | G   | l <sub>5</sub><br>+0,2 | l <sub>6</sub><br>+0,4 | l <sub>7</sub><br>+0,1<br>-0,05 |
|------------|-------------------------|------------------------|---------------------------------------|------------------------|------------------------|------------------------|-----------------------------|-----|-----|-----|------------------------|---------------------------|---|-----|------------------------|------------------------|---------------------------------|
| 10SL       | 18,2                    | 11,4                   | 9,7 <sup>+0,25</sup> <sub>-0,3</sub>  | 2,75                   | 2,75                   | 14,2                   | -                           | 2,2 | -   | -   | 12,8                   | -                         | 2 | -   | 1,8                    | 4,4                    | 6,3                             |
| 12S        | 21,4                    | 14,2                   | 10,8 <sup>+0,25</sup> <sub>-0,3</sub> | 2,75                   | 2,75                   | 14,2                   | -                           | 2,2 | -   | -   | 12,8                   | -                         | 2 | -   | 1,8                    | 5,9                    | 6,3                             |
| 14S        | 24,6                    | 17,3                   | 13,0 <sup>+0,25</sup> <sub>-0,3</sub> | 2,75                   | 2,75                   | 14,2                   | -                           | 2,2 | -   | -   | 12,8                   | -                         | 2 | -   | 1,8                    | 6,9                    | 6,3                             |
| 16S        | 27,4                    | 20,6                   | 16,1 <sup>+0,25</sup> <sub>-0,3</sub> | 2,75                   | 2,75                   | 14,2                   | -                           | 2,2 | -   | -   | 12,8                   | -                         | 2 | -   | 1,8                    | 8,4                    | 6,3                             |
| 16         | 27,4                    | 20,6                   | 16,1 <sup>+0,25</sup> <sub>-0,3</sub> | 4,65                   | 4,65                   | 19                     | 9,8                         | 6,6 | 3   | 2,3 | 17,6                   | 1,4                       | - | 2,6 | 1,8                    | 8,4                    | 9,6                             |
| 18         | 30,8                    | 23,8                   | 18,8 <sup>±0,4</sup>                  | 4,65                   | 4,65                   | 19                     | 9,8                         | 6,6 | 3   | 2,3 | 17,6                   | 1,4                       | - | 2,6 | 2,0                    | 9,7                    | 9,6                             |
| 20         | 34,2                    | 26,9                   | 22,6 <sup>±0,4</sup>                  | 4,65                   | 4,65                   | 19                     | 9,8                         | 6,6 | 3   | 2,3 | 17,6                   | 1,4                       | - | 2,6 | 2,0                    | 11,7                   | 9,6                             |
| 22         | 37,4                    | 30,0                   | 25,1 <sup>±0,4</sup>                  | 4,65                   | 4,65                   | 19                     | 9,8                         | 6,6 | 3   | 2,3 | 17,6                   | 1,4                       | - | 2,6 | 2,0                    | 12,9                   | 9,6                             |
| 24         | 40,9                    | 33,2                   | 28,2 <sup>±0,4</sup>                  | 4,65                   | 4,65                   | 19                     | 9,8                         | 6,6 | 3   | 2,3 | 17,6                   | 1,4                       | - | 2,6 | 2,0                    | 14,5                   | 9,6                             |
| 28         | 46,7                    | 38,8                   | 33,6 <sup>±0,4</sup>                  | 4,65                   | 4,65                   | 19                     | 9,8                         | 6,6 | 3   | 2,3 | 17,6                   | 1,4                       | - | 2,6 | 2,0                    | 17,3                   | 9,6                             |
| 32         | 53,4                    | 45,2                   | 40,0 <sup>±0,4</sup>                  | 4,65                   | 4,65                   | 19                     | 9,8                         | 6,6 | 3   | 2,3 | 17,6                   | 1,4                       | - | 2,6 | 2,0                    | 20,4                   | 9,6                             |
| 36         | 59,6                    | 50,6                   | 45,5 <sup>±0,4</sup>                  | 4,65                   | 4,65                   | 19                     | 9,8                         | 6,6 | 3   | 2,3 | 17,6                   | 1,4                       | - | 2,6 | 2,0                    | 23,0                   | 9,6                             |

## Coupling Dimensions

for connector style D, E, E1, G and H resp. CA3106 und 3108

- A = Contact size 10
- B = Contact size 15S, 15, 16S, 16
- C = Contact size 25, 12
- D = Contact size 60, 100, 160, 500, 8, 4, 0
- E = Contact size 10
- F = Contact size 15S, 16S
- G = all others



| Shell size | d <sub>1</sub><br>-0,15 | d <sub>2</sub><br>-0,3 | d <sub>3</sub>                        | d <sub>4</sub><br>-0,1 | d <sub>6</sub>       | l <sub>1</sub><br>±0,2 | l <sub>2</sub><br>±1<br>A | B   | C | D   | l <sub>3</sub> <sup>1)</sup><br>±0,5 | l <sub>4</sub><br>±1<br>E | F | G   | l <sub>5</sub><br>+0,05<br>-0,1 | l <sub>8</sub><br>±1 | l <sub>9</sub><br>±0,5 | l <sub>10</sub><br>+0,1<br>-0,05 |
|------------|-------------------------|------------------------|---------------------------------------|------------------------|----------------------|------------------------|---------------------------|-----|---|-----|--------------------------------------|---------------------------|---|-----|---------------------------------|----------------------|------------------------|----------------------------------|
| 10SL       | 18,2                    | 11,3                   | 9,7 <sup>+0,25</sup> <sub>-0,3</sub>  | 2,6                    | 10,0 <sup>+0,3</sup> | 13,5                   | -                         | 2,2 | - | -   | 12,8                                 | -                         | 2 | -   | 1,6                             | 11,8                 | 14                     | 2,1                              |
| 12S        | 21,4                    | 14,0                   | 10,8 <sup>+0,25</sup> <sub>-0,3</sub> | 2,6                    | 11,4 <sup>+0,6</sup> | 13,5                   | -                         | 2,2 | - | -   | 12,8                                 | -                         | 2 | -   | 1,6                             | 11,8                 | 14                     | 2,1                              |
| 14S        | 24,8                    | 17,1                   | 13,0 <sup>+0,25</sup> <sub>-0,3</sub> | 2,6                    | 13,3 <sup>+0,6</sup> | 13,5                   | -                         | 2,2 | - | -   | 12,8                                 | -                         | 2 | -   | 1,6                             | 11,8                 | 14                     | 2,1                              |
| 16S        | 27,6                    | 20,4                   | 16,1 <sup>+0,25</sup> <sub>-0,3</sub> | 2,6                    | 16,4 <sup>+0,6</sup> | 13,5                   | -                         | 2,2 | - | -   | 12,8                                 | -                         | 2 | -   | 1,6                             | 11,8                 | 14                     | 2,1                              |
| 16         | 27,6                    | 20,4                   | 16,1 <sup>+0,25</sup> <sub>-0,3</sub> | 4,5                    | 16,4 <sup>+0,6</sup> | 18,2                   | 9,8                       | 6,6 | 3 | 2,3 | 17,6                                 | 1,4                       | - | 2,6 | 1,6                             | 16,0                 | 18,8                   | 2,1                              |
| 18         | 31,1                    | 23,6                   | 18,8 <sup>±0,4</sup>                  | 4,5                    | 19,6 <sup>+0,6</sup> | 18,2                   | 9,8                       | 6,6 | 3 | 2,3 | 17,6                                 | 1,4                       | - | 2,6 | 1,8                             | 16,0                 | 18,8                   | 2,1                              |
| 20         | 34,5                    | 26,7                   | 22,6 <sup>±0,4</sup>                  | 4,5                    | 23,6 <sup>+0,6</sup> | 18,2                   | 9,8                       | 6,6 | 3 | 2,3 | 17,6                                 | 1,4                       | - | 2,6 | 1,8                             | 16,0                 | 18,8                   | 2,1                              |
| 22         | 37,7                    | 29,8                   | 25,1 <sup>±0,4</sup>                  | 4,5                    | 26,0 <sup>+0,6</sup> | 18,2                   | 9,8                       | 6,6 | 3 | 2,3 | 17,6                                 | 1,4                       | - | 2,6 | 1,8                             | 16,0                 | 18,8                   | 2,1                              |
| 24         | 41,2                    | 33,0                   | 28,2 <sup>±0,4</sup>                  | 4,5                    | 29,1 <sup>+0,7</sup> | 18,2                   | 9,8                       | 6,6 | 3 | 2,3 | 17,6                                 | 1,4                       | - | 2,6 | 1,8                             | 16,8                 | 19,6                   | 2,8                              |
| 28         | 47,0                    | 38,6                   | 33,6 <sup>±0,4</sup>                  | 4,5                    | 34,7 <sup>+0,7</sup> | 18,2                   | 9,8                       | 6,6 | 3 | 2,3 | 17,6                                 | 1,4                       | - | 2,6 | 1,8                             | 16,8                 | 19,6                   | 2,8                              |
| 32         | 53,7                    | 44,9                   | 40,0 <sup>±0,4</sup>                  | 4,5                    | 41,0 <sup>+0,7</sup> | 18,2                   | 9,8                       | 6,6 | 3 | 2,3 | 17,6                                 | 1,4                       | - | 2,6 | 1,8                             | 16,8                 | 19,6                   | 2,8                              |
| 36         | 59,9                    | 50,3                   | 45,5 <sup>±0,4</sup>                  | 4,5                    | 46,6 <sup>+0,7</sup> | 19                     | 9,8                       | 6,6 | 3 | 2,3 | 17,6                                 | 1,4                       | - | 2,6 | 1,8                             | 16,8                 | 19,6                   | 2,8                              |

<sup>1)</sup> In terminated condition

# Cannon VG/CA-Bayonet

## Mating Dimensions

for shell styles K, L and M, shown without coupling nut

| Size | d <sub>8</sub><br>min. | Size | d <sub>8</sub><br>min. |
|------|------------------------|------|------------------------|
| 14S  | 17,9                   | 22   | 30,7                   |
| 16S  | 21,2                   | 24   | 33,9                   |
| 16   | 21,2                   | 28   | 39,5                   |
| 18   | 24,4                   | 32   | 46,0                   |
| 20   | 27,6                   | 36   | 51,4                   |



## Plastic Protecting Caps



Colour: red  
(similar to RAL 2003)



| Part no.     | Protecting cap for        |                     | ø A<br>max. | ø B<br>-0,2 | ø D<br>+0,2 | F<br>±0,2 | G<br>±0,2 | H<br>max. |
|--------------|---------------------------|---------------------|-------------|-------------|-------------|-----------|-----------|-----------|
|              | Receptacles<br>Shell size | Plugs<br>Shell size |             |             |             |           |           |           |
| 025-8636-005 | 10S/10SL                  | -                   | 22,8        | 17,7        | 19,7        | 10,7      | 14,2      | 15,9      |
| 025-8636-006 | -                         | 10S/10SL            | 22,8        | 10,7        | 12,9        | 15,5      | 17,0      | 18,7      |
| 025-8636-008 | -                         | 12S                 | 26,0        | 13,4        | 15,8        | 15,5      | 17,0      | 18,7      |
| 025-8636-010 | 12S/12                    | -                   | 26,0        | 20,9        | 22,9        | 10,7      | 14,2      | 15,9      |
| 025-8636-016 | 14S/14                    | -                   | 29,2        | 24,1        | 26,1        | 10,7      | 14,2      | 15,9      |
| 025-8636-017 | -                         | 14S                 | 29,2        | 16,5        | 19,1        | 15,5      | 17,0      | 18,7      |
| 025-8636-018 | -                         | 14                  | 29,2        | 16,5        | 19,1        | 20,2      | 21,7      | 23,4      |
| 025-8636-022 | -                         | 16S                 | 32,0        | 19,8        | 22,4        | 15,5      | 17,0      | 18,7      |
| 025-8636-024 | -                         | 16                  | 32,0        | 19,8        | 22,4        | 20,2      | 21,7      | 23,4      |
| 025-8636-025 | 16S                       | -                   | 32,0        | 26,9        | 28,9        | 10,7      | 14,2      | 15,9      |
| 025-8636-026 | 16                        | -                   | 32,0        | 26,9        | 28,9        | 17,5      | 19,0      | 20,7      |
| 025-8636-034 | 18                        | -                   | 36,5        | 30,3        | 32,3        | 17,5      | 19,0      | 20,7      |
| 025-8636-036 | -                         | 18                  | 36,5        | 23,0        | 25,6        | 20,2      | 21,7      | 23,4      |
| 025-8636-042 | 20                        | -                   | 39,9        | 33,7        | 35,7        | 17,5      | 19,0      | 20,7      |
| 025-8636-044 | -                         | 20                  | 39,9        | 26,1        | 28,8        | 20,2      | 21,7      | 23,4      |
| 025-8636-048 | -                         | 22                  | 43,1        | 29,2        | 31,9        | 20,2      | 21,7      | 23,4      |
| 025-8636-049 | 22                        | -                   | 43,1        | 36,9        | 38,9        | 17,5      | 19,0      | 20,7      |
| 025-8636-053 | 24                        | -                   | 46,6        | 40,4        | 42,4        | 19,1      | 20,6      | 22,3      |
| 025-8636-054 | -                         | 24                  | 46,6        | 32,4        | 35,1        | 20,2      | 21,7      | 23,4      |
| 025-8636-058 | 28                        | -                   | 53,4        | 46,2        | 48,2        | 19,1      | 20,6      | 22,3      |
| 025-8636-060 | -                         | 28                  | 53,4        | 38,0        | 40,7        | 20,2      | 21,7      | 23,4      |
| 025-8636-061 | -                         | 32                  | 60,1        | 44,3        | 47,2        | 20,2      | 21,7      | 23,4      |
| 025-8636-062 | 32                        | -                   | 64,9        | 52,9        | 54,9        | 20,7      | 22,2      | 23,9      |
| 025-8636-064 | 36                        | -                   | 71,1        | 59,1        | 60,1        | 20,7      | 22,2      | 23,9      |
| 025-8636-065 | -                         | 36                  | 66,3        | 49,7        | 51,6        | 20,2      | 21,7      | 23,4      |

**Metal Protecting Caps**

for receptacles, shell style  
 3100, 3101 und 3102  
 Material: Aluminum alloy

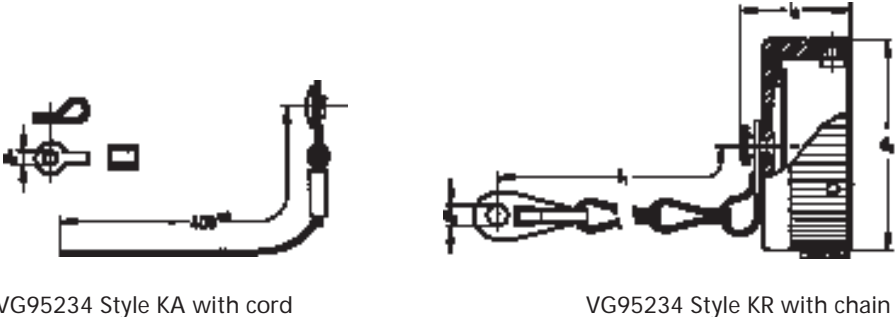

| Shell size | VG95234 Part no. with chain | VG95234 Part no. with cord | Cannon Part no. with chain | Cannon Part no. with cord | d <sub>1</sub> max. | d <sub>2</sub> +0,6 | l <sub>1</sub> min. f. chain | l <sub>2</sub> max. | Weight g max. |
|------------|-----------------------------|----------------------------|----------------------------|---------------------------|---------------------|---------------------|------------------------------|---------------------|---------------|
| 10SL       | VG95234KR10SL               | VG95234KA10SL              | CA121003-1                 | CAB81-10SL-D              | 23,5                | 4,3                 | 90                           | 20                  | 16            |
| 12S        | -                           | -                          | CA121003-2                 | CAB81-12S-D               | 27,0                | 4,3                 | 90                           | 20                  | 17            |
| 14S        | VG95234KR14S                | VG95234KA14S               | CA121003-3                 | CAB81-14S-D               | 30,5                | 4,3                 | 90                           | 20                  | 18            |
| 16S        | VG95234KR16S                | VG95234KA16S               | CA121003-4                 | CAB81-16S-D               | 33,0                | 4,3                 | 90                           | 20                  | 19            |
| 16         | VG95234KR16                 | VG95234KA16                | CA121003-5                 | CAB81-16-D                | 33,0                | 4,3                 | 100                          | 25                  | 23            |
| 18         | VG95234KR18                 | VG95234KA18                | CA121003-6                 | CAB81-18-D                | 37,5                | 4,3                 | 100                          | 25                  | 27            |
| 20         | VG95234KR20                 | VG95234KA20                | CA121003-7                 | CAB81-20-D                | 41,0                | 4,3                 | 115                          | 25                  | 30            |
| 22         | VG95234KR22                 | VG95234KA22                | CA121003-8                 | CAB81-22-D                | 44,0                | 4,3                 | 115                          | 25                  | 33            |
| 24         | VG95234KR24                 | VG95234KA24                | CA121003-9                 | CAB81-24-D                | 47,5                | 4,3                 | 115                          | 25                  | 37            |
| 28         | VG95234KR28                 | VG95234KA28                | CA121003-10                | CAB81-28-D                | 54,5                | 5,5                 | 160                          | 25                  | 42            |
| 32         | VG95234KR32                 | VG95234KA32                | CA121003-11                | CAB81-32-D                | 61,0                | 5,5                 | 160                          | 25                  | 48            |
| 36         | VG95234KR36                 | VG95234KA36                | CA121003-12                | CAB81-36-D                | 67,5                | 5,5                 | 160                          | 25                  | 55            |

**Metal Protecting Caps**

for plugs, shell style  
 3106 and 3108  
 Material: Aluminum alloy

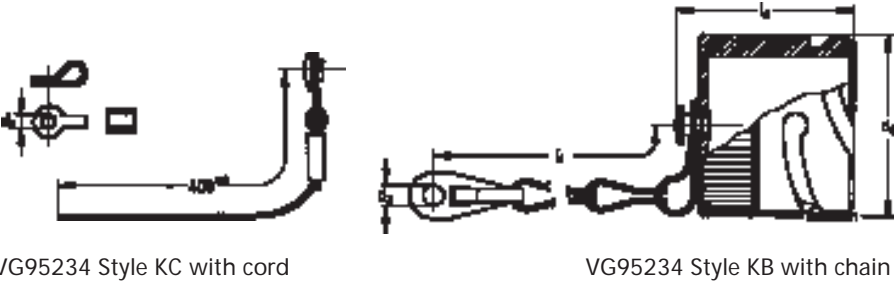

| Shell size | VG95234 Part no. with chain | VG95234 Part no. with cord | Cannon Part no. with chain | Cannon Part no. with cord | d <sub>1</sub> max. | d <sub>2</sub> | l <sub>1</sub> | l <sub>2</sub> max. | Weight g max. |
|------------|-----------------------------|----------------------------|----------------------------|---------------------------|---------------------|----------------|----------------|---------------------|---------------|
| 10SL       | VG95234KB10SL               | VG95234KC10SL              | CA121004-1                 | CAB80-10SL-D              | 21,0                | 4,3            | 90             | 29                  | 19            |
| 12S        | -                           | -                          | CA121004-2                 | CAB80-12S-D               | 24,0                | 4,3            | 100            | 29                  | 23            |
| 14S        | VG95234KB14S                | VG95234KC14S               | CA121004-3                 | CAB80-14S-D               | 27,5                | 4,3            | 100            | 29                  | 26            |
| 16S        | VG95234KB16S                | VG95234KC16S               | CA121004-4                 | CAB80-16S-D               | 30,0                | 4,3            | 100            | 29                  | 28            |
| 16         | VG95234KB16                 | VG95234KC16                | CA121004-5                 | CAB80-16-D                | 30,0                | 4,3            | 115            | 37                  | 33            |
| 18         | VG95234KB18                 | VG95234KC18                | CA121004-6                 | CAB80-18-D                | 33,5                | 4,3            | 115            | 37                  | 36            |
| 20         | VG95234KB20                 | VG95234KC20                | CA121004-7                 | CAB80-20-D                | 37,0                | 4,7            | 130            | 37                  | 43            |
| 22         | VG95234KB22                 | VG95234KC22                | CA121004-8                 | CAB80-22-D                | 40,0                | 4,7            | 130            | 37                  | 47            |
| 24         | VG95234KB24                 | VG95234KC24                | CA121004-9                 | CAB80-24-D                | 43,5                | 4,7            | 130            | 37                  | 53            |
| 28         | VG95234KB28                 | VG95234KC28                | CA121004-10                | CAB80-28-D                | 49,5                | 4,7            | 190            | 37                  | 63            |
| 32         | VG95234KB32                 | VG95234KC32                | CA121004-11                | CAB80-32-D                | 56,0                | 5,5            | 190            | 37                  | 75            |
| 36         | VG95234KB36                 | VG95234KC36                | CA121004-12                | CAB80-36-D                | 62,5                | 5,5            | 190            | 37                  | 88            |

Dimensions shown in mm  
 Specifications and dimensions subject to change

## Dummy Receptacles

Front panel mounting (rear side open)

VG95234 Style BOD (Flange with through-holes)  
CA3105-B

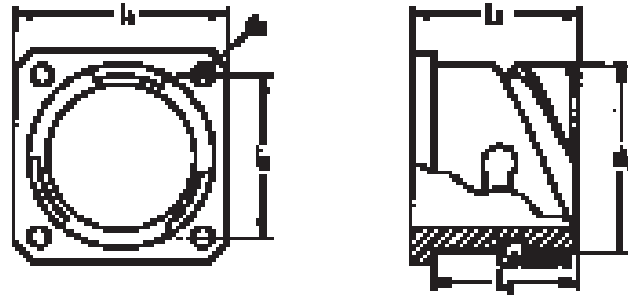

| Shell size | VG 95234 Part no. | Cannon Part no. | d <sub>1</sub><br>-0,15 | d <sub>2</sub><br>±0,2 | l <sub>1</sub><br>±0,3 | l <sub>2</sub><br>±0,1 | l <sub>3</sub><br>max. | l <sub>4</sub><br>+0,3 |
|------------|-------------------|-----------------|-------------------------|------------------------|------------------------|------------------------|------------------------|------------------------|
| 10SL       | VG95234BOD10SL    | CA3105E10SL-B   | 18,2                    | 3,2                    | 25,4                   | 18,2                   | 17,5                   | 14,2                   |
| 12S        | -                 | CA3105E12S-B    | 21,4                    | 3,2                    | 28,0                   | 20,6                   | 18,0                   | 14,2                   |
| 14S        | VG95234BOD14S     | CA3105E14S-B    | 24,6                    | 3,2                    | 30,0                   | 23,0                   | 18,0                   | 14,2                   |
| 16S        | VG95234BOD16S     | CA3105E16S-B    | 27,4                    | 3,2                    | 32,5                   | 24,6                   | 18,0                   | 14,2                   |
| 16         | VG95234BOD16      | CA3105E16-B     | 27,4                    | 3,2                    | 32,5                   | 24,6                   | 23,5                   | 19,0                   |
| 18         | VG95234BOD18      | CA3105E18-B     | 30,8                    | 3,2                    | 35,0                   | 27,0                   | 23,5                   | 19,0                   |
| 20         | VG95234BOD20      | CA3105E20-B     | 34,2                    | 3,2                    | 38,0                   | 29,4                   | 23,5                   | 19,0                   |
| 22         | VG95234BOD22      | CA3105E22-B     | 37,4                    | 3,2                    | 41,0                   | 31,8                   | 23,5                   | 19,0                   |
| 24         | VG95234BOD24      | CA3105E24-B     | 40,9                    | 3,7                    | 44,5                   | 34,9                   | 25,5                   | 20,6                   |
| 28         | VG95234BOD28      | CA3105E28-B     | 46,7                    | 3,7                    | 50,8                   | 39,7                   | 25,5                   | 20,6                   |
| 32         | VG95234BOD32      | CA3105E32-B     | 53,4                    | 4,3                    | 57,0                   | 44,5                   | 27,0                   | 22,2                   |
| 36         | VG95234BOD36      | CA3105E36-B     | 59,6                    | 4,3                    | 63,5                   | 49,2                   | 27,0                   | 22,2                   |

## Dummy Receptacles

Rear panel mounting (rear side closed)



| Shell size | CA3105E-B Cannon Part no. with thread Style A | CA3105E-B-05 Cannon Part no. with through holes Style B | d <sub>1</sub> | l <sub>1</sub><br>±0,25 | l <sub>2</sub><br>±0,3 | l <sub>3</sub> | l <sub>4</sub><br>+0,3 | Style A<br>d <sub>2</sub> | Style B<br>d <sub>2</sub> ±0,2 |
|------------|---|---|----------------|-------------------------|------------------------|----------------|------------------------|---------------------------|--------------------------------|
| 10SL       | 248-8513-000                                  | 248-8501-000  | 18,2           | 25,4                    | 18,2                   | 21,1           | 18,3                   | M4                        | 3,2                            |
| 12S        | 248-8514-000                                  | 248-8502-000  | 21,4           | 28,0                    | 20,6                   | 21,5           | 18,3                   | M4                        | 3,2                            |
| 14S        | 248-8515-000                                  | 248-8503-000  | 24,6           | 30,0                    | 23,0                   | 21,5           | 18,3                   | M4                        | 3,2                            |
| 16S        | 248-8516-000                                  | 248-8504-000  | 27,4           | 32,5                    | 24,6                   | 21,5           | 18,3                   | M4                        | 3,2                            |
| 16         | 248-8517-000                                  | 248-8505-000  | 27,4           | 32,5                    | 24,6                   | 24,8           | 21,6                   | M4                        | 3,2                            |
| 18         | 248-8518-000                                  | 248-8506-000  | 30,8           | 35,0                    | 27,0                   | 27,2           | 23,15                  | M4                        | 3,2                            |
| 20s        | 248-8519-000                                  | 248-8507-000  | 34,2           | 38,0                    | 29,4                   | 27,2           | 23,15                  | M4                        | 3,2                            |
| 22         | 248-8520-000                                  | 248-8508-000  | 37,4           | 41,0                    | 31,8                   | 27,2           | 23,15                  | M4                        | 3,2                            |
| 24         | 248-8521-000                                  | 248-8509-000  | 40,9           | 44,5                    | 34,9                   | 27,2           | 23,15                  | M4                        | 3,7                            |
| 28         | 248-8522-000                                  | 248-8510-000  | 46,7           | 50,8                    | 39,7                   | 28,2           | 24,15                  | M5                        | 3,7                            |
| 32         | 248-8523-000                                  | 248-8511-000  | 53,4           | 57,0                    | 44,5                   | 28,2           | 24,15                  | M5                        | 4,4                            |
| 36         | 248-8524-000                                  | 248-8512-000  | 59,6           | 63,5                    | 49,2                   | 28,2           | 24,15                  | M5                        | 4,4                            |

## Sealing Rings

for use on the barrel of the plug

| Size   | Part no.     | d <sub>9</sub> |
|--------|--------------|----------------|
| 10SL   | 980-8550-000 | 9,0            |
| 12S    | 980-8551-000 | 11,5           |
| 14S    | 980-8552-000 | 14,0           |
| 16/16S | 980-8553-000 | 17,0           |
| 18     | 980-8554-000 | 19,5           |
| 20     | 980-8555-000 | 22,5           |
| 22     | 980-8556-000 | 25,4           |
| 24     | 980-8557-000 | 28,5           |
| 28     | 980-8558-000 | 34,0           |
| 32     | 980-8559-000 | 40,0           |
| 36     | 980-8560-000 | 45,0           |



## Wire Hole Fillers

Where contacts are not used, the contact cavities are to be closed by wire holes fillers.



| Size | VG95234 Part no. | For contact size |        | d <sub>1</sub> ±0,1 | d <sub>2</sub> ±0,2 | l <sub>1</sub> ±0,1 | l <sub>2</sub> ±0,3 | Colour | Part no.     |
|------|------------------|------------------|--------|---------------------|---------------------|---------------------|---------------------|--------|--------------|
|      |                  | metr.            | AWG    |                     |                     |                     |                     |        |              |
| 20   | VG95234B20       | 10               |        | 2,3                 | 3,0                 | 2,4                 | 9,7                 | red    | 225-1000-000 |
| 16S  | VG95234B16S      | 15S              | 16S    | 2,8                 | 3,7                 | 1,5                 | 4,8                 | nature | 225-8510-000 |
| 16   | VG95234B16       | 15S/15           | 16S/16 | 2,8                 | 3,7                 | 3,2                 | 11,9                | blue   | 225-0017-000 |
| 12   | VG95234B12       | 25/25A           | 12     | 3,7                 | 4,6                 | 3,2                 | 11,9                | yellow | 225-0018-000 |
| 8    | VG95234B08       | 60/100           | 8      | 5                   | 5,8                 | 3,2                 | 11,9                | white  | 225-0019-000 |
| 4    | VG95234B04       | 160              | 4      | 7,6                 | 8,5                 | 3,2                 | 11,9                | green  | 225-8502-000 |
| 0    | VG95234B00       | 500              | 0      | 12,8                | 13,5                | 3,2                 | 11,9                | black  | 225-8503-000 |

## Cable Clamps

without telescoping bushing

VG95234 Style KK

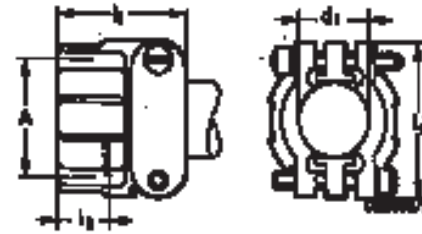

| VG 95234 Part no. | Former Designation MS | Shell size suitable for connectors acc. MS | A-Thread        | l <sub>2</sub> max. | d <sub>1</sub> max. | l <sub>1</sub> max. | l <sub>3</sub> max. | Shell-Weight g |
|-------------------|-----------------------|--|-----------------|---------------------|---------------------|---------------------|---------------------|----------------|
| VG95234KK 4       | MS3057- 4A*           | 10SL, 12S,                                 | 5/7-24NEF-2B    | 10,5                | 7,9                 | 20,8                | 22,5                | 13,2           |
| VG95234KK 6       | MS3057- 6A*           | 14S,                                       | 3/4-20UNEF-2B   | 10,5                | 11,1                | 22,4                | 27,4                | 18,6           |
| VG95234KK 8       | MS3057- 8A*           | 16S, 16                                    | 7/8-20UNEF-2B   | 10,5                | 14,2                | 24,0                | 29,8                | 23,6           |
| VG95234KK12       | MS3057-10A*           | 18   | 1-20UNEF-2B     | 10,5                | 15,8                | 24,0                | 32,2                | 27,3           |
| VG95234KK12       | MS3057-12A*           | 20, 22                                     | 1 3/16-18NEF-2B | 10,5                | 19,0                | 24,0                | 37,4                | 37,2           |
| VG95234KK16       | MS3057-16A*           | 24, 28                                     | 1 7/16-18NEF-2B | 10,5                | 23,7                | 26,4                | 43,5                | 56,3           |
| VG95234KK20       | MS3057-20A*           | 32   | 1 3/4-18NS-2B   | 12,0                | 31,8                | 28,0                | 51,7                | 83,9           |
| VG95234KK24       | MS3057-24A*           | 36   | 2-18NS-2B       | 13,7                | 34,6                | 29,6                | 57,8                | 109,8          |

\* WB = Cable clamp with cable telescoping bushing

## Telescoping Bushings

Telescoping bushing (used with MS3057A resp. VG95234KK cable clamp) keep dirt, oil and dust out of endbell. Taping or wrapping wires is eliminated since bushing protects wires guided through clamp. Combinations of two bushings may be used to decrease inner diameter for improved sealing.

Material: Polychloroprene



| Shell size | VG95234 Part no. | MS Part no. | Cannon Part no. | d <sub>1</sub> | d <sub>2</sub> | d <sub>3</sub> | l    | Weight g |
|------------|------------------|-------------|-----------------|----------------|----------------|----------------|------|----------|
| 10SL, 12S  | VG95234KT10SL    | -           | 012-8552-000    | 8,0            | 6,6            | 9,9            | 70,0 | 4        |
| 14S        | VG95234KT14S     | -           | 012-8554-000    | 10,9           | 9,1            | 12,7           | 67,0 | 5        |
| 16S, 16    | VG95234KT16      | MS3420-08   | 012-0218-000    | 14,0           | 11,1           | 19,0           | 64,0 | 6        |
| 18         | VG95234KT18      | MS3420-10   | 012-0219-000    | 15,7           | 14,3           | 22,0           | 60,0 | 4        |
| 20, 22     | VG95234KT20      | MS3420-12   | 012-0220-000    | 18,8           | 15,9           | 26,9           | 57,0 | 7        |
| 24         | VG95234KT24      | -           | 012-8555-000    | 21,2           | 16,6           | 26,9           | 57,0 | 13       |
| 28         | VG95234KT28      | -           | 012-8556-000    | 23,6           | 21,5           | 33,3           | 54,0 | 13       |
| 32         | VG95234KT32      | -           | 012-8557-000    | 26,5           | 21,5           | 33,3           | 54,0 | 26       |
|            |                  |             | 012-8558-000    | 31,5           | 26,8           | 40,4           | 51,0 | 26       |
| 36         | VG95234KT32      | -           | 012-8558-000    | 31,5           | 26,8           | 40,4           | 51,0 | 30       |
|            |                  | MS3420-24   | 012-0223-000    | 34,7           | 31,8           | 46,8           | 48,0 | 30       |



## Gaskets

Thickness of gaskets  
 made of Alu-Flex "2" = 0,5 mm  
 made of Polychloropren "1" = 1,0 mm

VG95234 Style DA for front panel mounting  
 VG95234 Style DH for rear panel mounting



### For front panel mounting

| Size   | VG 95234 Part no.  | Part no. Version Polychloropen <sup>1</sup> | Part no. Version Alu-Flex <sup>2</sup> | l ±0,5 | e ±0,2 | d <sub>1</sub> +1 front panel | d <sub>2</sub> +0,5 | Weight g max. |
|--------|--------------------|---|--|--------|--------|-------------------------------|---------------------|---------------|
| 10SL   | VG 95234 DA 10SL-X | 075-8512-000                                | 075-8512-001                           | 25,4   | 18,2   | 15,7                          | 4,2                 | 2             |
| 12S    |                    | 075-8513-000                                | 075-8513-001                           | 28,0   | 20,6   | 18,9                          | 4,2                 | 2             |
| 14S    | VG 95234 DA 14S-X  | 075-8514-000                                | 075-8514-001                           | 30,0   | 23,0   | 22,1                          | 4,2                 | 2             |
| 16/16S | VG 95234 DA 16X    | 075-8515-000                                | 075-8515-001                           | 32,5   | 24,6   | 25,3                          | 4,2                 | 2             |
| 18     | VG 95234 DA 18-X   | 075-8516-000                                | 075-8516-001                           | 35,0   | 27,0   | 28,4                          | 4,2                 | 2             |
| 20     | VG 95234 DA 20-X   | 075-8517-000                                | 075-8517-001                           | 38,0   | 29,4   | 31,6                          | 4,2                 | 2             |
| 22     | VG 95234 DA 22-X   | 075-8518-000                                | 075-8518-001                           | 41,0   | 31,8   | 34,8                          | 4,2                 | 2             |
| 24     | VG 95234 DA 24-X   | 075-8519-000                                | 075-8519-001                           | 44,5   | 34,9   | 38,0                          | 4,2                 | 2             |
| 28     | VG 95234 DA 28-X   | 075-8520-000                                | 075-8520-001                           | 50,8   | 39,7   | 44,3                          | 5,1                 | 2             |
| 32     | VG 95234 DA 32-X   | 075-8521-000                                | 075-8521-001                           | 57,0   | 44,5   | 50,7                          | 5,1                 | 2             |
| 36     | VG 95234 DA 36-X   | 075-8522-000                                | 075-8522-001                           | 63,5   | 49,2   | 57,0                          | 5,1                 | 2             |

### For rear panel mounting

| Size   | VG 95234 Part no.  | Part no. Version Polychloropen <sup>1</sup> | Part no. Version Alu-Flex <sup>2</sup> | l ±0,5 | e ±0,2 | d <sub>1</sub> +1 front panel | d <sub>2</sub> +0,5 | Weight g max. |
|--------|--------------------|---|--|--------|--------|-------------------------------|---------------------|---------------|
| 10SL   | VG 95234 DH 10SL-X | 075-8501-000                                | 075-8501-001                           | 25,4   | 18,2   | 18,2                          | 4,2                 | 2             |
| 12S    |                    | 075-8502-000                                | 075-8502-001                           | 28,0   | 20,6   | 21,4                          | 4,2                 | 2             |
| 14S    | VG 95234 DH 14S-X  | 075-8503-000                                | 075-8503-001                           | 30,0   | 23,0   | 24,6                          | 4,2                 | 2             |
| 16/16S | VG 95234 DH 16X    | 075-8504-000                                | 075-8504-001                           | 32,5   | 24,6   | 27,4                          | 4,2                 | 2             |
| 18     | VG 95234 DH 18-X   | 075-8505-000                                | 075-8505-001                           | 35,0   | 27,0   | 30,8                          | 4,2                 | 2             |
| 20     | VG 95234 DH 20-X   | 075-8506-000                                | 075-8506-001                           | 38,0   | 29,4   | 34,2                          | 4,2                 | 2             |
| 22     | VG 95234 DH 22-X   | 075-8507-000                                | 075-8507-001                           | 41,0   | 31,8   | 37,4                          | 4,2                 | 2             |
| 24     | VG 95234 DH 24-X   | 075-8508-000                                | 075-8508-001                           | 44,5   | 34,9   | 40,9                          | 4,2                 | 2             |
| 28     | VG 95234 DH 28-X   | 075-8509-000                                | 075-8509-001                           | 50,8   | 39,7   | 46,7                          | 5,1                 | 2             |
| 32     | VG 95234 DH 32-X   | 075-8510-000                                | 075-8510-001                           | 57,0   | 44,5   | 53,4                          | 5,1                 | 2             |
| 36     | VG 95234 DH 36-X   | 075-8511-000                                | 075-8511-001                           | 63,5   | 49,2   | 59,6                          | 5,1                 | 2             |

X = insert "1" (electrically not conductive) or "2" (electrically conductive)

# Contacts

## Contacts

Standard contacts and contacts with reduced termination diameter

### Pin contacts



### Finish

- A36 – 5 µm silver plated and passivated
- A176 – 2 µm nickel plated, min. 0,5 µm gold plated

| Contact size | VG95234 Part no. | Wire size mm <sup>2</sup> | AWG   | Part no. with finish Standard: A36 silver plated | Part no. with finish Mod.Code: A176 gold plated | d <sub>1</sub> -0,05 | d <sub>4</sub>         | d <sub>6</sub>        | d <sub>7</sub>        | l <sub>1</sub> ±0,15 | l <sub>3</sub> ±0,5 | Color Code |
|--------------|------------------|---------------------------|-------|--|---|----------------------|------------------------|-----------------------|-----------------------|----------------------|---------------------|------------|
| 10/20        | VG95234P10-002   | 0,5-1,0                   | 20/18 | 030-8585-000                                     | 030-8585-006                                    | 1,04                 | 1,5 <sup>-0,05</sup>   | 1,5 <sup>+0,05</sup>  | 2,4 <sup>-0,05</sup>  | 28,4                 | 4,75                | -          |
|              | VG95234P10-001   | 0,2-0,4                   | 26/22 | 030-8585-010                                     | -   | 1,04                 | 1,5 <sup>-0,05</sup>   | 0,9                   | 2,4 <sup>-0,05</sup>  | 28,4                 | 4,75                | blue       |
| 15S/16S      | VG95234P15S-003  | 0,75-1,5                  | 18/16 | 030-8586-000                                     | 030-8586-006                                    | 1,6                  | 1,75 <sup>-0,1</sup>   | 1,75 <sup>+0,08</sup> | 2,75 <sup>-0,05</sup> | 27,4                 | 3,85                | -          |
|              | VG95234P15S-002  | 0,3-0,6                   | 22/20 | 330-8744-000                                     | 330-8744-006                                    | 1,6                  | 1,75 <sup>-0,1</sup>   | 1,2 <sup>+0,1</sup>   | 2,75 <sup>-0,05</sup> | 27,4                 | 3,85                | red        |
|              | VG95234P15S-001  | 0,14-0,38                 | 22/26 | 030-8586-010                                     | -   | 1,6                  | 1,75 <sup>-0,1</sup>   | 0,9 <sup>+0,05</sup>  | 2,75 <sup>-0,05</sup> | 27,4                 | 3,85                | blue       |
| 15/16        | VG95234P15-003   | 0,75-1,5                  | 18/16 | 030-8587-000                                     | 030-8587-006                                    | 1,6                  | 1,75 <sup>-0,1</sup>   | 1,75 <sup>+0,08</sup> | 2,75 <sup>-0,05</sup> | 31,4                 | 7,9                 | -          |
|              | VG95234P15-002   | 0,3-0,6                   | 22/20 | 330-8659-000                                     | 330-8659-006                                    | 1,6                  | 1,75 <sup>-0,1</sup>   | 1,2 <sup>+0,1</sup>   | 2,75 <sup>-0,05</sup> | 31,4                 | 7,9                 | red        |
|              | VG95234P15-001   | 0,14-0,38                 | 22/26 | 030-8587-030                                     | 030-8587-036                                    | 1,6                  | 1,75 <sup>-0,1</sup>   | 0,9 <sup>+0,05</sup>  | 2,75 <sup>-0,05</sup> | 31,4                 | 7,9                 | blue       |
| 25/12        | VG95234P25-002   | 2,0-3,0                   | 14/12 | 030-8588-000                                     | 030-8588-006                                    | 2,4                  | 3,3 <sup>-0,15</sup>   | 2,5 <sup>+0,1</sup>   | 3,8 <sup>-0,1</sup>   | 37,0                 | 7,9                 | -          |
|              | VG95234P25-001   | 0,75-1,5                  | 18/16 | 030-8588-010                                     | 030-8588-016                                    | 2,4                  | 3,3 <sup>-0,15</sup>   | 1,75 <sup>+0,08</sup> | 3,4 <sup>-0,1</sup>   | 37,0                 | 7,9                 | black      |
|              |                  | 4,0                       | -     | 030-8588-054                                     | -   | 2,4                  | 3,3 <sup>-0,15</sup>   | 2,8 <sup>+0,1</sup>   | 3,8 <sup>-0,1</sup>   | 37,0                 | 7,9                 | -          |
| 60/100/8     | VG95234P8-001    | -                         | 8     | 030-8612-000                                     | 030-8612-006                                    | 3,6                  | 6,25 <sup>-0,15</sup>  | 4,55 <sup>+0,1</sup>  | 6,8 <sup>-0,1</sup>   | 39,6                 | 6,35                | -          |
|              | VG95234P60-002   | 6,0                       | 10    | 030-8589-000                                     | -   | 3,6                  | 6,25 <sup>-0,15</sup>  | 3,5 <sup>+0,1</sup>   | 6,8 <sup>-0,1</sup>   | 39,6                 | 6,35                | yellow     |
|              | VG95234P100-001  | 10,0                      | -     | 030-8590-000                                     | -   | 3,6                  | 6,25 <sup>-0,15</sup>  | 4,8 <sup>+0,1</sup>   | 6,8 <sup>-0,1</sup>   | 39,6                 | 6,35                | -          |
|              | VG95234P60-001   | 2,0-3,0                   | 14/12 | 030-8612-010                                     | -   | 3,6                  | 6,25 <sup>-0,15</sup>  | 2,5 <sup>+0,05</sup>  | 6,8 <sup>-0,1</sup>   | 39,6                 | 6,35                | green      |
| 160/4        | VG95234P4-001    | -                         | 4     | 030-8613-000                                     | -   | 5,75                 | 9,55 <sup>-0,15</sup>  | 7,1 <sup>+0,15</sup>  | 9,55 <sup>-0,1</sup>  | 39,6                 | 6,35                | -          |
|              | VG95234P160-002  | 16,0                      | -     | 030-8591-000                                     | -   | 5,75                 | 9,55 <sup>-0,15</sup>  | 6,2 <sup>+0,15</sup>  | 9,55 <sup>-0,1</sup>  | 39,6                 | 6,35                | -          |
|              |                  | 10,0                      | -     | 030-8591-020                                     | -   | 5,75                 | 9,55 <sup>-0,15</sup>  | 4,8 <sup>+0,1</sup>   | 9,55 <sup>-0,1</sup>  | 39,6                 | 6,35                | -          |
|              | VG95234P160-001  | -                         | 6     | 030-8613-010                                     | -   | 5,75                 | 9,55 <sup>-0,15</sup>  | 5,7 <sup>+0,1</sup>   | 9,55 <sup>-0,1</sup>  | 39,6                 | 6,35                | brown      |
| 500/0        | VG95234P0-001    | -                         | 0     | 030-8614-000                                     | -   | 9,1                  | 13,55 <sup>-0,15</sup> | 11,5 <sup>+0,15</sup> | 14,35 <sup>-0,1</sup> | 41,0                 | 6,35                | -          |
|              | VG95234P500-003  | 50,0                      | -     | 030-8592-000                                     | -   | 9,1                  | 13,55 <sup>-0,15</sup> | 10,7 <sup>+0,15</sup> | 14,35 <sup>-0,1</sup> | 41,0                 | 6,35                | -          |
|              | VG95234P500-001  | 25,0                      | 4     | 030-8614-010                                     | -   | 9,1                  | 13,55 <sup>-0,15</sup> | 7,6 <sup>+0,15</sup>  | 14,35 <sup>-0,1</sup> | 41,0                 | 6,35                | white      |
|              | VG95234P500-002  | 35,0                      | 2     | 030-8614-020                                     | -   | 9,1                  | 13,55 <sup>-0,15</sup> | 9,1 <sup>+0,15</sup>  | 14,35 <sup>-0,1</sup> | 41,0                 | 6,35                | grey       |
|              |                  | 16,0                      | -     | 030-8614-030                                     | -   | 9,1                  | 13,55 <sup>-0,15</sup> | 6,2 <sup>+0,15</sup>  | 14,35 <sup>-0,1</sup> | 41,0                 | 6,35                | -          |

## Contacts

Standard contacts and contacts with reduced termination diameter

Socket contacts

### Finish

- A36 – 5 µm silver plated and passivated
- A176 – 2 µm nickel plated, min. 0,5 µm gold plated



| Contact size | VG95234 Part no. | Wire size mm <sup>2</sup> | AWG   | Part no. with finish Standard: A36 silver plated | Part no. with finish Mod.Code A176 gold plated | d <sub>1</sub>       | d <sub>2</sub> | d <sub>3</sub>        | d <sub>5</sub>        | d <sub>6</sub>        | l <sub>1</sub> ±0,2 | l <sub>3</sub> ±0,1 | Color Code |
|--------------|------------------|---------------------------|-------|--|--|----------------------|----------------|-----------------------|-----------------------|-----------------------|---------------------|---------------------|------------|
| 10/20        | VG95234S10-002   | 0,5-1,0                   | 20/18 | 031-8554-000                                     | 031-8554-006                                   | 2,0 <sup>-0,1</sup>  | 1,07           | 1,5 <sup>-0,05</sup>  | 1,5 <sup>+0,05</sup>  | 2,4 <sup>-0,05</sup>  | 36,8±0,3            | 4,75                | –          |
|              | VG95234S10-001   | 0,2-0,4                   | 26/22 | 031-8554-010                                     | –  | 2,0 <sup>-0,1</sup>  | 1,07           | 1,5 <sup>-0,05</sup>  | 0,9                   | 2,4 <sup>-0,05</sup>  | 36,8±0,3            | 4,75                | blue       |
| 15S/16S      | VG95234S15S-003  | 0,75-1,5                  | 18/16 | 031-8555-110                                     | 031-8555-115                                   | 3,2 <sup>-0,15</sup> | 1,65           | 1,75 <sup>-0,1</sup>  | 1,75 <sup>+0,08</sup> | 2,75 <sup>-0,05</sup> | 29,1                | 3,9                 | –          |
|              | VG95234S15S-002  | 0,3-0,6                   | 22/20 | 031-8688-110                                     | 031-8688-115                                   | 3,2 <sup>-0,15</sup> | 1,65           | 1,75 <sup>-0,1</sup>  | 1,20 <sup>+0,1</sup>  | 2,75 <sup>-0,05</sup> | 29,1                | 3,9                 | red        |
|              | VG95234S15S-001  | 0,14-0,38                 | 22/26 | 031-8555-130                                     | –  | 3,2 <sup>-0,15</sup> | 1,65           | 1,75 <sup>-0,1</sup>  | 0,90 <sup>+0,05</sup> | 2,75 <sup>-0,05</sup> | 29,1                | 3,9                 | blue       |
| 15/16        | VG95234S15-003   | 0,75-1,5                  | 18/16 | 031-8556-110                                     | 031-8556-115                                   | 3,2 <sup>-0,15</sup> | 1,65           | 1,75 <sup>-0,1</sup>  | 1,75 <sup>+0,08</sup> | 2,75 <sup>-0,05</sup> | 37,8                | 7,9                 | –          |
|              | VG95234S15-002   | 0,3-0,6                   | 22/20 | 031-8639-120                                     | 031-8639-115                                   | 3,2 <sup>-0,15</sup> | 1,65           | 1,75 <sup>-0,1</sup>  | 1,2 <sup>+0,1</sup>   | 2,75 <sup>-0,05</sup> | 37,8                | 7,9                 | red        |
|              | VG95234S15-001   | 0,14-0,38                 | 22/26 | 031-8556-130                                     | –  | 3,2 <sup>-0,15</sup> | 1,65           | 1,75 <sup>-0,1</sup>  | 0,9 <sup>+0,05</sup>  | 2,75 <sup>-0,05</sup> | 37,8                | 7,9                 | blue       |
| 25/12        | VG95234S25-002   | 2,0-3,0                   | 14/12 | 031-8557-000                                     | 031-8557-006                                   | 4,8 <sup>-0,1</sup>  | 2,45           | 3,3 <sup>-0,1</sup>   | 2,5 <sup>+0,1</sup>   | 3,8 <sup>-0,1</sup>   | 37,0                | 7,9                 | –          |
|              | VG95234S25-001   | 0,75-1,5                  | 18/16 | 031-8557-020                                     | 031-8557-026                                   | 4,8 <sup>-0,1</sup>  | 2,45           | 3,3 <sup>-0,1</sup>   | 1,75 <sup>+0,08</sup> | 3,4 <sup>-0,1</sup>   | 37,0                | 7,9                 | black      |
|              | –                | 4,0                       | –     | 031-8557-010                                     | –  | 4,8 <sup>-0,1</sup>  | 2,45           | 3,3 <sup>-0,1</sup>   | 2,8 <sup>+0,1</sup>   | 3,8 <sup>-0,1</sup>   | 37,0                | 7,9                 | –          |
|              | –                | 0,3-0,6                   | 22/20 | 031-8557-040                                     | –  | 4,8 <sup>-0,1</sup>  | 2,45           | 3,3 <sup>-0,1</sup>   | 1,2 <sup>+0,1</sup>   | 2,75 <sup>-0,1</sup>  | 37,0                | 7,9                 | –          |
| 60/100/8     | VG95234S8-001    | –                         | 8     | 031-8519-000                                     | 031-8519-006                                   | 6,5 <sup>-0,2</sup>  | 3,65           | 6,25 <sup>-0,2</sup>  | 4,55 <sup>+0,1</sup>  | 6,8 <sup>-0,1</sup>   | 40,1                | 6,35                | –          |
|              | VG95234S60-002   | 6,0                       | 10    | 031-8558-000                                     | –  | 6,5 <sup>-0,2</sup>  | 3,65           | 6,25 <sup>-0,2</sup>  | 3,5 <sup>+0,1</sup>   | 6,8 <sup>-0,1</sup>   | 40,1                | 6,35                | yellow     |
|              | VG95234S100-001  | 10,0                      | –     | 031-8559-000                                     | –  | 6,5 <sup>-0,2</sup>  | 3,65           | 6,25 <sup>-0,2</sup>  | 4,8 <sup>+0,1</sup>   | 6,8 <sup>-0,1</sup>   | 40,1                | 6,35                | –          |
|              | VG95234S60-001   | 2,0-3,0                   | 14/12 | 031-8519-010                                     | –  | 6,5 <sup>-0,2</sup>  | 3,65           | 6,25 <sup>-0,2</sup>  | 2,5 <sup>+0,05</sup>  | 6,8 <sup>-0,1</sup>   | 40,1                | 6,35                | green      |
| 160/4        | VG95234S4-001    | –                         | 4     | 031-8520-000                                     | –  | 8,6 <sup>-0,2</sup>  | 5,8            | 9,55 <sup>-0,2</sup>  | 7,1 <sup>+0,15</sup>  | 9,55 <sup>-0,1</sup>  | 40,1                | 6,35                | –          |
|              | VG95234S160-002  | 16,0                      | –     | 031-8560-000                                     | –  | 8,6 <sup>-0,2</sup>  | 5,8            | 9,55 <sup>-0,2</sup>  | 6,2 <sup>+0,15</sup>  | 9,55 <sup>-0,1</sup>  | 40,1                | 6,35                | –          |
|              | –                | 10,0                      | –     | 031-8560-020                                     | –  | 8,6 <sup>-0,2</sup>  | 5,8            | 9,55 <sup>-0,2</sup>  | 4,8 <sup>+0,1</sup>   | 9,55 <sup>-0,1</sup>  | 40,1                | 6,35                | –          |
|              | VG95234S160-001  | –                         | 6     | 031-8520-010                                     | –  | 8,6 <sup>-0,2</sup>  | 5,8            | 9,55 <sup>-0,2</sup>  | 5,7 <sup>+0,15</sup>  | 9,55 <sup>-0,1</sup>  | 40,1                | 6,35                | brown      |
| 500/0        | VG95234S0-001    | –                         | 0     | 031-8521-000                                     | –  | 13,2 <sup>-0,2</sup> | 9,15           | 13,55 <sup>-0,2</sup> | 11,5 <sup>+0,15</sup> | 14,35 <sup>-0,1</sup> | 41,6                | 6,35                | –          |
|              | VG95234S500-003  | 50,0                      | –     | 031-8561-000                                     | –  | 13,2 <sup>-0,2</sup> | 9,15           | 13,55 <sup>-0,2</sup> | 10,7 <sup>+0,15</sup> | 14,35 <sup>-0,1</sup> | 41,6                | 6,35                | –          |
|              | VG95234S500-001  | 25,0                      | 4     | 031-8521-010                                     | –  | 13,2 <sup>-0,2</sup> | 9,15           | 13,55 <sup>-0,2</sup> | 7,6 <sup>+0,15</sup>  | 14,35 <sup>-0,1</sup> | 41,6                | 6,35                | white      |
|              | VG95234S500-002  | 35,0                      | 2     | 031-8521-020                                     | –  | 13,2 <sup>-0,2</sup> | 9,15           | 13,55 <sup>-0,2</sup> | 9,1 <sup>+0,15</sup>  | 14,35 <sup>-0,1</sup> | 41,6                | 6,35                | grey       |
|              | –                | 16,0                      | –     | 031-8521-030                                     | –  | 13,2 <sup>-0,2</sup> | 9,15           | 13,55 <sup>-0,2</sup> | 6,2 <sup>+0,15</sup>  | 14,35 <sup>-0,1</sup> | 41,6                | 6,35                | –          |

## Termination Tools

for pin contacts according VG95234 and for Cannon contacts with reduced termination size.

| Contact size | Wire size       |         | Hand crimp tool Type                                | Crimp die for M22520-1-01  | Pneumatic crimp tool <sup>1)</sup> |   | Universal-type                | Turret for Universal type |
|--------------|-----------------|---------|---|----------------------------|------------------------------------|---|-------------------------------|---------------------------|
|              | mm <sup>2</sup> | AWG     |   |                            | Standard type                      | Turret for Standard type                |                               |                           |
| 10/20        | 0,2 – 1,0       | 20 – 24 | M22520-1-01<br>Hand crimp tool (eight indent crimp) | 600 325<br>600 325         | Eight indent crimp<br>612 871      | 600 098<br>600 098                      | Eight indent crimp<br>612 141 | 608 325<br>608 325        |
| 15S/16S      | 0,14 – 1,5      | 16 – 26 |   | TH 452<br>TH 452           |                                    | table device with foot pedal<br>611 380 |                               | 600 082<br>600 082        |
| 15/16        | 0,14 – 1,5      | 16 – 26 |   | TH 452<br>TH 452           | 604 292<br>604 292                 |   | TH 452<br>TH 452              |                           |
| 25/12        | 0,75 – 4,0      | 12 – 18 |   | TH 452<br>TH 452<br>TH 452 | 600 099<br>600 099<br>600 099      | TH 452<br>TH 452<br>TH 452              |                               |                           |

| Contact size | Wire size mm <sup>2</sup> | AWG    | Hydraulic basic equipment   | Crimp tool (2 of each required)<br>6-kt Crimp die |
|--------------|---------------------------|--------|---|---|
| 60/8<br>100/ | 10,0 – 2,0                | 8 – 14 | Electro-hydraulic tool *<br>HK12EL (order number: 121586-5075)    | CT 317-8678-000                                   |
| 160/4        | 16,0 – 10,0               | 4 – 6  | Hand operated hydraulic tool<br>HK120 (order number: 121586-5077) | CT 317-8678-001                                   |
| 500/0        | 50,0 – 16,0               | 0 – 4  |   | CT 317-8678-002                                   |

### Notes

- For large series production, semi-automatic crimp machine Type HACS-IV-MSXX upon request
- For insertion and extraction of the contacts and for connector assembly, see Assembly Instructions MIL-C-5015/VG95234
- Standard contacts acc. to MIL-C-5015/VG95234

\* Datasheet available upon request

To insert the socket contact of size 15S/16S, 15/16/25 and 12, the following guiding pins are to be used:

| Part Nr.     | Contact size |        |
|--------------|--------------|--------|
|              | AWG          | metric |
| 226-1017-000 | 16S/16       | 15S/15 |
| 226-1018-000 | 12           | 25     |

## Termination Tools

for pin contacts according VG95234 and Cannon contacts with reduced termination diameter.

| Contact size | Wire size       |         | Hand crimp tool Type                                     | Crimp die for M22520-1-01 | Pneumatic crimp tool <sup>1)</sup>        |                          | Universal type                             | Turret for Universal type |
|--------------|-----------------|---------|--|---------------------------|---|--------------------------|--|---------------------------|
|              | mm <sup>2</sup> | AWG     |  |                           | Standard type                             | Turret for Standard type |  |                           |
| 10/20        | 0,2-1,0         | 18 – 24 | M22520-1-01<br>Eight indent tool<br>(eight indent Crimp) | 600 325<br>600 325        | Eight indent crimp<br>612 871             | 600 098<br>600 098       | Eight indent crimp<br>612 141              | 600 325<br>600 325        |
| 15S/16S      | 0,2-1,0         | 16 – 22 |  | TH 452<br>611 380         | Table device<br>and foot pedal<br>611 380 | 600 083<br>611 380       | table device<br>with foot pedal<br>611 380 | TH 452                    |
| 15/16        | 0,2-1,0         | 16 – 22 |  | TH 452                    |   | 604 081                  |  | TH 452                    |
| 25/12        | 0,2-1,0         | 12 – 18 |  | TH 452                    |   | 600 099                  |  | TH 452                    |

| Contact size | Wire size mm <sup>2</sup> | AWG    | Hydraulic basic equipment   | Crimp tool (2 of each required)<br>6-kt Crimp die |
|--------------|---------------------------|--------|---|---|
| 60/8<br>100/ | 10 – 2                    | 8 – 14 | Electro-hydraulic tool *<br>HK12EL (order number: 121586-5075)    | CT 317-8678-000                                   |
| 160/4        | 16 – 10                   | 4 – 6  | Hand operated hydraulic tool<br>HK120 (order number: 121586-5077) | CT 317-8678-001                                   |
| 500/0        | 50 – 14                   | 0 – 4  |   | CT 317-8678-002                                   |

### Notes

1. For large series production, semi-automatic crimp machine  
Type HACS-IV-MSXX upon request
  2. For insertion and extraction of the contacts and for connector assembly,  
see Assembly Instructions MIL-C-5015/VG95234
  3. Standard contacts acc. MIL-C-5015/VG95234
- \* Datasheet available upon request

# Product Safety Information

**THIS NOTE MUST BE READ IN CONJUNCTION WITH THE PRODUCT DATA SHEET/CATALOG. FAILURE TO OBSERVE THE ADVICE IN THIS INFORMATION SHEET AND THE OPERATING CONDITIONS SPECIFIED IN THE PRODUCT DATA SHEET/ CATALOG COULD RESULT IN HAZARDOUS SITUATIONS.**

## 1. MATERIAL CONTENT AND PHYSICAL FORM

Electrical connectors do not usually contain hazardous materials. They contain conducting and non-conducting materials and can be divided into two groups.

- a) Printed circuit types and low cost audio types which employ all plastic insulators and casings.
- b) Rugged, Fire Barrier and High Reliability types with metal casings and either natural rubber, synthetic rubber, plastic or glass insulating materials. Contact materials vary with type of connector and also application and are usually manufactured from either: Copper, copper alloys, nickel, alumel, chromel or steel. In special applications, other alloys may be specified.

## 2. FIRE CHARACTERISTICS AND ELECTRIC SHOCK HAZARD

**There is no fire hazard when the connector is correctly wired and used within the specified parameters. Incorrect wiring or assembly of the connector or careless use of metal tools or conductive fluids, or transit damage to any of the component parts may cause electric shock or burns. Live circuits must not be broken by separating mated connectors as this may cause arcing, ionization and burning.** Heat dissipation is greater at maximum resistance in a circuit. Hot spots may occur when resistance is raised locally by damage, e.g. cracked or deformed contacts, broken strands of wire. Local overheating may also result from the use of the incorrect application tools or from poor quality soldering or slack screw terminals. Overheating may occur if the ratings in the product Data Sheet/Catalog are exceeded and can cause breakdown of insulation and hence electric shock. If heating is allowed to continue it intensifies by further increasing the local resistance through loss of temper of spring contacts, formation of oxide film on contacts and wires and leakage currents through carbonization of insulation and tracking paths. Fire can then result in the presence of combustible materials and this may release noxious fumes. Overheating may not be visually apparent. Burns may result from touching overheated components.

## 3. HANDLING

Care must be taken to avoid damage to any component parts of electrical connectors during installation and use. Although there are normally no sharp edges, care must be taken when handling certain components to avoid injury to fingers. Electrical connectors may be damaged in transit to the customers, and damage may result in creation of hazards. Products should therefore be examined prior to installation/use and rejected if found to be damaged.

## 4. DISPOSAL

Incineration of certain materials may release noxious or even toxic fumes.

## 5. APPLICATION

Connectors with exposed contacts should not be selected for use on the current supply side of an electrical circuit, because an electric shock could result from touching exposed contacts on an unmated connector. Voltages in excess of 30 V ac or 42.5 V dc are potentially hazardous and care should be taken to ensure that such voltages cannot be transmitted in any way to exposed metal parts of the connector body. The connector and wiring should be checked, before making live, to have no damage to metal parts or insulators, no solder blobs, loose strands, conducting lubricants, swarf, or any other undesired conducting particles. Circuit resistance and continuity check should be made to make certain that there are no high resistance joints or spurious conducting paths. Always use the correct application tools as specified in the Data Sheet/Catalog. Do not permit untrained personnel to wire, assemble or tamper with connectors. For operation voltage please see appropriate national regulations.

## IMPORTANT GENERAL INFORMATION

**(i) Air and creepage paths/Operating voltage.** The admissible operating voltages depend on the individual applications and the valid national and other applicable safety regulations.

For this reason the air and creepage path data are only reference values. Observe reduction of air and creepage paths due to PC board and/or harnessing.

## (ii) Temperature

All information given are temperature limits. The operation temperature depends on the individual application.

## (iii) Other important information

Cannon continuously endeavors to improve their products. Therefore, Cannon products may deviate from the description, technical data and shape as shown in this catalog and data sheets.

“Engineered for life” is a registered trademark of ITT Industries, ©2005. All other trademarks or registered trademarks are property of their respective owners. All data subject to change without notice.

## Product Warranty

ITT Cannon, a Division of ITT Industries, Inc. manufactures the highest quality products available in the marketplace; however these products are intended to be used in accordance with the specifications in this publication. Any use or application that deviates from the stated operating specifications is not recommended and may be unsafe. No information and data contained in this publication shall be construed to create any liability on the part of Cannon. Any new issue of this publication shall automatically invalidate and supersede any and all previous issues. A limited warranty applies to Cannon products. Except for obligations assumed by Cannon under this warranty, Cannon shall not be liable for any loss, damage, cost of repairs, incidental or consequential damages of any kind, whether or not based on express or implied warranty, contract, negligence or strict liability arising in connection with the design, manufacture, sale, use or repair of the products. Product availability, prices and delivery dates are exclusively subject to our respective order confirmation form; the same applies to orders based on development samples delivered. This publication is not to be construed as an offer. It is intended merely as an invitation to make an offer. By this publication, Cannon does not assume responsibility or any liability for any patent infringements or other rights of third parties which may result from its use. Reprinting this publication is generally permitted, indicating the source. However, Cannon's prior consent must be obtained in all cases.

ITT ...

providing a comprehensive offering of connectivity solutions.

In addition to connector products, we provide a complete line of electronic components and value-added solutions.

## CONNECTOR PRODUCTS

Circular  
Compact flash  
D-Subminiature  
Fiber optics  
Filter  
Microminiature

Mobile  
Rack & Panel  
RF  
USB  
Zero insertion force  
Smart Cards



## SWITCH PRODUCTS



Top/side actuated tact  
Low profile SMT  
Navigation / scrolling switches  
Toggle, rocker, pushbutton, DIP, slide, snap,  
switchlock, rotary, thumbwheel

## KEYPADS / PRECISION POLYMERS

Rubber and In Mold Decoration (IMD) products  
Wide range of cosmetic options  
Integration of decorated and metalized plastic keytops  
Multiple PILL and contact options  
Precision molded polymeric solutions



## DOMES ARRAYS / EL LAMPS

Modular assembly options include: ESD shielding,  
keypads, EL backlighting, rigid or flexible circuits  
Complete design, engineering and test capabilities  
Low, mid and high volume production capabilities



## INTERFACE CONTROLS

From multi-function grips to sophisticated control systems,  
hall effect products and front panel assemblies  
Electronics and software engineering development  
Worldwide design and manufacturing  
High-mix production capabilities  
Global sourcing and supply chain management





### Connector Product Locations

With manufacturing facilities, sales representatives and distributors located worldwide, please visit our website at [www.ittcannon.com](http://www.ittcannon.com) for a complete listing and to find the office nearest you.

#### GERMANY

Cannonstrasse 1  
Weinstadt, 71384  
phone: 49.7151.699.0  
fax: 49.7151.699.217

#### HONG KONG

Unit 901 & 912, West Tower  
Shun Tak Center  
168-200 Connaught Road  
Central  
phone: 852.2732.2720  
fax: 852.2732.2919

#### ITALY

Via Pietro Panzeri 10  
Milano, 20123  
phone: 39.2.58180.1  
fax: 39.2.8372036

#### UK

Jays Close, Viabes Estate  
Basingstoke, RG22 4BA  
phone: 44.1256.311200  
fax: 44.1256.323356

#### USA

666 East Dyer Road  
Santa Ana, CA 92705  
toll free: 1.800.854.3028  
phone: 1.714.557.4700  
fax: 1.714.628.2142

## Cannon CA-Bayonet Connectors

In Accordance with VG95234



"Engineered for life" is a registered trademark of ITT Industries. ©2005. All other trademarks or registered trademarks are property of their respective owners. All data subject to change without notice.



## X-ON Electronics

Largest Supplier of Electrical and Electronic Components

*Click to view similar products for ITT manufacturer:*

Other Similar products are found below :

[BKAF3-68102-25](#) [DBMM-21W1S](#) [MS3102R32-8S](#) [MS3102E32-7S](#) [MS3102R328SX](#) [MS3102E32-8S](#) [MS3102E327SX](#) [MS3102R32-8SW](#)  
[MS3102R328SY](#) [MS3102E328SW](#) [MS3102E328SX](#) [MS3102E328SY](#) [MS3102E328SZ](#) [MS3102R328SZ](#) [MS3101E1811SX](#)  
[MS3101E1811SY](#) [MS3101R18-11S](#) [MS3101R1811SX](#) [MS3101R1811SY](#) [CA3106E28-51S-B-F80-A176](#) [CB0-24-10SSA232](#)  
[MS3101F1811SX](#) [MS3101F1811SY](#) [CA3106E28-51PBF80G16](#) [110238-0195](#) [MDM21SH003M7](#) [MS3100F24-11PW](#) [MS3100E2410SZ](#)  
[MS3100F24-10SZ](#) [MS3100F24-11P](#) [MS3100E2411P](#) [MS3100E2411PW](#) [MS3100E2411PX](#) [MS3100E2411PY](#) [MS3100E2411PZ](#)  
[MS3100F2411PX](#) [MS3100F2411PY](#) [MS3100F2411PZ](#) [MS3106F2422SY](#) [MS3106E24-22SY](#) [MS3100F2422PW](#) [MS3100F2422PX](#)  
[MS3106E24-22SX](#) [MS3106E24-10S](#) [MS3100F2422SW](#) [MS3100F2422SY](#) [MS3100F2422SX](#) [MS3100E2422PW](#) [MS3100E2422PX](#)  
[MS3100E2422PY](#)