

Cannon

# CA Bayonet Connectors

In Accordance with VG95234

*IP69K Compliant*



**ITT**

ENGINEERED FOR LIFE



Dimensions shown in mm  
Specifications and dimensions subject to change

## Interconnect Technologies & Solutions

For over 90 years, ITT has been developing innovative solutions for harsh environment applications. We have a proven track record of demonstrating our expertise and commitment to the industrial industry, offering the broadest portfolio of interconnect products.

Our interconnect range include sealed circulars, plastic and metal shell bayonet coupling circulars, miniature metal shell circulars, PC Board header connectors and sensor and direct device connectors. ITT is also a systems supplier, providing value-added module and harness assemblies.

In addition to our CA Bayonet series, we also offer these connectivity solutions:

### Environmentally Sealed & Harsh Environments



Cannon MIL-DTL-38999

High density contact arrangements, corrosion-resistant shells, rear release crimp snap-in contacts, operates under severe high temperature vibration testing.



Cannon Trident

Versatile range of electrical connectors based on a standard contact design. Options include; industrial grade, harsh environment and shielded circulars.

#### Table of Contents

<b>Product Selection Guide</b>	4-5
<b>Introduction</b>	6
<b>CA VG/CA Bayonet</b>	6
<b>Technical Data</b>	7
<b>Mechanical Features</b>	8
<b>Mounting Holes &amp; Dimensions</b>	9
<b>How to Order</b>	11
<b>Contact Arrangement</b>	13
<b>Connector Dimensions</b>	31
<b>Coupling Dimensions</b>	46
<b>CA IP69K</b>	
<b>General Information</b>	47
<b>How to Order</b>	48
<b>Electrical Data</b>	50
<b>Connector Dimensions</b>	51
<b>Accessories</b>	53
<b>Contacts</b>	59
<b>Part Number Search</b>	64-65
<b>Product Safety Information</b>	66



Cannon KPT / KPSE

Environmentally sealed miniature circular connectors available in two versions: KPT (solder contact) and KPSE (high performance crimp contact). Intermateable and intermountable with all MIL-C-26482 connectors and is available with many materials, finishes and configurations.

Connector Series Selection Table		Sure Seal	CLC	SLC	SLE	APD	Trident Rectangular	Trident Circular	MS E/F/R
									
General	Industrial/Commercial	○	○	○	○	○	○	○	○
	Military	-	-	-	-	-	-	-	○
	Standards/Associated Specifications	-	SAE J2030 USCar	SAE J2030 USCar	SAE J2030 USCar	ISO 15170	UL 1977 NFF 61-030 (TFR)	UL 1977 EN 61984	MIL-DTL-5015 VG 95342
Electrical	Number of Circuits	2 to 10	2 & 4	5, 8, 10 & 15	19 & 28	1 to 51	2 to 36	4 to 48	1 to 65
	Max. Operating Voltage	48 V DC	300 V AC	300 V AC	300 V AC	48 V DC High Voltage: 500 V DC/AC	250 V AC	250 V AC High Voltage: 500 V DC/AC	50 V DC
	Dielectric Withstanding Voltage (at sea level)	1200 V AC	1000 V AC	1000 V AC	1000 V AC	1000 V AC High Voltage: 3500 V AC	2000 V AC	2000 V AC High Voltage: 3500 V AC	3000 V AC
	Max. Current Rating @ 40°C	17 A	5 A	13 A	13 A	245 A	13 A	30 A	245 A
Mechanical	EMI/RFI Shielding	-	-	-	-	-	-	○	○
	Wire Gauge Range AWG	20 to 14	20 to 16	20 to 16	20 to 16	22 to 0	26 to 14	26 to 12	26 to 0
	Wire Gauge Range mm <sup>2</sup>	0,4 - 1,5 mm <sup>2</sup>	0,50 - 1,0 mm <sup>2</sup>	0,50 - 1,0 mm <sup>2</sup>	0,50 - 1,0 mm <sup>2</sup>	0,35 - 50 mm <sup>2</sup>	0,14 - 2,5 mm <sup>2</sup>	0,14 - 4,0 mm <sup>2</sup>	0,14 - 50 mm <sup>2</sup>
	Power & Signal Layouts	-	-	-	-	-	-	○	○
	Mating Cycles (max.)	100	25	25	25	50	500	500	100
	Type of Coupling	Ring Snap	Clip Lock	Snap Lock	Snap Lock	Bayonet	Snap Lock	Bayonet	Thread
Environmental	Mechanical Coding	-	-	-	○	○	○	○	-
	Environmental Sealing (mated condition)	IP 68 (1 bar / 12h)	IP 68	IP 68	IP 68	IP67 IP69k	IP 20	IP 67	IP 68
	Operating Temperature	-40°C to 105°C -40°F to 221°F	-40°C to 150°C -40°F to 302°F	-40°C to 150°C -40°F to 302°F	-40°C to 125°C -40°F to 257°F	-40°C to 125°C -40°F to 257°F	-55°C to 105°C -67°F to 221°F	-55°C to 125°C -67°F to 257°F	-55°C to 125°C -67°F to 257°F
	Shock Test (g's)	50	100	100	100	-	50	50	50
	Max. Vibration Resistance	10 - 55 Hz 1,5 mm	100 m/s <sup>2</sup> 10 g's	100 m/s <sup>2</sup> 10 g's	100 m/s <sup>2</sup> 10 g's	300 m/s <sup>2</sup> 30 g's	100 m/s <sup>2</sup> 10 g's	100 m/s <sup>2</sup> 10 g's	100 m/s <sup>2</sup> 10 g's
	Individual Wire Sealing	○	○	○	○	○	-	○	○
	Cable Jacket Sealing	○	-	-	-	○	-	○	○
Shell Plating	Shell Material	Nitril-Butadien Elastomer	Thermoplastic	Thermoplastic	Thermoplastic	Polyamide Plastic	Polyamide Plastic	Black Nylon or Zinc Alloy	Aluminum Alloy
	RoHS Nickel (48h salt spray)	-	-	-	-	-	-	○	○
	Cadmium (olive, 500h)	-	-	-	-	-	-	-	○
	RoHS Zinc Cobalt (black, 200h)	-	-	-	-	-	-	-	○
	Zinc Cobalt (green, 200h)	-	-	-	-	-	-	-	-
	RoHS Zinc Nickel (blue, 500h) BLUE GENERATION®	-	-	-	-	-	-	-	-
Contacts	Contact Plating	Tin or Silver	Tin or Gold	Tin or Gold	Tin or Gold	Tin, Silver or Gold	Tin or Gold	Tin or Gold	Silver or Gold
	Crimp, machined	○	○	○	○	○	○	○	-
	Crimp, stamped	○	○	○	○	○	○	○	-
	Solder	-	-	-	-	○	○	○	○
	Printed Circuit Solder	-	○	○	○	○	○	○	○
	Co-Ax	-	-	-	-	-	○	○	-
	Fiber Optic	-	-	-	-	-	-	-	-
	First-Mate Last-Break	-	-	-	-	-	○	○	○

○ Available - Not available



Dimensions shown in mm  
Specifications and dimensions subject to change

www.ittcannon.com

CA Bayonet	CA-INDUSTRIAL	CA Triple Thread	CGL	KPT / KPSE	KPTC	PV	KJL	KJ	KJA
○	○	○	○	○	○	-	○	○	○
○	-	-	-	○	○	○	○	○	○
VG 95234	-	ISO 16750 VG 95234	DIN/VDE 0627 5.4.3 IEC 512-25-1 DIN/VDE 0100 Part 410	MIL-DTL-26482 Series 1, VG 95328	MIL-DTL-26482 Series 1, VG 95328	MIL-DTL 26482 Series 2	MIL-DTL-38999 Series I	MIL-DTL-38999 Series II	MIL-DTL-38999 Series III
1 to 85	2 to 55	1 to 85	3 to 11	2 to 61	2 to 61	3 to 61	3 to 128	3 to 128	3 to 128
50 V DC	50 V DC	50 V DC	700 V DC	50 V DC	50 V DC	500 V AC	1250 V AC	1250 V AC	1250 V AC
3000 V AC	2000 V AC	3000 V AC	7200 V AC	2300 V AC	2300 V AC	2300 V AC	2300 V AC	2300 V AC	2300 V AC
245 A	30 A	245 A	100 A	22 A	22 A	23 A	23 A	23 A	23 A
○	○	○	○	○	○	○	○	○	○
26 to 0	26 to 12	26 to 0	15 to 3	24 to 16	24 to 16	24 to 12	28 to 12	28 to 12	28 to 12
0,14 - 50 mm <sup>2</sup>	0,14 - 4,0 mm <sup>2</sup>	0,14 - 50 mm <sup>2</sup>	1,5 - 25 mm <sup>2</sup>	0,21 - 1,91 mm <sup>2</sup>	0,4 - 2,0 mm <sup>2</sup>	0,4 - 5,0 mm <sup>2</sup>	0,45 - 5,0 mm <sup>2</sup>	0,45 - 5,0 mm <sup>2</sup>	0,45 - 5,0 mm <sup>2</sup>
○	○	○	○	-	-	○	○	○	○
500	200	500	500	500	500	500	500	500	500
Reverse Bayonet	Reverse Bayonet	Triple Thread	Bayonet	Bayonet	Bayonet	Bayonet	Bayonet	Bayonet	Triple Thread
○	○	○	○	○	○	-	-	-	-
IP68 (1 bar / 16h) IP69k	IP68 (1 bar / 16h) IP69k	IP68 (1 bar / 16h) IP69k	IP 67	IP 68 (0,2 bar / 48h)	IP 68 (0,2 bar / 48h)	Environmental resistant acc. to EIA-364-02	Environmental resistant acc. to EIA-364-02	Environmental resistant acc. to EIA-364-02	Environmental resistant acc. to EIA-364-02
-55°C to 125°C -67°F to 257°F	-55°C to 125°C -67°F to 257°F	-55°C to 125°C -67°F to 257°F	-50°C to 140° C -58°F to 284°F	-55°C to 125°C -67°F to 257°F	-55°C to 125°C -67°F to 257°F	-55°C to 200°C -67°F to 392°F	-65°C to 200°C -85°F to 392°F	-65°C to 200°C -85°F to 392°F	-65°C to 200°C -85°F to 392°F
50	50	50	50	50	50	10	300	300	300
200 m/s <sup>2</sup> 20 g's	100 m/s <sup>2</sup> 10 g's	300 m/s <sup>2</sup> 30 g's	300 m/s <sup>2</sup> 30 g's	200 m/s <sup>2</sup> 20 g's	200 m/s <sup>2</sup> 20 g's	200 m/s <sup>2</sup> 20 g's	300 m/s <sup>2</sup> 30 g's	10Hz - 500Hz Random: 43,7g	600m/s <sup>2</sup> 60g'
○	-	-	-	○	○	○	○	○	○
○	○	○	○	○	○	○	○	○	○
Aluminum Alloy	Aluminum Alloy	Aluminum Alloy	Aluminum Alloy	Aluminum Alloy	Aluminum Alloy	Aluminum Alloy	Aluminum Alloy	Aluminum Alloy	Aluminum Alloy
○	○	○	○	○	○	○	○	○	○
○	-	○	-	○	○	○	○	○	○
○	-	○	-	○	○	-	-	-	○
○	-	○	-	○	○	-	-	-	-
○	○	○	○	○	○	-	-	-	-
Silver or Gold	Tin or Gold	Silver or Gold	Silver or Gold	Gold	Gold	Gold	Gold	Gold	Gold
○	-	○	○	○ (KPSE)	○	○	○	○	○
-	○	-	-	-	-	-	-	-	-
○	-	○	○	○ (KPT)	○	-	-	-	○
○	-	○	-	○	○	○	○	○	○
-	-	-	-	○	-	○	○	○	○
-	-	-	-	-	-	○	○	○	○
○	-	○	-	○	○	-	-	-	-

Dimensions shown in mm  
Specifications and dimensions subject to change



## Introduction

Cannon CA-Bayonet series was designed in accordance with the VG95234 specification. This versatile and highly reliable connector series is an improvement on the well established MIL-C-5015 series. CA-Bayonet has a proven “reverse bayonet” coupling design that offers exceptional vibration protection, by a simple 120° turn.

Initially designed for aircraft and airborne applications, these rugged connectors are used in the electrical equipment of various off-road vehicles, construction machinery, industrial devices, railroad and military wheelers.

Connectors in accordance with VG95234 are interchangeable with the corresponding MIL-C-5015 connectors. Both connector lines feature the same shell dimensions and contacts layouts. However, due to the different coupling systems (MIL-C-5015 threaded coupling, VG95234 bayonet coupling) they are not intermateable.

## Advantages

- rugged shell design
- environmental
- bayonet coupling for easy mating and unmating
- vibration proof
- waterproof up to IP68, (10 meters / 35 feet or 1 bar for 16 h) and IP69k (Jet water)

Cannon has the complete VG95234 program available and, in addition, many other types which exceed the requirements of VG95234 and MIL-C-5015.

### Attention:

Metal shell connectors which may be touched are not suitable for mains power.

### Restrictions:

- \* European Community “Old Car” directive (2000/53/EG)
- \* European Community Waste Electrical and Electronic Equipment (WEEE) 2000/0158
- \* European Community restrictions of use of certain hazardous substances in WEEE (ROS) (2000/0159)

## Connector Design

Due to the rugged shell made of an aluminium alloy, these connectors withstand most severe conditions. Olive drab chromate coating over cadmium plating protects the surface of the shell.

Cannon offers three plating solutions to customers refusing cadmium plating. Zinc cobalt green offers similar properties like cadmium plating while zinc cobalt black and zinc nickel is RoHS compliant.

Over 180 contact arrangements are available for 1 to 65 circuits and up to 245 A per unit.

The insulators are made of high quality polychloroprene and withstand temperatures from -67°/+257°F (-55/125°C). This material is self-extinguishing, resistant against hydraulic fluids, jet fuel, diesel fuel, gasolines, lubricants, brake and fire extinguisher fluids (short wetting only). In case of lifetime moistening ITT Cannon offers FKM insulators as an alternative.

The contacts are made of copper alloy plated with a hard silver finish guarantee at least 500 mating cycles. There are solder, crimp and PCB contacts in place. The crimp contacts offer a comprehensive range of termination reductions. All solder contacts feature a special passivation to comply with ROHS requirements. The crimp contacts allow highly reliable crimping with wires when using the recommended tools according to VG95234. Crimp contacts can be exchanged at least five times still preserving specified contact retention.

The coupling unit is featured by the Cannon roller bolts made of stainless steel actually rolling down the mating ramps, thus reducing coupling force by the operator. In addition, the Cannon design employs two coupling nut versions for different application cases, with and without wavespring and washer. The version without wavespring guarantees perfect sealing while the other version stands up to high vibration levels. The bayonet design allows fast and easy coupling and uncoupling. An audible control by metallic sound and visual control by colour-marked snap-in position offer additional coupling security.

VG connectors are basically designed for single wire harnessing. For full environmental sealing each conductor is sealed completely within the grommet. However, Cannon offers as an alternative O-ring sealed PG and metric gland adaptors for faster harnessing standing up to the same sealing level than the VG types.

For highest environmental sealing levels the Universal Endbell is available. Connectors equipped with this Endbell and a receptacle with O-ring option reach a sealing up to IP69k according to

DIN 40050. So the CA-Bayonet is equipped for applications where water jets are used for cleaning the equipment. Universal Endbell has simple to harness shielding connection and is field repairable.

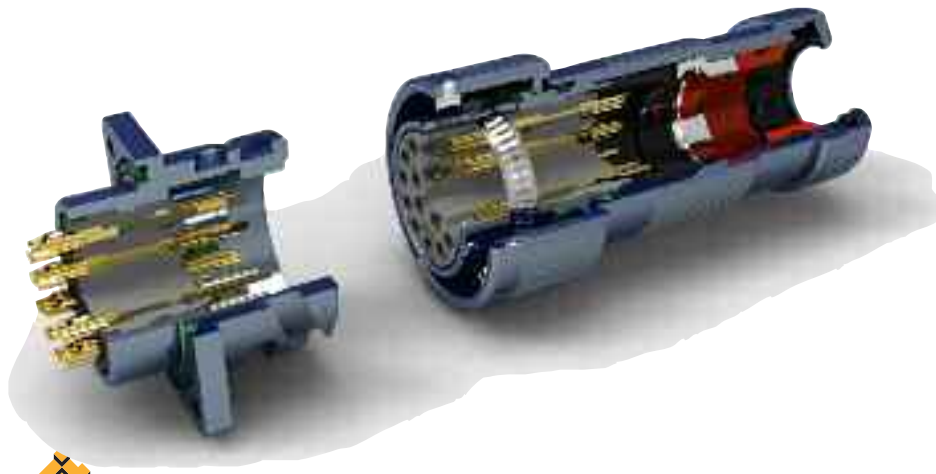

# Cannon VG/CA-Bayonet

## Technical Data

Contact rating at 68 °F (+20 °C)

Contact size	Max. current A
10	8
16S/15S	22
16/15	22
12/25	41
8/60/100	74
4/160	135
0/500	245

### Current rating

Depending on ambient temperature

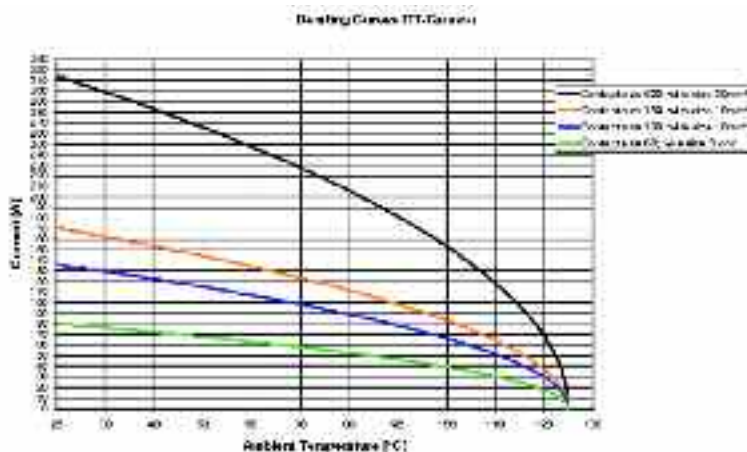
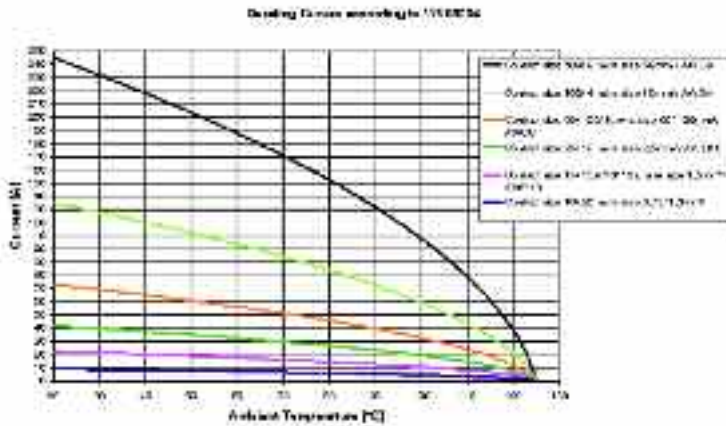

### Contact resistance (Millivolt test)

The contact resistance has to be tested according to VG95234 part 2, test no. 5.10.1 and VG 95210, part 37. The measuring points are indicated in the illustration.

Contact size	Max. contact resistance mΩ
Metric	AWG
10	–
15S/15	16S/16
25	12
60/100	8
160	4
500	0

### Insulation resistance

Acc. to VG95319, part 2, test no. 5.12 and VG95210, part 32, test condition B

Standard insulator material > 1000 MΩ  
FKM insulator material (upon request) > 5000 MΩ

### Test voltage

Acc. to VG95319, part 2, test no. 5.13 and VG 95210, part 31  
Test voltage for service rating:

Service rating	Test voltage $V_{rms}$
Instruments	1050
A	2000
B	4500
D	2500
E	3500

### Air and creepage paths (min.)

Voltage class	Instr.	A	D	E
Air and creepage paths mm	0,7	1,1	2,8	4,8

### Operating voltage and connector usage

Connectors in equipments must not be separated or mated under load when used per specifications.

As according to specification the connectors are suitable for an operating voltage of 50 V (see Product Safety Information). However, this is only valid, when the connectors are freely accessible during operation and consequently might be touchable. When the connectors will be operated with line voltage, please contact ITT Customer Service for an alternative connector solution.

Dimensions shown in mm

Specifications and dimensions subject to change

www.ittcannon.com



# Cannon VG/CA-Bayonet

## Mechanical Features

**Ambient temperature**  
Standard insulator material  
-55°/125°C (-67/257°F)

FKM insulator material\*  
-30°/200°C (-22/392°F)

**Safety provisions\*\***  
In mated condition  
General (All connectors):  
IP67 acc. to . DIN 40050

VG 95234 Connectors:  
1 bar for 16h

IP69k Version Connectors:  
Plug with Universal Endbell and receptacle with O- Ring  
IP68 (1bar for 16h); IP69k (Water jet sealed) acc. to DIN 40050

**Vibration test**  
200 m/s<sup>2</sup> at 10 to 2000 Hz

**Mating cycles**  
500 min.

**Withdrawl force per contact.**  
The corresponding separating force has to be measured according to VG95319, part 2, test no. 5.7. using the required test gage and DIN EN60512-16-5.

Contact size metric	AWG	Separating force min.	
		N	Gage
10	-	0,3	G 0,99
15S/15	16S/16	1,0	G 1,56
25	12	1,5	G 2,36
60/100	8	3,0	G 3,58
160	4	4,0	G 5,69
500	0	8,5	G 9,04

**Gage**  
(see also VG95234, Part 1)

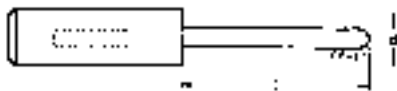

Gage	Contact diameter d +0,01	L -1
G 0,99	0,99	7
G 1,56	1,56	9
G 2,36	2,36	12
G 3,58	3,58	13
G 5,69	5,69	13
G 9,04	9,04	13

## Coupling torque

The allowable coupling torques have to be tested under full bundle conditions of the connectors to VG95319, part 2, test no. 5.8.2.

Shell size	Allowable coupling torque closing and opening	
	Nm max.	Opening Nm min.
10SL	1,7	0,15
12S	2,5	0,23
14S	3,6	0,35
16S/16	5,5	0,46
18	8	0,58
20	9	0,7
22	11	0,8
24	14	0,8
28	17	0,92
32	19	1,03
36	23	1,03

## Contact retention

The contact retention has to be tested according to VG95319, part 2, test no. 5.4. Test force direction = Mating direction.

Contact size	AWG	Test force N
10	-	30
15S/15	16S/16	35
25	12	55
60/100	8	80
160	4	90
500	0	95

## Materials

**Shell**  
Standard finish Aluminum alloy  
Olive drab chromate coating over  
cadmium plating

Alternative finish Zinc cobalt (see page 12 –  
Modification)

**Insulator  
and grommets** Polychloroprene (Standard)  
FKM (High temperature)\*

**Contacts**  
Standard finish Copper alloy  
Hard silver  
Special finish A176 nickel and hard gold plating

\* upon request

\*\* **Longitudinal sealing:** The connector is not sealed against fluids entering through the cable, as the sealing lips of the single wire sealing are pressing against the jacket of the individual conductors.



# Cannon VG/CA-Bayonet

## Mounting Holes

Mounting holes for wall mounting receptacles style A, B1, B2, C1, C2, J1, J2, N1 and N2 acc. to VG95234, or CA 3100E/F/R-B and CA 3102 E-B.

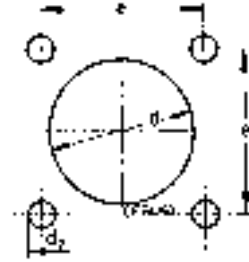

Shell size	ø d1H12 Style A CA 3102E-B	Style B1, B2 C1, C2, J1, J2 N1, N2 CA 3100E, F, R-B TBF-B/-05	ø d2H13 Style A, B2, C2, J2, N2 CA-B Mod-05	Style B1, C1, J1, N1  CA 3100E, F, R-B	e ±0,15	screws to be used A, B2, C2, J2, N2  CA-B-Mod. 05	B1, C1, J1, N CA 3100E, F
10SL	16,4	18,5	3,4	4,5	18,2	M3...DIN 85	M4...DIN 84
12S	16,4	21,7	3,4	4,5	20,6	M3...DIN 85	M4...DIN 84
14S	19,7	24,9	3,4	4,5	23,0	M3...DIN 85	M4...DIN 84
16S	22,9	27,7	3,4	4,5	24,6	M3...DIN 85	M4...DIN 84
16	22,9	27,7	3,4	4,5	24,6	M3...DIN 85	M4...DIN 84
18	26,1	31,1	3,4	4,5	27,0	M3...DIN 85	M4...DIN 84
20	29,5	34,5	3,4	4,5	29,4	M3...DIN 85	M4...DIN 84
22	32,7	37,8	3,4	4,5	31,8	M3...DIN 85	M4...DIN 84
24	36,0	41,3	3,9	4,5	34,9	M3,5...DIN 85	M4...DIN 84
28	42,0	47,1	3,9	5,5	39,7	M3,5...DIN 85	M5...DIN 84
32	48,3	53,8	4,5	5,5	44,5	M4...DIN 85	M5...DIN 84
36	54,6	60,0	4,5	5,5	49,2	M4...DIN 85	M5...DIN 84

\* When used with safety elements the max. outer diameter must not exceed the outer diameter of the screw head.

## Harnessing

VG95234 connectors are designed for single wire harnessing. Full sealing will be guaranteed only by using wires in accordance with MIL-W-5086, LN 9251 (for AWG) and TL 6145-009 and TL 6145-011 (for metric wires). All other wires have to conform to wire and insulation diameters with the data given in the following table:

Contact size AWG	metric mm	Crimp- and solder contacts AWG	metric mm <sup>2</sup>	Insulation Ø AWG	metric mm
-	10	-	0,75-1,0	-	1,45-2,5
16S/15S	16/15	16	0,75-1,5	1,6-2,8	1,60-2,8
12	25	12	2,5	2,9-3,5	2,9-3,5
-	60	-	6,0	-	3,5-4,9
8	100	8	10,0	4,2-5,8	5,5-6,5
4	160	4	16,0	6,2-9,0	7,1-9,0
0	500	0	50,0	10,5-13,0	10,5-13,0

## Wire Stripping

Either mechanical or hot stripping can be used. Prevent conductor or insulator damage. For solder contacts, conductors have to be pretinned.

Note: Do not twist conductors used with crimp contacts. Do not touch uninsulated conductors before crimping. Twisting of conductors and grease or lubricants on the wires cause poor crimp quality.

Contact size AWG	metric	Stripping length mm
-	10	4,0 + 0,4
16S/15S	16/15	6,0 + 0,5
12	25	6,0 + 0,5
8	60/100	11,0 + 0,8 - 0,4
4	160	11,0 + 0,8 - 0,4
0	500	13,0 + 0,8 - 0,4

# Cannon VG/CA-Bayonet

## Separating and Mounting Dimensions

When using connectors according to VG95234 the below mentioned installation dimensions have to be met.

Connector style D  
or  
CA3106E-B and  
CA3106F-B  
CA3106F-B-13/-14/-15

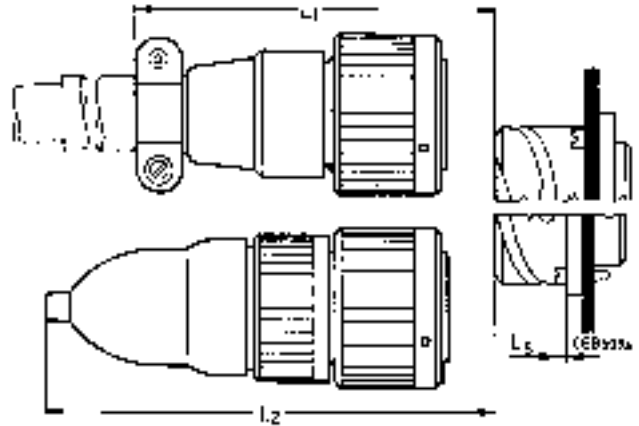

Connector style G, M, R1  
or  
CA3106E-B-02/-03/-06  
CA3106E-B-13/-14/-15 and  
CA3106E-B-32  
with shrink boot, straight,  
acc. VG95343

Connector style E, E1 and K  
or  
CA3108E/F-B and  
CA3108F-B-13/-14/-15

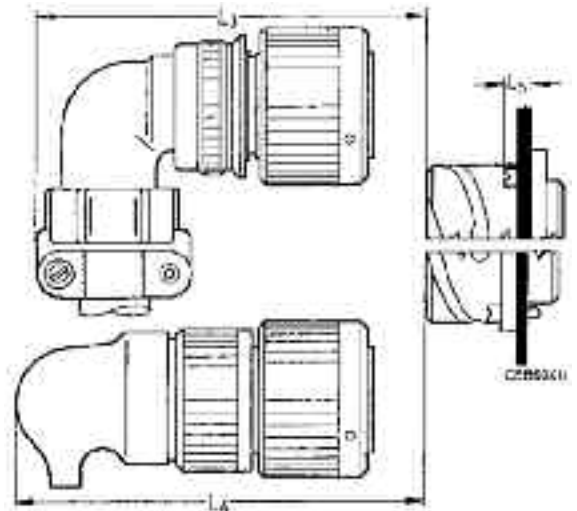

Connector style G, M, R1  
or  
CA3106E-B-02/-03/-06  
CA3106E-B-32  
with shrink boot 90°  
acc. to VG 95343

Shell Size	L1 (D) min.	L2 (G/M) min.	L3 min.	L4		L5 max.	L6 max.
				(G/M) min.	R1 + 10 mm		
10SL	70	70	70	65	75	8,0	3,5
12S	70	75	75	70	80	8,0	3,5
14S	70	75	75	70	80	8,0	3,5
16S	70	90	80	80	90	8,0	3,5
16	80	100	90	90	100	6,5	3,5
18	90	100	90	90	100	8,0	3,5
20	90	100	95	100	110	8,0	3,5
22	90	100	95	100	110	8,0	3,5
24	110	120	105	110	120	8,0	5,0
28	110	120	105	110	120	9,0	5,0
32	110	180	115	120	130	9,0	6,0
36	110	190	120	130	140	9,0	6,0

# Cannon VG/CA-Bayonet

## How to order

VG Order reference

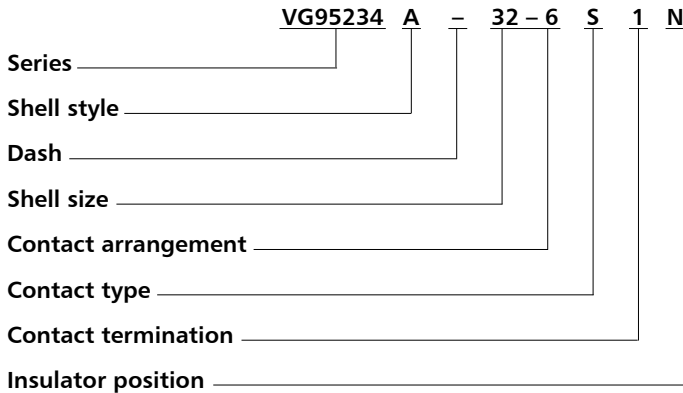

## Explanation

Series	VG95234
Shell style	J1, J2, N1, N2, S1, U1, U2 – wall mounting receptacle F – cable connection plug A, B1, B2 – box mounting receptacle C1, C2 – bulkhead receptacle D, G, H, L, M, R1, T – straight plug E, E1, K – plug 90°
Shell size	10SL, 14S, 16S, 16, 18, 20, 22, 24, 28, 32 and 36
Contact arrangement	see page 13
Contact type	P – Pin contact S – Socket contact
Contact termination	without identification – contacts for metric wire sizes identification 1* – contact for AWG wire sizes
Insulator position	see page 31

## Accessories acc. to VG

Dummy receptacles	VG95234 BOD
Gaskets, front mount	VG95234 DA
Gaskets, rear mount	VG95234 DH
Protecting caps	VG95234 KR
Protecting caps	VG95234 KB
Cabel caps	VG95234 KK
Bushing	VG95234 KT

\* Only valid for layout within the VG95234.

Layout list permitting identification 1:

Layout	Page Number
22-2	18
24-9	19
24-11	19
24-12	20
28-22	22
32-1	22
32-6	23
36-3	24
36-5	24
36-6	24

## How to order

Cannon Order reference

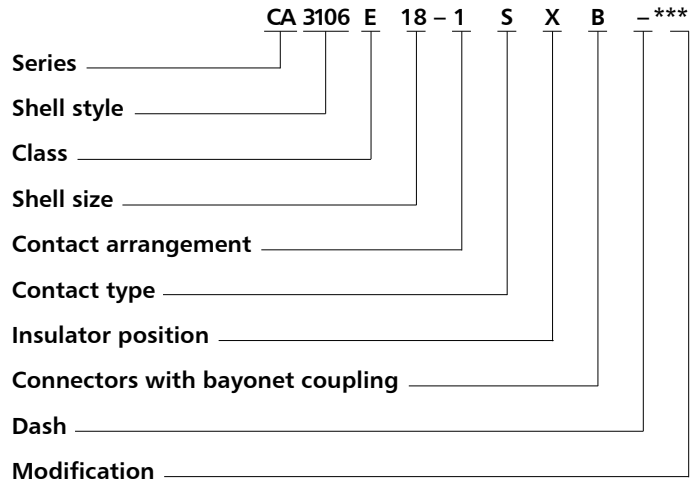

## Explanation

Series	CA – Circular connectors with bayonet coupling
Shell style	3100 – Wall mounting receptacle 3101 – Cable connecting plug 3102 – Box mounting receptacle 3105 – Dummy receptacle for front and panel mounting 3106 – Plug, straight 3108 – Plug, 90° TBF – Bulkhead receptacle
Class	E – environmental with resilient insulators and endbell with clamp and bushing F – environmental with resilient insulator and endbell for flex tube R – environmental with resilient insulator and shortened light-weight endbell without cable clamp PG – PG gland adaptor environmental ME – Metric gland adaptor environmental*
Shell size	10SL, 12S, 14S, 16S, 16, 18, 20, 22, 24, 28, 32 and 36
Contact arrangement	see page 13
Contact type	P – Pin S – Socket PS – one side pin, one side socket (only for TBF)
Insulator position	Besides the normal position further insulator positions are possible for Cannon connectors (see page 31) to prevent mismatching. Polarization is achieved by turning the pin contact insulator clockwise towards the shell, the socket insulator, however, in opposite clockwise direction. This information refers to the mating side of the contact insulator. For special insert alternations of standard inserts see page 28.
Modification	see next page

# Cannon VG/CA-Bayonet

<b>Modification</b>	01	– metric crimp contacts
(only for CA.....-B)	02	– adapter for heat shrink boots AWG crimp contacts, CA3102
	03	– adapter for heat shrink boots, metric contacts
	04	– rear mount, thread in flange, metric crimp contacts
	05	– rear mount, through holes in flange, (CA3100, CA 3102, rear mounting CA 20, TBF)
	06	– shrink boot adapter, solder pot contacts
	08	– angular endbell, through holes in flange (for CA3100 only)
	09	– angular endbell, through holes in flange (for CA3100 only)
	13	– shielded version, solder contacts
	14	– shielded version, metric crimp con- tacts
	15	– shielded version, AWG crimp contacts
	32	– shielded endbell, reduced cable entry diameter
	41	– shielded version, grounding spring on barrel
	109	– F80 contacts, rear mount, thread holes in flange (for CA3102 only)
	111	– rear mount, thread holes (CA3102 only), solder contacts
	F80	– AWG crimp contacts
	A176	– gold plated contact, see pages 58-59
	A232	– Zinc cobalt black plating
	A233	– Zinc cobalt green plating
	A240	– Zinc Nickel plating, blue iridescent
	F42	– less grommet and backshell
	F0	– less contacts, contacts to be ordered separately, see pages 58-61

## Important!

When connectors are requested according to VG95234 modification, e.g. with another finish, with other contact arrangements and solder contacts, they are to be ordered only with the ITT Cannon order reference.

Connectors acc. to VG95234 are generally available with insert positions X and Y only.

VG order reference with modification is not possible.

## With Spring Washer and Friction Ring

These connectors feature a spring washer and a friction ring under the coupling nut.

Advantage	Vibrations are being compensated
Ordering example	according performance class insert „W“ after Class E, F or R
CA06EW	– connector with spring washer, endbell with cable and bushing
CA06FW	– connector with spring washer, endbell for flex tube
CA06RW	– connector with spring washer and short endbell
CA08EW/FW	– connector with spring washer and 90° endbell

The connectors acc. to **VG95234** are generally delivered with **spring washer**.

## Other Shell Styles

CA3100E-B-02/03/06	– adapter for heat shrink boot
CA3100F-B-08/09	– 90° endbell for flex tube
CA3100E-B-08/09	– 90° endbell, cable clamp and bushing
CA3100F-B-08/09	– 90° endbell flex tube
CA02L-B	– receptacle with pcb solder contacts
CA20L-B	– rear mount receptacle with pcb solder contacts
CA06EH	– H stands for FKM insulator and sealing material. FKM is a high temperature material good for up to 200°C/392°F plus an extraordinary performance against oils of the various nature. (The full range of end bell styles can be utilized).
CA07A-B	– jam nut receptacle
CA00EP-B-TL	– TINEL-LOCK adapter, contact factory
CA06EW-B-TLXX	– TINEL-LOCK adapter, contact factory

















# Cannon VG/CA-Bayonet

## Contact Arrangements

View on Mating face of Pin Insulator	No. of Contacts	Contact arrangement		Service rating	Insulator position						Position	Special polarization	Insulator weight (g) including contacts	
		Contact size VG	CA		N	V	W	X	Y	Z			pin	socket
	3	10SL-3 15S	10SL-3 16S	A	0	-	-	-	-	-	-	-	6	9
	2	10SL-4 15S	10SL-4 16S	A	0	-	-	-	-	-	-	-	4	6
♦	2	-	12S-3 16S	A	0	100	70	145	215	290	-	-	4	6
	1	-	12S-4 16S	D	0	-	-	-	-	-	-	-	3	4,5
	4	-	12SA10 16S	Instr.	0	-	-	-	-	-	3 8	110 250	6	8
	3	-	14S-1 16S	A	0	-	-	-	-	-	-	-	6	9
	4	-	14S-2 16S	Instr.	0	-	-	120	240	-	-	-	7	11
	1	-	14S-4 16S	D	0	-	-	-	-	-	-	-	4	7
	5	-	14S-5 16S	Instr.	0	-	-	110	-	-	-	-	9	13
	6	14S-6 15S	14S-6 16S	Instr.	0	-	-	-	-	-	-	-	11	15
♦	3	-	14S-7 16S	A	0	-	90	180	270	-	-	-	6	9
	2	-	14S-9 16S	Instr.	0	-	70	145	215	290	-	-	5	18
	7	-	14SA7 16S	Instr.	0	-	-	-	-	-	-	-	10	15
♦	7	16S-1 15S	16S-1 16S	A	0	-	80	-	-	280	-	-	14	19
	2	16S-4 15S	16S-4 16S	D	0	-	35	110	250	325	-	-	7	10
♦	3	-	16S-5 16S	A	0	-	70	145	215	290	-	-	8	12
	5	-	16S-8 16S	A	0	-	-	170	265	-	-	-	10	15

♦ Attention: for all alternate positions of these contact arrangements a tendency to overmate can be stated. It is within the customer's responsibility to use these insert positions.















# Cannon VG/CA-Bayonet

View on Mating face of Pin Insulator	No. of Contacts	Contact arrangement		Service rating	Insulator position						Position	Special polarization	Insulator weight (g) including contacts socket	
		Contact size VG	CA		N	V	W	X	Y	Z				
	3 2 1	16-7 15 100	16-7 16 8	A	0	-	80	110	250	280	-	-	16	25
	4 2 2	-	16-9 12 16	A	0	-	35	110	250	325	-	-	13	20
◆ 	3	16-10 25	16-10 12	A	0	-	90	180	270	-	-	-	17	24
	2	-	16-11 12	A	0	-	35	110	250	325	-	-	11	17
	1	16-12 160	16-12 4	A	0	-	-	-	-	-	-	-	24	28
	2	16A11 25 (socket) 25A (pin) short	16A11 12	A	0	-	35	110	250	325	-	-	11	17
◆ 	10	18-1 15	18-1 16	A (B, C, F, G) Instr. (all others)	0	-	70	145	215*	290	-	-	24	37
	2	-	18-3 12	D	0	-	35	110	250	325	-	-	13	22
	4	-	18-4 16	D	0	-	35	110	250	325	-	-	19	30
	3 2 1	-	18-5 12 16	D	0	-	80	110	250	280	-	-	15	25
	1	-	18-6 4	D	0	-	-	-	-	-	-	-	24	32
	1	-	18-7 8	D	0	-	-	-	-	-	-	-	16	25
	8 1 7	-	18-8 12 16	A	0	-	70	-	-	290	-	-	18	30
	7 2 5	8-9 25 5	18-9 12 16	Instr.	0	-	80	110	250	280	-	-	18	30
	4	-	18-10 12	A	0	-	-	120	240	-	-	-	13	22
	5	18-11 25	18-11 12	A	0	-	-	170	265	-	-	-	31	40

\*No good coding; mates with "0" positive easily.











◆ Attention: for all alternate positions of these contact arrangements a tendency to overmate can be stated. It is within the customer's responsibility to use these insert positions.

# Cannon VG/CA-Bayonet

View on Mating face of Pin Insulator	No. of Contacts	Contact arrangement		Service rating	Insulator position						Position	Special polarization	Insulator weight (g) including contacts	
		Contact size VG	CA		N	V	W	X	Y	Z			pin	socket
	6	-	18-12 16	A	0	-	80	-	-	280	-	-	15	25
◆ 	4 1 3	18-13 60 25	18-13 8 12	A	0	-	80	110	250	280	-	-	15	24
	7 2 5	-	18-17 12 16	Instr.	0	-	-	-	-	-	12	100	15	23
	10	-	18-19 16	A	0	-	-	120	240	-	-	-	19	31
	5	-	18-20 16	A	0	-	90	180	270	-	-	-	15	25
	3	-	18-21 12	A	0	-	-	-	-	-	-	-	17	28
	3	-	18-22 16	D	0	-	70	145	215	290	-	-	10	20
	1	20-2 500	20-2 0	D	0	-	-	-	-	-	-	-	46	55
	3	-	20-3 12	D	0	-	70	145	215	290	-	-	28	42
	4	-	20-4 12	D	0	-	45	110	250	-	-	250 (20A37)	24	40
	3	-	20-6 16	D	0	-	-	-	-	-	-	-	22	36
	8	-	20-7 16	A (C, D, E, F) D (A, B, H, G)	0	-	80	110	250	280	-	-	28	42
	6 2 4	20-8 100 15	20-8 8 16	Instr.	0	-	80	110	250	280	-	-	37	49
	13	-	20-11 16	Instr.	0	-	-	-	-	-	-	-	25	41

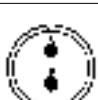
◆ Attention: for all alternate positions of these contact arrangements a tendency to overmate can be stated. It is within the customer's responsibility to use these insert positions.

# Cannon VG/CA-Bayonet

View on Mating face of Pin Insulator	No. of Contacts	Contact arrangement		Service rating	Insulator position						Position	Special polarization	Insulator weight (g) including contacts	
		Contact size VG	CA		N	V	W	X	Y	Z			pin	socket
	5 3 2	-	20-14 12 8	A	0	-	80	110	250	280	-	-	22	39
	7	-	20-15 12	A	0	-	80	-	-	280	-	-	27	46
	9 2 7	-	20-16 12 16	A	0	-	80	110	250	280	-	-	19	32
	6 5 1	-	20-17 12 16	A	0	-	90	180	270	-	-	-	20	33
	9 3 6	-	20-18 12 16	A	-	-	35	110	250	325	-	-	19	32
	3	-	20-19 8	A	0	-	90	180	270	-	-	-	33	46
	6 3 3	-	20-22 8 16	A	-	-	80	110	250	280	-	-	37	49
	2	-	20-23 8	A	-	-	35	110	250	325	-	-	25	35
	4 2 2	-	20-24 8 16	A	0	-	35	110	250	325	-	-	40	53
	14	-	20-27 16	A	0	-	35	110	250	325	-	-	26	42
	17	-	20-29 16	A	0	-	80	-	-	280	-	-	29	47

◆ Attention: for all alternate positions of these contact arrangements a tendency to overmate can be stated. It is within the customer's responsibility to use these insert positions.













# Cannon VG/CA-Bayonet

View on Mating face of Pin Insulator	No. of Contacts	Contact arrangement		Service rating	Insulator position						Position	Special polarization	Insulator weight (g) including contacts	
		Contact size VG	CA		N	V	W	X	Y	Z			pin	socket
	11	–	20-33 16	A	0	–	–	–	–	2 3 17	260 110 130	–	23	38
	9	20A9 25	20A9 12	D (J) Instr. (all others)	0	–	–	110	250	–	–	–	21	35
	19	20A48 15	20A48 16	Instr.	0	–	–	80	280	–	–	–	30	50
	2	–	22-1 8	D	0	–	35	110	250	325	–	–	28	42
	3	22-2 8	22-2 8	D	0	–	70	145	215	290	–	–	35	50
	4 2 2	–	22-4 8 12	A	–	–	35	110	250	325	–	–	34	48
	6 2 4	–	22-5 12 16	D	–	–	35	110	250	325	–	–	23	38
	1	–	22-7 0	E	0	–	–	–	–	–	–	–	45	57
	2	–	22-8 12	E	–	–	35	110	250	325	–	–	18	28
	3	–	22-9 12	E	0	–	70	145	215	290	–	–	21	32

◆ Attention: for all alternate positions of these contact arrangements a tendency to overmate can be stated. It is within the customer's responsibility to use these insert positions.

# Cannon VG/CA-Bayonet

View on Mating face of Pin Insulator	No. of Contacts	Contact arrangement		Service rating	Insulator position						Position	Special polarization	Insulator weight (g) including contacts pin socket	
		Contact size VG	CA		N	V	W	X	Y	Z				
	4	–	22-10 16	E	–	–	35	110	250	325	–	–	17	31
	5 2 3	22-12 100 15	22-12 8 16	D	0	–	80	110	250	280	–	–	28	42
	19	22-14 15	22-14 16	A	0	–	80	–	–	280	–	–	30	50
	6 5 1	–	22-15 12 16	A (A, B, C, E, F) E (D)	0	–	80	110	250	280	–	–	30	50
	9 3 6	–	22-16 12 16	A	0	–	80	110	250	280	–	–	28	45
	14	–	22-19 16	A	0	–	80	110	250	280	–	–	28	47
	9	–	22-20 16	A	0	–	35	110	250	325	–	–	22	39
	3 2 1	–	22-21 16 0	A	0	–	80	110	250	280	–	–	49	58
	4	22-22 100	22-22 8	A	0	–	–	110	250	–	–	–	42	58
	8	–	22-23 12	D (H) A (all others)	0	–	35	–	250	–	–	–	34	54
	9 1 8	22-27 60 15	22-27 8 16	A (A to H) D (J)	0	–	80	–	250	280	–	–	21	34











◆ Attention: for all alternate positions of these contact arrangements a tendency to overmate can be stated. It is within the customer's responsibility to use these insert positions.

# Cannon VG/CA-Bayonet

View on Mating face of Pin Insulator	No. of Contacts	Contact arrangement		Service rating	Insulator position						Position	Special polarization	Insulator weight (g) including contacts	
		Contact size VG	CA		N	V	W	X	Y	Z			pin	socket
	7	-	22-28 12	A	-	-	80	-	-	280	-	-	33	50
	4	22B22 60	-	A	0	-	-	110	250	-	-	-	42	58
	7	-	24-2 12	D	0	-	80	-	-	280	-	-	33	53
	4 1 3	-	24-4 0 16	D	-	-	80	110	250	280	-	-	51	63
	16	-	24-5 16	A	-	-	80	110	250	280	-	-	30	54
	8 8	-	24-6 12	A (B,C,D,E,F)	0	-	80	110	250	280	-	-	32	41
	16 2 14	-	24-7 12 16	A	0	-	80	110	250	280	-	-	45	65
	2	24-9 4	24-9 4	A	0	-	35	110	250	325	-	-	45	60
	7	24-10 100	24-10 8	A	0	-	80	-	-	280	-	-	65	85
	9 3 6	24-11 100/8 25/12	24-11 8 12	A	0	-	35	110	250	325	-	-	55	75

◆ Attention: for all alternate positions of these contact arrangements a tendency to overmate can be stated. It is within the customer's responsibility to use these insert positions.

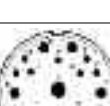
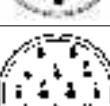
# Cannon VG/CA-Bayonet







View on Mating face of Pin Insulator	No. of Contacts	Contact arrangement		Service rating	Insulator position						Position	Special polarization	Insulator weight (g) including contacts	
		Contact size VG	CA		N	V	W	X	Y	Z			pin	socket
	5 2 3	24-12 4 12	24-12 4 12	A	0	-	80	110	250	280	-	-	60	80
	12	-	24-19 16	A	0	-	-	-	-	-	-	-	28	47
	11 2 9	-	24-20 12 16	D	0	-	80	110	250	280	-	-	40	60
	4	-	24-22 8	D	0	-	45	110	250	-	-	-	44	61
	7	-	24-27 16	E	-	-	80	-	-	280	-	-	21	37
	24	24-28 15	24-28 16	Instr.	0	-	80	110	250	280	-	-	40	65
	12	-	24A24 12	A	-	-	-	-	-	-	2 4 9 12	260 80 280 100	46	71
	28	-	24A28 16	Instr.	-	-	65	146	235	-	-	-	42	75
	19 13 5 1	-	24A51 16 12 8	A	-	-	-	-	-	-	14	30	60	70
	14 12 2	-	28-2 16 12	D	-	-	35	110	250	325	-	-	43	61
	5 2 2 1	-	28-5 4 16 12	D	-	-	35	110	250	325	-	-	60	70

◆ Attention: for all alternate positions of these contact arrangements a tendency to overmate can be stated. It is within the customer's responsibility to use these insert positions.



Dimensions shown in mm  
Specifications and dimensions subject to change

# Cannon VG/CA-Bayonet

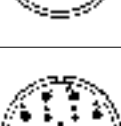
View on Mating face of Pin Insulator	No. of Contacts	Contact arrangement		Service rating	Insulator position						Position	Special polarization	Insulator weight (g) including contacts socket	
		Contact size VG	CA		N	V	W	X	Y	Z				
	12 6 6	-	28-9 16 12	D	-	-	80	110	250	280	-	-	46	65
	7 2 2 3	-	28-10 4 8 12	A (= A, B, C, D, E, F) D (= G)	-	-	80	110	250	280	-	-	80	91
	22 4 18	28-11 25 15	28-11 12 16	A	0	-	80	110	250	280	-	-	65	110
	26	-	28-12 16	A	0	-	90	180	270	-	-	-	47	77
	35	-	28-15 16	A	0	-	80	110	250	280	-	-	54	90
	20	-	28-16 16	A (A-L) D (M, N, P) B (R)	0	-	80	110	250	280	-	-	41	68
	10 6 4	-	28-19 16 12	A (= C, E, G, J, K, L) D = A, B B = H, M	-	-	80	110	250	280	-	-	40	58
	14 10 4	28-20 25 15	28-20 12 16	A	0	-	80	110	250	280	-	-	65	110







◆ Attention: for all alternate positions of these contact arrangements a tendency to overmate can be stated. It is within the customer's responsibility to use these insert positions.

# Cannon VG/CA-Bayonet

View on Mating face of Pin Insulator	No. of Contacts	Contact arrangement		Service rating	Insulator position						Position	Special polarization	Insulator weight (g) including contacts		
		Contact size VG	CA		N	V	W	X	Y	Z			pin	socket	
	37	28-21 15	28-21 16	A	0	-	80	110	250	280	-	-	58	93	
	6	28-22 160/4 15/16	28-22 4 16	D	0	-	70	145	215	290	-	-	80	120	
All alternating insert position as above are permitted for VG95234 types.															
	12	-	28-51 12	D	-	-	80	135	195	-	-	-	57	77	
	9	4 5	28A16 4 16	A (e) Instr. (all others)	0	-	-	-	-	-	2 3 8 9	260 110 250 280	100	135	
	43	-	28A51 16	A	0	-	-	-	-	-	3 4 8 9 12	110 80 250 280 100	64	107	
	28	9 19	28A63 25 15	28A63 12 16	A	0	-	-	100	260	-	-	85	135	
	5	2 3	32-1 500/0 25/12	32-1 0 12	E (A) D (all others)	0	-	80	110	250	280	-	-	130	155
	2		32-5 0	D	0	-	35	110	250	325	-	-	86	114	

◆ Attention: for all alternate positions of these contact arrangements a tendency to overmate can be stated. It is within the customer's responsibility to use these insert positions.

# Cannon VG/CA-Bayonet

View on Mating face of Pin Insulator	No. of Contacts	Contact arrangement		Service rating	Insulator position						Position	Special polarization	Insulator weight	
		Contact size VG	CA		N	V	W	X	Y	Z			(g) including contacts pin	socket
	23 2 3 2 16	32-6 160/4 60/8 25/12 15/16	32-6 4 8 12 16	A	0	-	80	110	250	280	-	-	130	170
	35 7 28	32-7 25 15	32-7 12 16	Instr. (A, B, U, I.) A (all others)	0	-	80	125	235	280	-	-	110	160
	30 6 24	-	32-8 12 16	A	0	-	80	125	235	280	-	-	105	155
	14 12 2	-	32-9 16 4	D	0	-	80	110	250	280	-	-	79	130
	23 5 18	-	32-13 12 16	D	0	-	80	110	250	280	-	-	95	145
	8 2 6	-	32-15 0 12	D	0	-	35	110	250	325	-	-	140	165
	4	-	32-17 4	D	0	-	45	110	250	-	-	-	80	116

◆ Attention: for all alternate positions of these contact arrangements a tendency to overmate can be stated. It is within the customer's responsibility to use these insert positions.





# Cannon VG/CA-Bayonet

View on Mating face of Pin Insulator	No. of Contacts	Contact arrangement		Service rating	Insulator position						Position	Special polarization	Insulator weight (g) including contacts pin socket	
		Contact size VG	CA		N	V	W	X	Y	Z				
	54	-	<b>32A10</b> 16	A	-	-	-	-	-	-	2 3 4 8 9 12	260 110 80 250 280 100	89	132
	47	-	<b>32A47</b> 16	A	-	-	-	-	-	-	2 3 4 8 9 12	260 110 80 250 280 100	73	120
	55		<b>32A55</b> 16	A	-	-	80	110	250	280	-	-	90	134
	61 20 41	<b>32A69</b> 15 10	<b>32A69</b> 16 20	Instr.	0	-	-	110	250	-	-	-	49	84
														Not for through-bulkhead receptacle C1 / C2.
	6 3 3	<b>36-3</b> 500/0 25/12	<b>36-3</b> 0 12	D	0	-	70	145	215	290	-	-	165	200
														All alternating insert position as above are permitted for VG95234 type.
	4	<b>36-5</b> 500/0	<b>36-5</b> 0	A	0	-	-	120	240	-	-	-	152	181
	6 4 2	<b>36-6</b> 4 0	<b>36-6</b> 4 0	A	0	-	35	110	250	325	-	-	155	173

◆ Attention: for all alternate positions of these contact arrangements a tendency to overmate can be stated. It is within the customer's responsibility to use these insert positions.



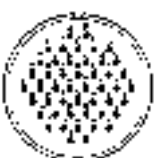

# Cannon VG/CA-Bayonet

View on Mating face of Pin Insulator	No. of Contacts	Contact arrangement		Service rating	Insulator position						Position	Special polarization	Insulator weight (g) including contacts	
		Contact size VG	CA		N	V	W	X	Y	Z			pin	socket
	47 7 40	-	36-7 12 16	A	-	-	80	110	250	280	-	-	92	144
	47 1 46	-	36-8 12 16	A	-	-	80	110	250	280	-	-	80	132
	31 14 14 2 1	-	36-9 16 12 8 4	A	0	-	80	125	235	280	-	-	116	159
	48	36-10 15	36-10 16	A	0	-	80	125	235	280	-	-	79	133
	16 5 5 6	-	36-14 8 12 16	D	0	-	-	-	-	-	-	-	150	230
	35	-	36-15 16	D (m) A (all others)	0	-	60	125	245	305	-	-	70	111

◆ Attention: for all alternate positions of these contact arrangements a tendency to overmate can be stated. It is within the customer's responsibility to use these insert positions.

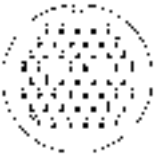
# Cannon VG/CA-Bayonet

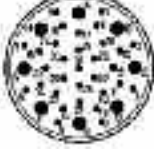
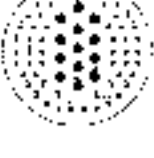
View on Mating face of Pin Insulator	No. of Contacts	Contact arrangement		Service rating	Insulator position						Position	Special polarization	Insulator weight (g) including contacts pin socket	
		Contact size VG	CA		N	V	W	X	Y	Z				
	52	-	36A34 16	A	-	-	-	-	-	-	2 3 4 8 9 12 20	260 110 80 250 280 100 220	83	139
	8 4 4	-	36A35 16 0	A	-	-	-	-	-	-	2 3 8 9	260 110 250 280	172	183
	27	-	36A46 12	A	-	-	-	-	-	-	2 3 4 8 9 12	260 110 80 250 280 100	112	154
	39 8 31	-	36A98 8 16	A	0	-	-	110	-	-	-	-	160	140
	65 15 50	-	36A99 16 20*	Instr.	-	-	30	135	-	-	-	-	80	121

\* reduced contact termination 0,3 mm<sup>2</sup>

◆ Attention: for all alternate positions of these contact arrangements a tendency to overmate can be stated. It is within the customer's responsibility to use these insert positions.

# Cannon VG/CA-Bayonet

## Alternate Insert Positions

Indicates location of centerline of key or keyway of shells in fixed normal position. Insert is rotated as shown by arrow and letters.

Connectors according to VG95234 are generally available with insert positions X and Y only.

Tolerances:

# 10SL-20:  $\pm 2^\circ$

# 22-36:  $\pm 1,5^\circ$

# 32A69:  $\pm 1^\circ$

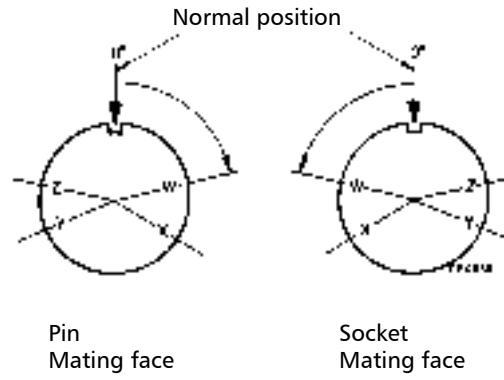

# Cannon VG/CA-Bayonet

## Special Insert Alternations

Special insert alternations are marked by positions. The position number indicates the turning of the contact insert in the direction of the polarizing key in view of the mating or termination side of the socket insulator.

Contact arrangement	Position of	Contact arrangement	Polarization
12SA10	3	12SA10	110°
	8	12SA10	250°
18-17	12	18-9	100°
24A24	2	24A24	260°
	4	24A24	80°
	9	24A24	280°
	12	24A24	100°
32-16	12	32-6	100°

Position	Polarization
2	260°
3	110°
4	80°
5	use pos. 3
6	85°
8	250°
9	280°
11	105°
12	100°
13	use pos. 8
14	30°
15	45°
16	120°
17	130°
18	150°
19	195°
20	220°
21	255°
22	290°
23	165°
24	330°
25	235°
26	125°

### Positions

View shows mating side of pin or termination side of socket.



Insert positions are added without hyphen directly behind the contact type.

Example:

CA3106F32A10P[2]-B-01

# Cannon VG/CA-Bayonet

## Contact Arrangements

Contact arrangement	No. of contacts	Contact size					
		0 500	4 160	8 100 60	12 25	16 15	20 10
12S4	1					1	
14S4	1					1	
16-12	1		1				
18-6	1		1				
18-7	1			1			
20-2	1	1					
22-7	1	1					
10SL4	2					2	
14S9	2					2	
16S4	2					2	
16-11	2				2		
16A11	2				2		
18-3	2				2		
20-23	2			2			
22-1	2			2			
22-8	2				2		
24-9	2		2				
32-5	2	2					
10SL3	3					3	
14S1	3					3	
14S7	3					3	
16S5	3					3	
16-7	3			1		2	
16-10	3				3		
18-5	3				2	1	
18-21	3				3		
18-22	3					3	
20-6	3					3	
20-19	3			3			
22-2	3			3			
22-9	3			3			
22-21	3	1				2	
12SA10	4					4	
14S2	4					4	
16-9	4				2	2	
18-4	4					4	
18-10	4				4		
18-13	4			1	3		
20-4	4				4		
20-24	4			2		2	
22-4	4			2	2		
22-10	4					4	
22-22	4			4			
22B22	4			4			
24-4	4	1				3	
24-22	4			4			
32-17	4		4				
36-5	4	4					

Contact arrangement	No. of contacts	Contact size					
		0 500	4 160	8 100 60	12 25	16 15	20 10
14S5	5					5	
16S8	5					5	
18-11	5				5		
18-20	5					5	
22-12	5			2		3	
24-12	5		2		3		
28-5	5		2		1	2	
32-1	5	2			3		
14S6	6					6	
18-12	6					6	
20-8	6			2		4	
20-22	6			3		3	
22-5	6				2	4	
22-15	6				5	1	
28-22	6		3			3	
36-3	6	3			3		
36-6	6	2	4				
14SA7	7					7	
16S1	7					7	
18-9	7				2	5	
18-17	7				2	5	
20-15	7					7	
22-28	7					7	
24-2	7					7	
24-10	7			7			
24-27	7					7	
28-10	7		2	2	3		
18-8	8				1	7	
20-7	8					8	
22-23	8					8	
32-15	8	2			6		
36A35	8	4				4	
24-6	8				8		
20-16	9				2	7	
20-18	9				3	6	
20A9	9					9	
22-16	9				3	6	
22-20	9					9	
22-27	9			1		8	
24-11	9			3	6		
28A16	9		4			5	
18-1	10					10	
18-19	10					10	
28-19	10				4	6	
20-33	11					11	
24-20	11				2	9	

Dimensions shown in mm  
Specifications and dimensions subject to change

# Cannon VG/CA-Bayonet

## Contact Arrangements

Contact arrangement	No. of contacts	Contact size					
		0 500	4 160	8 100 60	12 25	16 15	20 10
24-19	12					12	
24A24	12				12		
28-9	12				6	6	
28-51	12				12		
20-11	13					13	
20-27	14					14	
22-19	14					14	
28-2	14				2	12	
28-20	14				10	4	
32-9	14	2				12	
24-5	16					16	
24-7	16				2	14	
36-14	16			5	5	6	
20-29	17					17	
20A48	19					19	
22-14	19					19	
28-16	20					20	
28-11	22				4	18	
32-6	23		2	3	2	16	
32-13	23				5	18	
24-28	24					24	
28-12	26					26	
36A46	27					27	
24A28	28					28	
28A63	28				9	19	
32-8	30				6	24	
36-9	31		1	2	14	14	
28-15	35					35	
32-7	35				7	28	
36-15	35					35	
28-21	37					37	
36A98	39			8		31	

Contact arrangement	No. of contacts	Contact size					
		0 500	4 160	8 100 60	12 25	16 15	20 10
28A51	43					43	
32A47	47					47	
36-7	47				7	40	
36-8	47				1	46	
36-10	48					48	
36A34	52					52	
32A10	54					54	
32A55	55					55	
32A69	61					20	41
36A99	65					15	50

# Cannon VG/CA-Bayonet

## Contact Dimensions

### Box Mounting Receptacle

#### VG95234 – Style A

CA 3102E-B and Modifications, see page 12

Receptacle for front panel mounting with square flange.  
Threaded holes in flange not possible.

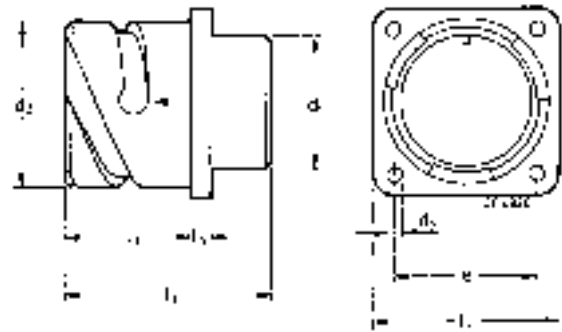

VG95234 Part no.	Cannon Part no.	d <sub>1</sub> max.	d <sub>2</sub> H13	d <sub>3</sub> -0,15	l <sub>1</sub> ±0,3	l <sub>2</sub> +0,4	l <sub>3</sub> ±0,2	l <sub>4</sub> ±0,3	Weight <sup>1)</sup> g max.
VG95234A-10SL	CA3102E10SL-**-B	16,2	3,2	18,2	24,7	14,2	2,8	25,4	12
-	CA3102E12S-**-B	16,2	3,2	21,4	24,7	14,2	3,2	28,0	15
VG95234A-14S	CA3102E14S-**-B	19,2	3,2	24,6	24,7	14,2	3,2	30,0	17
VG95234A-16S	CA3102E16S-**-B	22,4	3,2	27,4	24,7	14,2	3,2	32,5	19
VG95234A-16	CA3102E16-**-B	22,4	3,2	27,4	33,8	19,0	3,2	32,5	22
VG95234A-18	CA3102E18-**-B	25,6	3,2	30,8	33,8	19,0	4,0	35,0	28
VG95234A-20	CA3102E20-**-B	29,0	3,2	34,2	33,8	19,0	4,0	38,0	33
VG95234A-22	CA3102E22-**-B	32,2	3,2	37,4	33,8	19,0	4,0	41,0	38
VG95234A-24	CA3102E24-**-B	35,3	3,7	40,9	33,8	20,6	4,0	44,5	46
VG95234A-28	CA3102E28-**-B	41,4	3,7	46,7	33,8	20,6	4,0	50,8	52
VG95234A-32	CA3102E32-**-B	47,8	4,3	53,4	33,8	22,2	4,0	57,0	64
VG95234A-36	CA3102E36-**-B	52,6	4,3	59,6	33,8	22,2	4,0	63,5	80

<sup>1)</sup> Weight without insulator

CA02L-B designates a receptacle for front panel mounting with solder pin contacts to solder into printed circuits. All pattern drawings upon request. For all other dimensions see above table.

For contact arrangements with #16 and #12 contacts only.  
#12 contacts available upon request.

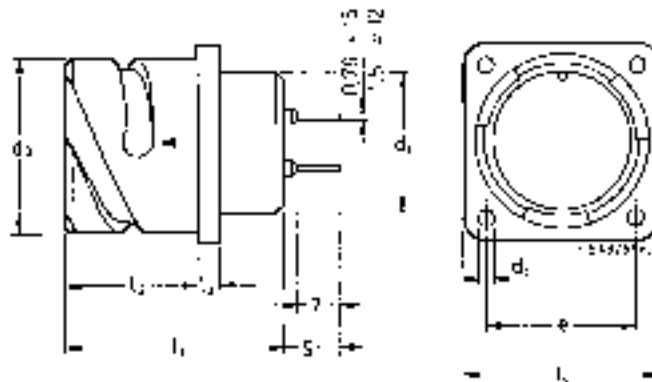

# Cannon VG/CA-Bayonet

## Box Mounting Receptacle

**VG95234 Style B1** (with threaded holes in flange)

**CA3102-B** and Modifications, e.g. -04, -109 or -111

**CA3102-B** designates a receptacle with square flange for rear panel mounting.

**VG95234 Style B2** (with through holes in flange)

**CA3102E-B** and Modifications, see page 12

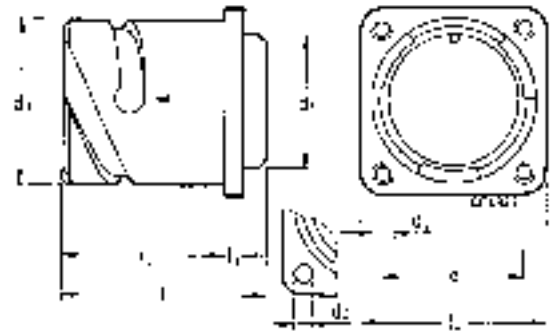

Style B2

VG95234 Part no.	Cannon Part no.	d <sub>1</sub> max.	d <sub>2</sub> B1 H13	B2	d <sub>3</sub> -0,15	l <sub>1</sub> ±0,3	l <sub>2</sub> +0,4	l <sub>3</sub> ±0,2	l <sub>4</sub> ±0,3	Weight <sup>1)</sup> g max.
VG95234XX-10SL-*	CA3102E10SL-*B-***	16,2	M4	3,2	18,2	24,7	18,2	2,8	25,4	14
-	CA3102E12S-*B-***	16,2	M4	3,2	21,4	24,7	18,2	3,2	28,0	18
VG95234XX-14S-*	CA3102E14S-*B-***	19,2	M4	3,2	24,6	24,7	18,2	3,2	30,0	21
CG95234XX-16S-*	CA3102E16S-*B-***	22,4	M4	3,2	27,4	24,7	18,2	3,2	32,5	22
VG95234XX-16-*	CA3102E16-*B-***	22,4	M4	3,2	27,4	33,8	21,5	3,2	32,5	27
VG95234XX-18-*	CA3102E18-*B-***	25,6	M4	3,2	30,8	33,8	23,05	4,0	35,0	33
VG95234XX-20-*	CA3102E20-*B-***	29,0	M4	3,2	34,2	33,8	23,05	4,0	38,0	37
VG95234XX-22-*	CA3102E22-*B-***	32,2	M4	3,2	37,4	33,8	23,05	4,0	41,0	42
VG95234XX-24-*	CA3102E24-*B-***	35,3	M4	3,7	40,9	33,8	23,05	4,0	44,5	48
VG95234XX-28-*	CA3102E28-*B-***	41,4	M5	3,7	46,7	33,8	24,05	4,0	50,8	58
VG95234XX-32-*	CA3102E32-*B-***	47,8	M5	4,3	53,4	33,8	24,05	4,0	57,0	72
VG95234XX-36-*	CA3102E36-*B-***	54,1	M5	4,3	59,6	33,8	24,05	4,0	63,5	84

<sup>1)</sup> Weight without insulator

**CA20L-B** designates a receptacle for rear panel mounting with solder pin contacts to solder into printed circuits. All pattern drawings upon request. For all other dimensions see above table.

For contact arrangements with #16 and #12 contacts only.  
#12 contacts available upon request.

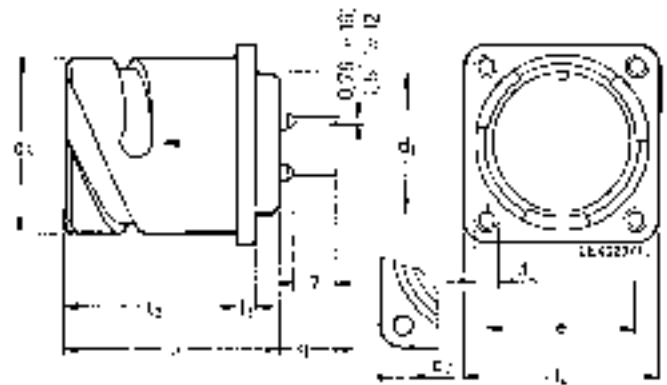

Mod. -05



# Cannon VG/CA-Bayonet

## Thru-Bulkhead Receptacle

**VG95234 Style C1** resp. **TBF-B** (with threaded holes)  
**VG95234 Style C2** resp. **TBF-B-05** (with flange through holes)

TBF-B designates a bulkhead receptacle with mounting flange.

Modifications see page 12

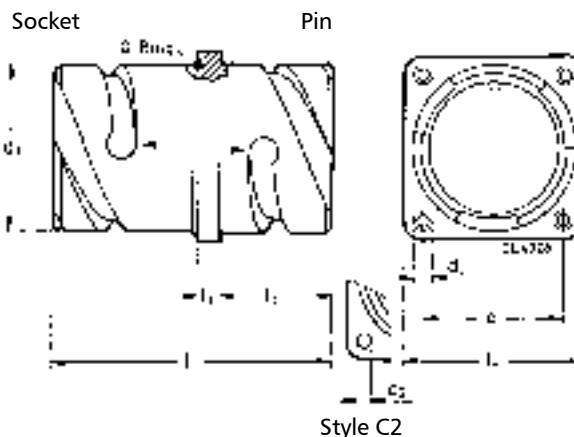

VG95234 Part no.	Cannon Part no.	d <sub>2</sub> C1	d <sub>2</sub> C2 H13	d <sub>2</sub> -0,15	e ±0,1	l <sub>1</sub> ±0,7	l <sub>2</sub> +0,3	l <sub>3</sub> ±0,2	l <sub>4</sub> ±0,3	Weight <sup>1)</sup> g max.
VG95234XX-10SL-*	TBF10SL-*B-***	M4	3,2	18,2	18,2	37,5	14,2	2,8	25,4	17
-	TBF12S-*B-***	M4	3,2	21,4	20,6	37,5	14,2	3,2	28,0	24
VG95234XX-14S-*	TBF14S-*B-***	M4	3,2	24,6	23,0	37,5	14,2	3,2	30,0	29
CG95234XX-16S-*	TBF16S-*B-***	M4	3,2	27,4	24,6	37,5	14,2	3,2	32,5	34
VG95234XX-16-*	TBF16-*B-***	M4	3,2	27,4	24,6	51,4	19,0	3,2	32,5	41
VG95234XX-18-*	TBF18-*B-***	M4	3,2	30,8	27,0	51,4	19,0	4,0	35,0	49
VG95234XX-20-*	TBF20-*B-***	M4	3,2	34,2	29,4	51,4	19,0	4,0	38,0	56
VG95234XX-22-*	TBF22-*B-***	M4	3,2	37,4	31,8	51,4	19,0	4,0	41,0	61
VG95234XX-24-*	TBF24-*B-***	M4	3,7	40,9	34,9	51,4	20,6	4,0	44,5	65
VG95234XX-28-*	TBF28-*B-***	M5	3,7	46,7	39,7	51,4	20,6	4,0	50,8	76
VG95234XX-32-*	TBF32-*B-***	M5	4,3	53,4	44,5	51,4	22,2	4,0	57,0	92
VG95234XX-36-*	TBF36-*B-***	M5	4,3	59,6	49,2	51,4	22,2	4,0	63,5	103

<sup>1)</sup> Weight without insulator, grommets and contacts.

## Straight Plug

**CA3106E-B** designates a straight plug with endbell, cable clamp and telescoping bushing

**VG95234 Style D** resp.

**CA3106E-B** and Modifications, see page 12

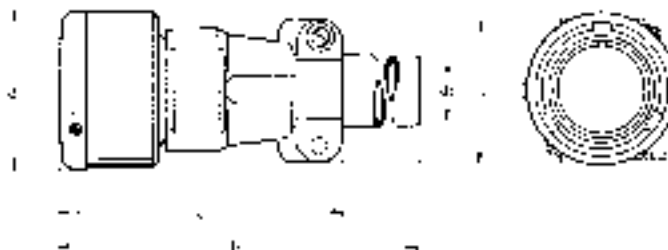

VG95234 Part no.	Cannon Part no.	d <sub>1</sub> max.	d <sub>2</sub> <sup>2)</sup> max.	l <sub>1</sub> max.	l <sub>2</sub> max.	l <sub>3</sub> max.	l <sub>4</sub> max.	Weight <sup>1)</sup> g max.
VG95234D-10SL-*	CA3106E10SL-***B-***	22,8	6,5	115	55	22,7	22,7	30
	CA3106E12S-***B-***	26,0	6,5	115	55	22,7	22,7	37
VG95234D-14S-*	CA3106E14S-***B-***	29,2	9,0	115	60	27,5	27,5	44
VG95234D-16S-*	CA3106E16S-***B-***	32,0	11,0	115	60	30,0	30,0	54
VG95234D-16-*	CA3106E16-***B-***	32,0	11,0	120	70	30,0	30,0	62
VG95234D-18-*	CA3106E18-***B-***	36,5	14,2	120	75	33,0	33,0	70
VG95234D-20-*	CA3106E20-***B-***	39,9	15,8	120	75	37,5	37,5	85
VG95234D-22-*	CA3106E22-***B-***	43,1	15,8	120	75	37,5	37,5	92
VG95234D-24-*	CA3106E24-***B-***	46,6	21,4	120	90	43,3	43,3	127
VG95234D-28-*	CA3106E28-***B-***	53,4	21,4	120	90	48,0	43,3	154
VG95234D-32-*	CA3106E32-***B-***	60,1	26,7	120	90	55,0	51,7	199
VG95234D-36-*	CA3106E36-***B-***	66,3	31,7	130	100	58,0	58,0	260

<sup>1)</sup> Weight without insulator, grommets and contacts.

<sup>2)</sup> For max. cable entry.

# Cannon VG/CA-Bayonet

## Plug 90°

### VG95234 Style E1 (with flex tube)

CA 3108 F-B and Modifications, see page 9

CA3108E/F designates a plug 90°, which is available with cable clamp and bushing (E) or with flex tube termination (F)

VG95234 Style E (with cable clamp and telescoping bushing)

CA 3108E-B and Modifications, see page 12

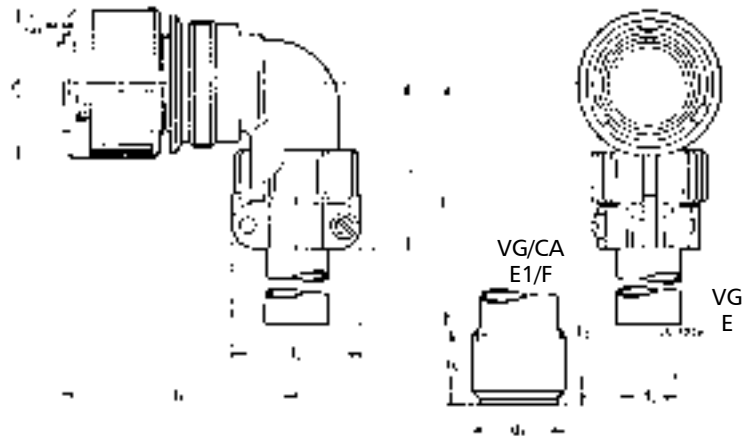

VG 95 234 Part no.	Cannon Part no.	d <sub>3</sub> -Thread Style E1 CA3108F	d <sub>1</sub> max.	d <sub>2</sub> <sup>2)</sup> max.	l <sub>1</sub> max.	l <sub>2</sub> max. E	l <sub>3</sub> max.		l <sub>4</sub> max.	l <sub>5</sub>	Weight <sup>1)</sup> g	
							E1	E			E	E1
VG95234XX-10SL-*	CA3108X10SL-**B-***	5/8-24NEF-2A	22,8	6,5	45	42	30	100	22,7	9,4	37	27
-	CA3108X12S-**B-***	5/8-24NEF-2A	26,0	6,5	45	42	30	100	22,7	9,4	45	35
VG95234XX-14S-*	CA3108X14S-**B-***	3/4-20UNEF-2A	29,2	9,0	47	42	30	100	27,5	9,4	58	43
VG95234XX-16S-*	CA3108X16S-**B-***	7/8-20UNEF-2A	32,0	11,0	48	45	30	100	30,0	9,4	68	48
VG95234XX-16-*	CA3108X16-**B-***	7/8-20UNEF-2A	32,0	11,0	57	45	30	100	30,0	9,4	78	58
VG95234XX-18-*	CA3108X18-**B-***	1-20UNEF-2A	36,5	14,2	58	53	35	100	33,0	9,4	90	58
VG95234XX-20-*	CA3108X20-**B-***	1 3/16-18UNEF-2A	39,9	15,8	61	53	35	100	37,5	9,4	109	74
VG95234XX-22-*	CA3108X22-**B-***	1 3/16-18UNEF-2A	43,1	15,8	61	53	35	100	37,5	9,4	113	78
VG95234XX-24-*	CA3108X24-**B-***	1 7/16-18UNEF-2A	46,6	21,4	66	58	40	100	43,3	9,4	159	104
VG95234XX-28-*	CA3108X28-**B-***	1 7/16-18UNEF-2A	53,4	21,4	66	58	40	100	43,3	9,4	181	126
VG95234XX-32-*	CA3108X32-**B-***	1 3/4 -18UNS-2A	60,1	26,7	72	66	45	110	51,7	11,0	245	160
VG95234XX-36-*	CA3108 36-**B-***	2 -18UNS-2A	66,3	31,7	75	69	50	110	58,0	12,6	300	190

<sup>1)</sup> Weight without insulator, grommets and contacts.

<sup>2)</sup> For max. cable entry.

## Straight Plug

### VG95234 Style F

CA3101E-B designates a cable connection plug with cable clamp and and telescoping bushing

CA 3101E-B and Modifications, see page 12

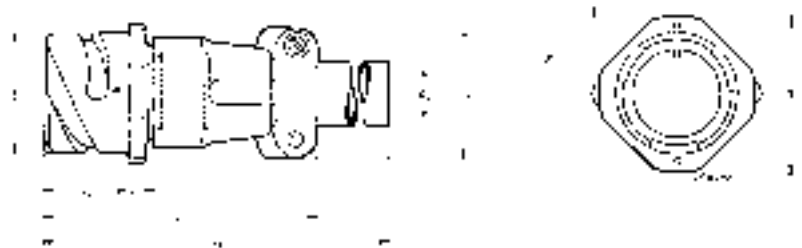

VG95234 Part no.	Cannon Part no.	d <sub>1</sub> max.	d <sub>2</sub> <sup>2)</sup>	d <sub>3</sub> -0,15	l <sub>1</sub> max.	l <sub>2</sub> ±0,1	l <sub>3</sub> ±0,2	l <sub>4</sub> max.	l <sub>5</sub> ±0,2	l <sub>7</sub> max.	Weight <sup>1)</sup> g max.
VG95234F-10SL-*	CA3101E10SL-**B-***	25,2	6,5	18,2	57	18,2	2,8	120	20,6	22,7	35
-	CA3101E12S-**B-***	27,8	6,5	21,4	57	18,2	3,2	120	23,6	22,7	43
VG95234F-14S-*	CA3101E14S-**B-***	29,8	9,0	24,6	59	18,2	3,2	120	25,4	27,5	50
VG95234F-16S-*	CA3101E16S-**B-***	32,3	11,0	27,4	60	18,2	3,2	120	28,6	30,0	60
VG95234F-16-*	CA3101E16-**B-***	32,3	11,0	27,4	68	21,5	3,2	125	28,6	30,0	65
VG95234F-18-*	CA3101E18-**B-***	34,8	14,2	30,8	72	23,05	4,0	125	31,7	33,0	80
VG95234F-20-*	CA3101E20-**B-***	37,8	15,8	34,2	72	23,05	4,0	125	34,9	37,5	95
VG95234F-22-*	CA3101E22-**B-***	41,1	15,8	37,4	72	23,05	4,0	125	38,1	37,5	105
VG95234F-24-*	CA3101E24-**B-***	44,6	21,4	40,9	78	23,05	4,0	125	41,3	43,3	140
VG95234F-28-*	CA3101E28-**B-***	50,9	21,4	46,7	79	24,05	4,0	125	47,6	43,3	160
VG95234F-32-*	CA3101E32-**B-***	57,1	26,7	53,4	78	24,05	4,0	125	54,0	51,7	205
VG95234F-36 <sup>3)</sup> -*	CA3101E36 <sup>3)</sup> -**B-***	63,6	31,7	59,6	78	24,05	4,0	135	60,6	58,0	270

<sup>1)</sup> Weight without insulator, grommets and contacts.

<sup>2)</sup> For contact insert 36-5P a support washer is included.

<sup>2)</sup> For max. cable entry.

# Cannon VG/CA-Bayonet

## Straight Plug

### VG95234 – Style G

CA3106E-B, -02, -03 or -06 designates a straight plug with adapter for heat shrinkable boots

CA3106E-B and Modifications, see page 12

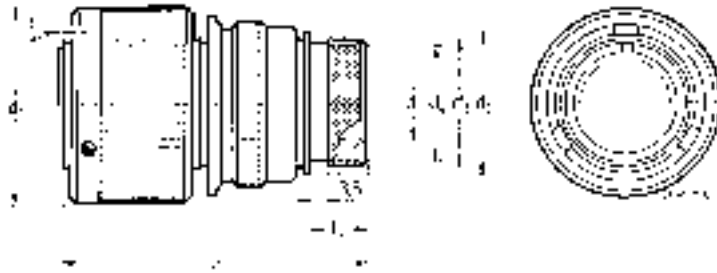

VG95234 Part no.	Cannon Part no.	d <sub>1</sub> max.	d <sub>2</sub> ±0,2	d <sub>3</sub> ±0,2	d <sub>4</sub> max.	d <sub>5</sub> min.	l <sub>1</sub> max.	l <sub>2</sub> ±0,5	Weight <sup>1)</sup> g max.
VG95234G-10SL-*	CA3106E10SL-***B-***	22,8	17,0	15,5	13,3	7,7	50	11,7	24
-	CA3106E12S-***B-***	26,0	17,8	15,5	13,3	7,9	50	11,7	35
VG95234G-14S-*	CA3106E14S-***B-***	29,2	20,1	19,1	17,0	10,6	50	11,7	41
VG95234G-16S-*	CA3106E16S-***B-***	32,0	23,5	23,9	21,9	13,5	50	11,7	51
VG95234G-16-*	CA3106E16-***B-***	32,0	23,5	23,9	21,9	13,5	60	11,7	58
VG95234G-18-*	CA3106E18-***B-***	36,5	26,5	23,9	21,9	14,6	60	11,7	65
VG95234G-20-*	CA3106E20-***B-***	39,9	30,2	29,6	26,2	18,7	65	12,7	75
VG95234G-22-*	CA3106E22-***B-***	43,1	33,6	29,6	26,2	20,8	65	12,7	80
VG95234G-24-*	CA3106E24-***B-***	46,6	38,1	37,8	34,5	24,6	65	12,7	95
VG95234G-28-*	CA3106E28-***B-***	53,4	41,4	37,8	34,5	27,0	65	12,7	120
VG95234G-32-*	CA3106E32-***B-***	60,1	48,6	47,8	43,6	33,3	70	15,2	165
VG95234G-36-*	CA3106E36-***B-***	66,3	54,8	47,8	43,6	38,5	80	15,2	180

<sup>1)</sup> Weight without insulator, grommets and contacts.

## Straight Plug

### VG95234 Style H

CA3106-F-B designates a straight plug for flex tube

CA3106-B and Modifications, see page 12

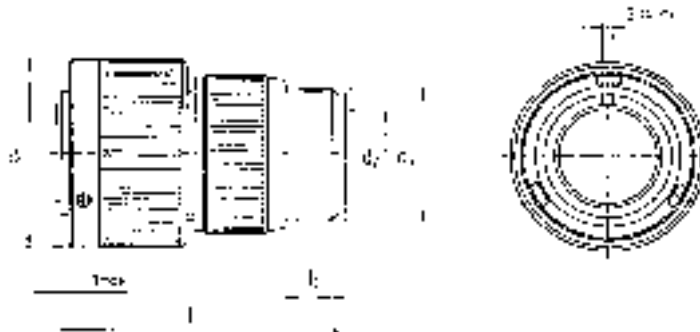

VG95234 Part no.	Cannon Part no.	d <sub>3</sub> -Thread	d <sub>1</sub> max.	d <sub>2a</sub> <sup>2)</sup>	l <sub>1</sub> max.	l <sub>2</sub> min.	Weight <sup>1)</sup> g max.
VG95234H-10SL-*	CA3106F10SL-***B-***	5/8-24NEF-2A	22,8	8,2	50	9,5	21
-	CA3106F12S-***B-***	5/8-24NEF-2A	26,0	8,2	50	9,5	29
VG95234H-14S-*	CA3106F14S-***B-***	3/4-20UNEF-2A	29,2	11,1	50	9,5	33
VG95234H-16S-*	CA3106F16S-***B-***	7/8-20UNEF-2A	32,0	14,3	50	9,5	42
VG95234H-16-*	CA3106F16-***B-***	7/8-20UNEF-2A	32,0	14,3	60	9,5	51
VG95234H-18-*	CA3106F18-***B-***	1-20UNEF-2A	36,5	16,7	60	9,5	59
VG95234H-20-*	CA3106F20-***B-***	1 3/16-18UNEF-2A	39,9	19,8	60	9,5	59
VG96234H-22-*	CA3106F22-***B-***	1 3/16-18UNEF-2A	43,1	19,8	60	9,5	62
VG95234H-24-*	CA3106F24-***B-***	1 7/16-18UNEF-2A	46,6	25,4	65	9,5	84
VG95234H-28-*	CA3106F28-***B-***	1 7/16-18UNEF-2A	53,4	27,0	65	9,5	100
VG95234H-32-*	CA3106F32-***B-***	1 3/4-18UNS-2A	60,1	32,5	65	11,0	116
VG95234H-36-*	CA3106F36-***B-***	2-18UNS-2A	66,3	35,7	80	11,8	142

<sup>1)</sup> Weight without insulator, grommets and contacts.

<sup>2)</sup> For max. cable entry.

# Cannon VG/CA-Bayonet

## Wall Mounting Receptacle

for rear mounting

**VG95234 Style J<sub>1</sub>** (with threaded holes in flange)

**VG95234 Style J<sub>2</sub>** (with through holes in flange)

**CA3100E-B** and Modifications e g -05  
(with through holes)

**CA3100E-B** designates a wall mounting  
receptacle with cable clamp and telescoping  
bushing

**CA3100E-B** and Modifications e g -01, -F80  
(for ordered contacts)

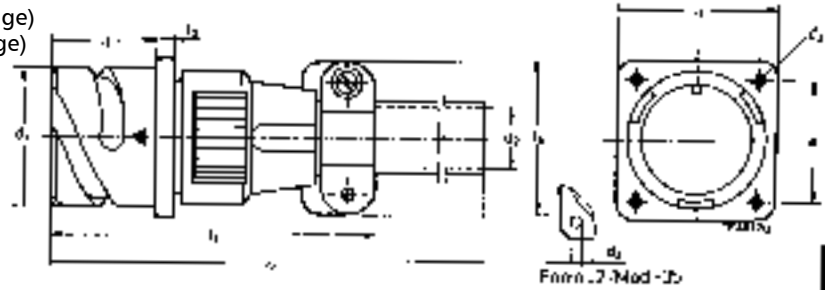

VG95234 Part no.	Cannon Part no.	d <sub>1</sub> -0,15	d <sub>2</sub> <sup>1)</sup>	J <sub>1</sub> d <sub>3</sub>	J <sub>2</sub>	l <sub>1</sub> max.	l <sub>2</sub> +0,4	l <sub>3</sub> ±0,2	l <sub>4</sub> ±0,3	l <sub>5</sub> max.
VG95234*XX-10SL-*	CA3100E10SL-**-B-***	18,2	6,5	M4	3,2	57	18,2	2,8	25,4	120
-	CA3100E12S-**-B-***	21,4	6,5	M4	3,2	57	18,2	3,2	28,0	120
VG95234*XX-14S-*	CA3100E14S-**-B-***	24,6	9,0	M4	3,2	59	18,2	3,2	30,0	120
VG95234*XX-16S-*	CA3100E16S-**-B-***	27,4	11,0	M4	3,2	60	18,2	3,2	32,5	120
VG95234*XX-16-*	CA3100E16-**-B-***	27,4	11,0	M4	3,2	68	21,5	3,2	32,5	125
VG95234*XX-18-*	CA3100E18-**-B-***	30,8	14,2	M4	3,2	72	23,05	4,0	35,0	125
VG95234*XX-20-*	CA3100E20-**-B-***	34,2	15,8	M4	3,2	72	23,05	4,0	38,0	125
VG95234*XX-22-*	CA3100E22-**-B-***	37,4	15,8	M4	3,2	72	23,05	4,0	41,0	125
VG95234*XX-24-*	CA3100E24-**-B-***	40,9	21,4	M4	3,7	78	23,05	4,0	44,5	125
VG95234*XX-28-*	CA3100E28-**-B-***	46,7	21,4	M5	3,7	79	24,05	4,0	50,8	125
VG95234*XX-32-*	CA3100E32-**-B-***	53,4	26,7	M5	4,3	78	24,05	4,0	57,0	125
VG95234*XX-36-*	CA3100E36-**-B-***	59,6	31,7	M5	4,3	78	24,05	4,0	63,5	135

<sup>1)</sup> For max. cable entry.

## Plug 90°, Shielded

### VG95234 Style K

**CA3108F-B-13, -14 or -15** designates a shielded plug  
with 90° endbell for flex tube, grounding spring on the  
barrel. No rear accessories to mount cable braid to the  
endbell.

**CA3108F** and Modifications, see page 12

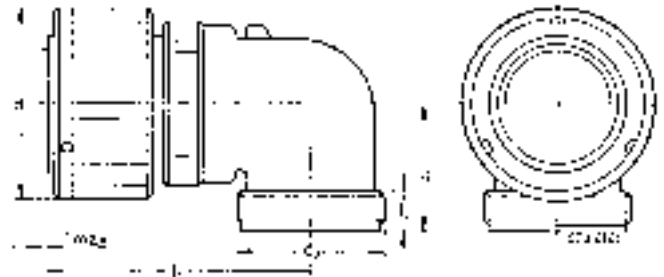

VG96234 Part no.	Cannon Part no.	d <sub>3</sub> -Thread	d <sub>1</sub> max.	l <sub>1</sub> max.	l <sub>2</sub> max.	l <sub>3</sub> min.	Weight <sup>1)</sup> g max.
-	CA3108F10SL-**-B-***	5/8-24UNEF-2A	22,8	45	22	9,4	27
VG95234K-12S-*	CA3108F12S-**-B-***	5/8-24UNEF-2A	26,0	45	22	9,4	35
VG95234K-14S-*	CA3108F14S-**-B-***	3/4-20UNEF-2A	29,2	47	24	9,4	43
VG95234K-16S-*	CA3108F16S-**-B-***	7/8-20UNEF-2A	32,0	48	25	9,4	48
VG95234K-16-*	CA3108F16-**-B-***	7/8-20UNEF-2A	32,0	57	25	9,4	58
VG95234K-18-*	CA3108F18-**-B-***	1-20UNEF-2A	36,5	58	27	9,4	58
VG95234K-20-*	CA3108F20-**-B-***	1 3/16-18UNEF-2A	39,9	61	29	9,4	74
VG95234K-22-*	CA3108F22-**-B-***	1 3/16-18UNEF-2A	43,1	61	30	9,4	78
VG95234K-24-*	CA3108F24-**-B-***	1 7/16-18UNEF-2A	46,6	66	32	9,4	104
VG95234K-28-*	CA3108F28-**-B-***	1 7/16-18UNEF-2A	53,4	66	34	9,4	126
CG95234K-32-*	CA3108F32-**-B-***	1 3/4-18UNS-2A	60,1	72	39,5	11,0	160
VG95234K-36-*	CA3108F36-**-B-***	2-18UNS-2A	66,3	75	45	12,6	190

<sup>1)</sup> Weight without insulator, grommets and contacts.

# Cannon VG/CA-Bayonet

## Straight Plug, shielded

### VG95234 Style L

CA3106F-B-13, -14 or -15 designates a straight plug with endbell for flex tube, grounding spring on the barrel.

CA3106F-B and Modifications, see page 12



VG95234 Part no.	Cannon Part no.	d <sub>3</sub> -Thread	d <sub>1</sub>	d <sub>2</sub> <sup>2)</sup> max.	l <sub>1</sub>	l <sub>2</sub> min.	Weight <sup>1)</sup> g max.
VG95234L-10SL-*	CA3106F10SL-**-B-***	5/8-24UNEF-2A	22,8	8,2	50	9,5	21
VG95234L-12S-*	CA3106F12S-**-B-***	5/8-24UNEF-2A	26,0	8,2	50	9,5	29
VG95234L-14S-*	CA3106F14S-**-B-***	3/4-20UNEF-2A	29,2	11,1	50	9,5	33
VG95234L-16S-*	CA3106F16S-**-B-***	7/8-20UNEF-2A	32,0	14,3	50	9,5	42
VG95234L-16-*	CA3106F-16-**-B-***	7/8-20UNEF-2A	32,0	14,3	60	9,5	51
VG95234L-18-*	CA3106F-18-**-B-***	1-20UNEF-2A	36,5	16,7	60	9,5	59
VG95234L-20-*	CA3106F-20-**-B-***	1 3/16-18UNEF-2A	39,9	19,8	60	9,5	58
VG95234L-22-*	CA3106F-22-**-B-***	1 3/16-18UNEF-2A	43,1	19,8	60	9,5	62
VG95234L-24-*	CA3106F-24-**-B-***	1 7/16-18UNEF-2A	46,6	25,4	65	9,5	84
VG95234L-28-*	CA3106F-28-**-B-***	1 7/16-18UNEF-2A	53,4	27,0	65	9,5	100
VG95234L-32-*	CA3106F-32-**-B-***	1 3/4-18UNS-2A	60,1	32,5	65	11,0	116
VG95234L-36-*	CA3106F-36-**-B-***	2-18UNS-2A	66,3	35,7	80	11,8	142

<sup>1)</sup> Weight without insulator, grommets and contacts.

<sup>2)</sup> For max. cable entry.

## Straight Plug, shielded

### VG95234 Style M

CA3106E-B-13, -14 or -15 designates a straight, shielded plug with endbell for shielded braids and heat shrinkable boots, grounding spring on the barrel.

CA3106E-B and Modifications, see page 12



VG95234 Part no.	Cannon Part no.	d <sub>1</sub> max.	d <sub>2</sub> <sup>2)</sup> min.	d <sub>3</sub> ±0,5	d <sub>4</sub> max.	l <sub>1</sub> max.	l <sub>2</sub> +1	l <sub>3</sub> ±0,5	Weight <sup>1)</sup> g max.
VG95234M-10SL-*	CA3106E10SL-**-B-***	22,8	7,7	18,5	16,3	55,0	17,0	7,0	40
-	CA3106E12S-**-B-***	26,0	9,3	20,0	17,0	55,0	17,0	7,0	42
VG95234M-14S-*	CA3106E14S-**-B-***	29,2	10,6	22,0	20,0	55,0	17,0	7,0	45
VG95234M-16S-*	CA3106E16S-**-B-***	32,0	13,5	25,0	23,0	60,0	18,0	8,0	55
VG95234M-16-*	CA3106E16-**-B-***	32,0	13,5	25,0	23,0	70,0	18,0	8,0	65
VG95234M-18-*	CA3106E18-**-B-***	36,5	14,6	28,0	24,5	70,0	18,0	8,0	75
VG95234M-20-*	CA3106E20-**-B-***	39,9	18,5	32,0	28,5	70,0	18,0	10,0	85
VG95234M-22-*	CA3106E22-**-B-***	43,1	20,8	34,0	30,5	70,0	18,0	10,0	100
VG95234M-24-*	CA3106E24-**-B-***	46,6	24,6	38,0	34,5	70,0	18,0	10,0	115
VG95234M-28-*	CA3106E28-**-B-***	53,4	27,0	41,0	37,5	70,0	18,0	10,0	130
VG95234M-32-*	CA3106E32-**-B-***	60,1	33,3	48,0	44,0	70,0	18,0	10,0	170
VG95234M-36-*	CA3106E36-**-B-***	66,3	38,5	55,0	51,0	80,0	18,0	10,0	190

<sup>1)</sup> Weight without insulator, grommets and contacts.

<sup>2)</sup> For max. cable entry.

# Cannon VG/CA-Bayonet

## Wall Mounting Receptacle

**VG95234 Style N1** (with threaded holes in flange)  
**VG95234 Style N2** (with through holes in flange)

**CA3100E-B**, -13, -14 or -15, -05-13, -05-14 or -05-15 designates a shielded receptacle with endbell for shielding braids, and also for heat shrinkable boots

**CA3100E-B** and Modifications, see page 12



VG95234 Part no.	Cannon Part no.	d <sub>1</sub> -0,15	d <sub>2</sub> Thread H13		d <sub>3</sub> ±0,5	d <sub>4</sub> <sup>2)</sup> min.	d <sub>5</sub> max.	e ±0,1	l <sub>1</sub> max.	l <sub>2</sub> +0,4	l <sub>3</sub> ±0,2	l <sub>4</sub> +0,3	Weight <sup>1)</sup> g max.
			N1	N2									
VG95234*XX-10SL-*	CA3100E10SL-**-B-***	18,2	M4	3,2	18,5	7,7	16,3	18,2	55	18,2	2,8	25,4	45
VG95234*XX-14S-*	CA3100E14S-**-B-***	24,6	M4	3,2	22,0	10,6	20,0	23,0	58	18,2	3,2	30,0	55
VG95234*XX-16S-*	CA3100E16S-**-B-***	27,4	M4	3,2	25,0	13,5	23,0	24,6	70	18,2	3,2	32,5	65
VG95234*XX-16-*	CA3100E16-**-B-***	27,4	M4	3,2	25,0	13,5	23,0	24,6	70	21,5	3,2	32,5	75
VG95234*XX-18-*	CA3100E18-**-B-***	30,8	M4	3,2	28,0	14,6	24,5	27,0	70	23,05	4,0	35,0	85
VG95234*XX-20-*	CA3100E20-**-B-***	34,2	M4	3,2	32,0	18,5	28,5	29,4	70	23,05	4,0	38,4	95
VG95234*XX-22-*	CA3100E22-**-B-***	37,4	M4	3,2	34,0	20,8	30,5	31,8	70	23,05	4,0	41,0	105
VG95234*XX-24-*	CA3100E24-**-B-***	40,9	M4	3,7	38,0	24,6	34,5	34,9	70	23,05	4,0	44,5	120
VG95234*XX-28-*	CA3100E28-**-B-***	46,7	M5	3,7	41,0	27,0	37,5	39,7	70	24,05	4,0	50,8	150
VG95234*XX-32-*	CA3100E32-**-B-***	53,4	M5	4,3	48,0	33,3	44,0	44,5	75	24,05	4,0	57,0	190
VG95234*XX-36-*	CA3100E36-**-B-***	59,6	M5	4,3	55,0	38,5	51,0	49,2	85	24,05	4,0	63,5	220

<sup>1)</sup> Weight without insulator, grommets and contacts.

<sup>2)</sup> For max. cable entry.

## Straight Plug

**VG95234 Style R1** (designated as shielded plug)

**CA3106E-B**, -32-DXX designates a straight plug, shielded, with endbell for system cable.

Grounding spring on the barrel.

(DXX means cable entry diameter)

**CA3106E-B** and Modification, see page 12

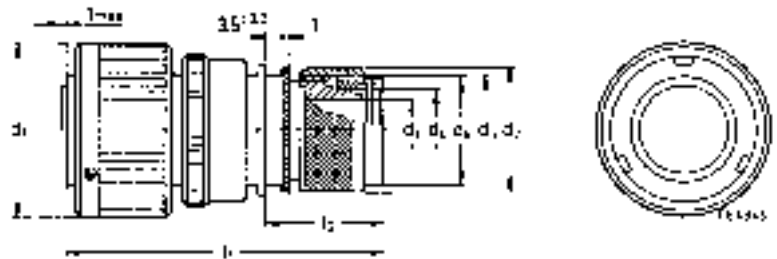

VG95234 Part no.	Cannon Part no.	d <sub>1</sub>	d <sub>3</sub>	d <sub>4</sub>	d <sub>5</sub>	d <sub>6</sub>	d <sub>7</sub>	l <sub>1</sub>	l <sub>2</sub>	Weight <sup>1)</sup> g max.
VG95234R1-14S	CA3106E14S-**-B-32	29,2	10,0	14,0	M 20x1	21,0	23,5	57	21,0	50
VG95234R1-16S	CA3106E16S-**-B-32	32,0	10,0	14,0	M 20x1	21,0	23,5	57	21,0	60
-	CA3106E16S-**-B-32-D12	32,0	12,2	16,0	M 22x1	23,0	25,5	57	21,0	60
VG95234R1-18	CA3106E18-**-B-32	36,5	12,2	16,0	M 22x1	23,0	25,5	66	21,0	80
VG95234R1-20	CA3106E20-**-B-32	39,9	13,4	18,0	M 27x1	26,6	30,5	68	21,0	90
-	CA3106E20-**-B-32-D19	39,9	19,6	22,6	M 27x1	31,5	35,5	68	21,0	90
VG95234R1-28	CA3106E28-**-B-32	53,4	19,0	26,0	M 35x1	37,6	41,5	76	26,0	135
-	CA3106E28-**-B-32-D22	53,4	23,0	26,5	M 35x1	37,6	41,5	76	26,0	135
VG95234R1-32	CA3106E32-**-B-32	60,1	21,0	26,5	M 35x1	37,5	41,5	79	26,0	175
-	CA3106E32-**-B-32-D22	60,3	23,0	26,5	M 35x1	37,5	41,5	82	26,0	200
-	CA3106E36-**-B-32-D22	66,3	23,0	26,5	M 42x1	37,5	41,5	82	26,0	200
-	CA3106E36-**-B-32-D26	66,3	27,0	33,0	M 42x1	45,0	49,7	82	26,0	200

<sup>1)</sup> Weight without insulator, grommets and contacts.

# Cannon VG/CA-Bayonet

## Wall Mounting Receptacle

**VG95234 Style S1** (with thread holes in flange)

**CA3100E-B, -32, -32-05** designates a wall mounting receptacle, shielded, with endbell for system cable acc. MTV 6145-005.

**CA3100E-B** and Modification, see page 12

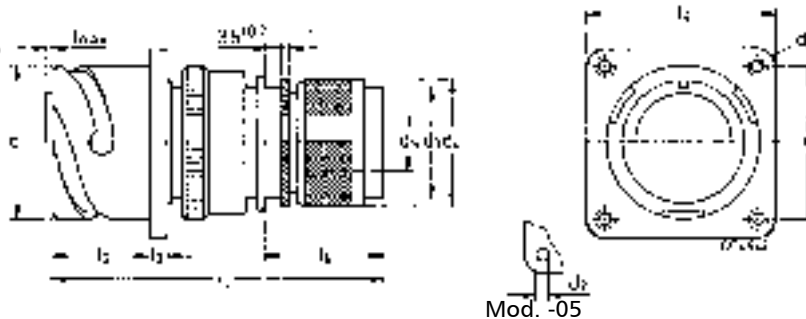

VG95234 Part no.	Cannon Part no.	d <sub>1</sub> -0,15	d <sub>2</sub> Thread H13	d <sub>3</sub>	d <sub>4</sub> ±0,3	d <sub>5</sub>	e ±0,1	l <sub>1</sub> max.	l <sub>2</sub> ±0,4	l <sub>3</sub> ±0,2	l <sub>4</sub> ±0,3	l <sub>5</sub> max.	
VG95234S1-14S	CA3100E14S-**-B-***	24,6	M4	3,2	21,0	23,5	10,0	23,0	61	18,2	3,2	30,0	21,0
VG95234S1-16S	CA3100E16S-**-B-***	27,4	M4	3,2	21,0	23,5	10,0	24,6	61	18,2	3,2	32,5	21,0
VG95234S1-18	CA3100E18-**-B-***	30,8	M4	3,2	23,0	25,5	12,2	27,0	70	23,05	4,0	35,0	21,0
VG95234S1-20	CA3100E20-**-B-***	34,2	M4	3,2	26,6	30,5	13,4	29,4	72	23,05	4,0	38,0	21,0
VG95234S1-28	CA3100E28-**-B-***	46,7	M5	3,7	37,5	41,5	19,0	39,7	78	24,05	4,0	50,8	26,0
VG95234S1-32	CA3100E32-**-B-***	53,4	M5	4,3	37,5	41,5	21,0	44,5	81	24,05	4,0	57,0	26,0

## Straight Plug, Shielded with Adapter for Heat Shrink Boots

**VG95234 Style T**

**CA3106E-B, 02-41, 03-41, 06-41** designates a straight plug, shielded ground spring on the barrel with endbell for heat shrink boot.

**CA3106E-B** and Modification, see page 12

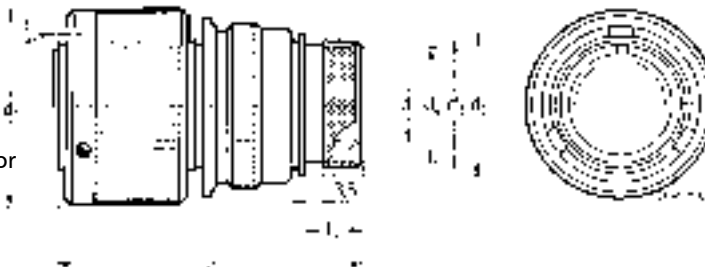

VG95234 Part no.	Cannon Part no.	d <sub>1</sub> max.	d <sub>2</sub> ±0,2	d <sub>3</sub> ±0,2	d <sub>4</sub> max.	d <sub>5</sub> min.	l <sub>1</sub> max.	l <sub>2</sub> ±0,5	Weight <sup>1)</sup> g max.
VG95234T-10SL-*	CA3106E10SL-**-B-***	22,8	17,0	15,5	13,3	7,7	50	11,7	24
-	CA3106E12S-**-B-***	26,0	17,8	15,5	13,3	7,9	50	11,7	35
VG95234T-14S-*	CA3106E14S-**-B-***	29,2	20,1	19,1	17,0	10,6	50	11,7	41
VG95234T-16S-*	CA3106E16S-**-B-***	32,0	23,5	23,9	21,9	13,5	50	11,7	51
VG95234T-16-*	CA3106E16-**-B-***	32,0	23,5	23,9	21,9	13,5	60	11,7	58
VG95234T-18-*	CA3106E18-**-B-***	36,5	26,5	23,9	21,9	14,6	60	11,7	65
VG95234T-20-*	CA3106E20-**-B-***	39,9	30,2	29,6	26,2	18,7	65	12,7	75
VG95234T-22-*	CA3106E22-**-B-***	43,1	33,6	29,6	26,2	20,8	65	12,7	80
VG95234T-24-*	CA3106E24-**-B-***	46,6	38,1	37,8	34,5	24,6	65	12,7	95
VG95234T-28-*	CA3106E28-**-B-***	53,4	41,4	37,8	34,5	27,0	65	12,7	120
VG95234T-32-*	CA3106E32-**-B-***	60,1	48,6	47,8	43,6	33,3	70	15,2	165
VG95234T-36-*	CA3106E36-**-B-***	66,3	54,8	47,8	43,6	38,5	80	15,2	180

<sup>1)</sup> Weight without insulator, grommets and contacts.

# Cannon VG/CA-Bayonet

## Wall Mounting Receptacle

**VG95234 Style U1** (with threaded holes in flange)  
**VG95234 Style U2** (with through holes in flange)

**CA3100E-B-02-05, -03-05 or -06-05, -02-03 or -06** designates a wall mounting receptacle with adapter for heat shrinkable boots

**CA3100E-B** and Modifications, see page 12

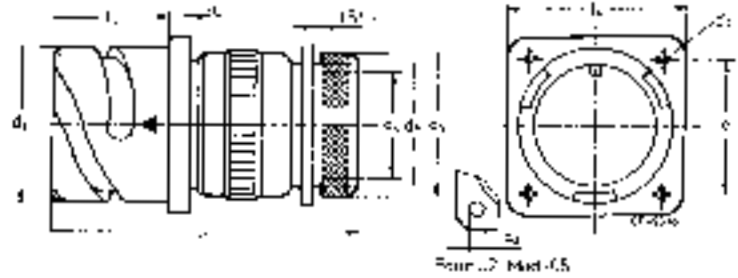

VG95234 Part no.	Cannon Part no.	d <sub>1</sub> -0,15	d <sub>2</sub> Thread H13	d <sub>3</sub> ±0,2	d <sub>4</sub>	d <sub>5</sub> max.	e ±0,1	l <sub>1</sub> max.	l <sub>2</sub> +0,4	l <sub>3</sub> ±0,2	l <sub>4</sub> ±0,3	Weight <sup>1)</sup> g max.	
VG95234U1-10SL-*	CA3100E10SL-**-B-***	18,2	M4	3,2	15,5	7,7	13,3	18,2	57	18,2	2,8	25,4	35
-	CA3100E12S-**-B-***	21,4	M4	3,2	15,5	7,9	13,3	20,6	57	18,2	3,2	28,0	45
VG95234U1-14S-*	CA3100E14S-**-B-***	24,6	M4	3,2	19,1	10,6	17,0	23,0	57	18,2	3,2	30,0	50
VG95234U1-16S-*	CA3100E16S-**-B-***	27,4	M4	3,2	23,9	13,5	21,9	24,6	57	18,2	3,2	32,5	60
VG95234U1-16-*	CA3100E16-**-B-***	27,4	M4	3,2	23,9	13,5	21,9	24,6	63	21,5	3,2	32,5	65
VG95234U1-18-*	CA3100E18-**-B-***	30,8	M4	3,2	23,9	14,6	21,9	27,0	65	23,05	4,0	35,0	80
VG95234U1-20-*	CA3100E20-**-B-***	34,2	M4	3,2	29,6	18,7	26,2	29,4	68	23,05	4,0	38,0	95
VG95234U1-22-*	CA3100E22-**-B-***	37,4	M4	3,2	29,6	20,8	26,2	31,8	68	23,05	4,0	41,0	105
VG95234U1-24-*	CA3100E24-**-B-***	40,9	M4	3,7	37,8	24,6	34,5	34,9	70	23,05	4,0	44,5	140
VG95234U1-28-*	CA3100E28-**-B-***	46,7	M5	3,7	37,8	27,0	34,5	39,7	71	24,05	4,0	50,8	160
VG95234U1-32-*	CA3100E32-**-B-***	53,4	M5	4,3	47,8	33,3	43,6	44,5	74	24,05	4,0	57,0	205
VG95234U1-36-*	CA3100E36-**-B-***	59,6	M5	4,3	47,8	38,5	43,6	49,2	74	24,05	4,0	63,5	270

<sup>1)</sup> Weight without insulator, grommets and contacts.

## Straight Plug

**VG95234 Style V**

**CA3101E-B, -02, -03 or -06** designates a cable connection plug with adapter for heat shrinkable boots

**CA3101E-B** and Modifications, see page 12

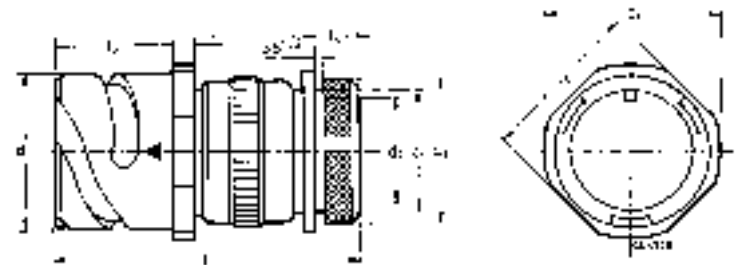

VG95234 Part no.	Cannon Part no.	d <sub>1</sub> -0,15	d <sub>2</sub> <sup>2)</sup> min.	d <sub>3</sub> ±0,2	d <sub>4</sub> max.	d <sub>5</sub> max.	l <sub>1</sub> max.	l <sub>2</sub> +0,4	l <sub>3</sub> ±0,2	l <sub>4</sub> ±0,5	l <sub>5</sub>	Weight <sup>1)</sup> g max.
VG95234V-10SL-*	CA3101E10SL-**-B-***	18,2	7,7	15,5	25,2	13,3	57	18,2	2,8	11,7	20,6	35
-	CA3101E12S-**-B-***	21,4	7,9	15,5	27,8	13,3	57	18,2	3,2	11,7	23,6	45
VG95234V-14S-*	CA3101E14S-**-B-***	24,6	10,6	19,1	29,8	17,0	57	18,2	3,2	11,7	25,4	50
VG95234V-16S-*	CA3101E16S-**-B-***	27,4	13,5	23,9	32,3	21,9	57	18,2	3,2	11,7	28,6	60
VG95234V-16-*	CA3101E16-**-B-***	27,4	13,5	23,9	32,3	21,9	63	21,5	3,2	11,5	28,6	65
VG95234V-18-*	CA3101E18-**-B-***	30,8	14,6	23,9	34,8	21,9	65	23,05	4,0	11,5	31,7	80
VG95234V-20-*	CA3101E20-**-B-***	34,2	18,7	29,6	37,8	26,2	68	23,05	4,0	12,7	34,9	95
VG95234V-22-*	CA3101E22-**-B-***	37,4	20,8	29,6	41,1	26,2	68	23,05	4,0	12,7	38,1	105
VG95234V-24-*	CA3101E24-**-B-***	40,9	24,6	37,8	44,6	34,5	70	23,05	4,0	12,7	41,3	140
VG95234V-28-*	CA3101E28-**-B-***	46,7	27,0	37,8	50,9	34,5	71	24,05	4,0	12,7	47,6	160
VG95234V-32-*	CA3101E32-**-B-***	53,4	33,3	47,8	57,1	43,6	74	24,05	4,0	15,2	54,0	205
VG95234V-36-*	CA3101E36-**-B-***	59,6	38,5	47,8	63,6	43,6	74	24,05	4,0	15,2	60,6	270

<sup>1)</sup> Weight without insulator, grommets and contacts.

<sup>2)</sup> For max. cable entry.



# Cannon VG/CA-Bayonet

## Wall Mounting Receptacle

CA3100E-B-08 (Flange with threaded holes)

CA3100E-B-09 (Flange with through holes)

CA3100E-B-08, -09 designates a wall mounting receptacle, with 90° endbell, cable clamp and telescoping bushing.

Modification see page 12

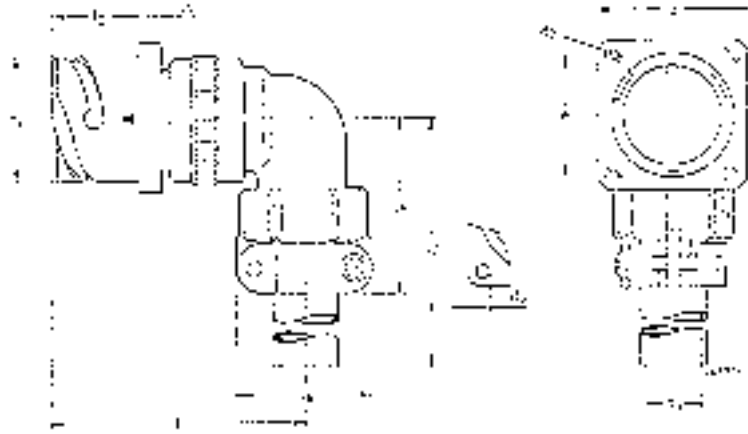

Cannon Part no.	d <sub>1</sub> -0,15	d <sub>2</sub>		d <sub>3</sub> <sup>2)</sup> max.	e ±0,4	l <sub>1</sub> max.	l <sub>2</sub> +0,4	l <sub>3</sub> ±0,2	l <sub>4</sub> max.	l <sub>5</sub> max.	l <sub>6</sub> max.	l <sub>7</sub> max.	Weight <sup>1)</sup> g max.
		Thread Mod. 08	H13 Mod. 09										
CA3100E10SL-**-B-***	18,2	M4	3,2	6,5	18,2	50	18,2	2,8	25,4	42	22,7	100	50
CA3100E12S-**-B-***	21,4	M4	3,2	6,5	20,6	50	18,2	3,2	28,0	42	22,7	100	60
CA3100E14S-**-B-***	24,6	M4	3,2	9,0	23,0	52	18,2	3,2	30,0	42	27,5	100	70
CA3100E16S-**-B-***	27,4	M4	3,2	11,0	24,6	53	18,2	3,2	32,5	45	30,0	100	80
CA3100E16-**-B-***	27,4	M4	3,2	11,0	24,6	60	21,5	3,2	32,5	45	30,0	100	90
CA3100E18-**-B-***	30,8	M4	3,2	14,2	27,0	62	23,05	4,0	35,0	53	33,0	100	100
CA3100E20-**-B-***	34,2	M4	3,2	15,8	29,4	66	23,05	4,0	38,0	53	37,5	100	120
CA3100E22-**-B-***	37,4	M4	3,2	15,8	31,8	66	23,05	4,0	41,0	53	37,5	100	130
CA3100E24-**-B-***	40,9	M4	3,7	21,4	34,9	69	23,05	4,0	44,5	58	43,3	100	170
CA3100E28-**-B-***	46,7	M5	3,7	21,4	39,7	70	24,05	4,0	50,8	58	43,3	100	200
CA3100E32-**-B-***	53,4	M5	4,3	26,7	44,5	74	24,05	4,0	57,0	66	51,7	110	265
CA3100E36-**-B-***	59,6	M5	4,3	31,7	49,2	78	24,05	4,0	63,5	69	58,0	110	325

<sup>1)</sup> Weight without insulator, grommets and contacts.

<sup>2)</sup> For max. cable entry.

## Wall Mounting Receptacle

CA3100F-B-08 (Flange with threaded holes)

CA3100F-B-09 (Flange with through holes)

CA3100F-B, -08, -09 designates a wall mounting receptacle with 90° endbell and for protective hose

Modifications see page 12

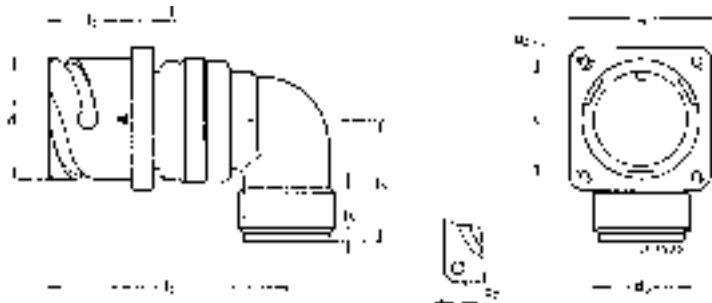

Mod -09

Cannon Part no.	d <sub>1</sub> -0,15	d <sub>2</sub>		d <sub>3</sub> Thread	e ±0,1	l <sub>1</sub> max.	l <sub>2</sub> +0,4	l <sub>3</sub> ±0,2	l <sub>4</sub> ±0,3	l <sub>5</sub> min.	l <sub>6</sub> max.	Weight <sup>1)</sup> g max.
		Thread	H13									
CA3100F10SL-**-B-***	18,2	M4	3,2	5/8-24UNEF-2A	18,2	50	18,2	2,8	25,4	9,4	30	47
CA3100F12S-**-B-***	21,4	M4	3,2	5/8-24UNEF-2A	20,6	50	18,2	3,2	28,0	9,4	30	57
CA3100F14S-**-B-***	24,6	M4	3,2	3/4-20UNEF-2A	23,0	52	18,2	3,2	30,0	9,4	30	57
CA3100F16S-**-B-***	27,4	M4	3,2	7/8-20UNEF-2A	24,6	53	18,2	3,2	32,5	9,4	30	75
CA3100F16-**-B-***	27,4	M4	3,2	7/8-20UNEF-2A	24,6	60	21,5	3,2	32,5	9,4	30	85
CA3100F18-**-B-***	30,8	M4	3,2	1-20UNEF-2A	27,0	62	23,05	4,0	35,0	9,4	35	95
CA3100F20-**-B-***	34,2	M4	3,2	1 3/16-18UNEF-2A	29,4	66	23,05	4,0	38,0	9,4	35	115
CA3100F22-**-B-***	37,4	M4	3,2	1 3/16-18UNEF-2A	31,8	66	23,05	4,0	41,0	9,4	35	125
CA3100F24-**-B-***	40,9	M4	3,7	1 7/16-18UNEF-2A	34,9	69	23,05	4,0	44,5	9,4	40	160
CA3100F28-**-B-***	46,7	M5	3,7	1 7/16-18UNEF-2A	39,7	70	24,05	4,0	50,8	9,4	40	190
CA3100F32-**-B-***	53,4	M5	4,3	1 3/4-18UNS-2A	44,5	74	24,05	4,0	57,0	11,0	45	250
CA3100F36-**-B-***	59,6	M5	4,3	2-18UNS-2A	49,2	78	24,05	4,0	63,5	12,6	50	310

<sup>1)</sup> Weight without insulator, grommets and contacts.

Dimensions shown in mm

Specifications and dimensions subject to change

www.ittcannon.com



# Cannon VG/CA-Bayonet

## Wall Mounting Receptacles

CA3100R-B designates a wall mounting receptacle with short endbell without cable clamp.

CA3100R-B and Modifications, see page 12



Mod -05

Cannon Part no.	d <sub>1</sub> -0,15	d <sub>2</sub> Thread	H13	d <sub>3</sub> <sup>2)</sup> min.	d <sub>4</sub> max.	e ±0,1	l <sub>1</sub> max.	l <sub>2</sub> +0,4	l <sub>3</sub> ±0,2	l <sub>4</sub> ±0,3	Weight <sup>1)</sup> g max.
CA3100R10SL-**-B-***	18,2	M4	3,2	9,6	22,0	18,2	50	18,2	2,8	25,4	40
CA3100R12S-**-B-***	21,4	M4	3,2	10,3	23,0	20,6	52	18,2	3,2	28,0	50
CA3100R14S-**-B-***	24,6	M4	3,2	12,4	27,0	23,0	52	18,2	3,2	30,0	60
CA3100R16S-**-B-***	27,4	M4	3,2	15,4	28,0	24,6	58	18,2	3,2	32,5	70
CA3100R16-**-B-***	27,4	M4	3,2	15,4	28,0	24,6	58	21,5	3,2	32,5	75
CA3100R18-**-B-***	30,8	M4	3,2	18,4	31,0	27,0	65	23,05	4,0	35,0	90
CA3100R20-**-B-***	34,2	M4	3,2	22,0	35,0	29,4	65	23,05	4,0	38,0	110
CA3100R22-**-B-***	37,4	M4	3,2	24,7	38,0	31,8	65	23,05	4,0	41,0	125
CA3100R24-**-B-***	40,9	M4	3,7	27,6	42,0	34,9	67	23,05	4,0	44,5	160
CA3100R28-**-B-***	46,7	M5	3,7	31,6	49,0	39,7	67	24,05	4,0	50,8	190
CA3100R32-**-B-***	53,4	M5	4,3	38,5	55,0	44,5	67	24,05	4,0	57,0	230
CA3100R36-**-B-***	59,6	M5	4,3	44,5	62,0	49,2	67	24,05	4,0	63,5	300

<sup>1)</sup> Weight without insulator, grommets and contacts.

<sup>2)</sup> For max. cable entry.

## Straight Plug

CA3101F-B - designates a cable connection plug for flex tube

CA3101F-B and Modifications, see page 12

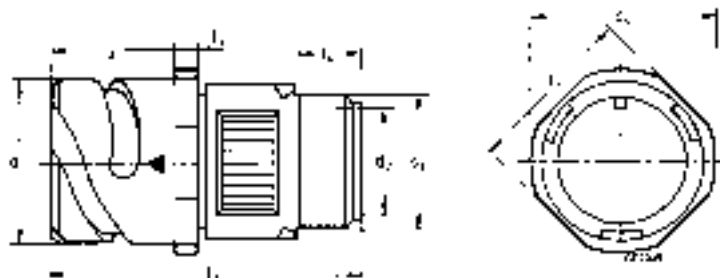

Cannon Part no.	d <sub>1</sub> -0,15	d <sub>2</sub> <sup>2)</sup> min.	d <sub>3</sub> Thread	d <sub>4</sub> max.	l <sub>1</sub> max.	l <sub>2</sub> +0,4	l <sub>3</sub> ±0,2	l <sub>4</sub> min.	l <sub>5</sub> ±0,2	Weight <sup>1)</sup> g max.
CA3101F10SL-**-B-***	18,2	8,2	5/8-24NEF-2A	25,2	52	18,2	2,8	9,5	20,6	35
CA3101F12S-**-B-***	21,4	8,2	5/8-24NEF-2A	27,8	52	18,2	3,2	9,5	23,6	45
CA3101F14S-**-B-***	24,6	11,1	3/4-20UNEF-2A	29,8	52	18,2	3,2	9,5	25,4	50
CA3101F16S-**-B-***	27,4	14,3	7/8-20UNEF-2A	32,3	59	18,2	3,2	9,5	28,6	60
CA3101F16-**-B-***	27,4	14,3	7/8-20UNEF-2A	32,3	59	21,5	3,2	9,5	28,6	65
CA3101F18-**-B-***	30,8	16,7	1-20UNEF-2A	34,8	63	23,05	4,0	9,5	31,7	80
CA3101F20-**-B-***	34,2	19,8	1 3/16-18UNEF-2A	37,8	63	23,05	4,0	9,5	34,9	95
CA3101F22-**-B-***	37,4	19,8	1 3/16-18UNEF-2A	41,1	66	23,05	4,0	9,5	38,1	105
CA3101F24-**-B-***	40,9	25,4	1 7/16-18UNEF-2A	44,6	69	23,05	4,0	9,5	41,3	140
CA3101F28-**-B-***	46,7	27,0	1 7/16-18UNEF-2A	50,9	70	24,05	4,0	9,5	47,6	160
CA3101F32-**-B-***	53,4	32,5	1 3/4-16UNS-2A	57,1	71	24,05	4,0	11,0	54,0	205
CA3101F36-**-B-***	59,6	35,7	2-18UNS-2A	63,6	73	24,05	4,0	11,8	60,6	270

<sup>1)</sup> Weight without insulator, grommets and contacts.

<sup>2)</sup> For max. cable entry.

# Cannon VG/CA-Bayonet

## Wall Mounting Receptacle

CA3100F-B designates a wall mounting receptacle with straight endbell and protective hose.

CA3100F-B and Modifications, see page 12

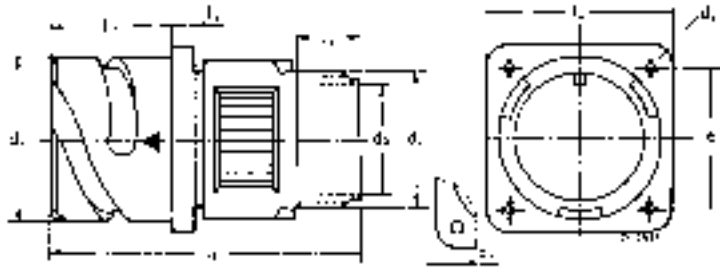

Mod -05

Cannon Part no.	d <sub>1</sub> -0,15	d <sub>2</sub> Thread	d <sub>2</sub> +0,2	d <sub>3</sub> <sup>2)</sup>	d <sub>4</sub> Thread	e ±0,1	l <sub>1</sub> max.	l <sub>2</sub> +0,4	l <sub>3</sub> ±0,2	l <sub>4</sub> ±0,3	l <sub>5</sub> min.	Weight <sup>1)</sup> g max.
CA3100F10SL-**-B-***	18,2	M4	3,2	8,2	5/8-24NEF-2A	18,2	52	18,2	2,8	25,4	9,5	40
CA3100F12S-**-B-***	21,4	M4	3,2	8,2	5/8-24NEF-2A	20,6	52	18,2	3,2	28,0	9,5	50
CA3100F14S-**-B-***	24,5	M4	3,2	11,1	3/4-20UNEF-2A	23,0	52	18,2	3,2	30,0	9,5	60
CA3100F16S-**-B-***	27,4	M4	3,2	14,3	7/8-20UNEF-2A	24,6	59	18,2	3,2	32,5	9,5	70
CA3100F16-**-B-***	27,4	M4	3,2	14,3	7/8-20UNEF-2A	24,6	59	21,5	3,2	32,5	9,5	75
CA3100F18-**-B-***	30,8	M4	3,2	16,7	1-20UNEF-2A	27,0	63	23,05	4,0	35,0	9,5	90
CA3100F20-**-B-***	34,2	M4	3,2	19,8	1 3/16-18UNEF-2A	29,4	63	23,05	4,0	38,0	9,5	110
CA3100F22-**-B-***	37,4	M4	3,2	19,8	1 3/16-18UNEF-2A	31,8	66	23,05	4,0	42,0	9,5	125
CA3100F24-**-B-***	40,9	M4	3,7	25,4	1 7/16-18UNEF-2A	34,9	69	23,05	4,0	44,5	9,5	160
CA3100F28-**-B-***	46,7	M5	3,7	27,0	1 7/16-18UNEF-2A	39,7	70	24,05	4,0	50,8	9,5	190
CA3100F32-**-B-***	53,4	M5	4,3	32,5	1 3/4-18UNS-2A	44,5	71	24,05	4,0	57,0	11,0	230
CA3100F36-**-B-***	59,6	M5	4,3	35,7	2-18UNS-2A	49,2	73	24,05	4,0	63,5	11,8	300

<sup>1)</sup> Weight without insulator, grommets and contacts.

<sup>2)</sup> For max. cable entry.

## Straight Plug

CA3101R-B designates a cable connection plug with short endbell, without cable clamp

CA3101R-B and Modification, see page 12

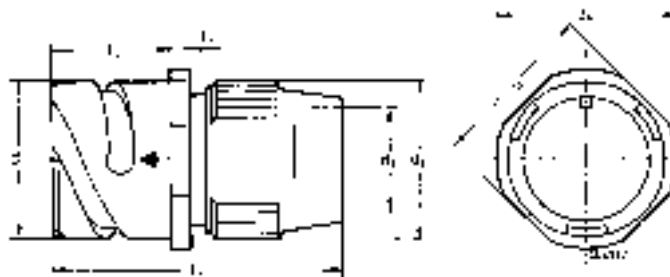

Cannon Part no.	d <sub>1</sub> -0,15	d <sub>2</sub> min.	d <sub>3</sub> max.	d <sub>4</sub> max.	l <sub>1</sub> max.	l <sub>2</sub> +0,4	l <sub>3</sub> ±0,2	l <sub>5</sub> ±0,2	Weight <sup>1)</sup> g max.
CA3101R10SL-**-B-***	18,2	9,6	22,0	25,2	50	18,2	2,8	20,6	32
CA3101R12S-**-B-***	21,4	10,3	23,0	27,8	52	18,2	3,2	23,6	40
CA3101R14S-**-B-***	24,6	12,4	27,0	29,8	52	18,2	3,2	25,4	47
CA3101R16S-**-B-***	27,4	15,4	28,0	32,3	58	18,2	3,2	28,6	55
CA3101R16-**-B-***	27,4	15,4	28,0	32,3	58	21,5	3,2	28,6	60
CA3101R18-**-B-***	30,8	18,4	31,0	34,8	65	23,05	4,0	31,7	75
CA3101R20-**-B-***	34,2	22,0	35,0	37,8	65	23,05	4,0	34,9	90
CA3101R22-**-B-***	37,4	24,7	38,0	41,1	65	23,05	4,0	38,1	100
CA3101R24-**-B-***	40,9	27,6	42,0	44,6	67	23,05	4,0	41,3	135
CA3101R28-**-B-***	46,7	31,6	49,0	50,9	67	24,05	4,0	47,6	155
CA3101R32-**-B-***	53,4	38,5	55,0	57,1	67	24,05	4,0	54,0	200
CA3101R36-**-B-***	59,6	44,5	62,0	63,6	67	24,05	4,0	60,6	260

<sup>1)</sup> Weight without insulator, grommets and contacts.

## Straight Plug

CA3106R-B designates a straight plug with short endbell, without cable clamp

CA3106R-B and Modification, see page 12

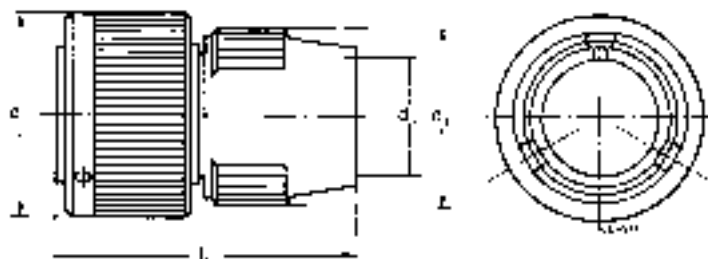

Cannon Part no.	d <sub>1</sub> max.	d <sub>2</sub> <sup>1)</sup>	d <sub>3</sub> max.	l <sub>1</sub> max.	Weight g max.
CA3106R10SL-**-B-***	22,8	9,6	22,0	50	27
CA3106R12S-**-B-***	26,0	10,3	23,0	50	35
CA3106R14S-**-B-***	29,2	12,4	27,0	50	40
CA3106R16S-**-B-***	32,0	15,4	28,0	50	50
CA3106R16-**-B-***	32,0	15,4	28,0	60	57
CA3106R18-**-B-***	36,5	18,4	31,0	62	65
CA3106R20-**-B-***	39,9	22,0	35,0	62	80
CA3106R22-**-B-***	43,1	24,7	38,0	62	87
CA3106R24-**-B-***	46,6	27,6	42,0	62	120
CA3106R28-**-B-***	53,4	31,6	49,0	62	150
CA3106R32-**-B-***	60,1	38,5	55,0	62	190
CA3106R36-**-B-***	66,3	44,5	62,0	62	250

<sup>1)</sup> For max. cable entry.

# Cannon VG/CA-Bayonet

## Jam Nut Receptacle

CA07A-B

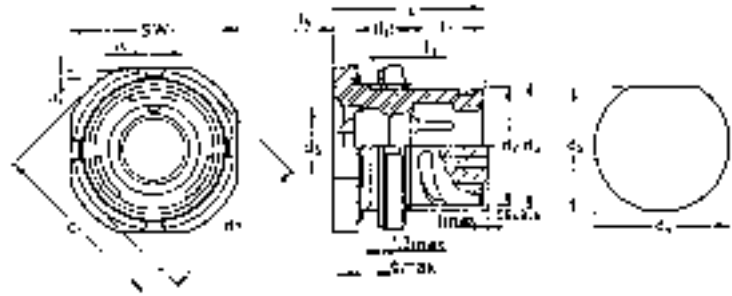

Cannon Part no.	d <sub>1</sub>	d <sub>2</sub>	d <sub>3</sub> Thread	(l <sub>1</sub> )	l <sub>2</sub>	l <sub>3</sub>	l <sub>4</sub>	d <sub>4</sub>	d <sub>5</sub>	d <sub>6</sub>	d <sub>7</sub>	sw	d <sub>8</sub>	l <sub>5</sub>	l <sub>6</sub>	l <sub>7</sub>
CA07A10SL-**-B-***	35,0	18,2	7/8-20UNEF-2A	13,5	12,5	4,0	29,2	22,7	20,9	13,5	31,5	31,8	20,6	3,2	5,0	2,5
CA07A14S-**-B-***	41,3	24,6	1 1/8-18UNEF-2A	13,5	12,5	4,0	29,2	28,8	27,2	17,9	37,9	38,1	26,9	3,2	6,0	2,5
CA07A16S-**-B-***	44,4	27,4	1 1/4-18UNEF-2A	13,5	12,5	4,0	29,2	32,0	30,4	21,1	41,0	41,2	30,1	3,2	6,0	2,5
CA07A16-**-B-***	44,4	27,4	1 1/4-18UNEF-2A	13,5	21,0	4,0	37,7	32,0	30,4	21,1	41,0	41,2	30,1	3,2	6,0	2,5
CA07A18-**-B-***	48,2	30,8	1 3/8-18UNEF-2A	15,0	21,0	5,0	40,0	35,1	33,6	24,2	44,8	45,0	33,3	4,0	7,0	3,0
CA07A20-**-B-***	52,4	34,2	1 1/2-18UNEF-2A	15,0	21,0	5,0	40,0	38,2	36,8	28,2	49,0	49,2	36,5	4,0	7,0	3,0
CA07A22-**-B-***	55,5	37,4	1 5/8-18UNEF-2A	15,0	21,0	5,0	40,0	42,0	39,9	31,4	52,2	52,4	39,6	4,0	7,0	3,0
CA07A24-**-B-***	59,0	40,9	1 3/4-18UNEF-2A	15,0	21,0	5,0	40,0	44,7	43,1	34,5	55,0	55,2	41,2	4,0	7,0	3,0
CA07A28-**-B-***	66,0	46,7	2-18UNEF-2A	15,0	21,0	5,0	40,0	51,1	49,2	40,1	62,0	62,2	47,5	4,0	7,0	3,0
CA07A32-**-B-***	72,0	53,4	2 1/4-16UN-2A	15,0	21,0	5,0	40,0	57,4	55,7	46,5	68,0	68,2	54,1	4,0	7,0	3,0
CA07A36-**-B-***	80,0	59,6	1/2-16UN-2A	15,0	21,0	5,0	40,0	63,8	62,0	51,2	75,0	75,2	60,5	4,0	8,0	3,0

## Straight Plug with PG Adapter

CA06PG-B

CA06GME-B

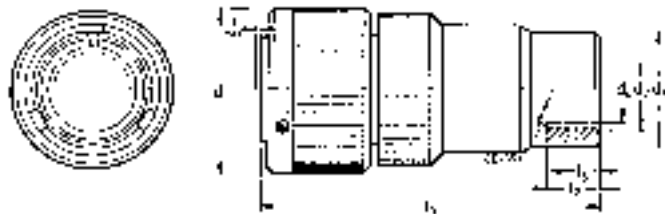

Cannon Part no.	d <sub>1</sub>	d <sub>3</sub>	d <sub>4</sub>	l <sub>1</sub>	l <sub>2</sub>	l <sub>3</sub>	d <sub>2</sub> PG-Thread
CA06PG10SL-**-B-***	22,8	18,0	9,7	52	9,5	7,0	PG 9
CA06PG12S-**-B-***	26,0	18,8	10,4	52	9,5	7,0	PG 9
CA06PG14S-**-B-***	29,2	22,0	12,5	52	10,0	7,0	PG11
CA06PG16S-**-B-***	32,0	23,6	15,0	54	10,0	7,0	PG13,5
CA06PG16-**-B-***	32,0	24,0	15,0	64	10,0	7,0	PG13,5
CA06PG18-**-B-***	36,5	24,4	17,0	69	11,5	7,5	PG13,5
CA06PG20-**-B-***	39,9	26,8	17,0	70	11,5	7,5	PG16
CA06PG22-**-B-***	42,1	26,4	17,0	73	11,5	7,5	PG16
CA06PG24-**-B-***	46,6	26,8	18,5	74	12,5	7,5	PG16
CA06PG28-**-B-***	53,4	32,0	18,5	74	12,5	7,5	PG21
CA06PG32-**-B-***	60,1	40,8	24,0	76	13,5	8,5	PG29
CA06PG36-**-B-***	66,3	40,8	32,0	87	15,0	9,0	PG29

Cannon Part no.	d <sub>1</sub>	d <sub>3</sub>	d <sub>4</sub>	l <sub>1</sub>	l <sub>2</sub>	l <sub>3</sub>	d <sub>2</sub> Metric
CA06ME10SL-**-B-***	22,8	18,0	9,7	52	9,5	7,0	M16 X 1,5
CA06ME12S-**-B-***	26,0	18,8	10,4	52	9,5	7,0	M16 X 1,5
CA06ME14S-**-B-***	29,2	22,0	12,5	52	10,0	7,0	M20 X 1,5
CA06ME16S-**-B-***	32,0	23,6	15,0	54	10,0	7,0	M20 X 1,5
CA06ME16-**-B-***	32,0	24,0	15,0	64	10,0	7,0	M20 X 1,5
CA06ME18-**-B-***	36,5	24,4	17,0	69	11,5	7,5	M25 X 1,5
CA06ME20-**-B-***	39,9	26,8	17,0	70	11,5	7,5	M25 X 1,5
CA06ME22-**-B-***	42,1	26,4	17,0	73	11,5	7,5	M32 X 1,5
CA06ME24-**-B-***	46,6	26,8	18,5	74	12,5	7,5	M32 X 1,5
CA06ME28-**-B-***	53,4	32,0	18,5	74	12,5	7,5	upon request
CA06ME32-**-B-***	60,1	40,8	24,0	76	13,5	8,5	upon request
CA06ME36-**-B-***	66,3	40,8	32,0	87	15,0	9,0	upon request

Dimensions shown in mm  
Specifications and dimensions subject to change

www.ittcannon.com



# Cannon VG/CA-Bayonet

## Coupling Dimensions

for connector style A, B1, B2, C1, C2, F, J1, J2, N1 and N2 resp. CA3100, CA3101, CA3102 and TBF

- A = Contact size 10
- B = Contact size 15S, 15, 16S, 16
- C = Contact size 25, 12
- D = Contact size 60, 100, 160, 500, 8.4, 0
- E = Contact size 10
- F = Contact size 15S, 16S
- G = all others

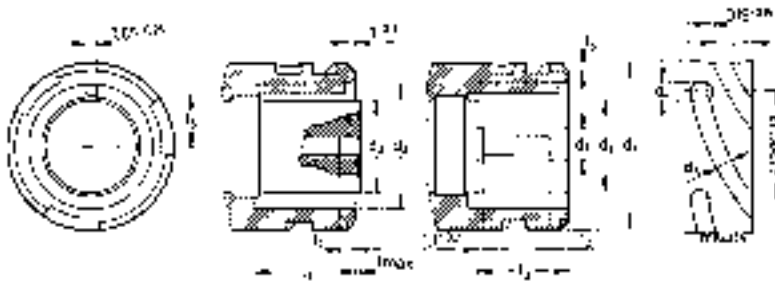

Shell size	d <sub>1</sub> -0,15	d <sub>2</sub> +0,3	d <sub>3</sub>	d <sub>4</sub> +0,4	d <sub>5</sub> +0,8	l <sub>1</sub> min.	l <sub>2</sub>				l <sub>3</sub> ±0,5	±1		l <sub>4</sub>	+0,2	l <sub>5</sub> +0,4	l <sub>6</sub> +0,1	l <sub>7</sub> -0,05
							A-1	B±1	C±1	D		E	F					
10SL	18,2	11,4	9,7 <sup>+0,25</sup> <sub>-0,3</sub>	2,75	2,75	14,2	-	2,2	-	-	12,8	-	2	-	1,8	4,4	6,3	
12S	21,4	14,2	10,8 <sup>+0,25</sup> <sub>-0,3</sub>	2,75	2,75	14,2	-	2,2	-	-	12,8	-	2	-	1,8	5,9	6,3	
14S	24,6	17,3	13,0 <sup>+0,25</sup> <sub>-0,3</sub>	2,75	2,75	14,2	-	2,2	-	-	12,8	-	2	-	1,8	6,9	6,3	
16S	27,4	20,6	16,1 <sup>+0,25</sup> <sub>-0,3</sub>	2,75	2,75	14,2	-	2,2	-	-	12,8	-	2	-	1,8	8,4	6,3	
16	27,4	20,6	16,1 <sup>+0,25</sup> <sub>-0,3</sub>	4,65	4,65	19	9,8	6,6	3	2,3	17,6	1,4	-	2,6	1,8	8,4	9,6	
18	30,8	23,8	18,8 <sup>±0,4</sup>	4,65	4,65	19	9,8	6,6	3	2,3	17,6	1,4	-	2,6	2,0	9,7	9,6	
20	34,2	26,9	22,6 <sup>±0,4</sup>	4,65	4,65	19	9,8	6,6	3	2,3	17,6	1,4	-	2,6	2,0	11,7	9,6	
22	37,4	30,0	25,1 <sup>±0,4</sup>	4,65	4,65	19	9,8	6,6	3	2,3	17,6	1,4	-	2,6	2,0	12,9	9,6	
24	40,9	33,2	28,2 <sup>±0,4</sup>	4,65	4,65	19	9,8	6,6	3	2,3	17,6	1,4	-	2,6	2,0	14,5	9,6	
28	46,7	38,8	33,6 <sup>±0,4</sup>	4,65	4,65	19	9,8	6,6	3	2,3	17,6	1,4	-	2,6	2,0	17,3	9,6	
32	53,4	45,2	40,0 <sup>±0,4</sup>	4,65	4,65	19	9,8	6,6	3	2,3	17,6	1,4	-	2,6	2,0	20,4	9,6	
36	59,6	50,6	45,5 <sup>±0,4</sup>	4,65	4,65	19	9,8	6,6	3	2,3	17,6	1,4	-	2,6	2,0	23,0	9,6	

## Coupling Dimensions

for connector style D, E, E1, G and H resp. CA3106 und 3108

- A = Contact size 10
- B = Contact size 15S, 15, 16S, 16
- C = Contact size 25, 12
- D = Contact size 60, 100, 160, 500, 8, 4, 0
- E = Contact size 10
- F = Contact size 15S, 16S
- G = all others

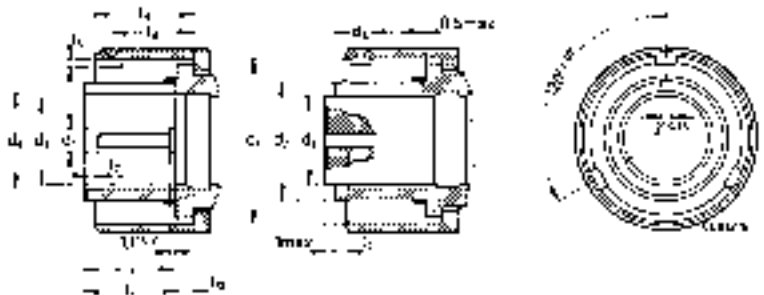

Shell size	d <sub>1</sub> -0,15	d <sub>2</sub> -0,3	d <sub>3</sub>	d <sub>4</sub> -0,1	d <sub>6</sub>	l <sub>1</sub> ±0,2	l <sub>2</sub>				l <sub>3</sub> <sup>1)</sup> ±0,5	±1		l <sub>4</sub>	l <sub>5</sub> +0,05 -0,1	l <sub>8</sub> ±1	l <sub>9</sub> ±0,5	l <sub>10</sub> +0,1 -0,05
							A	B	C	D		E	F					
10SL	18,2	11,3	9,7 <sup>+0,25</sup> <sub>-0,3</sub>	2,6	10,0 <sup>+0,3</sup>	13,5	-	2,2	-	-	12,8	-	2	-	1,6	11,8	14	2,1
12S	21,4	14,0	10,8 <sup>+0,25</sup> <sub>-0,3</sub>	2,6	11,4 <sup>+0,6</sup>	13,5	-	2,2	-	-	12,8	-	2	-	1,6	11,8	14	2,1
14S	24,8	17,1	13,0 <sup>+0,25</sup> <sub>-0,3</sub>	2,6	13,3 <sup>+0,6</sup>	13,5	-	2,2	-	-	12,8	-	2	-	1,6	11,8	14	2,1
16S	27,6	20,4	16,1 <sup>+0,25</sup> <sub>-0,3</sub>	2,6	16,4 <sup>+0,6</sup>	13,5	-	2,2	-	-	12,8	-	2	-	1,6	11,8	14	2,1
16	27,6	20,4	16,1 <sup>+0,25</sup> <sub>-0,3</sub>	4,5	16,4 <sup>+0,6</sup>	18,2	9,8	6,6	3	2,3	17,6	1,4	-	2,6	1,6	16,0	18,8	2,1
18	31,1	23,6	18,8 <sup>±0,4</sup>	4,5	19,6 <sup>+0,6</sup>	18,2	9,8	6,6	3	2,3	17,6	1,4	-	2,6	1,8	16,0	18,8	2,1
20	34,5	26,7	22,6 <sup>±0,4</sup>	4,5	23,6 <sup>+0,6</sup>	18,2	9,8	6,6	3	2,3	17,6	1,4	-	2,6	1,8	16,0	18,8	2,1
22	37,7	29,8	25,1 <sup>±0,4</sup>	4,5	26,0 <sup>+0,6</sup>	18,2	9,8	6,6	3	2,3	17,6	1,4	-	2,6	1,8	16,0	18,8	2,1
24	41,2	33,0	28,2 <sup>±0,4</sup>	4,5	29,1 <sup>+0,7</sup>	18,2	9,8	6,6	3	2,3	17,6	1,4	-	2,6	1,8	16,8	19,6	2,8
28	47,0	38,6	33,6 <sup>±0,4</sup>	4,5	34,7 <sup>+0,7</sup>	18,2	9,8	6,6	3	2,3	17,6	1,4	-	2,6	1,8	16,8	19,6	2,8
32	53,7	44,9	40,0 <sup>±0,4</sup>	4,5	41,0 <sup>+0,7</sup>	18,2	9,8	6,6	3	2,3	17,6	1,4	-	2,6	1,8	16,8	19,6	2,8
36	59,9	50,3	45,5 <sup>±0,4</sup>	4,5	46,6 <sup>+0,7</sup>	19	9,8	6,6	3	2,3	17,6	1,4	-	2,6	1,8	16,8	19,6	2,8

<sup>1)</sup> In terminated condition

# Cannon CA-Bayonet IP69K

---

## General Information

### Scope

This specification describes a similar CA-B connector with a sealing degree up to IP69K. This connector is interchangeable with the corresponding types as per MIL-C-5015 and VG95234, as they offer the same mounting dimensions and contact arrangements. These connectors are without spring washer, friction ring and grommet.

### Recommended Method of Mounting

Connector shell is fixed with 4 screws on the housing. In combination with unsiversal endbell and an o-ring between flange receptacle and wall the connector will reach IP68 sealing (1bar, 16h) and IP69K sealing.

## Ratings & Characteristics

Locking Device	Bayonet Coupling
Wire Size	From 1,5mm <sup>2</sup> to 2,5mm <sup>2</sup>
Contact Type	Crimp or Solder Contacts
Electric Characteristics	In accordance with VG95234 bayonet coupling
Environmental Characteristics	In accordance with VG95234 bayonet coupling Deviance with plating A240: 500h salt spray test with mated pair Deviance with plating A34: 48h salt spray test
Water tightness for mated connector	IP68 (1bar, 16h) and connector IP69K in combination with universal endbell and o-ring (flange receptacle to wall)

## Normative references

DIN EN 61984	(Electrical Connector, safety requirements and tests)
IEC 60068	(Environmental tests)
IEC 60352	(Crimp connection and requirements)
IEC 60512	(Electrical Connector, measuring and test procedure)
IEC 60529	(Specification for degrees of protection provided by enclosures)
VG 95373	(Electromagnetic compatibility)

# Cannon CA-Bayonet IP69K

## How to order

Cannon Order reference

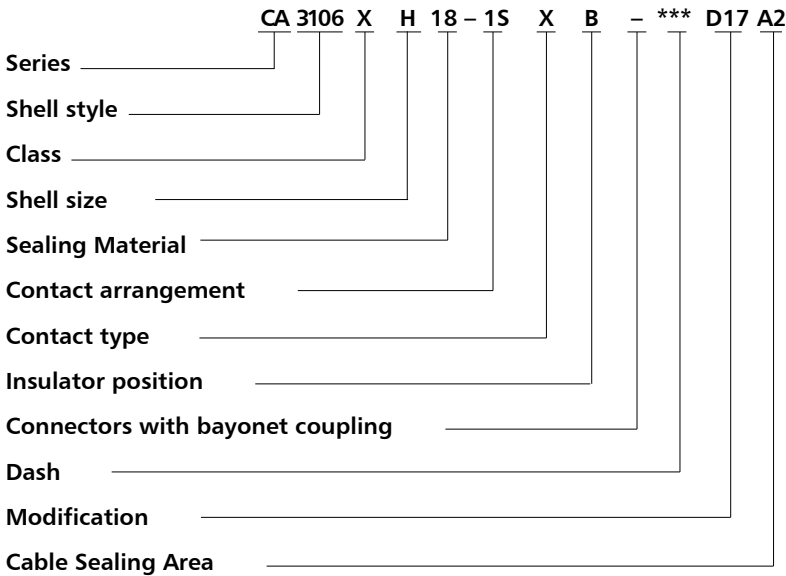

## Explanation

<b>Series</b>	CA
<b>Shell style</b>	02 = Wall mounting receptacle, front panel mounting 06 = Straight plug, without spring washer, friction ring and grommet
<b>Class</b>	X=Universal endbell IP69K
<b>Sealing Material</b>	H= FKM sealing Without = CR-Sealing / weak backed seal: Silicone (Standard)
<b>Shell Sizes</b>	Available shell sizes: 10SL, 14S, 18, 20, 22
<b>Contact Arrangement</b>	20-29 = Layout 20-29, 17x contact size 15/16
<b>Contact Type</b>	P= Pin, S=Socket
<b>Coupling Mechanism</b>	B=Bayonet
<b>Insulator Position</b>	See page 27
<b>Modification</b>	Please refer the Modification Codes on next page.
<b>Cable Sealing Area</b>	D07 = with Universal Endbell (IP69K), straight version: #10SL, #14S, #20 (wire size 4,5 - 7,2mm) D09 = with Universal Endbell (IP69K), straight version: #14S, #20 (wire size 6,5 - 9,3mm) D11 = with Universal Endbell (IP69K), straight version: #14S, #18, #20 (wire size 7,0 - 10,3mm) D13 = with Universal Endbell (IP69K), straight version: #18, #20, #22 (wire size 8,0 - 12,5mm) D14 = with Universal Endbell (IP69K), straight version: #18, #22 (wire size 11,1 - 14,2mm) D17 = with universal endbell, wire size 14,5mm - 16,6mm (wire size 14,5 - 16,6mm)





# Cannon CA-Bayonet IP69K

---

- Modification**
- 01 – metric crimp contacts
  - 41 – shielded version, grounding spring on barrel
  - F80 – AWG crimp contacts
  - A176 – gold plated contact, see pages 50-51
  - A232 – Zinc cobalt black plating
  - A233 – Zinc cobalt green plating
  - A240 – Zinc Nickel plating, blue iridescent
  - F0 – less contacts, contacts to be ordered separately, see pages 51– 52

# Cannon CA-Bayonet IP69K

## General

IP69K in combination with universal endbell and o-ring (flange receptacle to wall) other styles:

IP67 acc. To DIN 40050 (1 bar / 12 h)

**Attention!** Longitudinal sealing: The connector is not sealed against fluids entering through the cable, as the sealing lips of the single wire sealing are pressing against the jacket of the individual cables.

## Electrical Data (0,3 - 0,6 mm<sup>2</sup>)

### Insulation Resistance

Test acc. To VG95319 part 2, test no. 5.12., test condition B

Insulation resistance  $\geq 1000 \text{ M}\Omega$  (standard material)

### Test Voltage

Test acc. To VG95319 part 2, test no. 5.13.

Instruments: 1050 Vrms  
A: 1600 Vrms  
D: 2500 Vrms

Max. Permitted Operating Voltage	
DC voltage (U) in V	AC voltage (Urms) in V
85	60

### Operating Voltage and Connector Usage

Test acc. To VG95328 part 2, test no. 5.28.2.

If connector is used at voltage > 50 Vrms against ground general safety notes and protective measures acc. To DIN VDE part 410 and IEC 60364-4-41 have to be observed. All touchable parts have to be entered in these protective measures without fail. Connectors in equipments must not be separated or mated under load when used per specification.



## Current Rating

Current rating tested acc. To VG95234 part 1

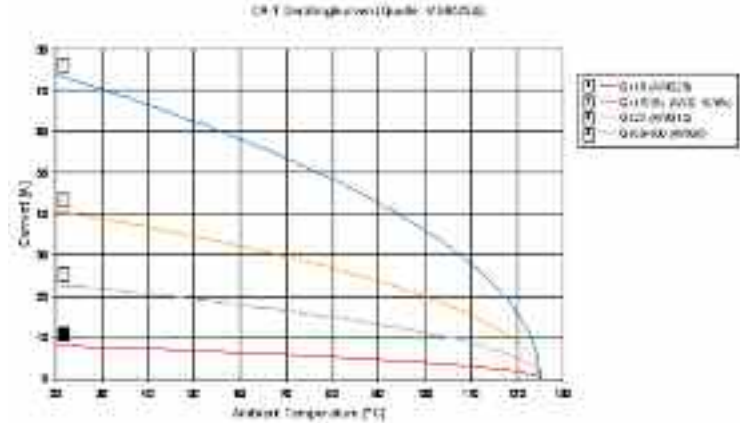

Current ratings are minimal values acc. To VG95234. For effective values refer to customer service.

## Contact Resistant

Milivolt test acc. To VG95234 part 2, test no. 5.10.1. and VG95210 part 37, including 100 mm of cable on each side.

Contact Size	Max. Contact Resistance
#10/20	12 m $\Omega$
#15/16	6 m $\Omega$
#25/12	3 m $\Omega$
#60/100/8	1 m $\Omega$

## Shielding

Test acc. To VG95234 part 1, test no. 5.11.

## Mechanical Characteristics

### Coupling Torque

	max	min
Coupling Torque at Opening and Closing	5 Nm	0,7 Nm

Designation	Material	Finish
Shell	Al-alloy	According to order reference
Coupling Nut		
Endbell		
Cone Ring		
Clamping Nut		
Clutch Spring	Spring Steel	-
Contact	Cu-alloy	Silver Plated and Passivated
Clutch Ring	PPS	-
Shielding Sleeve	PA66	
Clamping Ring	PBT	
Insulator	CR-rubber	-
Sealing Ring		
Grommet		
O-ring		

# Cannon CA-Bayonet IP69K

## Connector Dimensions

### Cable Connecting Plug Universal Endbell Bayonet

Endbell: Universal Endbell

Shielding: Yes

Sealing (\*): IP67, IP68, IP69K

CA01X...

Straight plug for cable connection with universal endbell.

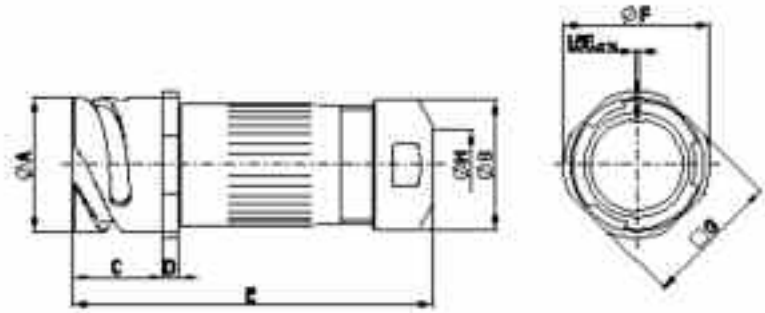

Please pay attention that the diameter of the cable is in the sealing range ØH.

Part No.	ØA	ØB	C	D	E	ØF	G	ØH Sealing Range			
								min	-	max	
	- 0,15	± 0,2	+ 0,4	± 0,2	max	max	± 0,2	min	-	max	
CA01X10SL-**-D07...	18.2	17.9	18.2	2.8	85	25.2	20.6	4.5	-	7.2	mm
CA01X14S-**-D07...	24.6	17.9	18.2	3.2	87	29.8	25.4	4.5	-	7.2	mm
CA01X14S-**-D09...	24.6	21.0	18.2	3.2	87	29.8	25.4	6.5	-	9.3	mm
CA01X14S-**-D11...	24.6	24.0	18.2	3.2	87	29.8	25.4	8.0	-	10.3	mm
CA01X18-**-D11...	30.8	24.0	23.05	4.0	93	34.8	31.7	8.0	-	10.3	mm
CA01X18-**-D13...	30.8	27.4	23.05	4.0	93	34.8	31.7	9.0	-	12.5	mm
CA01X18-**-D14...	30.8	30.0	23.05	4.0	93	34.8	31.7	11.5	-	14.2	mm
CA01X20-**-D07...	34.2	17.9	23.05	4.0	96	37.8	34.9	4.5	-	7.2	mm
CA01X20-**-D09...	34.2	21.0	23.05	4.0	96	37.8	34.9	6.5	-	9.3	mm
CA01X20-**-D11...	34.2	24.0	23.05	4.0	96	37.8	34.9	8.0	-	10.3	mm
CA01X20-**-D13...	34.2	27.4	23.05	4.0	96	37.8	34.9	9.0	-	12.5	mm
CA01X20-**-D17...	34.2	33.6	23.05	4.0	96	37.8	34.9	14.5	-	16.6	mm
CA01X22-**-D13...	37.4	27.4	23.05	4.0	100	41.1	38.1	9.0	-	12.5	mm
CA01X22-**-D14...	37.4	30.0	23.05	4.0	100	41.1	38.1	11.5	-	14.2	mm
CA01X22-**-D17...	37.4	33.6	23.05	4.0	100	41.1	38.1	14.5	-	16.6	mm
CA01X28-**-D17...	37.4	33.6	24.05	4.0	108	50.9	47.6	14.5	-	16.6	mm

(\* Sealing is achieved in mated condition. A receptacle with the suitable sealing grade is needed.

### Box Mounting Receptacle Front Panel Mounting

Endbell: None

Shielding: None

Sealing (\*): IP67, IP68, IP69K

CA02X...-B...

Box Mounting Receptacle

Front Panel Mounting

with O-Ring Sealing for IP69K

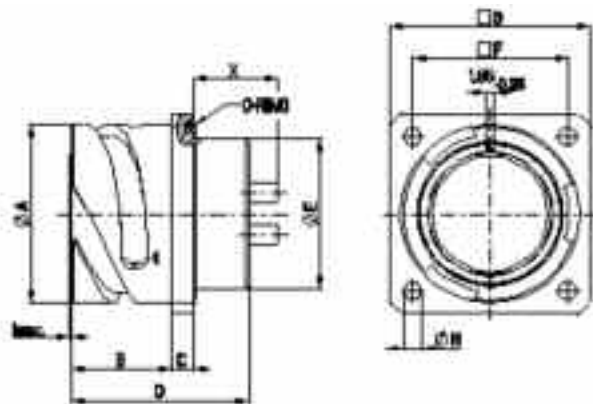

Part No.	A	B	C	D	E	F	G	H	X / Kontaktgröße		
									15	25	100
	- 0,15	+ 0,4	± 0,2	± 0,3	max	± 0,1	± 0,3	H13	15	25	100
CA02X10SL-**-P*-B	18.2	14.2	2.8	24.7	16.2	18.2	25.4	3.2	13.6	-	-
CA02X14S-**-P*-B	24.6	14.2	3.2	24.7	19.2	23	30	3.2	13.2	-	-
CA02X18-**-P*-B	30.8	19.0	4.0	33.8	25.6	27.0	35.0	3.2	17.1	17.1	18.7
CA02X20-**-P*-B	34.2	19.0	4.0	33.8	29.0	29.4	38.0	3.2	17.1	17.1	18.7
CA02X22-**-P*-B	37.4	19	4.0	33.8	32.2	31.8	41	3.2	17.1	17.1	18.7
CA02X28-**-P*-B	46.7	20.6	4.0	33.8	41.4	39.7	50.8	3.7	15.5	15.5	17.1

(\* Sealing is achieved in mated condition.

Dimensions shown in mm

Specifications and dimensions subject to change

www.ittcannon.com

# Cannon CA-Bayonet IP69K

## Straight Plug Universal Endbell Bayonet

Endbell: Universal Endbell

Shielding: Yes, with Modification Code

Sealing (\*): IP67, IP68, IP69K

CA06X...-B...

Straight plug with universal endbell.

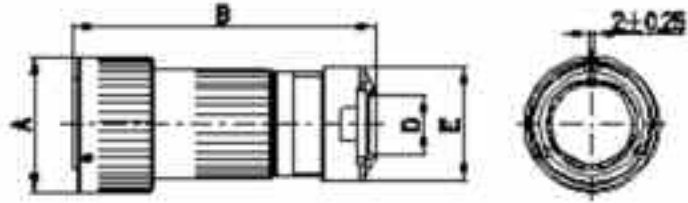

Please pay attention that the diameter of the cable is in the sealing range ØH.

Part No.	ØA	B	ØE	ØD Sealing Range			
				min		max	
CA06X10SL-**-**...D07...	22.8	82	17.9	4.5	-	7.2	mm
CA06X14S-**-**...D07...	29.2	82	17.9	4.5	-	7.2	mm
CA06X14S-**-**...D09...	29.2	82	21.0	6.5	-	9.3	mm
CA06X14S-**-**...D11...	29.2	82	24.0	8.0	-	10.3	mm
CA06X18-**-**...D11...	36.5	88	24.0	8.0	-	10.3	mm
CA06X18-**-**...D13...	36.5	88	27.4	9.0	-	12.5	mm
CA06X18-**-**...D14...	36.5	88	30.0	11.5	-	14.2	mm
CA06X20-**-**...D07...	39.9	92	17.9	4.5	-	7.2	mm
CA06X20-**-**...D09...	39.9	92	21.0	6.5	-	9.3	mm
CA06X20-**-**...D11...	39.9	92	24.0	8.0	-	10.3	mm
CA06X20-**-**...D13...	39.9	92	27.4	9.0	-	12.5	mm
CA06X20-**-**...D17...	39.9	92	33.6	14.5	-	16.6	mm
CA06X22-**-**...D13...	43.1	98	27.4	9.0	-	12.5	mm
CA06X22-**-**...D14...	43.1	98	30.0	11.5	-	14.2	mm
CA06X22-**-**...D17...	43.1	98	33.6	14.5	-	16.6	mm
CA06X28-**-**...D17...	53.4	105	33.6	14.5	-	16.6	mm

## Mating Dimensions

for shell styles K, L and M, shown without coupling nut

Size	d <sub>8</sub> min.	Size	d <sub>8</sub> min.
14S	17,9	22	30,7
16S	21,2	24	33,9
16	21,2	28	39,5
18	24,4	32	46,0
20	27,6	36	51,4

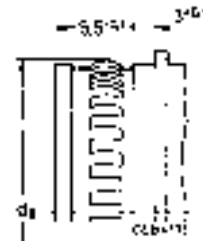

# Cannon VG/CA-Bayonet

## Plastic Protecting Caps



Colour: red  
(similar to RAL 2003)

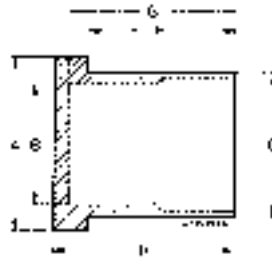

Part no.	Protecting cap for		ø A max.	ø B -0,2	ø D +0,2	F ±0,2	G ±0,2	H max.
	Receptacles Shell size	Plugs Shell size						
025-8636-005	10S/10SL	-	22,8	17,7	19,7	10,7	14,2	15,9
025-8636-006	-	10S/10SL	22,8	10,7	12,9	15,5	17,0	18,7
025-8636-008	-	12S	26,0	13,4	15,8	15,5	17,0	18,7
025-8636-010	12S/12	-	26,0	20,9	22,9	10,7	14,2	15,9
025-8636-016	14S/14	-	29,2	24,1	26,1	10,7	14,2	15,9
025-8636-017	-	14S	29,2	16,5	19,1	15,5	17,0	18,7
025-8636-018	-	14	29,2	16,5	19,1	20,2	21,7	23,4
025-8636-022	-	16S	32,0	19,8	22,4	15,5	17,0	18,7
025-8636-024	-	16	32,0	19,8	22,4	20,2	21,7	23,4
025-8636-025	16S	-	32,0	26,9	28,9	10,7	14,2	15,9
025-8636-026	16	-	32,0	26,9	28,9	17,5	19,0	20,7
025-8636-034	18	-	36,5	30,3	32,3	17,5	19,0	20,7
025-8636-036	-	18	36,5	23,0	25,6	20,2	21,7	23,4
025-8636-042	20	-	39,9	33,7	35,7	17,5	19,0	20,7
025-8636-044	-	20	39,9	26,1	28,8	20,2	21,7	23,4
025-8636-048	-	22	43,1	29,2	31,9	20,2	21,7	23,4
025-8636-049	22	-	43,1	36,9	38,9	17,5	19,0	20,7
025-8636-053	24	-	46,6	40,4	42,4	19,1	20,6	22,3
025-8636-054	-	24	46,6	32,4	35,1	20,2	21,7	23,4
025-8636-058	28	-	53,4	46,2	48,2	19,1	20,6	22,3
025-8636-060	-	28	53,4	38,0	40,7	20,2	21,7	23,4
025-8636-061	-	32	60,1	44,3	47,2	20,2	21,7	23,4
025-8636-062	32	-	64,9	52,9	54,9	20,7	22,2	23,9
025-8636-064	36	-	71,1	59,1	60,1	20,7	22,2	23,9
025-8636-065	-	36	66,3	49,7	51,6	20,2	21,7	23,4

# Cannon VG/CA-Bayonet

## Metal Protecting Caps

for receptacles, shell style  
3100, 3101 und 3102  
Material: Aluminum alloy

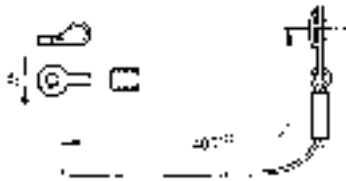

VG95234 Style KA with cord



VG95234 Style KR with chain

Shell size	VG95234 Part No. with chain	Cannon A65 Part No. with chain	Cannon A232 Part No. with chain	Cannon A233 Part No. with chain	Cannon A240 Part No. with chain	VG95234 Part No. with cord	Cannon A66 Part No. with chain	d <sub>1</sub> max.	d <sub>2</sub> +0,6	l <sub>1</sub> min.	l <sub>2</sub> max. for chain	Weight g max.
10SL	VG95234KR10SL	CA121003-1	CA121003-71	CA121003-121	CA121003-161	VG95234KA10SL	CAB81-10SL-D	23,5	4,3	100	20	16
12S		CA121003-2	CA121003-72	CA121003-122	CA121003-162		CAB81-12S-D	27	4,3	100	20	17
14S	VG95234KR14S	CA121003-3	CA121003-73	CA121003-123	CA121003-163	VG95234KA14S	CAB81-14S-D	30,6	4,3	100	20	18
16S	VG95234KR16S	CA121003-4	CA121003-74	CA121003-124	CA121003-164	VG95234KA16S	CAB81-16S-D	33	4,3	100	20	16
16	VG95234KR16	CA121003-5	CA121003-75	CA121003-125	CA121003-165	VG95234KA16	CAB81-16-D	33	4,3	113	25	23
18	VG95234KR18	CA121003-6	CA121003-76	CA121003-126	CA121003-166	VG95234KA18	CAB81-18-D	37,5	4,3	113	25	27
20	VG95234KR20	CA121003-7	CA121003-77	CA121003-127	CA121003-167	VG95234KA20	CAB81-20-D	41	4,3	127	25	30
22	VG95234KR22	CA121003-8	CA121003-78	CA121003-128	CA121003-168	VG95234KA22	CAB81-22-D	44	4,3	127	25	33
24	VG95234KR24	CA121003-9	CA121003-79	CA121003-129	CA121003-169	VG95234KA24	CAB81-24-D	47,5	4,3	127	25	37
28	VG95234KR28	CA121003-10	CA121003-80	CA121003-130	CA121003-170	VG95234KA28	CAB81-28-D	54,5	5,5	169	25	42
32	VG95234KR32	CA121003-11	CA121003-81	CA121003-131	CA121003-171	VG95234KA32	CAB81-32-D	61	5,5	169	25	48
38	VG95234KR38	CA121003-12	CA121003-82	CA121003-132	CA121003-172	VG95234KA36	CAB81-36-D	67,5	5,5	169	25	55

For plating information A66, A232, A233, A240. Please see page 48

If on CAB 81 another plating is desired please add the relevantMod as indicated on page 48

## Metal Protecting Caps

for plugs, shell style  
3106 and 3108  
Material: Aluminum alloy

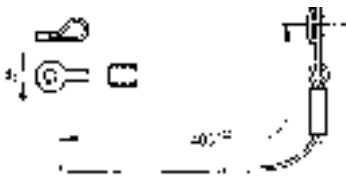

VG95234 Style KC with cord

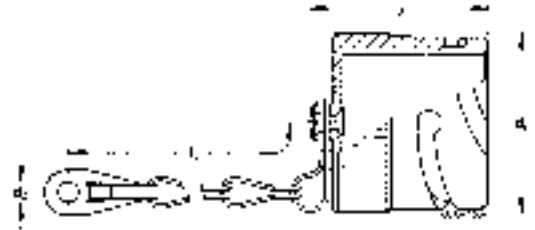

VG95234 Style KB with chain

Shell size	VG95234 Part No. with chain	Cannon A65 Part No. with chain	Cannon A232 Part No. with chain	Cannon A233 Part No. with chain	Cannon A240 Part No. with chain	VG95234 Part No. with cord	Cannon A66 Part No. with chain	d <sub>1</sub> max.	d <sub>2</sub> +0,6	l <sub>1</sub> min.	l <sub>2</sub> max. for chain	Weight g max.
10SL	VG95234KB10SL	CA121004-1	CA121004-71	CA121004-121	CA121004-161	VG95234KC10SL	CAB80-10SL-D	21	4,3	100	29	19
12S		CA121004-2	CA121004-72	CA121004-122	CA121004-162		CAB80-12S-D	24	4,3	100	29	23
14S	VG95234KB14S	CA121004-3	CA121004-73	CA121004-123	CA121004-163	VG95234KC14S	CAB80-14S-D	27,5	4,3	100	29	26
16S	VG95234KB16S	CA121004-4	CA121004-74	CA121004-124	CA121004-164	VG95234KC16S	CAB80-16S-D	30	4,3	100	29	28
16	VG95234KB16	CA121004-5	CA121004-75	CA121004-125	CA121004-165	VG95234KC16	CAB80-16-D	30	4,3	113	37	33
18	VG95234KB18	CA121004-6	CA121004-76	CA121004-126	CA121004-166	VG95234KC18	CAB80-18-D	33,5	4,3	113	37	38
20	VG95234KB20	CA121004-7	CA121004-77	CA121004-127	CA121004-167	VG95234KC20	CAB80-20-D	34	4,3	127	37	43
22	VG95234KB22	CA121004-8	CA121004-78	CA121004-128	CA121004-168	VG95234KC22	CAB80-22-D	40	4,3	127	37	47
24	VG95234KB24	CA121004-9	CA121004-79	CA121004-129	CA121004-169	VG95234KC24	CAB80-24-D	43,5	4,3	127	37	53
28	VG95234KB28	CA121004-10	CA121004-80	CA121004-130	CA121004-170	VG95234KC28	CAB80-28-D	49,5	5,5	169	37	63
32	VG95234KB32	CA121004-11	CA121004-81	CA121004-131	CA121004-171	VG95234KC32	CAB80-32-D	56	5,5	169	37	75
38	VG95234KB38	CA121004-12	CA121004-82	CA121004-132	CA121004-172	VG95234KC36	CAB80-36-D	62,5	5,5	169	37	88

For plating information A66, A232, A233, A240. Please see page 48

If on CAB 80 another plating is desired please add the relevantMod as indicated on page 48

# Accessories

## Dummy Receptacles

Front panel mounting (rear side open)

VG95234 Style BOD (Flange with through-holes)  
CA3105-B

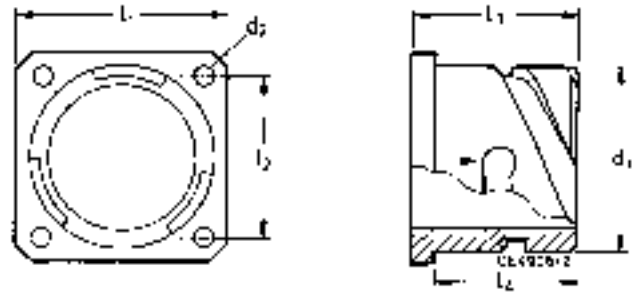

Shell size	VG95234 Part no.	Cannon Part no.	d <sub>1</sub> -0,15	d <sub>2</sub> ±0,2	l <sub>1</sub> ±0,3	l <sub>2</sub> ±0,1	l <sub>3</sub> max.	l <sub>4</sub> +0,3
10SL	VG95234BOD10SL	CA3105E10SL-B	18,2	3,2	25,4	18,2	17,5	14,2
12S	-	CA3105E12S-B	21,4	3,2	28,0	20,6	18,0	14,2
14S	VG95234BOD14S	CA3105E14S-B	24,6	3,2	30,0	23,0	18,0	14,2
16S	VG95234BOD16S	CA3105E16S-B	27,4	3,2	32,5	24,6	18,0	14,2
16	VG95234BOD16	CA3105E16-B	27,4	3,2	32,5	24,6	23,5	19,0
18	VG95234BOD18	CA3105E18-B	30,8	3,2	35,0	27,0	23,5	19,0
20	VG95234BOD20	CA3105E20-B	34,2	3,2	38,0	29,4	23,5	19,0
22	VG95234BOD22	CA3105E22-B	37,4	3,2	41,0	31,8	23,5	19,0
24	VG95234BOD24	CA3105E24-B	40,9	3,7	44,5	34,9	25,5	20,6
28	VG95234BOD28	CA3105E28-B	46,7	3,7	50,8	39,7	25,5	20,6
32	VG95234BOD32	CA3105E32-B	53,4	4,3	57,0	44,5	27,0	22,2
36	VG95234BOD36	CA3105E36-B	59,6	4,3	63,5	49,2	27,0	22,2

## Dummy Receptacles

Rear panel mounting (rear side closed)

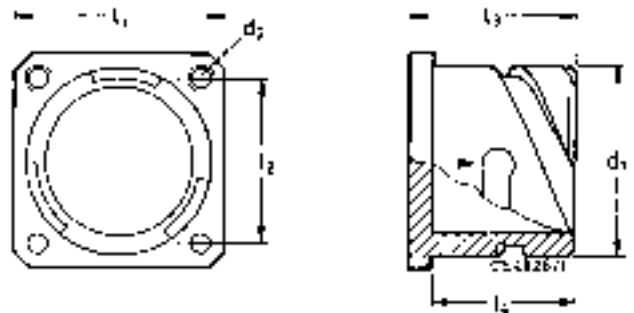

Shell size	CA3105E-B Cannon Part no. with thread Style A	CA3105E-B-05 Cannon Part no. with through holes Style B	d <sub>1</sub>	l <sub>1</sub> ±0,25	l <sub>2</sub> ±0,3	l <sub>3</sub>	l <sub>4</sub> +0,3	Style A d <sub>2</sub>	Style B d <sub>2</sub> ±0,2
10SL	248-8513-000	248-8501-000	18,2	25,4	18,2	21,1	18,3	M4	3,2
12S	248-8514-000	248-8502-000	21,4	28,0	20,6	21,5	18,3	M4	3,2
14S	248-8515-000	248-8503-000	24,6	30,0	23,0	21,5	18,3	M4	3,2
16S	248-8516-000	248-8504-000	27,4	32,5	24,6	21,5	18,3	M4	3,2
16	248-8517-000	248-8505-000	27,4	32,5	24,6	24,8	21,6	M4	3,2
18	248-8518-000	248-8506-000	30,8	35,0	27,0	27,2	23,15	M4	3,2
20s	248-8519-000	248-8507-000	34,2	38,0	29,4	27,2	23,15	M4	3,2
22	248-8520-000	248-8508-000	37,4	41,0	31,8	27,2	23,15	M4	3,2
24	248-8521-000	248-8509-000	40,9	44,5	34,9	27,2	23,15	M4	3,7
28	248-8522-000	248-8510-000	46,7	50,8	39,7	28,2	24,15	M5	3,7
32	248-8523-000	248-8511-000	53,4	57,0	44,5	28,2	24,15	M5	4,4
36	248-8524-000	248-8512-000	59,6	63,5	49,2	28,2	24,15	M5	4,4

Dimensions shown in mm

Specifications and dimensions subject to change

www.ittcannon.com

# Accessories

## Sealing Rings

for use on the barrel of the plug

Size	Part no.	$d_9$
10SL	980-8550-000	9,0
12S	980-8551-000	11,5
14S	980-8552-000	14,0
16/16S	980-8553-000	17,0
18	980-8554-000	19,5
20	980-8555-000	22,5
22	980-8556-000	25,4
24	980-8557-000	28,5
28	980-8558-000	34,0
32	980-8559-000	40,0
36	980-8560-000	45,0

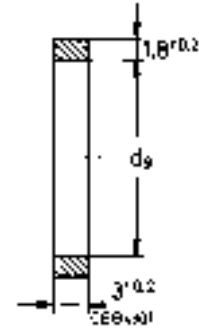

## Wire Hole Fillers

Are needed in case of none occupied contacts. Contacts have to be installed while the wire hole fillers are mounted into the relevant open grommet holes.

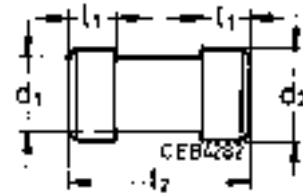

Size	VG95234 Part no.	For contact size metr.	AWG	$d_1$ $\pm 0,1$	$d_2$ $\pm 0,2$	$l_1$ $\pm 0,1$	$l_2$ $\pm 0,3$	Colour	Part no.
20	VG95234B20	10		2,3	3,0	2,4	9,7	red	225-1000-000
16S	VG95234B16S	15S	16S	2,8	3,7	1,5	4,8	nature	225-8510-000
16	VG95234B16	15S/15	16S/16	2,8	3,7	3,2	11,9	blue	225-0017-000
12	VG95234B12	25/25A	12	3,7	4,6	3,2	11,9	yellow	225-0018-000
8	VG95234B08	60/100	8	5	5,8	3,2	11,9	white	225-0019-000
4	VG95234B04	160	4	7,6	8,5	3,2	11,9	green	225-8502-000
0	VG95234B00	500	0	12,8	13,5	3,2	11,9	black	225-8503-000



# Accessories

## Cable Clamps

without telescoping bushing

VG95234 Style KK

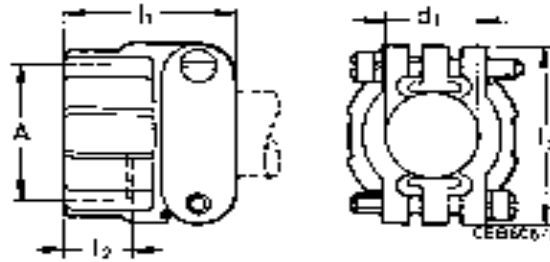

VG95234 Part no.	Former Designation MS	Shell size suitable for connectors acc. MS	A-Thread	l <sub>2</sub> max.	d <sub>1</sub> max.	l <sub>1</sub> max.	l <sub>3</sub> max.	Shell-Weight g
VG95234KK 4	MS3057- 4A*	10SL, 12S,	5/7-24NEF-2B	10,5	7,9	20,8	22,5	13,2
VG95234KK 6	MS3057- 6A*	14S,	3/4-20UNEF-2B	10,5	11,1	22,4	27,4	18,6
VG95234KK 8	MS3057- 8A*	16S, 16	7/8-20UNEF-2B	10,5	14,2	24,0	29,8	23,6
VG95234KK12	MS3057-10A*	18	1-20UNEF-2B	10,5	15,8	24,0	32,2	27,3
VG95234KK12	MS3057-12A*	20, 22	1 3/16-18NEF-2B	10,5	19,0	24,0	37,4	37,2
VG95234KK16	MS3057-16A*	24, 28	1 7/16-18NEF-2B	10,5	23,7	26,4	43,5	56,3
VG95234KK20	MS3057-20A*	32	1 3/4-18NS-2B	12,0	31,8	28,0	51,7	83,9
VG95234KK24	MS3057-24A*	36	2-18NS-2B	13,7	34,6	29,6	57,8	109,8

\* WB = Cable clamp with cable telescoping bushing

## Telescoping Bushings

Telescoping bushing (used with MS3057A resp. VG95234KK cable clamp) keep dirt, oil and dust out of endbell. Taping or wrapping wires is eliminated since bushing protects wires guided through clamp. Combinations of two bushings may be used to decrease inner diameter for improved sealing.

Material: Polychloroprene

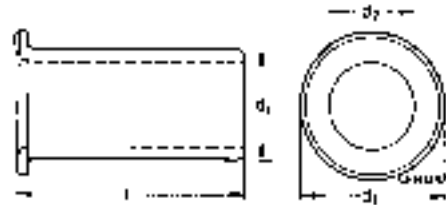

Shell size	VG95234 Part no.	MS Part no.	Cannon Part no.	d <sub>1</sub>	d <sub>2</sub>	d <sub>3</sub>	l	Weight g
10SL, 12S	VG95234KT10SL	MS3420-04	012-8552-000	8,0	6,6	9,9	70,0	4
14S	VG95234KT14S	MS3420-06	012-8554-000	10,9	9,1	12,7	67,0	5
16S, 16	VG95234KT16	MS3420-08	012-0218-000	14,0	11,1	19,0	64,0	6
18	VG95234KT18	MS3420-10	012-0219-000	15,7	14,3	22,0	60,0	4
20, 22	VG95234KT20	MS3420-12	012-0220-000	18,8	15,9	26,9	57,0	7
24	VG95234KT24	MS3420-16	012-8555-000	21,2	16,6	26,9	57,0	13
28	VG95234KT28	MS3420-18	012-8556-000	23,6	21,5	33,3	54,0	13
32	VG95234KT32	MS3420-20	012-8557-000	26,5	21,5	33,3	54,0	26
	-	-	012-8558-000	31,5	26,8	40,4	51,0	26
36	VG95234KT32	MS3420-24	012-8558-000	31,5	26,8	40,4	51,0	30
	-	MS3420-24	012-0223-000	34,7	31,8	46,8	48,0	30

Dimensions shown in mm

Specifications and dimensions subject to change

www.ittcannon.com



# Accessories

## Gaskets

Thickness of gaskets  
 made of Alu-Flex "2" = 0,5 mm  
 made of Polychloropren "1" = 1,0 mm

VG95234 Style DA for front panel mounting  
 VG95234 Style DH for front panel mounting

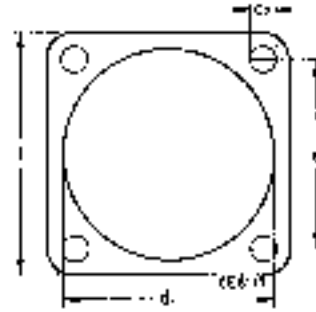

### For front panel mounting

Size	VG95234 Part no.	Part no. Version Polychloropen <sup>1</sup>	Part no. Version Alu-Flex <sup>2</sup>	l ±0,5	e ±0,2	d <sub>1</sub> +1 front panel	d <sub>2</sub> +0,5	Weight g max.
10SL	VG95234 DA 10SL-X	075-8512-000	075-8512-001	25,4	18,2	15,7	4,2	2
12S		075-8513-000	075-8513-001	28,0	20,6	18,9	4,2	2
14S	VG95234 DA 14S-X	075-8514-000	075-8514-001	30,0	23,0	22,1	4,2	2
16/16S	VG95234 DA 16X	075-8515-000	075-8515-001	32,5	24,6	25,3	4,2	2
18	VG95234 DA 18-X	075-8516-000	075-8516-001	35,0	27,0	28,4	4,2	2
20	VG95234 DA 20-X	075-8517-000	075-8517-001	38,0	29,4	31,6	4,2	2
22	VG95234 DA 22-X	075-8518-000	075-8518-001	41,0	31,8	34,8	4,2	2
24	VG95234 DA 24-X	075-8519-000	075-8519-001	44,5	34,9	38,0	4,2	2
28	VG95234 DA 28-X	075-8520-000	075-8520-001	50,8	39,7	44,3	5,1	2
32	VG95234 DA 32-X	075-8521-000	075-8521-001	57,0	44,5	50,7	5,1	2
36	VG95234 DA 36-X	075-8522-000	075-8522-001	63,5	49,2	57,0	5,1	2

### For rear panel mounting

Size	VG95234 Part no.	Part no. Version Polychloropen <sup>1</sup>	Part no. Version Alu-Flex <sup>2</sup>	l ±0,5	e ±0,2	d <sub>1</sub> +1 front panel	d <sub>2</sub> +0,5	Weight g max.
10SL	VG95234 DH 10SL-X	075-8501-000	075-8501-001	25,4	18,2	18,2	4,2	2
12S		075-8502-000	075-8502-001	28,0	20,6	21,4	4,2	2
14S	VG95234 DH 14S-X	075-8503-000	075-8503-001	30,0	23,0	24,6	4,2	2
16/16S	VG95234 DH 16X	075-8504-000	075-8504-001	32,5	24,6	27,4	4,2	2
18	VG95234 DH 18-X	075-8505-000	075-8505-001	35,0	27,0	30,8	4,2	2
20	VG95234 DH 20-X	075-8506-000	075-8506-001	38,0	29,4	34,2	4,2	2
22	VG95234 DH 22-X	075-8507-000	075-8507-001	41,0	31,8	37,4	4,2	2
24	VG95234 DH 24-X	075-8508-000	075-8508-001	44,5	34,9	40,9	4,2	2
28	VG95234 DH 28-X	075-8509-000	075-8509-001	50,8	39,7	46,7	5,1	2
32	VG95234 DH 32-X	075-8510-000	075-8510-001	57,0	44,5	53,4	5,1	2
36	VG95234 DH 36-X	075-8511-000	075-8511-001	63,5	49,2	59,6	5,1	2

X = insert "1" (electrically not conductive) or "2" (electrically conductive)

# Contacts

## Contacts

Standard contacts and contacts with reduced termination diameter

### Pin contacts

Size 15S/16S, 15/16, 25/12, 60/100/8, 160/4, 500/0

Size 10/20

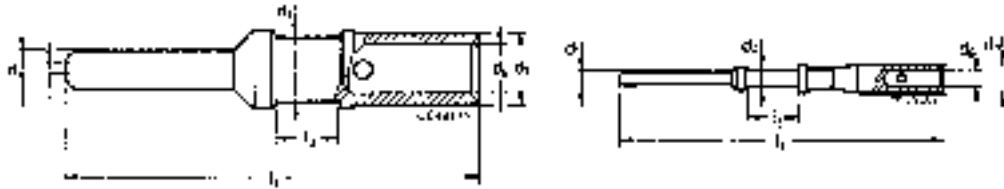

### Finish

A36 – 5 µm silver plated and passivated

A176 – 2 µm nickel plated, min. 0,5 µm gold plated

Contact size	VG95234 Part no.	Wire size mm <sup>2</sup>	AWG	Part no. with finish Standard: A36 silver plated	Part no. with finish Mod.Code: A176 gold plated	d <sub>1</sub> -0,05	d <sub>4</sub>	d <sub>6</sub>	d <sub>7</sub>	l <sub>1</sub> ±0,15	l <sub>3</sub> ±0,5	Color Code
10/20	VG95234P10	0,5-1,0	20/18	030-8585-000	030-8585-006	1,04	1,5	1,5	2,4	28,4	4,75	–
	VG95234P10-001	0,2-0,4	26/22	030-8585-010	–	1,04	1,5	0,9	2,4	28,4	4,75	blue
15S/16S	VG95234P15S	0,75-1,5	18/16	030-8586-000	030-8586-006	1,6	1,75	1,75	2,75	27,4	3,85	–
	VG95234P15S-002	0,3-0,6	22/20	330-8744-000	330-8744-006	1,6	1,75	1,2	2,75	27,4	3,85	red
	VG95234P15S-001	0,14-0,38	22/26	030-8586-010	–	1,6	1,75	0,9	2,75	27,4	3,85	blue
15/16	VG95234P15	0,75-1,5	18/16	030-8587-000	030-8587-006	1,6	1,75	1,75	2,75	31,4	7,9	–
	VG95234P15-002	0,3-0,6	22/20	330-8659-000	330-8659-006	1,6	1,75	1,2	2,75	31,4	7,9	red
	VG95234P15-001	0,14-0,38	22/26	030-8587-030	030-8587-036	1,6	1,75	0,9	2,75	31,4	7,9	blue
25/12	VG95234P25	2,0-3,0	14/12	030-8588-000	030-8588-006	2,4	3,3	2,5	3,8	37,0	7,9	–
	VG95234P25-001	0,75-1,5	18/16	030-8588-010	030-8588-016	2,4	3,3	1,75	3,4	37,0	7,9	black
		4,0	–	030-8588-054	–	2,4	3,3	2,8	3,8	37,0	7,9	–
60/100/8	VG95234P8	–	8	030-8612-000	030-8612-006	3,6	6,25	4,55	6,8	39,6	6,35	–
	VG95234P60	6,0	10	030-8589-000	–	3,6	6,25	3,5	6,8	39,6	6,35	yellow
	VG95234P100	10,0	–	030-8590-000	–	3,6	6,25	4,8	6,8	39,6	6,35	–
	VG95234P60-001	2,0-3,0	14/12	030-8612-010	–	3,6	6,25	2,5	6,8	39,6	6,35	green
160/4	VG95234P4	–	4	030-8613-000	–	5,75	9,55	7,1	9,55	39,6	6,35	–
	VG95234P160	16,0	–	030-8591-000	–	5,75	9,55	6,2	9,55	39,6	6,35	–
		10,0	–	030-8591-020	–	5,75	9,55	4,8	9,55	39,6	6,35	–
	VG95234P160-001	–	6	030-8613-010	–	5,75	9,55	5,7	9,55	39,6	6,35	brown
500/0	VG95234P0	–	0	030-8614-000	–	9,1	13,55	11,5	14,35	41,0	6,35	–
	VG95234P500	50,0	–	030-8592-000	–	9,1	13,55	10,7	14,35	41,0	6,35	–
	VG95234P500-001	25,0	4	030-8614-010	–	9,1	13,55	7,6	14,35	41,0	6,35	white
	VG95234P500-002	35,0	2	030-8614-020	–	9,1	13,55	9,1	14,35	41,0	6,35	grey
		16,0	–	030-8614-030	–	9,1	13,55	6,2	14,35	41,0	6,35	–

Dimensions shown in mm

Specifications and dimensions subject to change

www.ittcannon.com



# Contacts

## Contacts

Standard contacts and contacts with reduced termination diameter

### Socket contacts

### Finish

- A36 – 5  $\mu$ m silver plated and passivated
- A176 – 2  $\mu$ m nickel plated, min. 0,5  $\mu$ m gold plated

Size 10/20

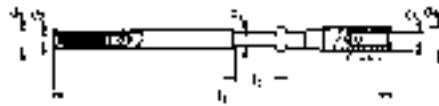

Size 25/12

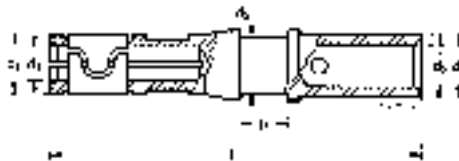
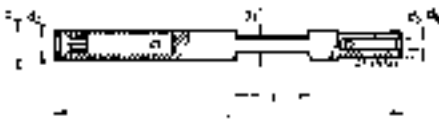
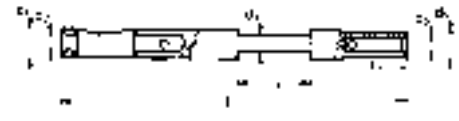

Size 15S/16S, 15/16

Size 60/100/8, 160/4, 500/0

Contact size	VG95234 Part no.	Wire size mm <sup>2</sup>	AWG	Part no. with finish Standard: A36 silver plated	Part no. with finish Mod. Code A176 gold plated	d <sub>1</sub>	d <sub>2</sub>	d <sub>3</sub>	d <sub>5</sub>	d <sub>6</sub>	l <sub>1</sub> ±0,2	l <sub>3</sub> ±0,1	Color Code
10/20	VG95234S10	0,5-1,0	20/18	031-8554-000	031-8554-006	2,0 <sup>-0,1</sup>	1,07	1,5 <sup>-0,05</sup>	1,5 <sup>+0,05</sup>	2,4 <sup>-0,05</sup>	36,8±0,3	4,75	–
	VG95234S10-001	0,2-0,4	26/22	031-8554-010	–	2,0 <sup>-0,1</sup>	1,07	1,5 <sup>-0,05</sup>	0,9 <sup>+0,05</sup>	2,4 <sup>-0,05</sup>	36,8±0,3	4,75	blue
15S/16S	VG95234S15S	0,75-1,5	18/16	031-8555-110	031-8555-115	3,2 <sup>-0,15</sup>	1,65	1,75 <sup>-0,1</sup>	1,75 <sup>+0,08</sup>	2,75 <sup>-0,05</sup>	29,1	3,9	–
	VG95234S15S-002	0,3-0,6	22/20	031-8688-110	031-8688-115	3,2 <sup>-0,15</sup>	1,65	1,75 <sup>-0,1</sup>	1,20 <sup>+0,1</sup>	2,75 <sup>-0,05</sup>	29,1	3,9	red
	VG95234S15S-001	0,14-0,38	22/26	031-8555-130	–	3,2 <sup>-0,15</sup>	1,65	1,75 <sup>-0,1</sup>	0,90 <sup>+0,05</sup>	2,75 <sup>-0,05</sup>	29,1	3,9	blue
15/16	VG95234S15	0,75-1,5	18/16	031-8556-110	031-8556-115	3,2 <sup>-0,15</sup>	1,65	1,75 <sup>-0,1</sup>	1,75 <sup>+0,08</sup>	2,75 <sup>-0,05</sup>	37,8	7,9	–
	VG95234S15-002	0,3-0,6	22/20	031-8639-120	031-8639-115	3,2 <sup>-0,15</sup>	1,65	1,75 <sup>-0,1</sup>	1,2 <sup>+0,1</sup>	2,75 <sup>-0,05</sup>	37,8	7,9	red
	VG95234S15-001	0,14-0,38	22/26	031-8556-130	–	3,2 <sup>-0,15</sup>	1,65	1,75 <sup>-0,1</sup>	0,9 <sup>+0,05</sup>	2,75 <sup>-0,05</sup>	37,8	7,9	blue
25/12	VG95234S25	2,0-3,0	14/12	031-8557-000	031-8557-006	4,8 <sup>-0,1</sup>	2,45	3,3 <sup>-0,1</sup>	2,5 <sup>+0,1</sup>	3,8 <sup>-0,1</sup>	37,0	7,9	–
	VG95234S25-001	0,75-1,5	18/16	031-8557-020	031-8557-026	4,8 <sup>-0,1</sup>	2,45	3,3 <sup>-0,1</sup>	1,75 <sup>+0,08</sup>	3,4 <sup>-0,1</sup>	37,0	7,9	black
		4,0	–	031-8557-010	–	4,8 <sup>-0,1</sup>	2,45	3,3 <sup>-0,1</sup>	2,8 <sup>+0,1</sup>	3,8 <sup>-0,1</sup>	37,0	7,9	–
		0,3-0,6	22/20	031-8557-040	–	4,8 <sup>-0,1</sup>	2,45	3,3 <sup>-0,1</sup>	1,2 <sup>+0,1</sup>	2,75 <sup>-0,1</sup>	37,0	7,9	–
60/100/8	VG95234S8	–	8	031-8519-000	031-8519-006	6,5 <sup>-0,2</sup>	3,65	6,25 <sup>-0,2</sup>	4,55 <sup>+0,1</sup>	6,8 <sup>-0,1</sup>	40,1	6,35	–
	VG95234S60	6,0	10	031-8558-000	–	6,5 <sup>-0,2</sup>	3,65	6,25 <sup>-0,2</sup>	3,5 <sup>+0,1</sup>	6,8 <sup>-0,1</sup>	40,1	6,35	yellow
	VG95234S100	10,0	–	031-8559-000	–	6,5 <sup>-0,2</sup>	3,65	6,25 <sup>-0,2</sup>	4,8 <sup>+0,1</sup>	6,8 <sup>-0,1</sup>	40,1	6,35	–
	VG95234S60-001	2,0-3,0	14/12	031-8519-010	–	6,5 <sup>-0,2</sup>	3,65	6,25 <sup>-0,2</sup>	2,5 <sup>+0,05</sup>	6,8 <sup>-0,1</sup>	40,1	6,35	green
160/4	VG95234S4	–	4	031-8520-000	–	8,6 <sup>-0,2</sup>	5,8	9,55 <sup>-0,2</sup>	7,1 <sup>+0,15</sup>	9,55 <sup>-0,1</sup>	40,1	6,35	–
	VG95234S160	16,0	–	031-8560-000	–	8,6 <sup>-0,2</sup>	5,8	9,55 <sup>-0,2</sup>	6,2 <sup>+0,15</sup>	9,55 <sup>-0,1</sup>	40,1	6,35	–
		10,0	–	031-8560-020	–	8,6 <sup>-0,2</sup>	5,8	9,55 <sup>-0,2</sup>	4,8 <sup>+0,1</sup>	9,55 <sup>-0,1</sup>	40,1	6,35	–
	VG95234S160-001	–	6	031-8520-010	–	8,6 <sup>-0,2</sup>	5,8	9,55 <sup>-0,2</sup>	5,7 <sup>+0,15</sup>	9,55 <sup>-0,1</sup>	40,1	6,35	brown
500/0	VG95234S0	–	0	031-8521-000	–	13,2 <sup>-0,2</sup>	9,15	13,55 <sup>-0,2</sup>	11,5 <sup>+0,15</sup>	14,35 <sup>-0,1</sup>	41,6	6,35	–
	VG95234S500	50,0	–	031-8561-000	–	13,2 <sup>-0,2</sup>	9,15	13,55 <sup>-0,2</sup>	10,7 <sup>+0,15</sup>	14,35 <sup>-0,1</sup>	41,6	6,35	–
	VG95234S500-001	25,0	4	031-8521-010	–	13,2 <sup>-0,2</sup>	9,15	13,55 <sup>-0,2</sup>	7,6 <sup>+0,15</sup>	14,35 <sup>-0,1</sup>	41,6	6,35	white
	VG95234S500-002	35,0	2	031-8521-020	–	13,2 <sup>-0,2</sup>	9,15	13,55 <sup>-0,2</sup>	9,1 <sup>+0,15</sup>	14,35 <sup>-0,1</sup>	41,6	6,35	grey
	16,0	–	031-8521-030	–	13,2 <sup>-0,2</sup>	9,15	13,55 <sup>-0,2</sup>	6,2 <sup>+0,15</sup>	14,35 <sup>-0,1</sup>	41,6	6,35	–	

# Contacts

## Tools

For pin and socket contacts according VG95234 and for Cannon contacts with reduced coupling dimensions.

Contact Size	Wire size mm <sup>2</sup>	AWG	Hand Crimp Tools	Order Reference	Crimp Locator	Order Reference	
10	0,5-1,0	20/18			600325 (mod.TH 452)	121586-0034	
	0,2-0,4	26/22					
Pin	15S/16S	0,75-1,5					18/16
		0,3-0,6					22/20
		0,14-0,38					22/26
Socket	15S/16S	0,750-1,5	18/16	M22520-1-01	995-0001-585	600324 (mod.TH 452)	121586-0033
		0,3-0,6	22/20				
		0,14-0,38	22/26				
	15/16	0,75-1,5	18/16		TH 452	995-0002-052	
		0,3-0,6	22/20				
		0,14-0,38	22/26				
	25/12	2,0-3,0	14/12				
		0,75-1,5	18/16				
	4						
			<b>Hydraulic Handpump</b>	<b>Order Number</b>	<b>Electro Hydraulic Tool</b>	<b>Order Number</b>	
60/100/8	6 2,0-3,0	8 10 14/12	HPW400U-ITT	121586-5257	HP400EL-ITT	121586-5253	
160/4	16 10	4 6					
500/0	50 25 35 16	0 - 4 2 -					

## Crimp Contacts

Connectors of series CA-COM and CA-COM-B are also available with crimp contacts for AWG wire sizes. In order to wire, insert and extract these contacts the tools mentioned on this page are needed. All tools have to be ordered separately.

Insertion Tools		Insertion Pliers		Extraction Tools		Guiding Pins for Socket Contacts
Part No.	Order Reference	Part No.	Order Reference	Part No.	Order Reference	
CIT 20	121086-3009	CIT-F80-20	121086-0098	CET-F80-20	121086-0082	
CIT 16	121086-3008	CIT-F80-16	121086-0097	CET-F80-16	121086-0081	27977-16T50
CIT 12	121086-3007	CIT-F80-12	121086-0096	CET-F80-12	121086-0080	27977-12T8
CIT 8	121086-0095			CET-8	121086-0079	
CIT 4	121086-0094			CET-4	121086-0078	
CIT 0	121086-0093			CET-0	121086-0077	

# Contacts

## Basic - Hydraulic - Electrically driven tool

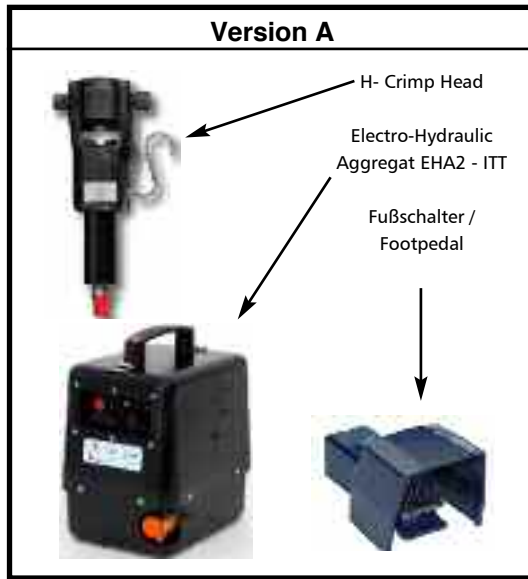

## Basic - Hydraulic - Manual Operated tool

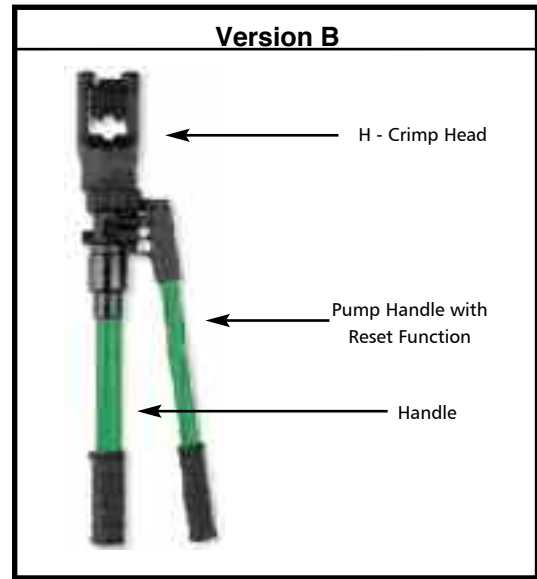

Version	Description	Marking	Part Number
A	Electro-Hydraulic - Agregat with footpedal	HP400EL-ITT	121586-5253
B	Manually operated Hydraulic handtool	EPK400U-ITT	121586-5257

## Crimp Dies

Product Line	Contact Size	Part Number	Hex. Diameter	Stamped label	Cable Size	
					AWG	mm <sup>2</sup>
MS/CA VG 95234	60/100/8	121586-5231	5,20	01	8	6/10
	160/4	121586-5230	7,25	02	4	16
	500/0	121586-5229	11,40	03	0	50
Locator	MS / CA	121586-5232				



Crimp die with locator



Crimp die



Locator

### Notes

1. For large series production, semi-automatic crimp machine Type HACS-IV-MSXX upon request
2. For insertion and extraction of the contacts and for connector assembly, see Assembly Instructions MIL-C-5015/VG95234
3. Standard contacts acc. to MIL-C-5015/VG95234

\* Datasheet available upon request



# Part Number Search

## Part Number Search

Part Number	Page	Part Number	Page	Part Number	Page	Part Number	Page	Part Number	Page
012-0218-000	57	031-8554-006	60	248-8501-000	55	CA121003-8	54	CAB80-32-D	54
012-0219-000	57	031-8554-010	60	248-8502-000	55	CA121003-80	54	CAB80-36-D	54
012-0220-000	57	031-8555-110	60	248-8503-000	55	CA121003-81	54	CAB81-10SL-D	54
012-0223-000	57	031-8555-115	60	248-8504-000	55	CA121003-82	54	CAB81-12S-D	54
012-8552-000	57	031-8555-130	60	248-8505-000	55	CA121003-9	54	CAB81-14S-D	54
012-8554-000	57	031-8556-110	60	248-8506-000	55	CA121004-1	54	CAB81-16-D	54
012-8555-000	57	031-8556-115	60	248-8507-000	55	CA121004-10	54	CAB81-16S-D	54
012-8556-000	57	031-8556-130	60	248-8508-000	55	CA121004-11	54	CAB81-18-D	54
012-8557-000	57	031-8557-000	60	248-8509-000	55	CA121004-12	54	CAB81-20-D	54
012-8558-000	57	031-8557-006	60	248-8510-000	55	CA121004-121	54	CAB81-22-D	54
012-8558-000	57	031-8557-010	60	248-8511-000	55	CA121004-122	54	CAB81-24-D	54
025-8636-005	53	031-8557-020	60	248-8512-000	55	CA121004-123	54	CAB81-28-D	54
025-8636-006	53	031-8557-026	60	248-8513-000	55	CA121004-124	54	CAB81-32-D	54
025-8636-008	53	031-8557-040	60	248-8514-000	55	CA121004-125	54	CAB81-36-D	54
025-8636-010	53	031-8558-000	60	248-8515-000	55	CA121004-126	54	CET-0	61
025-8636-016	53	031-8559-000	60	248-8516-000	55	CA121004-127	54	CET-4	61
025-8636-017	53	031-8560-000	60	248-8517-000	55	CA121004-128	54	CET-8	61
025-8636-018	53	031-8560-020	60	248-8518-000	55	CA121004-129	54	CET-F80-12	61
025-8636-022	53	031-8561-000	60	248-8519-000	55	CA121004-130	54	CET-F80-16	61
025-8636-024	53	031-8639-115	60	248-8520-000	55	CA121004-131	54	CET-F80-20	61
025-8636-025	53	031-8639-120	60	248-8521-000	55	CA121004-132	54	CIT 0	61
025-8636-026	53	031-8688-110	60	248-8522-000	55	CA121004-161	54	CIT 12	61
025-8636-034	53	031-8688-115	60	248-8523-000	55	CA121004-162	54	CIT 20	61
025-8636-036	53	075-8501-000	58	248-8524-000	55	CA121004-163	54	CIT 4	61
025-8636-042	53	075-8501-001	58	330-8659-000	59	CA121004-164	54	CIT 8	61
025-8636-044	53	075-8502-000	58	330-8659-006	59	CA121004-165	54	CIT-F80-12	61
025-8636-048	53	075-8502-001	58	330-8744-000	59	CA121004-166	54	CIT-F80-16	61
025-8636-049	53	075-8503-000	58	330-8744-006	59	CA121004-167	54	CIT-F80-20	61
025-8636-053	53	075-8503-001	58	600324	61	CA121004-168	54	CT 16	61
025-8636-054	53	075-8504-000	58	600325	61	CA121004-169	54	HP400EL-ITT	61, 62
025-8636-058	53	075-8504-001	58	995-0001-585	61	CA121004-170	54	HPW400U-ITT	61
025-8636-060	53	075-8505-000	58	995-02-52	61	CA121004-171	54	M22520-1-01	61
025-8636-061	53	075-8505-001	58	CA121003-1	54	CA121004-172	54	MS3420-04	57
025-8636-062	53	075-8506-000	58	CA121003-10	54	CA121004-2	54	MS3420-06	57
025-8636-064	53	075-8506-001	58	CA121003-11	54	CA121004-3	54	MS3420-08	57
025-8636-065	53	075-8507-000	58	CA121003-12	54	CA121004-4	54	MS3420-10	57
030-8585-000	59	075-8507-001	58	CA121003-121	54	CA121004-5	54	MS3420-12	57
030-8585-006	59	075-8508-000	58	CA121003-122	54	CA121004-6	54	MS3420-16	57
030-8585-010	59	075-8508-001	58	CA121003-123	54	CA121004-7	54	MS3420-18	57
030-8586-000	59	075-8509-000	58	CA121003-124	54	CA121004-71	54	MS3420-20	57
030-8586-006	59	075-8509-001	58	CA121003-125	54	CA121004-72	54	MS3420-24	57
030-8586-010	59	075-8510-000	58	CA121003-126	54	CA121004-73	54	TH 452	61
030-8587-000	59	075-8510-001	58	CA121003-127	54	CA121004-74	54	VG95234 DA 10SL-X	58
030-8587-006	59	075-8511-000	58	CA121003-128	54	CA121004-75	54	VG95234 DA 14S-X	58
030-8587-030	59	075-8511-001	58	CA121003-129	54	CA121004-76	54	VG95234 DA 16X	58
030-8587-036	59	075-8512-000	58	CA121003-130	54	CA121004-77	54	VG95234 DA 18-X	58
030-8588-000	59	075-8512-001	58	CA121003-131	54	CA121004-78	54	VG95234 DA 20-X	58
030-8588-006	59	075-8513-000	58	CA121003-132	54	CA121004-79	54	VG95234 DA 22-X	58
030-8588-010	59	075-8513-001	58	CA121003-161	54	CA121004-8	54	VG95234 DA 24-X	58
030-8588-016	59	075-8514-000	58	CA121003-162	54	CA121004-80	54	VG95234 DA 28-X	58
030-8588-054	59	075-8514-001	58	CA121003-163	54	CA121004-81	54	VG95234 DA 32-X	58
030-8589-000	59	075-8515-000	58	CA121003-164	54	CA121004-82	54	VG95234 DA 36-X	58
030-8590-000	59	075-8515-001	58	CA121003-165	54	CA121004-9	54	VG95234 DH 14S-X	58
030-8591-000	59	075-8516-000	58	CA121003-166	54	CA3105E10SL-B	55	VG95234 DH 16X	58
030-8591-020	59	075-8516-001	58	CA121003-167	54	CA3105E12S-B	55	VG95234 DH 18-X	58
030-8592-000	59	075-8517-000	58	CA121003-168	54	CA3105E14S-B	55	VG95234 DH 20-X	58
030-8612-000	59	075-8517-001	58	CA121003-169	54	CA3105E16-B	55	VG95234 DH 22-X	58
030-8612-006	59	075-8518-000	58	CA121003-170	54	CA3105E16S-B	55	VG95234 DH 24-X	58
030-8612-010	59	075-8518-001	58	CA121003-171	54	CA3105E18-B	55	VG95234 DH 28-X	58
030-8613-000	59	075-8519-000	58	CA121003-172	54	CA3105E20-B	55	VG95234 DH 32-X	58
030-8613-010	59	075-8519-001	58	CA121003-2	54	CA3105E22-B	55	VG95234 DH 36-X	58
030-8614-000	59	075-8520-000	58	CA121003-3	54	CA3105E24-B	55	VG95234A-10SL	31
030-8614-010	59	075-8520-001	58	CA121003-4	54	CA3105E28-B	55	VG95234A-14S	31
030-8614-020	59	075-8521-000	58	CA121003-5	54	CA3105E32-B	55	VG95234A-16	31
030-8614-030	59	075-8521-001	58	CA121003-6	54	CA3105E36-B	55	VG95234A-16S	31
031-8519-000	60	075-8522-000	58	CA121003-7	54	CAB80-10SL-D	54	VG95234A-18	31
031-8519-006	60	075-8522-001	58	CA121003-71	54	CAB80-12S-D	54	VG95234A-20	31
031-8519-010	60	121586-0033	61	CA121003-72	54	CAB80-14S-D	54	VG95234A-22	31
031-8520-000	60	121586-0034	61	CA121003-73	54	CAB80-16-D	54	VG95234A-24	31
031-8520-010	60	121586-5229	62	CA121003-74	54	CAB80-16S-D	54	VG95234A-28	31
031-8521-000	60	121586-5230	62	CA121003-75	54	CAB80-18-D	54	VG95234A-32	31
031-8521-010	60	121586-5231	62	CA121003-76	54	CAB80-20-D	54	VG95234A-36	31
031-8521-020	60	121586-5232	62	CA121003-77	54	CAB80-22-D	54	VG95234B00	56
031-8521-030	60	121586-5253	61, 62	CA121003-78	54	CAB80-24-D	54	VG95234B04	56
031-8554-000	60	121586-5257	61, 62	CA121003-79	54	CAB80-28-D	54	VG95234B08	56





# Part Number Search

## Part Number Search

Part Number	Page	Part Number	Page
VG95234B12.....	56	VG95234P10.....	59
VG95234B16.....	56	VG95234P100.....	59
VG95234B16S.....	56	VG95234P10-001.....	59
VG95234B20.....	56	VG95234P15.....	59
VG95234BOD10SL.....	55	VG95234P15-001.....	59
VG95234BOD14S.....	55	VG95234P15-002.....	59
VG95234BOD16.....	55	VG95234P15S.....	59
VG95234BOD16S.....	55	VG95234P15S-001.....	59
VG95234BOD18.....	55	VG95234P15S-002.....	59
VG95234BOD20.....	55	VG95234P160.....	59
VG95234BOD22.....	55	VG95234P160-001.....	59
VG95234BOD24.....	55	VG95234P25.....	59
VG95234BOD28.....	55	VG95234P25-001.....	59
VG95234BOD32.....	55	VG95234P4.....	59
VG95234BOD36.....	55	VG95234P500.....	59
VG95234KA10SL.....	54	VG95234P500-001.....	59
VG95234KA14S.....	54	VG95234P500-002.....	59
VG95234KA16.....	54	VG95234P60.....	59
VG95234KA16S.....	54	VG95234P60-001.....	59
VG95234KA18.....	54	VG95234P8.....	59
VG95234KA20.....	54	VG95234R1-14S.....	38
VG95234KA22.....	54	VG95234R1-16S.....	38
VG95234KA24.....	54	VG95234R1-18.....	38
VG95234KA28.....	54	VG95234R1-20.....	38
VG95234KA32.....	54	VG95234R1-28.....	38
VG95234KA36.....	54	VG95234R1-32.....	38
VG95234KB10SL.....	54	VG95234S0.....	60
VG95234KB14S.....	54	VG95234S10.....	60
VG95234KB16.....	54	VG95234S10-001.....	60
VG95234KB16S.....	54	VG95234S1-14.....	39
VG95234KB18.....	54	VG95234S1-16S.....	39
VG95234KB20.....	54	VG95234S1-18.....	39
VG95234KB22.....	54	VG95234S1-20.....	39
VG95234KB24.....	54	VG95234S1-28.....	39
VG95234KB28.....	54	VG95234S1-32.....	39
VG95234KB32.....	54	VG95234S15.....	60
VG95234KB38.....	54	VG95234S15-001.....	60
VG95234KC10SL.....	54	VG95234S15-002.....	60
VG95234KC14S.....	54	VG95234S15S.....	60
VG95234KC16.....	54	VG95234S15S-001.....	60
VG95234KC16S.....	54	VG95234S15S-002.....	60
VG95234KC18.....	54	VG95234S160.....	60
VG95234KC20.....	54	VG95234S160-001.....	60
VG95234KC22.....	54	VG95234S25.....	60
VG95234KC24.....	54	VG95234S25-001.....	60
VG95234KC28.....	54	VG95234S4.....	60
VG95234KC32.....	54	VG95234S500.....	60
VG95234KC36.....	54	VG95234S500-001.....	60
VG95234KK 4.....	57	VG95234S500-002.....	60
VG95234KK 6.....	57	VG95234S60.....	60
VG95234KK 8.....	57	VG95234S60-001.....	60
VG95234KK12.....	57	VG95234S8.....	60
VG95234KK16.....	57		
VG95234KK20.....	57		
VG95234KK24.....	57		
VG95234KR10SL.....	54		
VG95234KR14S.....	54		
VG95234KR16.....	54		
VG95234KR16S.....	54		
VG95234KR18.....	54		
VG95234KR20.....	54		
VG95234KR22.....	54		
VG95234KR24.....	54		
VG95234KR28.....	54		
VG95234KR32.....	54		
VG95234KR38.....	54		
VG95234KT10SL.....	57		
VG95234KT14S.....	57		
VG95234KT16V.....	57		
VG95234KT18.....	57		
VG95234KT20.....	57		
VG95234KT24.....	57		
VG95234KT28.....	57		
VG95234KT32.....	57		
VG95234P0.....	59		

Dimensions shown in mm

Specifications and dimensions subject to change

[www.ittcannon.com](http://www.ittcannon.com)



# Product Safety Information

THIS NOTE MUST BE READ IN CONJUNCTION WITH THE PRODUCT DATA SHEET/CATALOG. FAILURE TO OBSERVE THE ADVICE IN THIS INFORMATION SHEET AND THE OPERATING CONDITIONS SPECIFIED IN THE PRODUCT DATA SHEET/ CATALOG COULD RESULT IN HAZARDOUS SITUATIONS.

## 1. MATERIAL CONTENT AND PHYSICAL FORM

Electrical connectors do not usually contain hazardous materials. They contain conducting and non-conducting materials and can be divided into two groups.

a) Printed circuit types and low cost audio types which employ all plastic insulators and casings.

b) Rugged, Fire Barrier and High Reliability types with metal casings and either natural rubber, synthetic rubber, plastic or glass insulating materials. Contact materials vary with type of connector and also application and are usually manufactured from either: Copper, copper alloys, nickel, alumel, chromel or steel. In special applications, other alloys may be specified.

## 2. FIRE CHARACTERISTICS AND ELECTRIC SHOCK HAZARD

There is no fire hazard when the connector is correctly wired and used within the specified parameters. Incorrect wiring or assembly of the connector or careless use of metal tools or conductive fluids, or transit damage to any of the component parts may cause electric shock or burns. Live circuits must not be broken by separating mated connectors as this may cause arcing, ionization and burning. Heat dissipation is greater at maximum resistance in a circuit. Hot spots may occur when resistance is raised locally by damage, e.g. cracked or deformed contacts, broken strands of wire. Local overheating may also result from the use of the incorrect application tools or from poor quality soldering or slack screw terminals. Overheating may occur if the ratings in the product Data Sheet/Catalog are exceeded and can cause breakdown of insulation and hence electric shock. If heating is allowed to continue it intensifies by further increasing the local resistance through loss of temper of spring contacts, formation of oxide film on contacts and wires and leakage currents through carbonization of insulation and tracking paths. Fire can then result in the presence of combustible materials and this may release noxious fumes. Overheating may not be visually apparent. Burns may result from touching overheated components.

## 3. HANDLING

Care must be taken to avoid damage

to any component parts of electrical connectors during installation and use. Although there are normally no sharp edges, care must be taken when handling certain components to avoid injury to fingers. Electrical connectors may be damaged in transit to the customers, and damage may result in creation of hazards. Products should therefore be examined prior to installation/use and rejected if found to be damaged.

## 4. DISPOSAL

Incineration of certain materials may release noxious or even toxic fumes.

## 5. APPLICATION

Connectors with exposed contacts should not be selected for use on the current supply side of an electrical circuit, because an electric shock could result from touching exposed contacts on an unmated connector. Voltages in excess of 30 V ac or 42.5 V dc are potentially hazardous and care should be taken to ensure that such voltages cannot be transmitted in any way to exposed metal parts of the connector body. The connector and wiring should be checked, before making live, to have no damage to metal parts or insulators, no solder blobs, loose strands, conducting lubricants, swarf, or any other undesired conducting particles. Circuit resistance and continuity check should be made to make certain that there are no high resistance joints or spurious conducting paths. Always use the correct application tools as specified in the Data Sheet/Catalog. Do not permit untrained personnel to wire, assemble or tamper with connectors. For operation voltage please see appropriate national regulations.

## IMPORTANT GENERAL INFORMATION

(i) Air and creepage paths/Operating voltage. The admissible operating voltages depend on the individual applications and the valid national and other applicable safety regulations.

For this reason the air and creepage path data are only reference values. Observe reduction of air and creepage paths due to PC board and/or harnessing.

(ii) Temperature

All information given are temperature limits. The operation temperature depends on the individual application.

(iii) Other important information

Cannon continuously endeavors to improve their products. Therefore, Cannon products may deviate from the description, technical data and shape as shown in this catalog and data sheets.

“Engineered for life” is a registered trademark of ITT Industries, ©2005. All

other trademarks or registered trademarks are property of their respective owners. All data subject to change without notice.

## Product Warranty

ITT Cannon, a Division of ITT Industries, Inc. manufactures the highest quality products available in the marketplace; however these products are intended to be used in accordance with the specifications in this publication. Any use or application that deviates from the stated operating specifications is not recommended and may be unsafe. No information and data contained in this publication shall be construed to create any liability on the part of Cannon. Any new issue of this publication shall automatically invalidate and supersede any and all previous issues. A limited warranty applies to Cannon products. Except for obligations assumed by Cannon under this warranty, Cannon shall not be liable for any loss, damage, cost of repairs, incidental or consequential damages of any kind, whether or not based on express or implied warranty, contract, negligence or strict liability arising in connection with the design, manufacture, sale, use or repair of the products. Product availability, prices and delivery dates are exclusively subject to our respective order confirmation form; the same applies to orders based on development samples delivered. This publication is not to be construed as an offer. It is intended merely as an invitation to make an offer. By this publication, Cannon does not assume responsibility or any liability for any patent infringements or other rights of third parties which may result from its use. Reprinting this publication is generally permitted, indicating the source. However, Cannon's prior consent must be obtained in all cases.



## Circular/Filter/Hermetic Connectors

As a world leader in circular, filter, and hermetic connectors, ITT can leverage its design and manufacturing expertise to fit virtually any application. Our expertise includes fast positive mating for a wide range of military applications, as well as numerous sizes and contact configurations for various harsh environments. ITT can meet numerous specs, including NATO and MIL standards.

[www.ittcannon.com/circulars](http://www.ittcannon.com/circulars) • [www.ittcannon.com/filter](http://www.ittcannon.com/filter) • [www.ittcannon.com/hermetics](http://www.ittcannon.com/hermetics)



## D-Subminiature Connectors

Cannon invented D-sub connectors in 1952. Our family of D-Subs now includes combinations of signal, power and RF, as well as severe service sealed connectors. Cannon D-Subs are available with an extensive line of backshells and accessories and are one of the most economical shielded connector solutions available. ITT D-Sub connectors are qualified to the MIL-DTL-24308 specification.

[www.ittcannon.com/dsubs](http://www.ittcannon.com/dsubs)



## Fiber Optic Connectors and Cable Assemblies

Cannon fiber optic solutions provide an excellent performance/cost value. Performance may be tailored to the end system, with our use of superior materials and bonding agents providing highly effective solutions. Our wide variety of products includes fiber optic hybrid contacts, multi-channel, rack and panel, and hi-rel assemblies, including MIL and ARINC standard solutions.

[www.ittcannon.com/fiberoptics](http://www.ittcannon.com/fiberoptics)



## Microminiature Connectors

Developed first by Cannon in the 1960's, Interconnect Solutions microminiature connectors offer high performance and reliability with exceptional versatility. Available in rectangular, circular, and strip configurations for countless applications, many of our connectors meet or exceed applicable requirements of the MIL-DTL-83513 specification.

[www.ittcannon.com/micro](http://www.ittcannon.com/micro)



## Rack and Panel Connectors

Initially pioneered by Cannon during the 1930s, Interconnect Solutions is the world leader in rack and panel connectors, offering unmatched variety of shell configurations and insert arrangements, materials, plating, and contact options. Many of our standard and custom designs meet the stringent requirements of ARINC 600, ARINC 404 (MIL-C-81659), and MIL-DTL-83733 standards.

[www.ittcannon.com/rackandpanel](http://www.ittcannon.com/rackandpanel)



## RF Connectors

ITT Interconnect Solutions has been providing interconnect products to the Microwave and RF industry since 1963 (formerly The Sealectro Corporation). The RF 50 & 75 Ohm product lines cover UHF band through Ku band requirements. These connectors and cable assemblies are available with a thread type, snap type, bayonet type or slide on coupling method. The frequencies range from DC to 18+ GHz.

[www.ittcannon.com/RF50](http://www.ittcannon.com/RF50) • [www.ittcannon.com/RF75](http://www.ittcannon.com/RF75)





**ITT Interconnect Solutions**  
Cannon, VEAM, BIW

Visit our website at  
[www.ittcannon.com](http://www.ittcannon.com)



**Global Design & Manufacturing**

**Customer Support**

### North America

- MEXICO - Cannon, VEAM**  
Av. Libre Comercio s/n-  
entre Calzada Industrial  
Nuevo Nogales y Calzada del Raquet Club,  
Parque Industrial Nuevo Nogales  
phone: +52.631.3110050  
fax: +52.631.3110060
- USA - Cannon**  
666 East Dyer Road  
Santa Ana, CA 92705  
toll free: +1.800.854.3028  
phone: +1.714.557.4700  
fax: +1.714.628.2142
- USA - BIW**  
500 Tesconi Circle  
Santa Rosa, CA 95401  
phone: +1.707.523.2300  
fax: +1.707.523.3567
- USA - VEAM**  
100 New Wood Road  
Watertown, CT 06795  
phone: +1.860.274.9681  
fax: +1.860.274.4963

### Europe & Middle East

- FRANCE - Cannon, VEAM**  
15, Boulevard Robert Thiboust  
Serris, France 77700  
phone: +33.1.60.04.93.93  
fax: +33.1.60.04.93.90
- GERMANY - Cannon, VEAM**  
ITT Cannon GmbH  
Cannonstrasse 1  
Weinstadt, 71384  
phone: +49.7151.699.0  
fax: +49.7151.699.217
- ITALY - Cannon, VEAM**  
Corso Europa 41/43  
Lainate (MI), Italy 20020  
phone: +39.02938721  
fax: +39.0293872300
- LEBANON - BIW**  
P.O. Box 199  
Jounieh  
Lebanon  
phone: +961.9.911.560  
fax: +961.9.912.126
- UK - Cannon, VEAM**  
Jays Close, Viabes Estate  
Basingstoke, RG22 4BA  
phone: +44.1256.311200  
fax: +44.1256.323356

### Asia

- CHINA - Cannon, VEAM**  
Tuopandun Industrial Area,  
Jinda Cheng, Xiner Village, Shajing Town,  
Baoan District, Shenzhen City,  
Guangdong, China 518125  
phone: +86.755.2726.7238  
fax: +86.755.2726.7515
- HONG KONG - Cannon, VEAM**  
Units 2405-6, 24/F, ING Tower  
308 Des Voeux Road  
Central  
Hong Kong  
phone: +852.2732.2720  
fax: +852.2732.2919
- INDIA - Cannon, VEAM**  
ITT Corporation India Pvt Ltd  
Money Chamber, Unit No. 202  
#6, KH Road, Bangalore  
560027  
phone: +91 80 41465632  
fax: +91 80 41465631
- JAPAN - Cannon, VEAM**  
11-3, 5 Chome, Hibarigaoka,  
Zama-shi, Kanagawa, Japan 228-0003  
phone: +81.462.57.2010  
fax: +81.462.57.1680
- SINGAPORE - Cannon, VEAM**  
10 Jalan Kilang #06-01  
Singapore 159410  
phone: +65.62763693 ext 232  
fax: +65.62763685



ENGINEERED FOR LIFE

## X-ON Electronics

Largest Supplier of Electrical and Electronic Components

*Click to view similar products for [Circular MIL Spec Connector](#) category:*

*Click to view products by [ITT](#) manufacturer:*

Other Similar products are found below :

[89075GULPR](#) [0025-262-542](#) [0025-264-3014](#) [58-570121-04S](#) [0134-213-1208](#) [0134-213-2209](#) [0025-258-000](#) [60-042022-07P](#) [60-042022-19P](#)  
[60-042022-23P](#) [60-042217-10P](#) [60-042217-11P](#) [0114-201-1278](#) [012-0467-000](#) [602GB06EG24-61SN](#) [0134-201-1207](#) [0134-213-1006](#) [6104-](#)  
[207-2302](#) [6104-208-1902](#) [61-168211-04P](#) [61-168617-10P](#) [6131-202-19149P](#) [6131-204-21149P](#) [6131-208-13149P](#) [6131-209-17149P](#) [6131-](#)  
[210-11149P](#) [6131-211-19149P](#) [6131-216-19149P](#) [6131-259-21149P](#) [6131-259-23149P](#) [6131-265-17149P](#) [6131-265-19149P](#) [CS3100A18-1P-](#)  
[472](#) [CS3100A-36-77P](#) [CS3101A-16-55P](#) [CS3102A-10SL-55P](#) [CS3102A-14S-58P](#) [CS3102A-18-1P116](#) [CS3102A-32-17P](#) [CS3102A32-25S](#)  
[CS3102C18-4P-472](#) [CS3106A10SL3S004](#) [CS3106A-18-73S](#) [CS3108A-14S-52S](#) [CS3108A-28-51S](#) [6162-233-1277](#) [6162-324-1231](#)  
[M243082296Z](#) [M2884010AC1S1](#) [CT0-24-10SC](#)