



ITT

Interconnect Solutions
Canon, VEAM, BIW

Defining **innovative**
aviation, military, and
industrial circulars since the DC-1,
over **70 years** ago



Engineered for life

MS-E/F/R/ER MIL-C-5015 Connectors

ITT Cannon is the foremost manufacturer of MS and MS type connectors with the widest range of connector styles, sizes and variations in the industry. These connectors utilize the finest materials, which, along with precision manufacturing and rigid quality control, assure ITT Cannon customers of the finest quality connectors.

These circular connectors were originally designed for aircraft, but are now widely used in many other fields. They are particularly suitable for commercial applications requiring low cost and high reliability.



ENVIRONMENTAL RESISTANT MS-E, MS-F, MS-R, AND F80 (Solder/Crimp Termination)

MS-E, MS-F and MS-R are similar to MS-A and MS-B connectors but have resilient insulators and wire sealing grommets for extreme environmental conditions and high altitude sealing. MS-E's and MS-F's have a mechanical cable clamp; the MS-R has a shorter, lighter weight endbell without the cable clamp. Both the MS-F and MS-R have O rings to supplement the interfacial seal. Shells are aluminum alloy. Contacts are silver plated copper alloy. The F80 modification (crimp contact termination) is available in E, R, F and BFR styles with resilient insulators.

POTTING ER CONNECTORS (Solder Contact Termination)

These Lightweight potting connectors provide resistance to salt water, fuels, etc., and will withstand the effects of high vibration. 3100 and 3106 connectors with plastic potting cups and resilient inserts meet the requirements of MS3103 and MS25183. Contacts are silver plated copper or brass. ER insulators are resilient; shells are aluminum alloy. A 90° plug (3108ER) is also available.



ACCESSORIES

Accessories to fit MS connectors include junction shells, protective caps, dummy or stowage receptacles, cable clamps, telescoping bushings.



A

Circular

How to Order

In the latest revision of MIL-C-5015, a new class of environment-resistant connectors was added. This new class F connector supersedes the previous class E connector. The MS3106F has an O ring under the coupling nut. The class E will be available upon request for existing programs, and upon ordering will also bear the E nomenclature on the shell.

MS-F and MS-R connectors are designed to operate in the extreme environmental conditions of high altitude flight and must be completely sealed to withstand moisture, condensation, vibration, corona and flashover caused by high altitude environments. They have resilient grommet with internal restrictions in the wire cavities which act as O rings around the wires. This allows the wires to slide thru the grommet with a minimum of friction, yet when the ferrule is seated and the endbell tightened it provides a perfect wire seal thru a wide variety of wire diameters. This seal at the rear, plus the interfacial seal at the front, effects a completely environment-resistant assembly when the plug is mated to and F or R receptacle. Sockets are of the closed-entry type.

The temperature range for this connector is -55°C (67°F) to +125° (+257°F) and meets the requirements of MIL-C-5015.

The F80 modification (crimp contact termination) is available in resilient insulators in the E, R, F, and BFR styles, creating a large selection of insert assemblies and hardware. Components are identical to the MS-5015 except that the contacts are modified for crimp termination providing and inexpensive crimp contact connector with the proven reliability of and complete intermateability with the MS-5015 series. Cable clamps have been integrally designed with the endbell on MS-E and MS-F connectors. Class R is without the cable clamp.

	MS	3106	R	18	-	1	P	W	*
	CA	3106	F	18	-	1	S	-	F80*
PREFIX	_____								
SHELL STYLE	_____								
CLASS	_____								
SHELL SIZE	_____								
CONTACT ARRANGEMENT	_____								
CONTACT TYPE	_____								
ALTERNATE INSERT POSITION	_____								
MODIFICATION CODE	_____								

PREFIX
MS - Conforms to latest MIL-C-5015 revision.
CA - Cannon designation (for any modification)
CAR - RoHS compliant

SHELL STYLE
3100 - Wall mounting receptacle
3101 - Cable connecting plug
3102 - Box mounting receptacle
3106 - Straight plug
3108 - 90° angle plug

CLASS
E - with resilient insulator and integral clamp for cable strain relief
F - same as E, however style 3106 with O-ring seal under the coupling nut

* When ordering MS3106F to the Cannon part number, designate CA06R.

SHELL SIZE
10S, 12S, 14S, 16S, 16, 18, 20, 22, 24, 28, 32 and 36.

CONTACT ARRANGEMENTS
See pages A-85 to A-89

CONTACT TYPE
P - Pin
S - Socket

ALTERNATE INSERT POSITION
W, X, Y and Z (omit for "Normal"), see page A-89

MODIFICATION CODE
A71 - Electroless Nickel Hardware, RoHS
A176 - Contacts hard gold over nickel, RoHS
A206 - Black zinc cobalt hardware, RoHS
F42 - Connector supplied without endbell, grommet and ferrule
F80 - Snap-in crimp contacts
F183 - Snap-in crimp contacts for metric conductors
DN - CA3106 (plug only), endbell for shrink boot adapter
A232 - Black zinc cobalt hardware, RoHS European version
A233 - Green zinc cobalt hardware, European version

Dimensions shown in inches (mm)
Specifications and dimensions subject to change

www.ittcannon.com



**MIL-DTL-5015
MS-E/F/R**



Circular

A

MATERIALS AND FINISHES

Shell	Material Finish	Aluminum Alloy O.D. Chromate coating over cadmium plating
Insulator	Material	Polychloroprene (resilient)
Contacts	Material Finish Termination	Brass or copper alloy Silver plate Tinned solder pot

WIRING

For class E, F, and R connectors, satisfactory moisture sealing will be obtained if AWG and MS wire sizes and insulation outside diameters are governed by this table.

Contact Size	Wire Size (MIL-W-5086)	Insulation OD Limit (inches)
16	16 thru 20	.064 (1.63) min. to .130 (3.30) max.
12	12 thru 14	.114 (2.90) min. to .170 (4.32) max.
8	8 thru 10	.164 (4.17) min. to .255 (6.48) max.
4	4 thru 6	.275 (6.98) min. to .370 (9.40) max.
0	0 thru 2	.415 (10.54) min to .550 (13.97) max.

ELECTRICAL SERVICE DATA

Test current ratings of contacts and allowable voltage drop under test conditions when assembled as in service are shown below. Maximum total current to be carried per connector is the same as the allowable in wire bundles as specified in MIL-W-5088.

Contact Size	Test Current (amps)	Potential Drop (millivolts)
16	13	49
12	23	42
8	46	26
4	80	23
0	150	21

Performance and Material Specifications

THERMOCOUPLE CONTACTS

Sizes 12 and 16 contacts, machined from matching thermocouple lead wire alloys, can be supplied in ITT Cannon connectors. These thermocouple contacts maintain continuity from thermal-sensor leads through a bulkhead of other closures in temperature measuring applications.

These contacts for matching lead wires are detailed by the standards of the Instrument Society of America (ISA).

ISA Standards	Material
J and Y	Iron and constantan
K	Chromel and alumel
T	Copper and constantan

Since the thermocouple connector applications determines the soldering methods and materials to be used, thermocouple contacts, identified by permanent markings, are normally supplied with untinned solder pots. Thermocouple contacts are supplied only in connectors having resilient insulators.

HIGH POTENTIAL TEST VOLTAGE

MS connectors show no evidence of breakdown when the test voltage given below is applied between the two closest contacts and between the shell and the contacts closest to the shell for a period of one minute.

MS Service Rating	Test Voltage (RMS) 60 cps	Suggested* Operating Voltages DC	Suggested* Operating Voltages AC (rms)	Air Spacing Nom. (inches)	Creepage Distance Nom. (inches)
Inst.	1000	250	200		1/16
A	2000	700	500	1/16	1/8
D	2800	1250	900	1/8	3/16
E	3500	1750	1250	3/16	1/4
B	4500	2450	1750	1/4	5/16
C	7000	4200	3000	5/16	1

*As indicated in previous MS specification and to be used by designer only as a guide.



Dimensions shown in inches (mm)
Specifications and dimensions subject to change

www.ittcannon.com

Contact Arrangements (Face View Pin Insert)



A

Circular

LEGEND

● Not MS Approved. ITT Cannon Proprietary (see ITT Cannon designed alternative insert positions, page A-90)

⊕ High Volume Layouts - readily available from Cannon Distributors

Shell Size	8S-1	10S-2	10SL-4	10SL-3	10SLA4	12S-4	12-5	12S-3	12SA10	14-3	14S-9
No. of Contacts	1 #16	1 #16	2 #16	3 #16	5 #20	1 #16	1 #12	2 #16	4 #16	1 #8	2 #16
Service Rating	A	A	A	A	A	D	D	A	Inst.	A	A
Shell Size	14S-1	14S-7	14S-2	14S-5	14S-6	16-7	16-12	16-11	16S-4	16-13	16-12
No. of Contacts	3 #16	3 #16	4 #16	5 #16	6 #16	2 #16 (A, B)	1 #4	2 #12	2 #16	2 #12	2 #16
Service Rating	A	A	Inst.	Inst.	Inst.	A	A	A	D	A	(A-Iron B-Constantan)
Shell Size	16S-5	16S-6	16-10	16-9	16S-8	16S-1	18-7	18-3	18-5	18-22	18-4
No. of Contacts	3 #16	3 #16	3 #12	2 #16 (B,D)	5 #16	7 #16	1 #8	2 #12	1 #16(A)	3 #16	4 #16
Service Rating	A	A	A	2 #12 (A,C)	A	A	B	D	D	D	D
Shell Size	18-10	18-13	18-15	18-11	18-12	18-9	18-8	18-1	18-19	20-2	20-23
No. of Contacts	4 #12	3 #12 (B,C,C)	4 #12	5 #12	6 #16	5 #16(B,C,E-G)	7 #16(A-G)	10 #16	10 #16	1 #0	2 #8
Service Rating	A	1 #8(A)	(A, C-Iron; B, D-Constantan)	A	A	Inst.	A	A(B,C,F,G)	A	D	A
Shell Size	20-4	20-24	20A-9	20A37	20A-48	20-14	20-8	20-17	20-22	20-15	20-4
No. of Contacts	4 #12	2 #16 (A,C)	9 #12	ITT Cannon pos.	19 #16	3 #12(C,D,E)	4 #16(B,C,E,F)	1 #16(F)	3 #16(B,D,F)	7 #12	4 #12
Service Rating	D	2 #8 (B,D)	D (J)	#8 of 20-4	D	2 #8(A,B)	2 #8(A,D)	5 #12(A-E)	3 #8(A,C,E)	A	D

Dimensions shown in inches (mm)
Specifications and dimensions subject to change

www.ittcannon.com



MS-E/F/R/ER MIL-C-5015 Connectors

Contact Arrangements (continued)



A

LEGEND

● Not MS Approved. ITT Cannon Proprietary (see ITT Cannon designed alternative insert positions, page A-90)

⊕ High Volume Layouts - readily available from Cannon Distributors

Circular

Shell Size	20-7	20-16	20-18	20-33	20-11	20-27	20-29	22-7
No. of Contacts	8 #16	7 #16(A-G) 2 #12(H,I)	6 #16(A,C-E,G,H) 3 #12(B,F,I)	11 #16	13 #16	14 #16	17 #16	1 #0
Service Rating	A(C-F) D(A,B,G,H)	A	A	A	Inst.	A	A	E
Shell Size	22-11	22-2	22-6	22-9	22-4	22-10	22-22	22-12
No. of Contacts	2 #16	3 #8	1 #16(B) 2 #8(A,C)	3 #12	2 #12(A,C) 2 #8(B,D)	4 #16	4 #8	3 #16(A,C,D) 2 #8(B,E)
Service Rating	B	D	D	E	A	E	A	D
Shell Size	22-13	22-5	22-15	22-28	22-18	22-23	22-17	22-20
No. of Contacts	1 #16(E) 4 #12(A-D)	4 #16(A,C,D,F) 2 #12(B,E)	1 #16(D) 5 #12(A-C,E,F)	7 #12	8 #16	8 #12	8 #16(A-D,F-J) 1 #12(E)	9 #16
Service Rating	A(A-D), D(E)	D	A(A-C,E,F),E(D)	A	A(C-E) D(all others)	D(H) A(all others)	D(A), A(all others)	A
Shell Size	22-27	22-19	22-14	24-9	24-22	24-12	24-2	24-10
No. of Contacts	8 #16(A-H) 1 #8(J)	14 #16	19 #16	2 #4	4 #8	3 #12(B,D,E) 2 #4(A,C)	7 #12	7 #8
Service Rating	D(J), A (all others)	A	A	A	D	A	D	A
Shell Size	24-27	24-6	24-11	24-20	24-19	24A24	24-5	24-7
No. of Contacts	7 #16	8 #12	6 #12(A-C,G-I) 3 #8(D-F)	9 #16(A-D,G-L) 2 #12(E,F)	12 #16 6 #12(B-G)	12 #12	16 #16	14 #16(A-M,O) 2 #12(P,N)
Service Rating	E	D(A,G,H) A(all others)	A	D	A	A	A	A



Dimensions shown in inches (mm)
Specifications and dimensions subject to change

www.ittcannon.com

Contact Arrangements (continued)



A

Circular

LEGEND

● Not MS Approved. ITT Cannon Proprietary (see ITT Cannon designed alternative insert positions, page A-90)

⌀ High Volume Layouts - readily available from Cannon Distributors

Shell Size 24-28	28-7	28-22	28-10	28-1	28A-16	28A-63	28-19
No. of Contacts 24 #16	2 #4	3 #16(D-F) 3 #4(A-C)	3 #12(A,F,G) 2 #8(B,E) 2 #4(C,D)	6 #12(A,B,D-F,H) 3 #8(C,J,G)	5 #16 (A, D-F, J) 4 #4 (B, C, G, H)	9 #12 19 #16	6 #16(A-C,H,L,M) 4 #12(E,G,J,K)
Service Rating Inst.	D	D	D(G), A(all others)	D(A,E,J) A(all others)	A (e) Inst. (all others)	A (e) Inst. (all others)	A(C,E,G,J,K,L) B(H,M),D(A,B)
Shell Size 28-9	28-2	28-20	28-17	28-16	28-11	28-12	
No. of Contacts 6 #16(A,H-M) 6 #12(B-G)	12 #16(A,L,N) 2 #12(M,P)	4 #16(K-N) 10 #12(A-J,P)	15 #16	20 #16	18 #16(A-I, N-X) 4 #12(J-M)	26 #16	
Service Rating D	D	A	A(A-L), B(R) D(M-P)	A	A	A	
Shell Size 28-15	28-21	28A51	32-17	32-1	32A-69	32-15	32-9
No. of Contacts 35 #16	37 #16	43 #16	4 #4	3 #12(A,C,D) 2 #0(B,E)	41 #20 20 #16	2 #0(A,G) 6 #12(B,C,D,E,F,H)	12 #16(C-N) 2 #4(A,B)
Service Rating A For MIL equip design, use 28-21	A	A	D	E(A),D(all others)	Inst.	D	D
Shell Size 32-5	32-6	32-8	32-7	32A47	32A10	36-4	
No. of Contacts 2#0	16 #16(A-O,S) 2 #12(U,V) 3 #8(P,R,T) 2 #4(W,X)	24 #16(A-L,T-Z,a-e) 6 #12(M-S) 2 #8(O,R)	28 #16(A-N,W-Z,a-k) 7 #12(O-V)	47 #16	54 #16	3 #0	
Service Rating D	A	A For new MIL equip. design, use 32-7	Inst. (A,B,h,j) A(all others)	A	A	A(B,C),C(A)	

*NOTE: Additional layouts are the same as shown but in unique alternate positions. Please consult the factory.

Dimensions shown in inches (mm)
Specifications and dimensions subject to change

www.ittcannon.com



MS-E/F/R/ER MIL-C-5015 Connectors

Contact Arrangements (continued)



A

Circular

● Not MS Approved. ITT Cannon Proprietary (see ITT Cannon designed alternative insert positions, page A-90)

⌀ High Volume Layouts - readily available from Cannon Distributors

Shell Size	36-5	36-6	36-14	36A16	36A46	36-9
No. of Contacts	4 #0	4 #4(B,C,E,F) 2 #0(A,D)	6 #16(K-N,P,Q) 5 #12(B,D,F,H,J) 5 #8(A,C,E,G,I)	18 #12 (B,C,V,J,K,M,N, R, T-Iron; A,D-F,H,L P,S,U-Constantan)	27 #12	14 #16(A-G,Z-f) 14 #12(H-N,S-Y) 2 #8(O,R) 1 #4(P)
Service Rating	A	A	D	A	A	A
Shell Size	36-15	36-7	36-8	36-10	36A34	36A66
No. of Contacts	35 #16	40 #16(A-Z,a-s) 7 #12(t-z)	46 #16(A-X,Z-z) 1 #12(Y)	48 #16	52 #16	52 #16(A-c,h-AK) 4 #12(d,e,f,g)
Service Rating	D(m), A (all others)	A	A	A	A	A
Shell Size	40A33	40-10	40A27	40-56		
No. of Contacts	7 #8(G-N) 6 #4(A-F)	16 #16(A,B,E-H,M,N,P Q,V-Y,b,c) 9 #8(C,D,I,L,O,R,U,Z,a) 4 #4(K,J,S,T)	60 #16	85 #16		
Service Rating	A	A	A	A		
Shell Size	44-1	48-5				
No. of Contacts	36 #16(A-S,Z-t) 6 #12(T-Y)	90 #16(A-BL,BN-BT,BW,BX) 1 #8(CD) 9 #12(BM,BU,BV,CC,CE)				
Service Rating	D	A				



Dimensions shown in inches (mm)
Specifications and dimensions subject to change

www.ittcannon.com

MS-E/F/R/ER MIL-C-5015 Connectors



ITT Cannon Designated Alternate Insert Positions

Not MS approved.

A

Circular

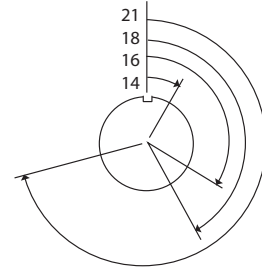
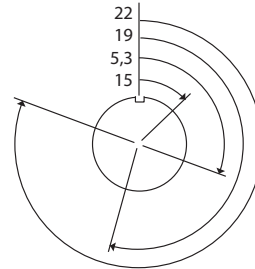
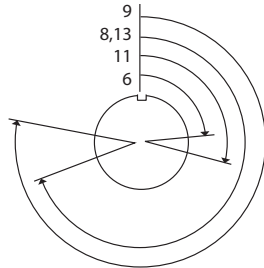
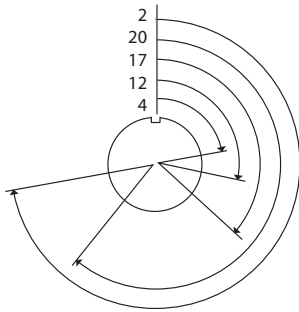

NOTE: Front view of pin insulator rotates as shown.

Shell Size	Contact Arrangement	Wire Size	Service Rating	Available Position	
20	20A-9	9#12	D (I) A (all others)		
20	20A-48	19#16	Inst.	4	9
28	28A-16	5#16 4#4	A (e) Inst (all others)	2	12
28	28A-63	9#12 19#16	A (e) Inst (all others)		
32	32A-69	41#20 20#16	Inst	3	8
		20	220		
		21	255		
		22	290		
		23	165		
		24	330		
		25	235		
		26	125		



Dimensions shown in inches (mm)
Specifications and dimensions subject to change

www.ittcannon.com

MIL-DTL-5015 Connectors MS-E/F/R

Wall Mounting Receptacle



Circular

MS3100E / MS3100F
Integral Cable Clamp



CA3100E / CA3100E

MS3100F wall mounting receptacles are used to carry wires thru walls or bulkheads, or to provide a means of disconnection at a bulkhead. MS3100F receptacles mate with 3106 and 3108 plugs. MS3100E is identical to MS3100F and is available upon request. For new equipment, customer should specify MS3100F.

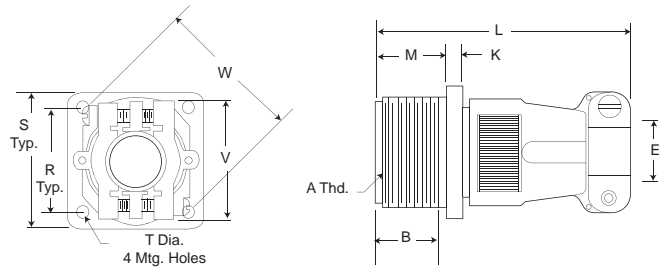

MS3100R



CA3100R

The MS3100R receptacle is identical in purpose to the MS3100F. The MS3100R features a shorter light weight endbell and mates with 3106 and 3108 plugs.

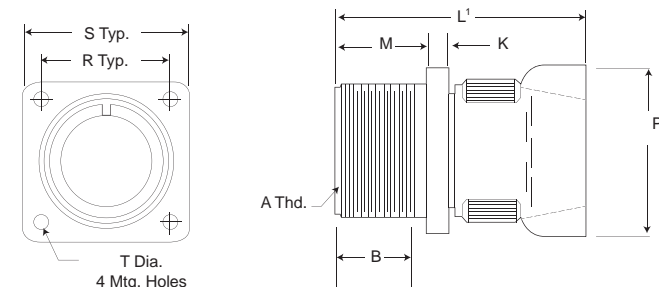

Shell Size	B Min.	E Max.	E Min.	K Max.	L Max.	L' Max.	E +.031 -0.000	P Max.	R ± .005	S ± .031	T +.010 -0.005	V Max.	W Max.
8S	.375 (9.53)	.235 (5.97)	.102 (2.59)	.125 (3.18)	2.250 (57.15)	1.838 (46.69)	.562 (14.27)	.890 (22.61)	.594 (15.09)	.875 (22.23)	.120 (3.05)	.840 (21.34)	1.046 (26.57)
10S	.375 (9.53)	.235 (5.97)	.102 (2.59)	.125 (3.18)	2.250 (57.15)	1.838 (46.69)	.562 (14.27)	.890 (22.61)	.719 (18.26)	1.000 (25.40)	.120 (3.05)	.840 (21.34)	1.046 (26.57)
10SL	.375 (9.53)	.297 (7.54)	.140 (3.56)	.125 (3.18)	2.250 (57.15)	1.838 (46.69)	.562 (14.27)	.970 (24.64)	.719 (18.26)	1.000 (25.40)	.120 (3.05)	.900 (22.86)	1.125 (28.58)
12S	.375 (9.53)	.297 (7.54)	.140 (3.56)	.140 (3.56)	2.250 (57.15)	1.838 (46.69)	.562 (14.27)	.970 (24.64)	.812 (20.62)	1.094 (27.79)	.120 (3.05)	.900 (22.86)	1.125 (28.58)
14S	.375 (9.53)	.422 (10.72)	.195 (4.95)	.140 (3.56)	2.250 (57.15)	1.838 (46.69)	.562 (14.27)	1.150 (29.21)	.906 (23.01)	1.188 (30.18)	.120 (3.05)	1.100 (27.94)	1.343 (34.11)
16S	.375 (9.53)	.547 (13.89)	.255 (6.48)	.140 (3.56)	2.250 (57.15)	1.838 (46.69)	.562 (14.27)	1.250 (31.75)	.969 (24.61)	1.281 (32.54)	.120 (3.05)	1.200 (30.48)	1.484 (37.69)
12	.625 (15.88)	.297 (7.54)	.140 (3.56)	.146 (3.71)	2.625 (66.68)	2.181 (55.40)	.750 (19.05)	.970 (24.64)	.812 (20.62)	1.094 (27.79)	.120 (3.05)	.900 (22.86)	1.125 (28.58)
14	.625 (15.88)	.422 (10.72)	.195 (4.95)	.146 (3.71)	2.625 (66.68)	2.181 (55.40)	.750 (19.05)	1.150 (29.21)	.906 (23.01)	1.188 (30.18)	.120 (3.05)	1.100 (27.94)	1.343 (34.11)
16	.625 (15.88)	.547 (13.89)	.255 (6.48)	.146 (3.71)	2.625 (66.68)	2.181 (55.40)	.750 (19.05)	1.250 (31.75)	.969 (24.61)	1.281 (32.54)	.120 (3.05)	1.200 (30.48)	1.484 (37.69)
18	.625 (15.88)	.610 (15.49)	.285 (7.24)	.180 (4.57)	2.688 (68.28)	2.181 (55.40)	.750 (19.05)	1.450 (36.83)	1.062 (26.97)	1.375 (34.93)	.120 (3.05)	1.300 (33.02)	1.609 (40.87)
20	.625 (15.88)	.735 (18.67)	.350 (8.89)	.180 (4.57)	2.750 (69.85)	2.181 (55.40)	.750 (19.05)	1.570 (39.88)	1.156 (29.36)	1.500 (38.10)	.120 (3.05)	1.500 (38.10)	1.890 (48.01)
22	.625 (15.88)	.740 (18.80)	.350 (8.89)	.180 (4.57)	2.750 (69.85)	2.181 (55.40)	.750 (19.05)	1.570 (39.88)	1.250 (31.75)	1.625 (41.28)	.120 (3.05)	1.500 (38.10)	1.890 (48.01)
24	.625 (15.88)	.922 (23.42)	.468 (11.89)	.203 (5.16)	2.969 (75.44)	2.181 (55.40)	.812 (20.62)	1.880 (47.75)	1.375 (34.93)	1.750 (44.45)	.147 (3.73)	1.740 (44.20)	2.170 (55.12)
28	.625 (15.88)	.922 (23.42)	.468 (11.89)	.203 (5.16)	3.031 (76.99)	2.181 (55.40)	.812 (20.62)	1.880 (47.75)	1.562 (39.67)	2.000 (50.80)	.147 (3.73)	1.740 (44.20)	2.170 (55.12)
32	.625 (15.88)	1.235 (31.37)	.664 (15.87)	.203 (5.16)	3.031 (76.99)	2.322 (58.98)	.875 (22.23)	2.205 (56.01)	1.750 (44.45)	2.250 (57.15)	.173 (4.39)	2.075 (52.71)	2.656 (67.46)
36	.625 (15.88)	1.360 (34.54)	.694 (17.63)	.203 (5.16)	3.281 (84.34)	2.322 (58.98)	.875 (22.23)	2.400 (60.96)	1.938 (49.23)	2.500 (63.50)	.173 (4.39)	2.300 (58.42)	2.922 (74.22)
40	.625 (15.88)	1.628 (41.35)	.911 (23.14)	.203 (5.16)	3.560 (89.66)†	2.427 (61.65)†	.875 (22.23)	2.840 (72.14)	2.188 (55.58)	2.750 (69.85)	.173 (4.39)	2.688 (68.28)	-

† Not to MS specification

Performance Specifications - Page A-84

Contact, Ceiling Plugs, Assembly Tools - Page A-105

Contact Arrangements - Page A-85 - A-89

Shell Size	A Thread
8S	1/2-28UNEF-2A
10S	5/8-24UNEF-2A
10SL	5/8-24UNEF-2A
12S	3/4-20UNEF-2A
14S	7/8-20UNEF-2A
16S	1-20UNEF-2A
12	3/4-20UNEF-2A
14	7/8-20UNEF-2A

Shell Size	A Thread
16	1-20UNEF-2A
18	1-1/8-18UNEF-2A
20	1-1/4-18UNEF-2A
22	1-3/8-18UNEF-2A
24	1-1/2-18UNEF-2A
28	1-3/4-18UNS-2A
32	2-18UNS-2A
36	2-1/4-16UN-2A
40	2-1/2-16UN-2A

Dimensions shown in inches (mm)
Specifications and dimensions subject to change

www.ittcannon.com



MIL-DTL-5015 MS-E/F/R



Cable Connecting Plug (Receptacle with no mounting flange)

Circular

MS3101E / MS3101F
Integral Cable Clamp



CA3101E / CA3101E

MS3101E cable connecting plugs are used for cable extension requirements, where mounting provisions are unnecessary.

MS3101E receptacle mate with 3106, and 3108 plugs.

Note: MIL-C-5015 has changed the nomenclature of the 3101 from Receptacle to Plug.

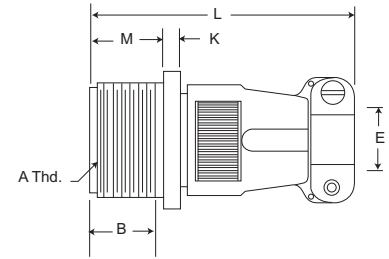
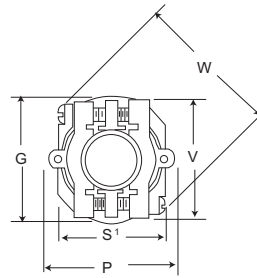

MS3101R



CA3101R

MS3101R cable connecting plug is identical in purpose to the MS3101E. The MS3101R features a shorter light weight endbell and mates with 3106, and 3108 plugs.

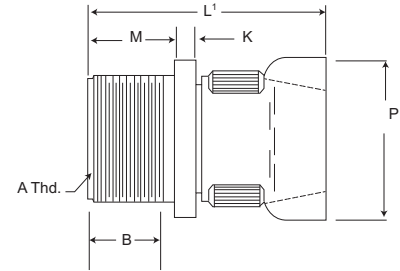
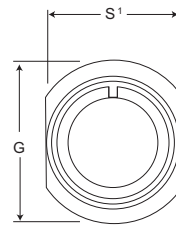

Shell Size	B Min.	E Max.	E Min.	G Max.	K Max.	L Max.	L' Max.	M		P Max.	S' Max.	V Max.	W Max.
								+0.031 (0.79)	-0.000 (0.00)				
8S	.375 (9.53)	.235 (5.97)	.102 (2.59)	.844 (21.44)	.125 (3.18)	2.250 (57.15)	1.838 (46.69)	.562 (14.27)	.890 (22.61)	.515 (13.08)	.840 (21.34)	1.046 (26.57)	
10S	.375 (9.53)	.235 (5.97)	.102 (2.59)	.969 (24.61)	.125 (3.18)	2.250 (57.15)	1.838 (46.69)	.562 (14.27)	.890 (22.61)	.640 (16.26)	.840 (21.34)	1.046 (26.57)	
10SL	.375 (9.53)	.297 (7.54)	.140 (3.56)	1.062 (26.97)	.125 (3.18)	2.250 (57.15)	1.838 (46.69)	.562 (14.27)	.970 (24.64)	.640 (16.26)	.900 (22.86)	1.125 (28.58)	
12S	.375 (9.53)	.297 (7.54)	.140 (3.56)	1.062 (26.97)	.140 (3.56)	2.250 (57.15)	1.838 (46.69)	.562 (14.27)	.970 (24.64)	.765 (19.43)	.900 (22.86)	1.125 (28.58)	
14S	.375 (9.53)	.422 (10.72)	.195 (4.95)	1.156 (29.36)	.140 (3.56)	2.250 (57.15)	1.838 (46.69)	.562 (14.27)	1.150 (29.21)	.890 (22.61)	1.100 (27.94)	1.343 (34.11)	
16S	.375 (9.53)	.547 (13.89)	.255 (6.48)	1.281 (32.54)	.140 (3.56)	2.250 (57.15)	1.838 (46.69)	.562 (14.27)	1.250 (31.75)	1.015 (25.78)	1.200 (30.48)	1.484 (37.69)	
12	.625 (15.88)	.297 (7.54)	.140 (3.56)	1.062 (26.97)	.146 (3.71)	2.625 (66.68)	2.181 (55.40)	.750 (19.05)	.970 (24.64)	.765 (19.43)	.900 (22.86)	1.125 (28.58)	
14	.625 (15.88)	.422 (10.72)	.195 (4.95)	1.156 (29.36)	.146 (3.71)	2.625 (66.68)	2.181 (55.40)	.750 (19.05)	1.150 (29.21)	.890 (22.61)	1.100 (27.94)	1.343 (34.11)	
16	.625 (15.88)	.547 (13.89)	.255 (6.48)	1.281 (32.54)	.146 (3.71)	2.625 (66.68)	2.181 (55.40)	.750 (19.05)	1.250 (31.75)	1.015 (25.78)	1.200 (30.48)	1.484 (37.69)	
18	.625 (15.88)	.610 (15.49)	.285 (7.24)	1.344 (34.14)	.180 (4.57)	2.688 (68.28)	2.181 (55.40)	.750 (19.05)	1.450 (36.83)	1.140 (28.96)	1.300 (33.02)	1.609 (40.87)	
20	.625 (15.88)	.735 (18.67)	.350 (8.89)	1.500 (38.10)	.180 (4.57)	2.750 (69.85)	2.181 (55.40)	.750 (19.05)	1.570 (39.88)	1.265 (32.13)	1.500 (38.10)	1.890 (48.01)	
22	.625 (15.88)	.740 (18.80)	.350 (8.89)	1.625 (41.28)	.180 (4.57)	2.750 (69.85)	2.181 (55.40)	.750 (19.05)	1.570 (39.88)	1.390 (35.31)	1.500 (38.10)	1.890 (48.01)	
24	.625 (15.88)	.922 (23.42)	.468 (11.89)	1.750 (44.45)	.203 (5.16)	2.969 (75.44)	2.181 (55.40)	.812 (20.62)	1.880 (47.75)	1.515 (38.48)	1.740 (44.20)	2.170 (55.12)	
28	.625 (15.88)	.922 (23.42)	.468 (11.89)	2.000 (50.80)	.203 (5.16)	3.031 (76.99)	2.181 (55.40)	.812 (20.62)	1.880 (47.75)	1.765 (44.83)	1.740 (44.20)	2.170 (55.12)	
32	.625 (15.88)	1.235 (31.37)	.664 (15.87)	2.250 (57.15)	.203 (5.16)	3.031 (76.99)	2.322 (58.98)	.875 (22.23)	2.205 (56.01)	2.015 (51.18)	2.075 (52.71)	2.656 (67.46)	
36	.625 (15.88)	1.360 (34.54)	.694 (17.63)	2.500 (63.50)	.203 (5.16)	3.281 (84.34)	2.322 (58.98)	.875 (22.23)	2.400 (60.96)	2.270 (57.66)	2.300 (58.42)	2.922 (74.22)	
40	.625 (15.88)	1.628 (41.35)	.911 (23.14)	2.750 (69.85)	.203 (5.16)	3.560 (89.66)†	2.427 (61.65)†	.875 (22.23)	2.840 (72.14)	2.427 (61.65)	2.688 (68.28)	-	

† Not to MS specification

Shell Size	A Thread
8S	1/2-28UNEF-2A
10S	5/8-24UNEF-2A
10SL	5/8-24UNEF-2A
12S	3/4-20UNEF-2A
14S	7/8-20UNEF-2A
16S	1-20UNEF-2A
12	3/4-20UNEF-2A
14	7/8-20UNEF-2A

Shell Size	A Thread
16	1-20UNEF-2A
18	1-1/8-18UNEF-2A
20	1-1/4-18UNEF-2A
22	1-3/8-18UNEF-2A
24	1-1/2-18UNEF-2A
28	1-3/4-18UNEF-2A
32	2-18UNEF-2A
36	2-1/4-16UN-2A
40	2-1/2-16UN-2A

Performance Specifications - Page A-84

Contact, Ceiling Plugs, Assembly Tools - Page A-105

Contact Arrangements - Page A-85 - A-89



Dimensions shown in inches (mm)
Specifications and dimensions subject to change

www.ittcannon.com

MIL-DTL-5015 Connectors MS-E/F/R

Box Mounting Receptacle

MS3102E / MS3102R

CA3102E / CA3102R



Shell Size	X DIMENSION				
	Max. Solder Pot Ext. - Pin or Socket				
	Contact Size				
8S, 10S, 10SL	.534	-	-	-	-
12S, 14S, 16S	.518	-	-	-	-
12	.705	.705	-	-	-
14	.705	.705	.767	-	-
16	.705	.705	.767	.767	-
18	.674	.674	.736	.736	-
20, 22	.674	.674	.736	.736	.971
24, 28	.612	.612	.674	.674	.909
32, 36	.549	.549	.611	.611	.846

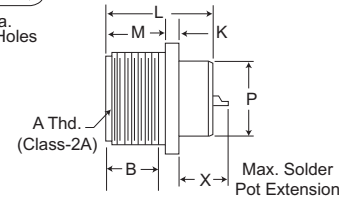
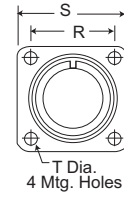

MS3102E and MS3102R box mounting receptacles are used in junction boxes or as an integral part of equipment. These connectors are identical in construction and will mate with 3106 and 3108 plugs. For new equipment, customers should specify MS3102R.



A

Circular

Straight Plug

MS3106E / MS3106F

CA3106E / CA3106E

MS3106F straight plugs mate with 3100, 3102 and 3102 receptacles.



MS3106E is available upon request. For new equipment, customer should specify MS3106F. MS3106E is identical to MS3106F except to O-ring under the coupling nut.

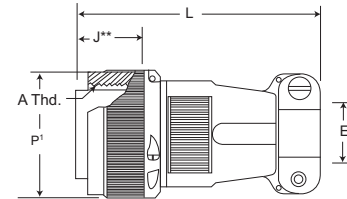
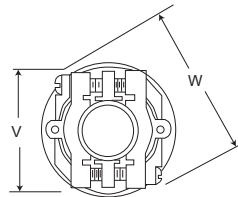

MS3106R

CA3106R

MS3106R straight plug is identical in purpose to the MS3106F. The MS3106R has the shorter endbell. This plug will mate with 3100, 3101, and 3102 receptacles.

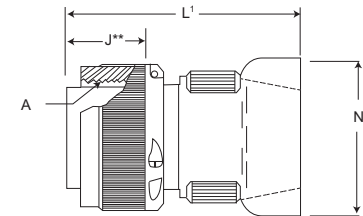
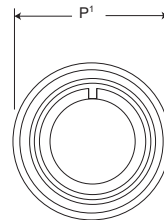

Shell Size	E Max.	E Min.	J** Max.	L Max.	L' Max.	N Max.	P' Max.	V Max.	W Max.
8S	.235 (5.97)	.102 (2.59)	.536 (13.61)	2.250 (57.15)	1.838 (46.69)	.890 (22.61)	.844 (21.44)	.840 (21.34)	1.046 (26.57)
10S	.235 (5.97)	.102 (2.59)	.536 (13.61)	2.250 (57.15)	1.838 (46.69)	.890 (22.61)	.969 (24.61)	.840 (21.34)	1.046 (26.57)
10SL	.297 (7.54)	.140 (3.56)	.536 (13.61)	2.250 (57.15)	1.838 (46.69)	.970 (24.64)	.969 (24.61)	.900 (22.86)	1.125 (28.58)
12S	.297 (7.54)	.140 (3.56)	.536 (13.61)	2.250 (57.15)	1.838 (46.69)	.970 (24.64)	1.062 (26.97)	.900 (22.86)	1.125 (28.58)
14S	.422 (10.72)	.195 (4.95)	.536 (13.61)	2.250 (57.15)	1.838 (46.69)	1.150 (29.21)	1.156 (29.36)	1.100 (27.94)	1.343 (34.11)
16S	.547 (13.89)	.255 (6.48)	.536 (13.61)	2.250 (57.15)	1.838 (46.69)	1.250 (31.75)	1.250 (31.75)	1.200 (30.48)	1.484 (37.69)
12	.297 (7.54)	.140 (3.56)	.724 (18.39)	2.625 (66.68)	2.181 (55.40)	.970 (24.64)	1.062 (26.97)	.900 (22.86)	1.125 (28.58)
14	.422 (10.72)	.195 (4.95)	.724 (18.39)	2.625 (66.68)	2.181 (55.40)	1.150 (29.21)	1.156 (29.36)	1.100 (27.94)	1.343 (34.11)
16	.547 (13.89)	.255 (6.48)	.724 (18.39)	2.625 (66.68)	2.181 (55.40)	1.250 (31.75)	1.250 (31.75)	1.200 (30.48)	1.484 (37.69)
18	.610 (15.49)	.285 (7.24)	.724 (18.39)	2.688 (68.28)	2.181 (55.40)	1.450 (36.83)	1.344 (34.14)	1.300 (33.02)	1.609 (40.87)
20	.735 (18.67)	.350 (8.89)	.724 (18.39)	2.750 (69.85)	2.181 (55.40)	1.570 (39.88)	1.469 (37.31)	1.500 (38.10)	1.890 (48.01)
22	.740 (18.80)	.350 (8.89)	.724 (18.39)	2.750 (69.85)	2.181 (55.40)	1.570 (39.88)	1.594 (40.49)	1.500 (38.10)	1.890 (48.01)
24	.922 (23.42)	.468 (11.89)	.724 (18.39)	2.969 (75.44)	2.181 (55.40)	1.880 (47.75)	1.719 (43.66)	1.740 (44.20)	2.170 (55.12)
28	.922 (23.42)	.468 (11.89)	.724 (18.39)	3.031 (76.99)	2.181 (55.40)	1.880 (47.75)	1.969 (50.01)	1.740 (44.20)	2.170 (55.12)
32	1.235 (31.37)	.664 (15.87)	.724 (18.39)	3.031 (76.99)	2.322 (58.98)	2.205 (56.01)	2.219 (56.36)	2.075 (52.71)	2.656 (67.46)
36	1.360 (34.54)	.694 (17.63)	.724 (18.39)	3.281 (84.34)	2.322 (58.98)	2.400 (60.96)	2.469 (62.71)	2.300 (58.42)	2.922 (74.22)
40	1.628 (41.35)	.911 (23.14)	.724 (18.39)	3.560 (89.66)†	2.427 (61.65)†	2.840 (72.14)	2.723 (69.16)†	2.688 (68.28)	-

† Not to MS specification

Dimensions shown in inches (mm)

Specifications and dimensions subject to change

www.ittcannon.com



MIL-DTL-5015 Connectors MS-E/F/R



A

Circular

Performance Specifications - Page A-84
Contact, Ceiling Plugs, Assembly Tools - Page A-105
Contact Arrangements - Page A-85 – A-89

Straight Plug (continued)

Shell Size	A Thread	Shell Size	A Thread
8S	1/2-28UNEF-2A	16	1-20UNEF-2A
10S	5/8-24UNEF-2A	18	1-1/8-18UNEF-2A
10SL	5/8-24UNEF-2A	20	1-1/4-18UNEF-2A
12S	3/4-20UNEF-2A	22	1-3/8-18UNEF-2A
14S	7/8-20UNEF-2A	24	1-1/2-18UNEF-2A
16S	1-20UNEF-2A	28	1-3/4-18UNS-2A
12	3/4-20UNEF-2A	32	2-18UNS-2A
14	7/8-20UNEF-2A	36	2-1/4-16UN-2A
		40	2-1/2-16UN-2A

90° Angle Plug

MS3108E / MS3108R

CA3108E / CA3108R



MS3108R 90° angle plugs with O-ring seal (less cable clamp) and the MS3108E 90° angle plugs (less O-ring seal with cable clamp) are used where there is limited space and where wires must be brought at abrupt angles. These plugs will mate with 3100, 3101 and 3102 receptacles.

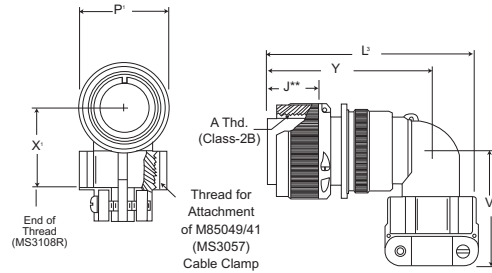

Shell Size	B Min.	J**		K Max.	L Max.	L ³ Max.	M		P Max.	P ¹ Max.	R ± .005	S ± .031	T		V ¹ Max.	X ¹ Max.	Y Max.
		Min.	Max.				+ .031 (0.79)	- .000 (0.00)					+ .010	- .005			
8S	.375 (9.53)	.536 (13.61)	.125 (3.18)	.125 (3.18)	1.040 (26.42)	2.156 (54.76)	.562 (14.27)	.426 (10.86)	.844 (21.44)	.594 (15.09)	.875 (22.23)	.120 (3.05)	1.281 (30.94)	.811 (20.60)	1.640 (41.66)		
10S	.375 (9.53)	.536 (13.61)	.125 (3.18)	.125 (3.18)	1.040 (26.42)	2.156 (54.76)	.562 (14.27)	.520 (13.21)	.969 (24.61)	.719 (18.26)	1.000 (25.40)	.120 (3.05)	1.250 (31.75)	.842 (21.39)	1.640 (41.66)		
10SL	.375 (9.53)	.536 (13.61)	.125 (3.18)	.125 (3.18)	1.040 (26.42)	2.188 (55.58)	.562 (14.27)	.614 (15.60)	.969 (24.61)	.719 (18.26)	1.000 (25.40)	.120 (3.05)	1.281 (32.54)	.873 (22.17)	1.703 (43.26)		
12S	.375 (9.53)	.536 (13.61)	.140 (3.56)	.140 (3.56)	1.040 (26.42)	2.188 (55.58)	.562 (14.27)	.614 (15.60)	1.062 (26.97)	.812 (20.62)	1.094 (27.79)	.120 (3.05)	1.281 (32.54)	.873 (22.17)	1.703 (43.26)		
14S	.375 (9.53)	.536 (13.61)	.140 (3.56)	.140 (3.56)	1.040 (26.42)	2.312 (58.72)	.562 (14.27)	.739 (18.77)	1.156 (29.36)	.906 (23.01)	1.188 (30.18)	.120 (3.05)	1.406 (35.71)	.936 (23.77)	1.765 (44.83)		
16S	.375 (9.53)	.536 (13.61)	.140 (3.56)	.140 (3.56)	1.040 (26.42)	2.406 (61.11)	.562 (14.27)	.664 (21.95)	1.250 (31.75)	.969 (24.61)	1.281 (32.54)	.120 (3.05)	1.531 (38.89)	.998 (25.35)	1.796 (45.62)		
12	.625 (15.88)	.724 (18.39)	.146 (3.71)	.146 (3.71)	1.400 (35.56)	2.531 (64.29)	.750 (19.05)	.614 (15.60)	1.062 (26.97)	.812 (20.62)	1.094 (27.79)	.120 (3.05)	1.281 (32.54)	.873 (22.17)	2.062 (52.37)		
14	.625 (15.88)	.724 (18.39)	.146 (3.71)	.146 (3.71)	1.400 (35.56)	2.688 (68.28)	.750 (19.05)	.739 (18.77)	1.156 (29.36)	.906 (23.01)	1.188 (30.18)	.120 (3.05)	1.406 (35.71)	.936 (23.77)	2.125 (53.98)		
16	.625 (15.88)	.724 (18.39)	.146 (3.71)	.146 (3.71)	1.400 (35.56)	2.781 (70.64)	.750 (19.05)	.864 (21.95)	1.250 (31.75)	.969 (24.61)	1.281 (32.54)	.120 (3.05)	1.531 (38.89)	.998 (25.35)	2.156 (54.76)		
18	.625 (15.88)	.724 (18.39)	.180 (4.57)	.180 (4.57)	1.400 (35.56)	2.844 (72.24)	.750 (19.05)	.989 (25.12)	1.344 (34.14)	1.062 (26.97)	1.375 (34.93)	.120 (3.05)	1.593 (40.46)	1.061 (26.95)	2.250 (57.15)		
20	.625 (15.88)	.724 (18.39)	.180 (4.57)	.180 (4.57)	1.400 (35.56)	3.250 (82.55)	.750 (19.05)	1.145 (29.08)	1.469 (37.31)	1.156 (29.36)	1.500 (38.10)	.120 (3.05)	1.656 (42.06)	1.123 (28.52)	2.312 (58.72)		
22	.625 (15.88)	.724 (18.39)	.180 (4.57)	.180 (4.57)	1.400 (35.56)	3.250 (82.55)	.750 (19.05)	1.270 (32.26)	1.594 (40.49)	1.250 (31.75)	1.625 (41.28)	.120 (3.05)	1.718 (43.64)	1.186 (30.12)	2.312 (58.72)		
24	.625 (15.88)	.724 (18.39)	.203 (5.16)	.203 (5.16)	1.400 (35.56)	3.719 (94.46)	.812 (20.62)	1.395 (35.43)	1.719 (43.66)	1.375 (34.93)	1.750 (44.45)	.147 (3.73)	1.890 (48.01)	1.263 (32.08)	2.531 (64.29)		
28	.625 (15.88)	.724 (18.39)	.203 (5.16)	.203 (5.16)	1.400 (35.56)	3.719 (94.46)	.812 (20.62)	1.614 (41.00)	1.969 (50.01)	1.562 (39.67)	2.000 (50.80)	.147 (3.73)	1.968 (49.99)	1.342 (34.09)	2.531 (64.29)		
32	.625 (15.88)	.724 (18.39)	.203 (5.16)	.203 (5.16)	1.400 (35.56)	4.188 (106.38)	.875 (22.23)	1.864 (47.35)	2.219 (56.36)	1.750 (44.45)	2.250 (57.15)	.173 (4.39)	2.187 (55.55)	1.561 (39.65)	2.750 (69.85)		
36	.625 (15.88)	.724 (18.39)	.203 (5.16)	.203 (5.16)	1.400 (35.56)	4.297 (109.14)	.875 (22.23)	2.051 (52.10)	2.469 (62.71)	1.938 (49.23)	2.500 (63.50)	.173 (4.39)	2.406 (61.11)	1.780 (45.21)	2.875 (73.02)		
40	.625 (15.88)	.724 (18.39)	.203 (5.16)	.203 (5.16)	1.400 (35.56)	7.211 (183.16)†	.875 (22.23)	2.390 (60.71)	2.723 (69.16)†	2.188 (55.58)	2.750 (69.85)	.173 (4.39)	5.875 (149.22)	-	5.690 (144.53)		

† Not to MS specification

Shell Size	A Thread		Shell Size	A Thread	
	Box Mounting Receptacle	90° Angle Plug		Box Mounting Receptacle	90° Angle Plug
8S	1/2-28UNEF-2A	1/2-28UNEF-2B	16	1-20UNEF-2A	1-20UNEF-2B
10S	5/8-24UNEF-2A	5/8-24UNEF-2B	18	1-1/8-18UNEF-2A	1-1/8-18UNEF-2B
10SL	5/8-24UNEF-2A	5/8-24UNEF-2B	20	1-1/4-18UNEF-2A	1-1/4-18UNEF-2B
12S	3/4-20UNEF-2A	3/4-20UNEF-2B	22	1-3/8-18UNEF-2A	1-3/8-18UNEF-2B
14S	7/8-20UNEF-2A	7/8-20UNEF-2B	24	1-1/2-18UNEF-2A	1-1/2-18UNEF-2B
16S	1-20UNEF-2A	1-20UNEF-2B	28	1-3/4-18UNS-2A	1-3/4-18UNS-2B
12	3/4-20UNEF-2A	3/4-20UNEF-2B	32	2-18UNS-2A	2-18UNS-2B
14	7/8-20UNEF-2A	7/8-20UNEF-2B	36	2-1/4-16UN-2A	2-1/4-16UN-2B
			40	2-1/2-16UN-2A	2-1/2-16UN-2B

Performance Specifications - Page A-84
Contact, Ceiling Plugs, Assembly Tools - Page A-105
Contact Arrangements - Page A-85 – A-89



Dimensions shown in inches (mm)
Specifications and dimensions subject to change

www.ittcannon.com

MIL-DTL-5015 Connectors MS-E/F/R

Components



A

Circular

MS3106R CA3106R Straight Plug	MS3106F CA06R Straight Plug	MS3106E* CA3106E Straight Plug	MS3108E CA3108E 90° Angle Plug	MS3108R CA3108R 90° Angle Plug
-------------------------------------	-----------------------------------	--------------------------------------	--------------------------------------	--------------------------------------

Endbell

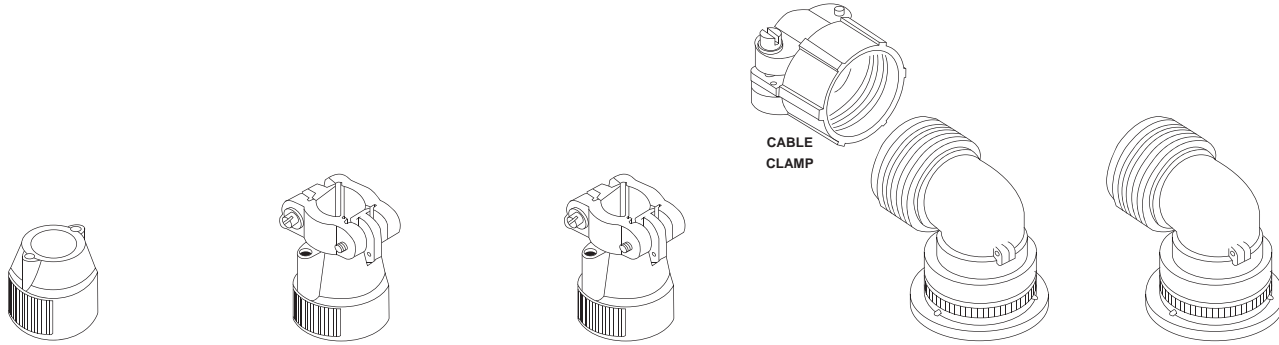

Ferrule



Grommet

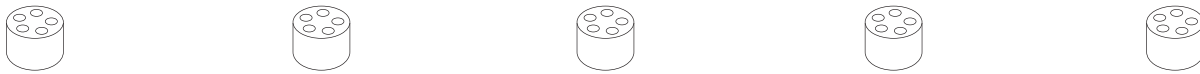

Pin Contacts

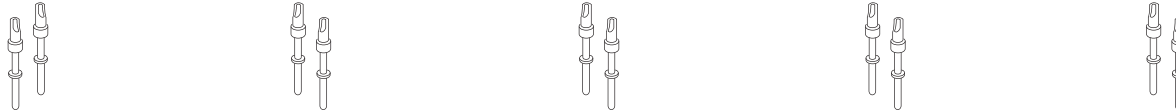

Insulator



Coupling Nut

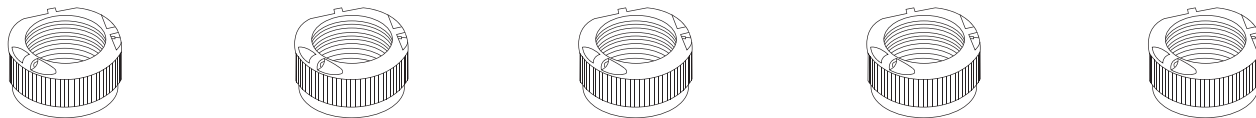

Barrel

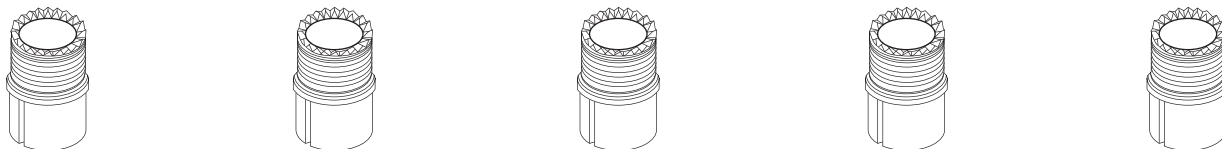

O Ring



Note: Class F is not applicable to MS3108 shell style.

* Class E inactive for new design. Use Class F or R.

Dimensions shown in inches (mm)
Specifications and dimensions subject to change

www.ittcannon.com



MIL-DTL-5015 Connectors MS-E/F/R



A

Circular

MS type potting connectors are available with nylon cups. 00 and 06 shell styles with plastic cups and resilient insulators meet the requirements of MS3103 and MS25183. Also available is the 08 plug with resilient insulator and 90° angle nylon potting cup.

ITT Cannon provides for a 1/4" clearance for potting on all contact sizes.



How To Order

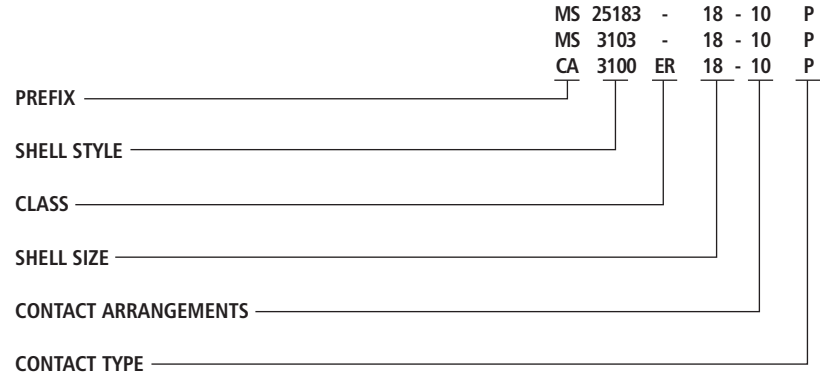

PREFIX
CA - ITT Cannon prefix indicating special application or variation of MS

SHELL STYLE
3100 - Wall mounting receptacle (MS3103)
3106 - Straight Plug (MS325183)
3108 - 90° angle plug

CLASS
ER - Resilient insulator, nylon potting cup and thread attachment ring
No class designator for MS types.

SHELL STYLE
Coupling thread diameter figured in sixteenths of an inch

CONTACT ARRANGEMENTS
See pages A-85 – A-89

CONTACT TYPE
P - Pin
S - Socket

Wall Mounting Receptacle

MS3103
Nylon Potting Cup
Threaded Attachment Ring

CA3100ER

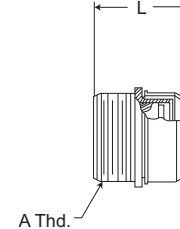
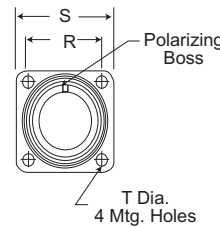

The CA3100ER receptacle (MS3103) is supplied with a resilient insulator and nylon potting cup with a threaded attachment ring. This receptacle mates with 3106 and 3108 plugs.

Shell Size	L Max.	R ± .005 (±0.13)	S Max.	R		A Thread
				+ .010 (+0.25)	-.005 (-.031)	
8S	1.531 (38.89)	.594 (15.09)	.906 (23.01)	.120 (3.05)		1/2-28UNEF-2A
10S	1.531 (38.89)	.719 (18.26)	1.031 (26.19)	.120 (3.05)		5/8-24NEF-2A
10SL	1.531 (38.89)	.719 (18.26)	1.031 (26.19)	.120 (3.05)		5/8-24NEF-2A
12S	1.531 (38.89)	.812 (20.62)	1.125 (28.58)	.120 (3.05)		3/4-20UNEF-2A
14S	1.531 (38.89)	.906 (23.01)	1.219 (30.96)	.120 (3.05)		7/8-20UNEF-2A
16S	1.531 (38.89)	.969 (24.61)	1.312 (33.32)	.120 (3.05)		1-20UNEF-2A
12	1.968 (49.99)	.812 (20.62)	1.125 (28.58)	.120 (3.05)		3/4-20UNEF-2A
14	1.968 (49.99)	.906 (23.01)	1.219 (30.96)	.120 (3.05)		3/4-20UNEF-2A
16	1.968 (49.99)	.969 (24.61)	1.312 (33.32)	.120 (3.05)		1-20UNEF-2A
18	1.968 (49.99)	1.062 (26.97)	1.406 (35.71)	.120 (3.05)		1-1/8-18NEF-2A
20	2.188 (55.58)	1.156 (29.36)	1.531 (38.89)	.120 (3.05)		1-1/4-18NEF-2A
22	2.188 (55.58)	1.250 (31.75)	1.656 (42.06)	.120 (3.05)		1-3/8-18NEF-2A
24	2.188 (55.58)	1.375 (34.93)	1.781 (45.24)	.147 (3.73)		1-1/2-18NEF-2A
28	2.188 (55.58)	1.562 (39.67)	2.031 (51.59)	.147 (3.73)		1-3/4-18NS-2A
32	2.188 (55.58)	1.750 (44.45)	2.281 (57.94)	.173 (4.39)		2-18NS-2A
36	2.188 (55.58)	1.938 (49.23)	2.531 (64.29)	.173 (4.39)		2-1/4-16UN-2A

Performance Specifications - Page A-84

Contact, Ceiling Plugs, Assembly Tools - Page A-105

Contact Arrangements - Page A-85 – A-89



Dimensions shown in inches (mm)
Specifications and dimensions subject to change

www.ittcannon.com

MIL-DTL-5015 Connectors MS-E/F/R

Straight Plug

MS25183
Nylon Potting Cup
Rubber Gasket

CA3106ER

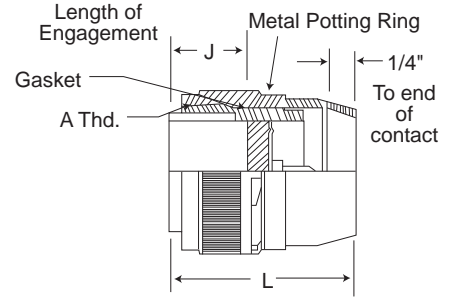
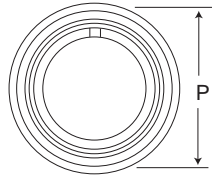

The CA3106ER plug is supplied with resilient insulators, nylon potting cups with threaded attachment rings, and a rubber gasket under the coupling nut. This plug mates with 3100, 3101 and 3102 receptacles.



A

Circular

90° Angle Plug

Nylon Potting Cup
Rubber Gasket

CA3108ER

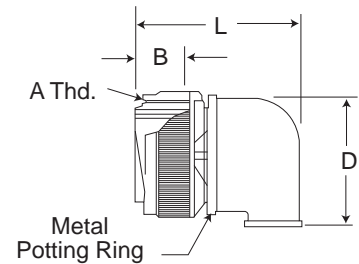
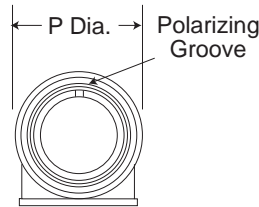

The CA3108ER is supplied with resilient insulator, 90° nylon potting cup and threaded attachment ring with a rubber gasket under the coupling nut. This plug mates with 3100, 3101 and 3102 receptacles.

CA3106ER					CA3108ER					
Shell Size	J Max.	L Max.	P Max.	A Thread	B Max.	D Max.	L Max. For Arr. w/#16  Contacts	For Arr. w/#8 Contacts	P Max.	A Thread
8S	.536 (13.61)	1.562 (39.67)	.844 (21.44)	1/2-28UNEF-2B	-	-	-	-	-	-
10S	.536 (13.61)	1.562 (39.67)	.969 (21.44)	5/8-24UNEF-2B	-	-	-	-	-	-
10SL	.536 (13.61)	1.562 (39.67)	.969 (21.44)	5/8-24UNEF-2B	.563(13.61)	1.040(26.42)	1.463(37.16)	-	969(24.61)	5/8-24UNEF-2B
12S	.536 (13.61)	1.562 (39.67)	1.062 (21.44)	3/4-20UNEF-2B	.563(13.61)	1.040(26.42)	1.600(40.64)	-	1.062(26.97)	3/4-24UNEF-2B
14S	.536 (13.61)	1.562 (39.67)	1.156 (21.44)	7/8-20UNEF-2B	.563(13.61)	1.040(26.42)	1.600(40.64)	2.300(58.42)	1.156(29.36)	7/8-20UNEF-2B
16S	.536 (13.61)	1.562 (39.67)	1.250 (21.44)	1-20UNEF-2B	.563(13.61)	1.290(32.77)	1.600(40.64)	2.550(64.77)	1.250(31.75)	1-20UNEF-2B
12	.724 (18.39)	2.000 (50.80)	1.062 (26.97)	3/4-20UNEF-2B	.724(18.39)	1.040(26.42)	1.910(48.51)	-	1.062(26.97)	3/4-20UNEF-2B
14	.724 (18.39)	2.000 (50.80)	1.156 (29.36)	7/8-20UNEF-2B	.724(18.39)	1.040(26.42)	1.910(48.51)	2.610(66.29)	1.156(29.36)	7/8-20UNEF-2B
16	.724 (18.39)	2.000 (50.80)	1.250 (31.75)	1-20UNEF-2B	.724(18.39)	1.290(32.77)	1.910(48.51)	2.850(72.39)	1.250(31.75)	1-20UNEF-2B
18	.724 (18.39)	2.000 (50.80)	1.344 (34.14)	1-1/8-18UNEF-2B	.724(18.39)	1.290(32.77)	2.100(53.34)	2.850(72.39)	1.344(34.14)	1-1/8-18UNEF-2B
20	.724 (18.39)	2.125 (53.98)	1.469 (37.31)	1-1/4-18UNEF-2B	.724(18.39)	1.540(39.12)	2.100(53.34)	2.850(72.39)	1.469(37.31)	1-1/4-18UNEF-2B
22	.724 (18.39)	2.125 (53.98)	1.594 (40.49)	1-3/8-18UNEF-2B	.724(18.39)	1.540(39.12)	2.100(53.34)	2.850(72.39)	1.594(40.49)	1-3/8-18UNEF-2B
24	.724 (18.39)	2.125 (53.98)	1.719 (43.66)	1-1/2-18UNEF-2B	.724(18.39)	1.790(45.47)	2.281(57.94)	2.985(75.82)	1.719(43.66)	1-1/2-18UNEF-2B
28	.724 (18.39)	2.125 (53.98)	1.969 (50.01)	1-3/4-18UNS-2B	.724(18.39)	2.040(51.82)	2.485(63.12)	2.985(75.82)	1.969(50.01)	1-3/4-18UNS-2B
32	.724 (18.39)	2.180 (55.37)	1.219 (30.96)	2-18UNS-2B	.724(18.39)	2.290(58.17)	2.485(63.12)	2.985(75.82)	1.219(30.96)	2-18UNS-2B
36	.724 (18.39)	2.180 (55.37)	2.469 (62.71)	2-1/4-16UN-2B	.724(18.39)	2.540(64.52)	2.485(63.12)	2.985(75.82)	2.469(62.71)	2-1/4-16UN-2B
40	.724 (18.39)	2.180 (55.37)	2.723 (69.16)	2-1/2-16UN-2B	.724(18.39)	2.540(64.52)	2.485(63.12)	2.985(75.82)	2.469(62.71)	2-1/4-16UN-2B

Performance Specifications - Page A-84

Contact, Ceiling Plugs, Assembly Tools - Page A-105

Contact Arrangements - Page A-85 - A-89

Dimensions shown in inches (mm)
Specifications and dimensions subject to change

www.ittcannon.com



MIL-DTL-5015 Connectors MS



A

Circular



Straight Plug with Shrink Boot Adapter

CA3106E-DN

CA3106E-DN is a straight plug with endbell for shrink boot adapters. Crimp and solder versions are available (please indicate ...F80 or ...F183). CA3106-DN mate with 3100, 3101 and 3102 shell styles.

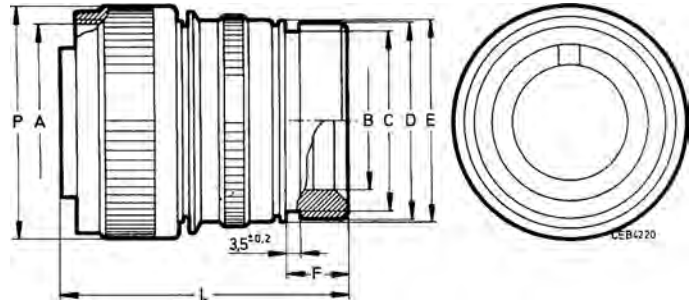

Order reference	A	B	C	D	E	F	L	P
Pin insert*	Thread	min.	max.	±0.2	±0,2	0,5	max.	max.
CA3106E10SL-**-P-DN	5/8-24NEF-2B	7,7	13,2	15,5	17,0	11,7	11,7	50,0
CA3106E12S-**-P-DN	3/4-20UNEF-2B	7,9	13,2	15,5	17,8	11,8	58,8	25,6
CA3106E14S-**-P-DN	7/8-20UNEF-2B	10,6	17,0	19,1	19,1	11,7	50,0	28,6
CA3106E16S-**-P-DN	1-20UNEF-2B	13,5	21,9	23,9	23,9	11,5	50,0	31,8
CA3106E12-**-P-DN	3/4-20UNEF-2B	7,9	13,2	15,5	17,8	11,7	50,0	25,6
CA3106E14-**-P-DN	7/8-20UNEF-2B	10,6	17,0	19,1	20,1	11,7	60,0	28,6
CA3106E16-**-P-DN	1-20UNEF-2B	13,5	21,9	23,9	23,5	11,5	60,0	31,8
CA3106E18-**-P-DN	1-1/8-18NEF-2B	14,6	21,9	23,9	26,5	12,7	60,0	34,1
CA3106E20-**-P-DN	1-1/4-18NEF-2B	18,5	26,6	29,6	30,2	12,7	65,0	37,3
CA3106E22-**-P-DN	1-3/8-18NEF-2B	20,8	26,2	29,6	33,6	12,7	65,0	40,5
CA3106E24-**-P-DN	1-1/2-16NEF-2B	24,6	34,5	37,8	36,1	12,7	65,0	43,8
CA3106E28-**-P-DN	1-3/4-18NS-2B	27,0	34,5	37,8	41,4	12,7	65,0	50,0
CA3106E32-**-P-DN	2-18NS-2B	33,3	43,6	47,8	48,6	15,2	70,0	56,3
CA3106E36-**-P-DN	2-1/4-16UN-2B	38,5	43,6	47,8	54,8	15,2	80,0	62,7

*For socket inserts substitute S for P

**Add contact arrangement number (see pages A-85 – A-89)



MIL-DTL-5015 Bulkhead Receptacles BFR/TBF

How To Order

TBF and BFR pressurized bulkhead receptacles mate with standard MS type plugs (3106 and 3108) if contact arrangements correspond. Both the BFR and TBF have resilient insulators. The TBF (thru bulkhead fitting) version has a double faced construction allowing mating from both ends. An O-ring is supplied as standard on both the BFR and TBF. Contacts are silver plated copper or brass alloy. Shells are aluminum alloy.

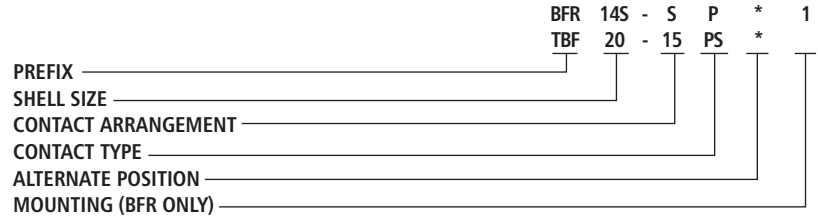

PREFIX
BFR - Bulkhead fittings
TBF - Thru bulkhead fittings

SHELL SIZE
Coupling thread diameter figured in sixteenths of an inch.

CONTACT ARRANGEMENTS
See pages A-85 – A-89

CONTACT TYPE
P - Pin; S - Socket;
PS - pin and socket (TBF only)

ALTERNATE POSITION
(Consult factory for available alternate positions.)

MOUNTING
-1 obligatory code, BFR only



A

Circular

Thru-Bulkhead Receptacle

TBF - Resilient Insulator



Pin Insert Ends



Socket Insert Ends

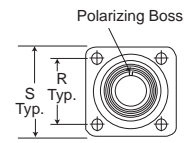
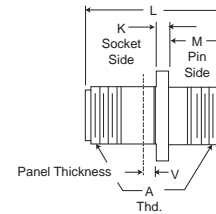
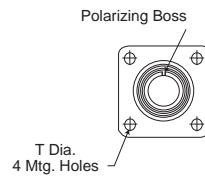

TBF thru-bulkhead fittings have pressurized resilient insulators. Special double-faced pin and socket contact construction permits cable components to be wired and tested in the shop and then to be plugged into the mounted TBF plug to complete the installation. The TBF mates with 3106, 3107 and 3108 plugs.

Shell Size	K Max.	L Max.	M		T		V Max.	A Thread
			+ .031 (0.79) - .000 (0.00)	R ± .005 (0.13)	S ± .031 (0.79)	+ .010 (0.25) - .005 (0.13)		
8S	.125 (3.18)	1.482 (37.64)	.562 (14.27)	.594 (15.09)	.875 (22.22)	.120 (3.05)	.325 (8.26)	1/2-28UNEF-2A
10S	.125 (3.18)	1.482 (37.64)	.562 (14.27)	.179 (18.26)	1.000 (25.40)	.120 (3.05)	.325 (8.26)	5/8-24UNEF-2A
10SL	.125 (3.18)	1.482 (37.64)	.562 (14.27)	.179 (18.26)	1.000 (25.40)	.120 (3.05)	.325 (8.26)	5/8-24UNEF-2A
12S	.140 (3.56)	1.482 (37.64)	.562 (14.27)	.812 (20.62)	1.094 (27.79)	.120 (3.05)	.325 (8.26)	3/4-20UNEF-2A
14S	.140 (3.56)	1.482 (37.64)	.562 (14.27)	.906 (23.01)	1.188 (30.18)	.120 (3.05)	.325 (8.26)	7/8-20UNEF-2A
16S	.140 (3.56)	1.482 (37.64)	.562 (14.27)	.968 (24.59)	1.281 (32.54)	.120 (3.05)	.325 (8.26)	1-20UNEF-2A
12	.146 (3.71)	2.030 (51.56)	.750 (19.05)	.812 (20.62)	1.094 (27.79)	.120 (3.05)	.445 (11.30)	3/4-20UNEF-2A
14	.146 (3.71)	2.030 (51.56)	.750 (19.05)	.906 (23.01)	1.188 (30.18)	.120 (3.05)	.445 (11.30)	7/8-20UNEF-2A
16	.146 (3.71)	2.030 (51.56)	.750 (19.05)	.968 (24.59)	1.281 (32.54)	.120 (3.05)	.445 (11.30)	1-20UNEF-2A
18	.180 (4.57)	2.030 (51.56)	.750 (19.05)	1.062 (26.97)	1.375 (34.92)	.120 (3.05)	.445 (11.30)	1-1/8-18UNEF-2A
20	.180 (4.57)	2.030 (51.56)	.750 (19.05)	1.156 (29.36)	1.500 (38.10)	.120 (3.05)	.445 (11.30)	1-1/4-18UNEF-2A
22	.180 (4.57)	2.030 (51.56)	.750 (19.05)	1.250 (31.75)	1.625 (34.28)	.120 (3.05)	.445 (11.30)	1-3/8-18UNEF-2A
24	.203 (5.16)	2.030 (51.56)	.812 (20.62)	1.375 (34.92)	1.750 (44.45)	.147 (3.73)	.383 (9.73)	1-1/2-18UNEF-2A
28	.203 (5.16)	2.030 (51.56)	.812 (20.62)	1.562 (39.67)	2.000 (50.80)	.147 (3.73)	.383 (9.73)	1-3/4-18UNS-2A
32	.203 (5.16)	2.030 (51.56)	.875 (22.22)	1.750 (44.45)	2.250 (57.15)	.173 (4.39)	.320 (8.13)	2-18UNS-2A
36	.203 (5.16)	2.030 (51.56)	.812 (20.62)	1.938 (49.23)	2.500 (63.50)	.173 (4.39)	.383 (9.73)	2-1/4-16UN-2A
40	.203 (5.16)	2.030 (51.56)	.875 (22.22)	2.188 (55.58)	2.750 (69.85)	.173 (4.39)	.383 (9.73)	

Performance Specifications - Page A-84

Contacts, Sealing Plugs, Assembly Tools - Page A-105

Contact Arrangements - Page A-85 – A-89

Dimensions shown in inches (mm)
Specifications and dimensions subject to change

www.ittcannon.com



MIL-DTL-5015 Bulkhead Receptacles BFR/TBF



BFR

A

Circular



Pressurized Bulkhead Receptacle

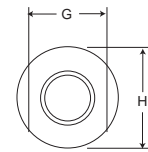
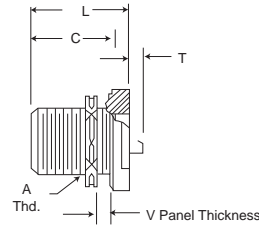
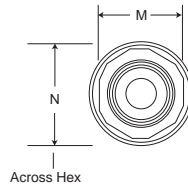

TYPE 1

BFR pressurized bulkhead receptacles withstand the air leakage requirements of MIL-C-5015 not to exceed 1 cu. in. of air per hour when subjected to a pressure differential of 30 psi at -55°C. Insulators are resilient material bonded to aluminum shell. Both pin and socket assemblies are available. The BFR will mate with standard MS type 3106 and 3108 plugs.

- Shell Standard
- Insulator Polychloroprene
- Lock Nut Hex with 6 wire holes
- O Ring Neoprene
- Position Pin Standard
- Mounting Figure 1 or 2
- Part No. Example BFR-14S-SP-1

Shell Size	C Max.	G Max.	H Max.	L Max.	M Max.	N Max.	#16	T Max. Solder Pot Ext.				V Max.
								#12	#8	#4	#0	
8S	.853 (21.67)	.895 (22.73)	1.077 (27.36)	1.087 (27.61)	.702 (17.83)	.820 (20.83)	.140 (3.56)	-	-	-	-	.250 (6.35)
10S	.853 (21.67)	1.015 (25.78)	1.203 (30.56)	1.087 (27.61)	.822 (20.88)	.960 (24.38)	.140 (3.56)	-	-	-	-	.250 (6.35)
10SL	.853 (21.67)	1.015 (25.78)	1.203 (30.56)	1.087 (27.61)	.822 (20.88)	.960 (24.38)	.140 (3.56)	-	-	-	-	.250 (6.35)
12S	.853 (21.67)	1.077 (27.36)	1.327 (33.71)	1.087 (27.61)	.955 (24.26)	1.110 (28.19)	.140 (3.56)	-	-	-	-	.250 (6.35)
14S	.853 (21.67)	1.203 (30.56)	1.453 (36.91)	1.087 (27.61)	1.072 (27.23)	1.250 (31.75)	.140 (3.56)	-	-	-	-	.375 (9.52)
16S	.853 (21.67)	1.327 (33.71)	1.577 (40.06)	1.087 (27.61)	1.265 (32.13)	1.460 (37.08)	.140 (3.56)	-	-	-	-	.375 (9.52)
12	1.244 (31.60)	1.077 (27.36)	1.327 (33.71)	1.525 (38.74)	.955 (24.26)	1.110 (28.19)	.062 (1.57)	.062 (1.57)	-	-	-	.375 (9.52)
14	1.244 (31.60)	1.203 (30.56)	1.453 (36.91)	1.525 (38.74)	1.072 (27.23)	1.250 (31.75)	.062 (1.57)	.062 (1.57)	.125 (3.18)	-	-	.375 (9.52)
16	1.244 (31.60)	1.327 (33.71)	1.577 (40.06)	1.525 (38.74)	1.265 (32.13)	1.460 (37.08)	.062 (1.57)	.062 (1.57)	.125 (3.18)	.125 (3.18)	-	.375 (9.52)
18	1.244 (31.60)	1.453 (36.91)	1.703 (43.26)	1.525 (38.74)	1.395 (35.43)	1.610 (40.89)	.062 (1.57)	.062 (1.57)	.125 (3.18)	.125 (3.18)	-	.375 (9.52)
20	1.244 (31.60)	1.577 (40.06)	1.827 (46.41)	1.525 (38.74)	1.515 (38.48)	1.750 (44.45)	.062 (1.57)	.062 (1.57)	.125 (3.18)	.125 (3.18)	.359 (9.12)	.375 (9.52)
22	1.244 (31.60)	1.577 (40.06)	1.953 (49.61)	1.525 (38.74)	1.635 (41.53)	1.900 (48.26)	.062 (1.57)	.062 (1.57)	.125 (3.18)	.125 (3.18)	.359 (9.12)	.375 (9.52)
24	1.244 (31.60)	1.827 (46.41)	2.077 (52.76)	1.525 (38.74)	1.765 (44.83)	2.030 (51.56)	.062 (1.57)	.062 (1.57)	.125 (3.18)	.125 (3.18)	.359 (9.12)	.375 (9.52)
28	1.244 (31.60)	1.953 (49.61)	2.327 (59.11)	1.525 (38.74)	2.015 (51.18)	2.330 (59.18)	.062 (1.57)	.062 (1.57)	.125 (3.18)	.125 (3.18)	.359 (9.12)	.375 (9.52)
32	1.244 (31.60)	2.203 (55.96)	2.577 (65.45)	1.525 (38.74)	2.205 (56.01)	2.550 (64.77)	.062 (1.57)	.062 (1.57)	.125 (3.18)	.125 (3.18)	.359 (9.12)	.375 (9.52)
36	1.244 (31.60)	2.577 (65.46)	2.827 (71.81)	1.525 (38.74)	2.455 (62.36)	2.840 (72.14)	.062 (1.57)	.062 (1.57)	.125 (3.18)	.125 (3.18)	.359 (9.12)	.312 (7.92)

Performance Specifications - Page A-84

Contact, Ceiling Plugs, Assembly Tools - Page A-105

Contact Arrangements - Page A-85 - A-89

Shell Size	A Thread	Shell Size	A Thread
8S	1/2-28UNEF-2A	16	1-20UNEF-2A
10S	5/8-24UNEF-2A	18	1-1/8-18UNEF-2A
10SL	5/8-24UNEF-2A	20	1-1/4-18UNEF-2A
12S	3/4-20UNEF-2A	22	1-3/8-18UNEF-2A
14S	7/8-20UNEF-2A	24	1-1/2-18UNEF-2A
16S	1-20UNEF-2A	28	1-3/4-18UNS-2A
12	3/4-20UNEF-2A	32	2-18UNS-2A
14	7/8-20UNEF-2A	36	2-1/4-16UN-2A

Mounting Dimensions

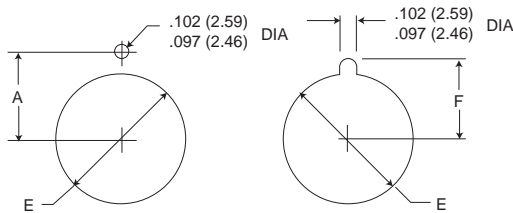

Fig. 1

Fig. 2

Shell Size	A			E			F		
	±.005 (0.13)	+0.015 (0.38)	-0.000 (0.00)	±.005 (0.13)	+0.015 (0.38)	-0.000 (0.00)	±.005 (0.13)	+0.015 (0.38)	-0.000 (0.00)
8S	.323 (8.20)	.500 (12.70)	.373 (9.47)	.698 (17.73)	1.250 (31.75)	.748 (19.00)			
10S, 10SL	.385 (9.78)	.625 (15.88)	.435 (11.05)	.760 (19.30)	1.375 (34.92)	.810 (20.57)			
12S, 12	.448 (11.38)	.750 (19.05)	.498 (12.65)	.823 (20.90)	1.500 (38.10)	.873 (22.17)			
14S, 14	.510 (12.95)	.875 (22.22)	.560 (14.22)	.948 (24.08)	1.750 (44.45)	.998 (25.35)			
16S, 16	.573 (14.55)	1.000 (25.40)	.623 (15.82)	1.073 (27.25)	2.000 (50.80)	1.123 (28.52)			
18	.635 (16.13)	1.125 (28.58)	.685 (17.40)	1.198 (30.43)	2.250 (57.15)	1.248 (31.70)			



Dimensions shown in inches (mm)
Specifications and dimensions subject to change

www.ittcannon.com

MIL-DTL-5015 Connectors

Panel Cutouts

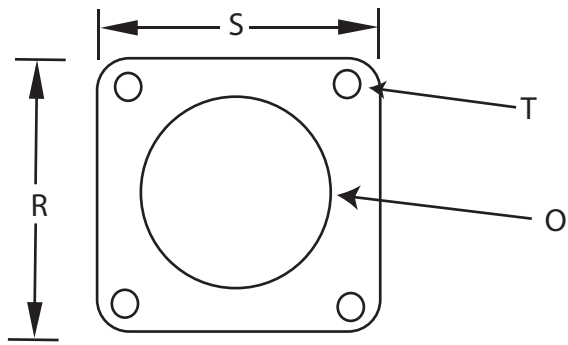

Flange dimensions and mounting holes for 5015 type MS receptacles. Mounting hole diameters do not apply to MS5015 class KT & KS connectors.

DIM TOL	±.005	±.031		±.005
Shell Size	R	S	O	T
8S	.594	.875	.562	.120
10S & 10SL	.719	1.000	.688	.120
12 & 12S	.812	1.094	.812	.120
14 & 14S	.906	1.188	.938	.120
16 & 16S	.969	1.281	1.062	.120
18	1.062	1.375	1.188	.120
20	1.156	1.500	1.312	.120
22	1.250	1.625	1.438	.120
24	1.375	1.750	1.562	.147
28	1.562	2.000	1.812	.147
32	1.750	2.250	2.062	.173
36	1.938	2.500	2.312	.173
40	2.188	2.750	2.562	.173



A

Circular

Dimensions shown in inches (mm)
 Specifications and dimensions subject to change

www.ittcannon.com



MIL-DTL-5015 Connectors Accessories



A

Circular

Plug Metal Protective Caps

MS25042



CA17530
CA19741

For 06 and 08 Style Plugs

These externally threaded metal dust caps are used to protect the MS3106 and MS3108 plugs. Material is aluminum alloy. They are furnished with sash chain or less sash chain.

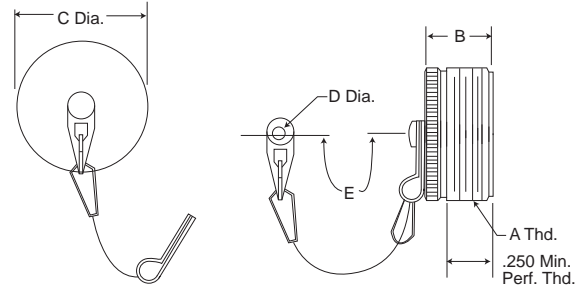

Black Anodized Finish With Sash Chain		Part Number		Olive Drab Chromate Over Cadmium Finish with Sash Chain		Olive Drab Chromate Over Cadmium Finish Without Sash Chain		Fits	B	C	E	D	A
MS	ITT Cannon	MS Number (Ref)	ITT Part Number	MS Number (Ref)	ITT Part Number	MS Number (Ref)	ITT Part Number	Shell Size	Max.	Dia. Max.	Max.	Dia. Max.	Thread
MS25042-8DA	CA17530-8000	MS25042-8D	CA17530-5100	MS25042-8D	CA17530-5100	MS25042-8D	CA19741-8	8S	.656 (16.66)	.562 (14.27)	4.500 (114.30)	.166 (4.22)	1/2-28UNEF-2A
MS25042-10DA	CA17530-8001	MS25042-10D	CA17530-5101	MS25042-10D	CA17530-5101	MS25042-10D	CA19741-10	10S, 10SL	.656 (16.66)	.687 (17.45)	4.500 (114.30)	.166 (4.22)	5/8-24UNEF-2A
MS25042-12DA	CA17530-8002	MS25042-12D	CA17530-5102	MS25042-12D	CA17530-5102	MS25042-12D	CA19741-12	12, 12S	.844 (21.44)	.812 (20.62)	5.500 (139.70)	.166 (4.22)	3/4-20UNEF-2A
MS25042-14DA	CA17530-8003	MS25042-14D	CA17530-5103	MS25042-14D	CA17530-5103	MS25042-14D	CA19741-14	14, 14S	.844 (21.44)	.937 (23.80)	5.500 (139.70)	.166 (4.22)	7/8-20UNEF-2A
MS25042-16DA	CA17530-8004	MS25042-16D	CA17530-5104	MS25042-16D	CA17530-5104	MS25042-16D	CA19741-16	16, 16S	.844 (21.44)	1.062 (26.97)	5.500 (139.70)	.166 (4.22)	1-20UNEF-2A
MS25042-18DA	CA17530-8005	MS25042-18D	CA17530-5105	MS25042-18D	CA17530-5105	MS25042-18D	CA19741-18	18	.844 (21.44)	1.187 (30.15)	5.500 (139.70)	.166 (4.22)	1-1/8-18UNEF-2A
MS25042-20DA	CA17530-8006	MS25042-20D	CA17530-5106	MS25042-20D	CA17530-5106	MS25042-20D	CA19741-20	20	.844 (21.44)	1.312 (33.32)	5.500 (139.70)	.197 (5.00)	1-1/4-18UNEF-2A
MS25042-22DA	CA17530-8007	MS25042-22D	CA17530-5107	MS25042-22D	CA17530-5107	MS25042-22D	CA19741-22	22	.844 (21.44)	1.437 (36.50)	5.500 (139.70)	.197 (5.00)	1-3/8-18UNEF-2A
MS25042-24DA	CA17530-8008	MS25042-24D	CA17530-5108	MS25042-24D	CA17530-5108	MS25042-24D	CA19741-24	24	.844 (21.44)	1.562 (39.67)	6.000 (152.40)	.197 (5.00)	1-1/2-18UNEF-2A
MS25042-28DA	CA17530-8009	MS25042-28D	CA17530-5109	MS25042-28D	CA17530-5109	MS25042-28D	CA19741-28	28	.844 (21.44)	1.812 (46.02)	8.250 (209.55)	.197 (5.00)	1-3/4-18UNEF-2A
MS25042-32DA	CA17530-8010	MS25042-32D	CA17530-5110	MS25042-32D	CA17530-5110	MS25042-32D	CA19741-32	32	.844 (21.44)	2.062 (52.37)	8.250 (209.55)	.228 (5.79)	2-18UNEF-2A
MS25042-36DA	CA17530-8011	MS25042-36D	CA17530-5111	MS25042-36D	CA17530-5111	MS25042-36D	CA19741-36	36	.844 (21.44)	2.312 (58.72)	8.250 (209.55)	.228 (5.79)	2-1/4-16UN-2A
MS25042-40DA	CA17530-8012	MS25042-40D	CA17530-5112	MS25042-40D	CA17530-5112	MS25042-40D	CA19741-40	40	.844 (21.44)	2.562 (65.07)	8.250 (209.55)	.228 (5.79)	2-1/2-16UN-2A
MS25042-44DA	CA17530-8013	MS25042-44D	CA17530-5113	MS25042-44D	CA17530-5113	MS25042-44D	CA19741-44	44	.844 (21.44)	2.812 (71.42)	8.250 (209.55)	.228 (5.79)	2-3/4-16UN-2A
MS25042-48DA	CA17530-8014	MS25042-48D	CA17530-5114	MS25042-48D	CA17530-5114	MS25042-48D	CA19741-48	48	.844 (21.44)	3.062 (77.77)	8.250 (209.55)	.228 (5.79)	3-16UN-2A

Plug Metal Protective Caps

MS25043



CA2209
CA2322

For 00, 01 and 02 Style Receptacles

These internally threaded metal dust caps are used to protect the MS3100, MS3101 and MS3102 receptacles. Material is aluminum alloy. They are furnished with sash chain or less sash chain.

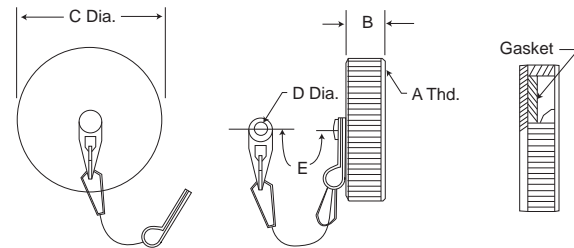

Black Anodized Finish With Sash Chain		Part Number		Olive Drab Chromate Over Cadmium Finish with Sash Chain		Olive Drab Chromate Over Cadmium Finish Without Sash Chain		Fits	B	C	E	D	A
MS	ITT Cannon	MS Number (Ref)	ITT Part Number	MS Number (Ref)	ITT Part Number	MS Number (Ref)	ITT Part Number	Shell Size	Max.	Dia. Max.	Max.	Dia. Max.	Thread
MS25043-8DA	CA2209-8000	MS25043-8D	CA2209-5100	MS25043-8D	CA2209-5100	MS25043-8D	CA2322-1	8S	.469 (11.91)	.688 (17.48)	4.500 (114.30)	.150 (3.81)	1/2-28UNEF-2B
MS25043-10DA	CA2209-8001	MS25043-10D	CA2209-5101	MS25043-10D	CA2209-5101	MS25043-10D	CA2322-2	10S, 10SL	.469 (11.91)	.815 (20.70)	4.500 (114.30)	.150 (3.81)	5/8-24UNEF-2B
MS25043-12DA	CA2209-8002	MS25043-12D	CA2209-5102	MS25043-12D	CA2209-5102	MS25043-12D	CA2322-3	12, 12S	.469 (11.91)	1.000 (25.40)	5.500 (139.70)	.150 (3.81)	3/4-20UNEF-2B
MS25043-14DA	CA2209-8003	MS25043-14D	CA2209-5103	MS25043-14D	CA2209-5103	MS25043-14D	CA2322-4	14, 14S	.469 (11.91)	1.125 (28.58)	5.500 (139.70)	.150 (3.81)	7/8-20UNEF-2B
MS25043-16DA	CA2209-8004	MS25043-16D	CA2209-5104	MS25043-16D	CA2209-5104	MS25043-16D	CA2322-5	16, 16S	.469 (11.91)	1.188 (30.18)	5.500 (139.70)	.150 (3.81)	1-20UNEF-2B
MS25043-18DA	CA2209-8005	MS25043-18D	CA2209-5105	MS25043-18D	CA2209-5105	MS25043-18D	CA2322-6	18	.469 (11.91)	1.344 (34.14)	5.500 (139.70)	.150 (3.81)	1-1/8-18UNEF-2B
MS25043-20DA	CA2209-8006	MS25043-20D	CA2209-5106	MS25043-20D	CA2209-5106	MS25043-20D	CA2322-7	20	.469 (11.91)	1.469 (37.31)	5.500 (139.70)	.150 (3.81)	1-1/4-18UNEF-2B
MS25043-22DA	CA2209-8007	MS25043-22D	CA2209-5107	MS25043-22D	CA2209-5107	MS25043-22D	CA2322-8	22	.469 (11.91)	1.594 (40.49)	5.500 (139.70)	.150 (3.81)	1-3/8-18UNEF-2B
MS25043-24DA	CA2209-8008	MS25043-24D	CA2209-5108	MS25043-24D	CA2209-5108	MS25043-24D	CA2322-9	24	.469 (11.91)	1.719 (43.66)	6.000 (152.40)	.181 (4.60)	1-1/2-18UNEF-2B
MS25043-28DA	CA2209-8009	MS25043-28D	CA2209-5109	MS25043-28D	CA2209-5109	MS25043-28D	CA2322-10	28	.531 (13.49)	1.969 (50.01)	8.250 (209.55)	.181 (4.60)	1-3/4-18UNS-2B
MS25043-32DA	CA2209-8010	MS25043-32D	CA2209-5110	MS25043-32D	CA2209-5110	MS25043-32D	CA2322-11	32	.531 (13.49)	2.219 (56.36)	8.250 (209.55)	.197 (5.00)	2-18UNS-2B
MS25043-36DA	CA2209-8011	MS25043-36D	CA2209-5111	MS25043-36D	CA2209-5111	MS25043-36D	CA2322-12	36	.531 (13.49)	2.469 (62.71)	8.250 (209.55)	.197 (5.00)	2-1/4-16UN-2B
MS25043-40DA	CA2209-8012	MS25043-40D	CA2209-5112	MS25043-40D	CA2209-5112	MS25043-40D	CA2322-13	40	.531 (13.49)	2.719 (69.06)	8.250 (209.55)	.197 (5.00)	2-1/2-16UN-2B
MS25043-44DA	CA2209-8013	MS25043-44D	CA2209-5113	MS25043-44D	CA2209-5113	MS25043-44D	CA2322-14	44	.531 (13.49)	2.969 (75.41)	8.250 (209.55)	.197 (5.00)	2-3/4-16UN-2B
MS25043-48DA	CA2209-8014	MS25043-48D	CA2209-5114	MS25043-48D	CA2209-5114	MS25043-48D	CA2322-15	48	.531 (13.49)	3.188 (80.98)	8.250 (209.55)	.197 (5.00)	3-16UN-2B



Dimensions shown in inches (mm)
Specifications and dimensions subject to change

www.ittcannon.com

MIL-DTL-5015 Connectors Accessories

Cable Clamp

M85049-41
With or without bushing

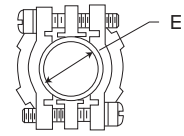
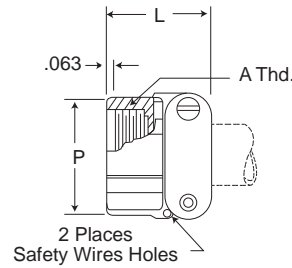
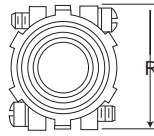

A

Circular

M85049-41 cable clamp is made for plugs and receptacles that have an endbell with external conduit threads. The double clamping action provides a balanced, positive hold on the wires and greatly reduces moisture transmission. Provision is made for safety wiring. This clamp is supplied without bushing; to order bushing, add "with bushing" after part number.

Part Number*	Superseded Part Number	Fits Shell Size	Accommodates MS Bushings	E Min.	E Max.	L ±.031 (0.79)	P ±0.31 (0.79)	R ±0.31 (0.79)	A Thread
M85049/41-3A	MS3057-3A	8S-10S	MS3420-3	.102 (2.59)	.250 (6.35)	.812 (20.62)	.688 (17.48)	.812 (20.62)	1/2-28UNEF-2B
M85049/41-4A	MS3057-4A	10SL, 12S, 12	MS3420-4	.140 (3.56)	.312 (7.92)	.812 (20.62)	.812 (20.62)	.875 (22.22)	5/8-24UNEF-2B
M85049/41-6A	MS3057-6A	14S, 14	MS3420-6	.195 (4.95)	.438 (11.13)	.875 (22.22)	.969 (24.61)	1.062 (26.97)	3/4-20UNEF-2B
M85049/41-8A	MS3057-8A	16S, 16	MS3420-8	.255 (6.48)	.562 (14.27)	.938 (23.83)	1.094 (27.79)	1.156 (29.36)	7/8-20UNEF-2B
M85049/41-10A	MS3057-10A	18	MS3420-10	.285 (7.24)	.625 (15.88)	.938 (23.83)	1.188 (30.18)	1.250 (31.75)	1-20UNEF-2B
M85049/41-12A	MS3057-12A	20, 22	MS3420-12	.350 (8.89)	.750 (19.05)	.938 (23.83)	1.375 (34.92)	1.496 (37.31)	1-3/16-18UNEF-2B
M85049/41-16A	MS3057-16A	24, 28	MS3420-16,12	.468 (11.89)	.938 (23.83)	1.031 (26.19)	1.656 (42.06)	1.688 (42.88)	1-7/16-18UNEF-2B
M85049/41-20A	MS3057-20A	32	MS3420-20,16	.664 (16.87)	1.250 (31.75)	1.094 (27.79)	2.031 (51.59)	2.031 (51.59)	1-3/4-18UNS-2B
M85049/41-24A	MS3057-24A	36	MS3420-24,20	.694 (17.63)	1.375 (34.92)	1.156 (29.36)	2.219 (56.36)	2.281 (57.94)	2-18UNS-2B
M85049/41-28A	MS3057-28A	40	MS3420-24,20	.911 (23.14)	1.625 (41.28)	1.688 (42.88)	2.500 (63.50)	2.688 (68.28)	2-1/4-16UN-2B
M85049/41-32A	MS3057-32A	44	MS3420-32,28,24	-	1.875 (47.62)	1.750 (44.45)	2.781 (70.64)	2.938 (74.63)	2-1/2-16UN-2B
M85049/41-40A	MS3057-40A	48	MS3420-40,32,28	-	2.375 (60.32)	1.750 (44.45)	3.281 (83.34)	3.500 (88.90)	3-16UN-2B

*To order cable clamp with bushing, add "with bushing" after part number.

Telescoping Bushing

MS3420/
MS39056(REF)

CA18220

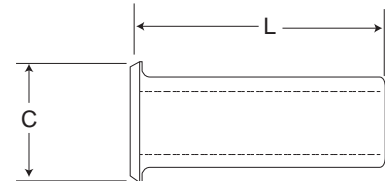
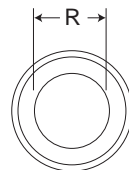
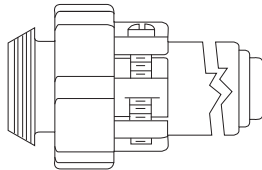

Telescoping bushing with
M85049/41 cable clamp

Telescoping gland bushing (used with M85049/41 cable clamp) keep dirt, oil and moisture out of endbell. Taping or wrapping wires is eliminated since bushing protects wires going through clamp. Combinations of bushings may be used to decrease cable entry diameter to improve sealing.

MS Part Number	Superseded MS Part Number	ITT Cannon Part Number	Fits Shell Size	C ±0.16 (0.41)	L ±0.31 (0.79)	R ±0.16 (0.41)
MS3420-3	MS39056-1	CA18220-3	8S-10S	.379 (9.63)	2.875 (73.02)	.130 (3.30)
MS3420-4	MS39056-2	CA18220-4	10SL, 12S, 12	.505 (12.83)	2.750 (69.85)	.200 (5.59)
MS3420-6	MS39056-3	CA18220-6	14S, 14	.619 (15.72)	2.625 (66.68)	.312 (7.92)
MS3420-8	MS39056-4	CA18220-8	16S, 16	.744 (18.90)	2.500 (63.50)	.437 (11.10)
MS3420-10	MS39056-5	CA18220-10	18	.869 (22.07)	2.375 (60.32)	.562 (14.27)
MS3420-12	MS39056-6	CA18220-12	20, 22	1.064 (27.03)	2.250 (57.15)	.625 (15.88)
MS3420-16	MS39056-7	CA18220-16	24, 28	1.314 (33.38)	2.125 (53.98)	.750 (19.05)
MS3420-20	MS39056-8	CA18220-20	32	1.596 (40.54)	2.000 (50.80)	.937 (23.80)
MS3420-24	MS39056-9	CA18220-24	36	1.847 (46.91)	1.875 (47.62)	1.250 (31.75)
MS3420-28	MS39056-10	CA18220-28	40	2.085 (52.96)	1.750 (44.45)	1.375 (34.92)
MS3420-32	MS39056-11	CA18220-32	44	2.335 (59.31)	1.625 (41.28)	1.624 (41.25)
MS3420-40	MS39056-12	CA18220-40	48	2.835 (72.01)	1.500 (38.10)	1.874 (47.60)

Dimensions shown in inches (mm)
Specifications and dimensions subject to change

www.ittcannon.com



MIL-DTL-5015 Connectors Accessories

Plastic Protective Caps



Circular
A

025-XXXX-000

Protective dust caps are designed to cover the coupling and conduit ends of MS connectors where there is a possibility of foreign matter accumulating on the interior of the connector or of damage to the threaded parts. Material is red polyethylene. Plastic dust caps can be reused, but are not intended to replace the standard aluminum dust caps shown in preceding pages.

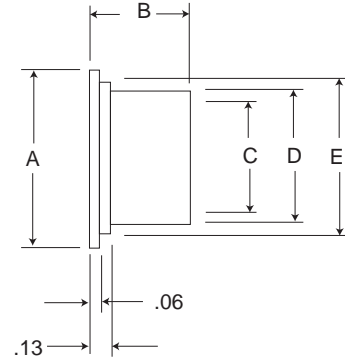

Part Number	MS3100FR		MS3102FR		MS-F (only) Solder Pot End	MS3106/MS3108 FR		Dimensions					
	Coupling End	Solder Pot End	Coupling End	Solder Pot End		Coupling End	Solder Pot End	A Max.	B Max.	C Max.	D Max.	E Max.	Wt. Lb.
025-0458-000				85	85	.469 (11.91)		.673	.440	.430	.486	.583	.0012
025-0459-000	8S	8S, 10S	8S	8S, 10S				.734	.440	.490	.546	.644	.0014
025-0460-000	10S, 10SL	10SL, 12S, 12	10S, 10SL	10SL, 12S, 12				.848	.700	.600	.656	.758	.0022
025-0462-000	12S, 12	14S, 14	12S, 12	14S, 14				.973	.700	.730	.786	.883	.0028
025-0463-000	14S, 14	16S, 16	14S, 14	16S, 16				1.098	.700	.850	.908	1.008	.0033
025-0466-000				18				1.209	.700	.950	1.016	1.119	.0042
025-0467-000				20				1.396	.700	1.150	1.216	1.308	.0054
025-0468-000	20		20	22				1.500	.700	1.240	1.306	1.405	.0060
025-0469-000	22		22	24				1.625	.700	1.360	1.426	1.530	.0067
025-0470-000				28				1.870	.700	1.610	1.676	1.775	.0087
025-0471-000				32				2.120	.700	1.860	1.926	2.025	.0103
025-0472-000				36				2.370	.700	2.110	2.176	2.275	.0141
025-0473-000				40				2.501	.700	2.310	2.380	2.491	.0164
025-0474-000				44				2.872	.700	2.590	2.660	2.772	.0186
025-0475-000				48				3.122	.700	2.840	2.910	30.22	.0222
025-0477-000						10S, 10SL		.802	.491	.550	.616	.712	.0017
025-0478-000						12S, 12		.911	.571	.669	.725	.821	.0022
025-0479-000						14S, 14		1.036	.571	.794	.850	.946	.0027
025-0480-000						16S, 16		1.161	.571	.919	.975	1.071	.0033
025-0484-000						18		1.290	.576	1.028	1.094	1.195	.0044
025-0486-000						22		1.540	.576	1.278	1.344	1.445	.0058
025-0487-000						24		1.665	.576	1.403	1.469	1.570	.0066
025-0488-000						28		1.907	.576	1.645	1.711	1.812	.0084
025-0489-000						32		2.157	.576	1.895	1.961	2.062	.0102
025-0490-000						36		2.412	.576	2.140	2.216	2.317	.0132
025-0491-000						40		2.672	.576	2.390	2.466	2.572	.0163
025-0492-000						44		2.922	.576	2.640	2.716	2.822	.0186
025-0493-000						48		3.172	.576	2.890	2.966	3.072	.0213
025-0498-000	16S, 16	18	16S, 16	48		18		1.240	.700	.990	1.056	1.150	.0044
025-0499-000		20, 22		36		22	20, 22	1.427	.700	1.117	1.183	1.337	.0055
025-0500-000		24, 24		40			24, 28	1.677	.700	1.420	1.486	1.587	.0072
025-0501-000	28	32	28	44			32	1.985	.700	1.730	1.796	1.895	.0095
025-0502-000	32	36	32	32			36	2.245	.700	1.980	2.046	2.155	.0114
025-0503-000	36	40	36	24, 28			40	2.495	.700	2.230	2.296	2.400	.0134
025-0504-000	40	44	40	20, 22			44	2.742	.700	2.480	2.546	2.652	.0186
025-0505-000	48		48	18			48	3.257	.700	2.980	3.046	3.157	.0233
025-0507-000	18		18		20			1.365	.700	1.110	1.176	1.275	.0050
025-0510-000	24		24					1.740	.700	1.490	1.556	1.650	.0077
025-0511-000	44	48	44					3.007	.700	2.730	2.796	2.907	.0220
025-0608-000					8S			.643	.440	.400	.456	.553	.0011
025-0609-000					10SL, 12S, 12			.829	.700	.580	.636	.739	.0021
025-0610-000					14S, 14			.954	.700	.710	.766	.864	.0028
025-0611-000					16S, 16			1.079	.700	.830	.886	.989	.0032
025-0612-000					28			1.839	.700	1.570	1.626	1.744	.0088
025-0613-000					32			2.089	.700	1.820	1.876	1.994	.0100
025-0614-000					36			2.376	.700	2.010	2.066	2.231	.0132



Dimensions shown in inches (mm)
Specifications and dimensions subject to change

www.ittcannon.com

F80 Assembly Instructions



A

Circular

ITT Cannon provides a complete line of crimp insertion and extraction tooling to be used with CA-F80 contacts as follows.

Contact Size	Hand Crimp Tool*	Locator	Power Crimp Tool*	Crimp Head	Locator	Gauge
16	M-2252/1-01	TH-70-1	CBT-530			
12	M-2252/1-01	TP567	CBT-600/600B	CCH-12-7	CCHP-12-2	-
8	-	-	CBT-600/600B	CCH-8-1	CCHP-8-1	CCH-8-1
4	-	-	CBT-600/600B	CCH-4-1	CCHP-4-1	CCH-4-1
0	-	-	CBT-600B	CCH-0-1	CCHP-0-9	CCH-0

*The M-2252/1-01 is the MIL standard crimp tool for #12 thru #20 contacts and when used with crimp #12, 16 and 20 contacts for the CA-F80.

**The CBT-600 is recommended for crimping of #4 thru #12 contacts. The CBT-600B for #0 thru #8. The appropriate locators and crimp heads are available as shown above.



CBT-600



CBT-520/530

Crimp Tool



Crimping Contacts

1. Check the crimp tool to be sure that the proper crimp head locator is used.
2. Cycle to tool to be sure the indentors are open.
3. Place the contact, mating end first, into the tool.
4. Insert the stripped wire into the hollow end of the contact. Be sure the wire is inserted as far as it will go.
5. Close the tool completely to crimp. Unless the tool is closed completely, the tool will not release the contact.
6. Remove the crimped contact from the tool. Check the inspection hole to verify that the wire is fully inserted.

Insertion/Extraction Tools



Insertion and extraction tools used for these connectors are available for contact sizes 16 thru 0 as shown.

Contact Size	Insertion Tools	Extraction Tools	Handle Color
16	CIT-16 (038895-0000)	CET-16-4 (038888-0004)	Blue
12	CIT-12 (038896-0000)	CET-12-2 (038890-0002)	Yellow
8	CIT-8	CET-8	Red
4	CIT-4	CET-4	Blue
0	CIT-0	CET-0	Yellow

Insertion of Contacts

1. Before inserting the contacts, remove the endbell, grommets, and ferrule from the receptacle. Remove the endbell, grommet, ferrule, and coupling nut from the plug. Slide the hardware over the wire bundle in the proper order for reassembly after all the contacts are inserted.
2. To assist insertion of contacts, lubricate insert cavities with isopropyl alcohol. Alcohol will evaporate and will not leave a conductive film. Caution: Never use any lubricant other than isopropyl alcohol. Hold the plug or receptacle body firmly and insert the wired contacts as far as possible by hand. Starting at one side of the insulator, work progressively from contact to contact across the layout. When inserting socket contacts, be sure to provide fixture space below the front face to permit length of guide pins for #16 and #12 contacts to clear insulator face.
3. Place the correct insertion tool on the contact so that the wire runs along the groove in the tool. (Tool tip will butt against the shoulder.)
4. Beginning with a cavity on the outer edge of the plug, apply a slow, even pressure perpendicular to the insulator face until the contact snaps into position. If contacts are not inserted all the way prior to removing insertion tool, do not try to reinsert the insertion tool. Instead, using the extraction tool, push the contact back to the position it was in when the insertion tool was originally placed over the contact for push-in; otherwise the inside of contact cavity may be damaged by reinserting the insertion tool.
5. Inspect the front end of the insulator to assure that the contacts are inserted to the proper depth.

Completion

After all the cavities have been filled, slide the hardware back into position on the barrel. Tighten the endbell until the ferrule and endbell are flush. Compression of the grommet in this manner results in maximum sealing characteristics of the plug.

Extraction of Contacts

1. Select the appropriate tool. (Tool tips are reversible for either pin or socket.) Place the extraction tool over the pin or into the socket.
2. Apply a slow, even pressure to push the contact out of the rear of the insulator.

Recommended Wire Stripping

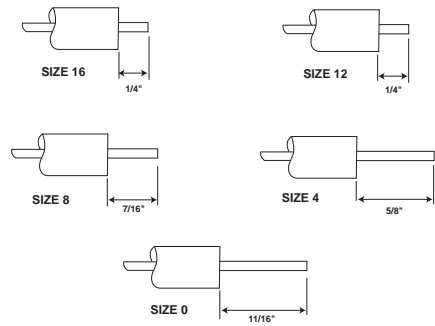

Contacts

Contact Size	Contact Part Numbers	
	Pin	Socket
16S	330-0345-016	031-0554-161
16	330-0351-016	031-0560-161
12	330-0351-012	031-0560-121
8	330-0351-008	031-0560-081
4	330-0351-004	031-0560-041
0	330-0351-000	031-0560-001

Guide Pins

Guide pins are used to assist insertion of socket contact Sizes #16 and #12. Larger sizes do not require guide pins.

Contact	Guide Pin
#16	226-1017-000
#12	226-1018-000

Wire Hole Fillers

Wire Size AWG	ITT Cannon Part Number	Color
20	225-1000-000	Red
16/16S	225-0017-000	Blue
12	225-0018-000	Yellow
8	225-0019-000	White
4	225-8502-000	Green
0	225-8503-000	Black

Dimensions shown in inches (mm)
Specifications and dimensions subject to change

www.ittcannon.com



X-ON Electronics

Largest Supplier of Electrical and Electronic Components

Click to view similar products for [Circular MIL Spec Connector](#) category:

Click to view products by [ITT](#) manufacturer:

Other Similar products are found below :

[89075GULPR](#) [0025-262-542](#) [0025-264-3014](#) [58-570121-04S](#) [0134-213-1208](#) [0134-213-2209](#) [0025-258-000](#) [60-042022-07P](#) [60-042022-19P](#)
[60-042022-23P](#) [60-042217-10P](#) [0114-201-1278](#) [012-0467-000](#) [602GB06EG24-61SN](#) [0134-201-1207](#) [0134-213-1006](#) [6104-207-2302](#) [6104-](#)
[208-1902](#) [61-168211-04P](#) [61-168617-10P](#) [6131-202-19149P](#) [6131-204-21149P](#) [6131-208-13149P](#) [6131-209-17149P](#) [6131-210-11149P](#) [6131-](#)
[211-19149P](#) [6131-216-19149P](#) [6131-259-21149P](#) [6131-259-23149P](#) [6131-265-17149P](#) [6131-265-19149P](#) [CS3100A18-1P-472](#) [CS3100A-36-](#)
[77P](#) [CS3101A-16-55P](#) [CS3102A-10SL-55P](#) [CS3102A-14S-58P](#) [CS3102A-32-17P](#) [CS3102A32-25S](#) [CS3102C18-4P-472](#)
[CS3106A10SL3S004](#) [CS3106A-18-73S](#) [CS3108A-14S-52S](#) [CS3108A-28-51S](#) [6162-233-1277](#) [6162-324-1231](#) [M243082296Z](#)
[M2884010AC1S1](#) [CT0-24-10SC](#) [CT0M20-7PCAU](#) [M28840/17AC1G3](#)