



ITT

**Interconnect Solutions
Cannon, VEAM, BIW**

Cannon Space Connectors



Engineered for life

Cannon, VEAM, BIW

A Historical Achievement of Technology Leadership

Defining and Championing Innovation

Showcasing a portfolio of creativity, ITT's "Engineered For Life" execution embraces products which have become ubiquitous in a broad collection of markets including: Military/Aerospace, Civil Aircraft, Industrial Instrumentation, Medical, Oil & Gas, Energy, Transportation, Telecom/Handset, Computer, Consumer, and Automotive.

ITT's rich interconnect history embraces contributions to both technological breakthroughs and social movements. With one of the industry's broadest product offerings, ITT's interconnect products have supported:

- Every Free World space mission, bringing the universe to our doorstep.
- Motion picture, radio, and television equipment, serving laughter and entertainment to millions.
- Commercial and military communications systems, linking the voices of the world.
- Computerized tools, reshaping the information highway.
- Aircraft, rapid transit, and automobiles, mobilizing our expanding society.
- Oil and natural gas production, powering the world's economies.

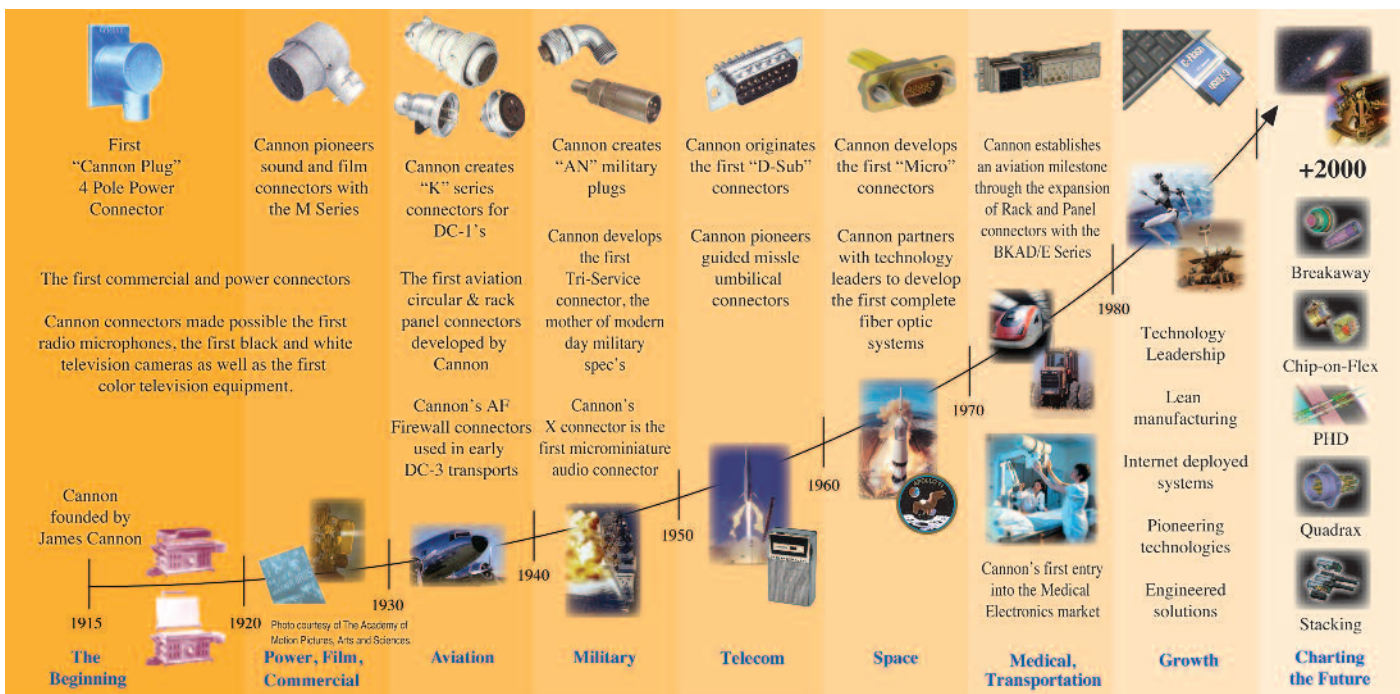

ITT Interconnect Solutions

ITT Interconnect Solutions is a division of the multi-national ITT Corporation, a \$11.6 billion dollar global enterprise representing the brands Cannon, VEAM, and BIW. Our connector portfolio remains the most extensive in the industry offering the most reliable and cost effective range of interconnect solutions. These innovations have enabled ITT to provide products and technologies to such markets as:

- Automotive
- Computer/Consumer
- Industrial/Instrumentation
- Military/Aerospace
- Oil Fields
- Telecom/Handset
- Transportation

When you specify a Cannon, VEAM or BIW connector, you can rely on a product designed, developed, and manufactured to the highest quality and reliability standards. This tradition of excellence is based on ITT's corporate culture of operating its businesses under the principles of Six Sigma. At ITT, Six Sigma is not just a quality philosophy but a complete corporate culture that drives the entire business. Our Value Based Management and Value Based Product Development systems are two cornerstones that allow for the development of both leadership and product engineering principles, ensuring the correct industry leading products are developed to the accepted market driven lead times. These principles have allowed ITT to become the market leader in all of our business portfolios.

Six Sigma Manufacturing

ITT operates manufacturing facilities in the United States, Germany, Italy, Mexico, China, Japan and the UK, all of which have particular product area strengths allowing ITT to offer a truly global footprint to our customers. Our facilities are world class and accommodate full vertical integration utilizing the latest manufacturing technologies including: automated and robotic machining centers, Super Market manufacturing cells, Kanban pull systems, and automated electrical, mechanical, and optical test and inspection equipment. The combination of our manufacturing strength and our advanced manufacturing facilities allows ITT to offer products at market driven

prices. Our capabilities, especially in robotics, computerized precision tooling, Kaizen Project Management, Six Sigma tools, and testing, give ITT the most optimized global manufacturing footprint in the interconnect industry.

The Custom Difference

As the industry leader in harsh environment interconnect applications, ITT's world class engineering teams will work directly with our customers to design and develop cost effective solutions for their applications. In many cases we may modify one of our standard designs to ensure a highly reliable solution where timing is critical. Yet, in those cases where a complete custom interconnect solution is required, ITT will work with our customer's Engineers to design an interconnect solution which will be cost effective yet highly reliable. As professional consultants, our Engineering teams will provide a thorough systems and mechanical analysis of any proposed solution. These analyses provide our customers with sophisticated electrical signal and mechanical characterizations to determine the best solution for their application.

RoHS Compliance Information

ITT has implemented a strict parts control plan for all ITT electronics plants worldwide that allows the Cannon, VEAM, and BIW connector product portfolios to meet the requirements of European Union Directive 2002/95/EC better known as the Reduction of Hazardous Substances initiative. As appropriate, specific Cannon, VEAM, and BIW products may be ordered with an R prefix number which insures our customers will receive RoHS compliant parts for their commercial electronics applications and equipment. Since most RoHS hazardous substances center around specific metal plating and lead solder coatings, ITT's products for RoHS compliance are available in the following plating finishes: electroless nickel, stainless steel, Anodize over aluminum and Gold plating. It should be noted that gold plating would be recommended as the replacement for tin-lead solder when ordering board mount connectors.



ITT Cannon Space Connectors

As a world leader in connector technology, ITT Interconnect Solutions occupies the enviable position as the primary supplier and innovator in mission critical space applications. Cannon's products have served on every free world space mission since the inception of space exploration, over 50 years ago. Reflecting this achievement, the United Space Alliance recognized ICS in 2007 with a certificate of appreciation for our efforts in supporting the shuttle and space station programs. Today, ITT ICS supports global space initiatives with one of the industry's broadest portfolios of high reliability, space grade products. Coupled with our extensive custom Engineering capability, Cannon provides unrivaled support and design expertise to the pioneering space community.



Connector Types

There are three major categories of High reliability connectors used in space flight application: D-Subminiature, Micro-miniature, and Circular, including Filters and Specials for all categories. The selection process depends on the type of application and size requirements; D-subminiature and Micro-D connectors are widely used on PCB and panel mount applications, as well as light duty cables. Circulars are typically used more for heavy duty cable and panel mount applications. Consequently, D-Sub type connectors typically favor Satellite applications whereas circular connectors favor launch and crew manned vehicles.



Photo courtesy of

Design and Materials

All space grade connector products meet the design and materials requirement of both NASA/GSFC and the European Space Agency. The key considerations for design conformance includes the adherence to Mil-Spec design standards that ensure the capability for interconnect. For D-Subminiature connectors, this standard is M24308, for Micro-D's it is M83513, and for Circular connectors it is M38999. NASA and ESA requirements deviate from these standards by recommending materials that ensure low levels of residual magnetism (or magnetic permeability) and materials outgassing. Many manufacturers of connectors use elastomers and plastics which contain compounds that may outgas over time. It is essential that these compounds be removed prior to final assembly and launch, usually by means of a bake-out process. It should be noted that ITT Cannon is one of the only space connector manufacturers that has developed specialized polymers that meet NASA and ESA outgassing requirements, even prior to bake out.

Quality Testing

NASA and ESA requirements specify that both screening and qualification testing be performed on all connectors used in space flight applications. NASA and ESA follow similar requirements as they jointly participate in programs that require intermateability and similar quality standards on mission critical applications. In some cases, qualification requirements may vary depending on the critical nature of the mission. Consequently, qualification may be periodic for a specific connector type or lot specific for a particular mission..

Introduction	4
• D Subminiature Connectors	
How to Order	5
Performance Specifications	6
Components Matrix	7
Standard, Combo Cable and PCB Connectors	8-19
High Density Connectors	20-28
Machined Aluminum Shell Versions	29-32
Standard Contacts	33-35
Assembly Instructions	36-37
High Power Contacts	38-39
NASA/GSFC Cross Reference	43-45
ESA/SCC Cross Reference	46-48
Panel Cutouts	49-50
Hardware Views	51-52
Contact Cavity Arrangments	53-55
PCB Hole Patterns	56-59
• Micro-D Connectors	
MDM Introduction	60-61
How to Order	62
Connectors	63-65
Mounting Hardware	65-67
MDM-PCB Introduction and How to Order	68
Connectors	69-73
MDM Coax and Power	74
MDM Connector Saver	75
MDM Cross Reference	76-83
• Circular Connectors	
Mil-DTL 38999 Class G	
Introduction	84
How to Order	85
KJL/KJ/KJA	
Introduction	86-88
Series I How to Order	89
Series I Connectors	90-93
Series II How to Order	94
Series II Connectors	95-96
Series III How to Order	97
Series III Connectors	98
Contact Arrangements	99-100
Contacts and Torque Values	101-102
Backshells	103-104
Tools	105
Assembly Instructions	106
• MKJ Series Connector	
Introduction	107
How to Order	108
• Filter Connectors: Chip-on-Flex	
Introduction and How to Order	109
• Fiber Optics	
Introduction	110
Application Guide	111
Design Guide	112
Product Safety and Warranty	113

Cannon Space Connectors

ITT Cannon has a long history of providing high performance D Subminiature connectors for space applications (qualified by NASA / GFSC and the European Space Agency). Space / High Reliability D*M and D*MA connectors meet stringent test for outgassing and residual magnetism and are suitable for use in space, medical, and high performance military / aerospace applications. D*M and D*MA connectors meet the performance and dimensional requirements of MIL-C-24308. The newest product group is High Density D*MA crimp connectors.

Applications

- Space - Low / High Orbit Satellites

Product Features

- Non-magnetic
- Non-outgassing
- Standard density layout: 9, 15, 25, 37, 50 contacts
- High density layout: 15, 26, 44, 62, 78, 104 contacts
- 6 shell sizes: E, A, B, C, D, F
- Machined contacts
- Machined aluminum shells available (with optional keying)



Materials and Finish

Material	Finish/Treatment
Shells	Copper Alloy Finish: 0,70 μm (28 μin) min Gold over Copper Finish: 1,27 μm (50 μin) min Gold over Copper
Insulators, and saver spacers color	High performance thermoplastic type PCT, UL 9-V0, glass filled, natural color
Female signal contacts	Housings: Copper Alloy Finish: 1,27 μm (50 μin) min Gold over Copper Clips: Beryllium Copper Alloy Finish: 1,27 μm (50 μin) min Gold over Copper
Female signal contacts	Copper Alloy Finish: 1,27 μm (50 μin) min Gold over Copper
Coaxial and power contacts	Copper Alloy Finish: 1,27 μm (50 μin) min Gold over Copper Insulator (coaxial contacts) : PTFE (Teflon)
Screwlocks	Copper Alloy Finish: 0,70 μm (28 μin) min Gold over Copper Finish: 1,27 μm (50 μin) min Gold over Copper Stainless Steel Finish: Passivated
Backshells	Copper Alloy Finish: 0,70 μm (28 μin) min Gold over Copper Finish: 1,27 μm (50 μin) min Gold over Copper
Other metal parts	Copper Alloy Finish: 0,70 μm (28 μin) min Gold over Copper Finish: 1,27 μm (50 μin) min Gold over Copper
Dust Caps	Standard: High density



Dimensions shown in mm
Specifications and dimensions subject to

www.ittcannon.com

For Crimp, Solder Cup, and PCB Type

Typical Part Number: DBM Y 25 P M NMBK52

Product Family Designator

- D*M = Solder Cup and standard density PCB
- D*A = Crimp and high density PCB
- * = Shell sizes E, A, B, C, D, or F - See Layouts

Hardware Modifier

- = 3,05mm (0.120) through hole
- Y = Dual float mount

Layouts

- Standard Density
E = 9, A = 15, B = 25, C = 37, D = 50
- High Density
E = 15, A = 26, B = 44, C = 62, D = 78, F = 104

Combo D¹

- E = 2W2, 2WK2, 5W1
- A = 3W3, 3WK3, 7W2, 11W1
- B = 5W5, 9W4, 13W3, 17W2, 21W1
- C = 8W8, 13W6, 17W5, 21WA4, 25W3, 27W2
- D = 24W7, 36W4, 43W2, 47W1

¹ All Combo-D cable side connectors use the "W" designation (without contacts installed) and contacts are ordered separately. Consult the factory for PCB Combo-D Versions.

Gender

- P = Male Plug, Pin
- S = Female, Receptacle, Socket

F size shells are available only in machined aluminum versions (K128)

Shell Modifier (Standard)²

- F225 = Stainless Steel Shell
- NMBK52 = Brass shells, 1,27 m (50 μin) Au plating
- NMBK128 = Aluminum Shell, 1,27 m (50 μin) Au/Ni plating
- NMBK128K134 = 90° PCB, Aluminum Shell with blind mounting holes, 1,27 m (50 μin) Au over Ni plating

² For keying options, please consult the factory

PC Tail Modifier (Standard)

Straight PCB

- D*M Std. Density- US Std. – 0,76mm (0.030") Ø PC tail
- E – 3,2mm (0.127") PC tail
- M – 4,0mm (0.157") PC tail
- Z – 4,64mm (0.183") PC tail

- D*M Std. Density – Euro Std. – 0,60mm (0.024") Ø PC tail
- OL3 – 4,7mm (0.185") PC tail
- OL4 – 5,4mm (0.212") PC tail

- D*MA High Density – Int'l Std. – 0,53mm (0.021") Ø PC tail
- M – 4,0mm (0.157") PC tail
- OL3 – 4,7mm (0.185") PC tail

90° PCB

- Std. Density- US Std. – 0,76mm (0.030") Ø PC tail – D*M

With Plastic Bracket

- D – 3,2mm (0.127") PC tail
- L – 4,0mm (0.157") PC tail
- S – 4,64mm (0.183") PC tail

Without Bracket

- F – 3,2mm (0.127") PC tail
- P – 4,0mm (0.157") PC tail
- R – 4,64mm (0.183") PC tail

- D*M Std. Density – Euro Std. – 0,60mm (0.024") Ø PC tail

- 1A0N – 5,0mm (0.197") PCB tail w/o bracket
- 1A7N – 4,0mm (0.157") PC tail w/ metal bracket/ 4-40 thd
- 1A9N – 4,0mm (0.157") PC tail w/ metal bracket/ M3 thd

- D*MA High Density – Int'l Std. – 0,53mm (0.021") Ø PC tail

With Plastic Bracket

- D – 3,2mm (0.127") PC tail
- L – 4,0mm (0.157") PC tail
- S – 4,64mm (0.183") PC tail

Without Bracket

- F – 3,2mm (0.127") PC tail
- P – 4,0mm (0.157") PC tail
- R – 4,64mm (0.183") PC tail
- 1CON/1DON⁴ – 5,0mm (0.197") PC tail

With Metal Bracket

- 1C7N/1D7N – 4,0mm (0.157") PC tail & 4-40 thd
- 1C9N/1D9N – 4,0mm (0.157") PC tail & M-3 thd

⁴ 1CON - Shell Size E, A, B, C
1DON - Shell Size D

Performance Specifications

Operating Temperature Range	-55°C to +125°C (-67°F to +257°F)		
Storage Temperature Range	-65°C to +125°C (-85°F to +257°F)		
Working Voltage (between contacts and contact and shells)	<u>Contact Type</u>	<u>Sea Level</u>	<u>33000 m (108,240 feet) altitude</u>
	D*M size 20	300 Vms	250 Vms
	D*M size 22	250 Vms	200 Vms
	D*M Coax	100 Vms	100 Vms (center contact to coax shell)
	D*M Coax	100 Vms	100 Vms (coax shell to connector)
	D*M Power	250 Vms	250 Vms
	D*MA size 20	300 Vms	250 Vms
	D*MA size 22	250 Vms	250 Vms
Insulation Resistance (500 V DC)	5000M min.		
Voltage Proof	1250 Vms / 2.0 mA max leakage current (Standard Density)		
	1000 Vms / 2.0 mA max leakage current (High Density)		
Contact Retention in Insert	40 N max/ contact axial displacement 0,30 mm (.011 in.) max		
Mating Force (N max)	<u>Shell Size</u>	<u>Standard Density</u>	<u>High Density</u>
	E	30	46
	A	50	77
	B	83	127
	C	123	177
	D	166	222
Unmating Force (N min / N max)	<u>Shell Size</u>	<u>Standard Density</u>	<u>High Density</u>
	E	3.5 / 20	3.4 / 28
	A	4.5 / 34	4.5 / 46
	B	8.0 / 55	7.9 / 77
	C	11.0 / 83	11.3 / 109
	D	14.5 / 120	14.7 / 136
Engagement/Separation Force	Engagement Force (Contacts size 20) : 3.33 N max, pin dia 1,04 (.041)		
	Engagement Force (Contacts size 22) : 0.33 N max, pin dia 0,775 (.031)		
	Engagement Force (Contacts size 20) : 0.28 N max, pin dia 0,99 (.039) / 2.22 N max pin dia 1,04 (.041)		
	Engagement Force (Contacts size 22) : 0.20 N max, pin dia 0,749 (.029) / 2.22 N max pin dia 0,775 (.031)		
Contact Resistance	Low level current (10 mA / 20 mV DC) : 6.0m max		
	Rated current: 5.0 m max		
Maximum Rated Current	<u>Contact Type</u>	<u>Rated Current (A)</u>	
	Size 20 solder	7.5	
	Size 20 wrap	3.0	
	Size 22 solder	5.0	
	Coax center contact	7.5	
	Power	40.0	
	Size 20/20 crimp	7.5	
	Size 20/28 crimp	3.0	
	Size 20/18 crimp	7.5	
	Size 20/22 crimp	5.0	
Residual Magnetism Level	<u>Residual Magnetism</u>	<u>Rated Current (A)</u>	
	200 Gamma	NMB	
Magnetic Permeability	Relative Permeability : 2 μ max measurement with instrument conforming to ASTM A342		

Components Matrix - D-Subminiature Space Grade Connectors

Specifications from NASA and ESA have similar requirements for quality screening and qualification. Materials are also similar, but slight variations in gold plating thicknesses exist as indicated in the table below. This table compares component materials for NASA/GSFC, ESA, and ITT Cannon Space grade D-Subminiature connector part numbers.

Piece Parts/Materials	ESA/SCC 3401	NASA/GSFC (K47/K52)	ITT NMB	FR023	FR022
Shells -Material -plating	Copper Alloy 0,7 µm Au/Cu	Copper Alloy 1,27 µm Au/Cu	Copper Alloy 1,27 µm Au/Cu	Copper Alloy 1,27 µm Au/Cu	Copper Alloy 1,27 µm Au/Cu
Signal Contacts -Material -plating	Copper Alloy 1,27 µm Au/Cu	Copper Alloy 1,27 µm Au/Cu	Copper Alloy 1,27 µm Au/Cu	Copper Alloy 1,27 µm Au/Cu	Copper Alloy 1,27 µm Au/Cu
Insulators -Material -plating	Thermx Polyester White	Thermx Polyester White	Thermx Polyester White	Thermx Polyester White	Thermx Polyester White
Saver Spacers -Material -color	PCT Natural	PCT Natural	PCT Natural	PCT Natural	PCT Natural
Coax Contacts -Insulator -Material -plating	Teflon Copper Alloy 1.27 µm Au/Cu	Teflon Copper Alloy 1.27 µm Au/Cu	Teflon Copper Alloy 1.27 µm Au/Cu	Teflon Copper Alloy 1.27 µm Au/Cu	Teflon Copper Alloy 1.27 µm Au/Cu
Power Contacts -Material -plating	Copper Alloy 0,7 µm Au/Cu	Copper Alloy 0,7 µm Au/Cu	Copper Alloy 0,7 µm Au/Cu	Copper Alloy 0,7 µm Au/Cu	Copper Alloy 0,7 µm Au/Cu
Screwlocks -Material (base) -plating (over copper) -Material (alternative)	Copper Alloy 0,7 µm Au/Cu Passivated Stainless Steel	Copper Alloy 1,27 µm Au/Cu Passivated Stainless Steel	Copper Alloy 1,27 µm Au/Cu Passivated Stainless Steel	Copper Alloy 1,27 µm Au/Cu Passivated Stainless Steel	Copper Alloy 1,27 µm Au/Cu Passivated Stainless Steel
Backshells -Material -plating	Copper Alloy 0,7 µm Au/Cu	Teflon Copper Alloy 1.27 µm Au/Cu	Teflon Copper Alloy 1.27 µm Au/Cu	Teflon Copper Alloy 1.27 µm Au/Cu	Teflon Copper Alloy 1.27 µm Au/Cu
Dust Caps -Material (standard) -Color -Material (antistatic) -Color	Polyethylene Red Polypropylene Black	Polyethylene Red Polypropylene Black	Polyethylene Red Polypropylene Black	Polyethylene Red Polypropylene Black	Polyethylene Red Polypropylene Black

ITT NMB K47/K52/K128 Specified Space Components

Piece Parts/Materials	Aluminum Shells	Swaged Hardware	Seals & Grommets
Material	Aluminum/Stainless Inserts	Copper Alloy	Silicone
Plating (over copper)	0,7 µm Au/Ni	0,7 µm Au/Cu	-

K47 indicates 1,27 µm Au over Cu plating on brass shells. Connectors are sold without contacts.

K52 indicates 1,27 µm Au over Cu plating on brass shells. Connectors are sold with contacts.

K128 indicates 1,27 µm Au over Cu plating on aluminum shells.

All components above meet requirements for residual and outgassing under NASA/GSFC and ESA requirements.

Dimensions shown in mm
Specifications and dimensions subject to

www.ittcannon.com



Plug

- For contact cavity arrangements, see pages 53-55.
- For P.C. hole pattern, see pages 56-58.
- For panel cutouts, see page 50.
- For hardware views (Standard), see page 51.

Shell Size	Layout	Through Hole	Dual Float Mount
DE	9	DEM9P0L3NM*	DEMY9P0LNM*
DA	15	DAM15P0L3NM*	DAMY15P0L3NM*
DB	25	DBM25P0L3NM*	DBMY25P0L3NM*
DC	37	DCM37P0L3NM*	DCMY37P0L3NM*
DD	50	DDM50P0L3NM*	DDMY50P0L3NM*

Note: For Residual Magnetism Level of 200 gamma, add B. Example DEM9P0L3NMB.
 For shells with 50 microinches gold, add K52. Example: DEM9P0L3NMK52.
 For alternate PC tail modifiers (see tabulation), replace 0L3 with M or Z.
 Example: DEM9PZNM

PC Tail Modifiers	X	ØY
M	4,01 ± 0,69 (.158 ± .027)	0,76 ± 0,08 (.030 ± .003)
Z	4,65 ± 0,69 (.183 ± .027)	0,76 ± 0,08 (.030 ± .003)
0L3	4,20 ± 1,10 (.185 ± .043)	0,60 ± 0,08 (.023 ± .003)

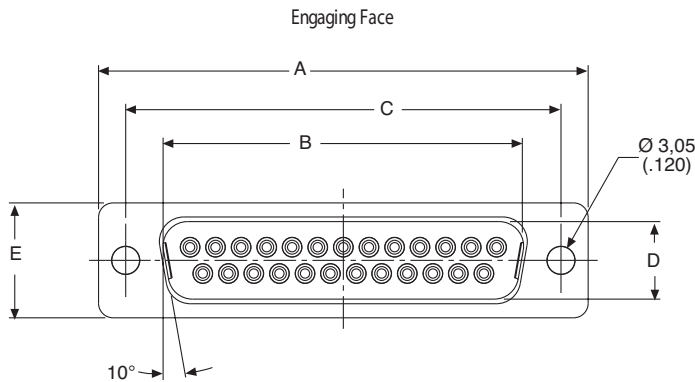

Size D

DD Configuration

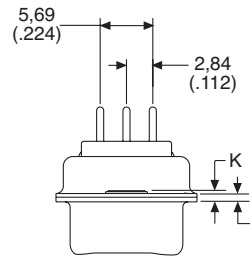

Sizes E, A, B, C

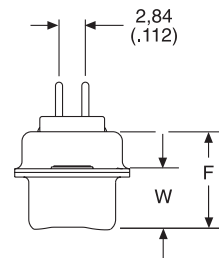
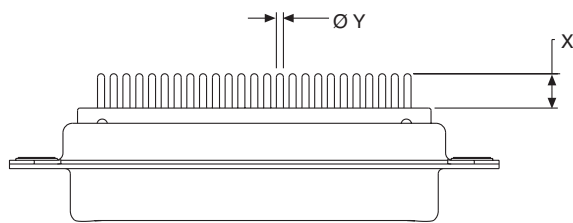

Dimensions

Shell size	A	B	C	D	E	F	W	W	K	K	L
	± 0,38 (.015)	± 0,13 (.005)	± 0,13 (.005)	± 0,13 (.005)	± 0,38 (.015)	± 0,25 (.010)	± 0,368 (.0145)	± 0,41 (.016)	± 0,317 (.0125)	± 0,25 (.010)	± 0,25 (.010)
DE	30,81 (1.213)	16,92 (.666)	24,99 (8,36)	8,36 (.329)	12,55 (.494)	10,72 (.422)	6,693 (.2635)	-	1,206 (.0475)	-	0,76 (.030)
DA	39,14 (1.541)	25,25 (.994)	33,32 (1.312)	8,36 (.329)	12,55 (.494)	10,72 (.422)	6,693 (.2635)	-	1,206 (.0475)	-	0,76 (.030)
DB	53,04 (2.088)	38,96 (1.534)	47,04 (1.852)	8,36 (.329)	12,55 (.494)	10,82 (.426)	-	6,84 (.269)	-	1,52 (.060)	0,99 (.039)
DC	69,32 (2.729)	55,42 (2.182)	63,50 (2.500)	8,36 (.329)	12,55 (.494)	10,82 (.426)	-	6,84 (.269)	-	1,52 (.060)	0,99 (.039)
DD	66,93 (2.635)	52,81 (2.079)	61,11 (2.406)	11,07 (.436)	15,37 (.605)	10,82 (.426)	-	6,84 (.269)	-	1,52 (.060)	0,99 (.039)



Dimensions shown in mm
 Specifications and dimensions subject to
www.ittcannon.com

Receptacle

- For contact cavity arrangements, see pages 53-55.
- For P.C. hole pattern, see pages 56-58.
- For panel cutouts, see page 50.
- For hardware views (Standard), see page 51.

PC Tail Modifiers	X	ØY
M	4,01 ± 0,69 (.158 ± .027)	0,76 ± 0,08 (.030 ± .003)
Z	4,65 ± 0,69 (.183 ± .027)	0,76 ± 0,08 (.030 ± .003)
0L3	4,20 ± 1,10 (.185 ± .043)	0,60 ± 0,08 (.023 ± .003)

Shell Size	Layout	Through Hole	Dual Float Mount
DE	9	DEM9S0L3NM*	DEMY9S0LNM*
DA	15	DAM15S0L3NM*	DAMY15S0L3NM*
DB	25	DBM25S0L3NM*	DBMY25S0L3NM*
DC	37	DCM37S0L3NM*	DCMY37S0L3NM*
DD	50	DDM50S0L3NM*	DDMY50S0L3NM*

Note: For Residual Magnetism Level of 200 gamma, add B. Example DEM9S0L3NMB.

For shells with 50 microinches gold, add K52. Example: DEM9S0L3NMK52.

For alternate PC tail modifiers (see tabulation), replace 0L3 with M or Z.

Example: DEM9SZNM

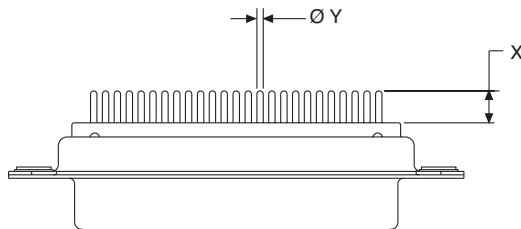
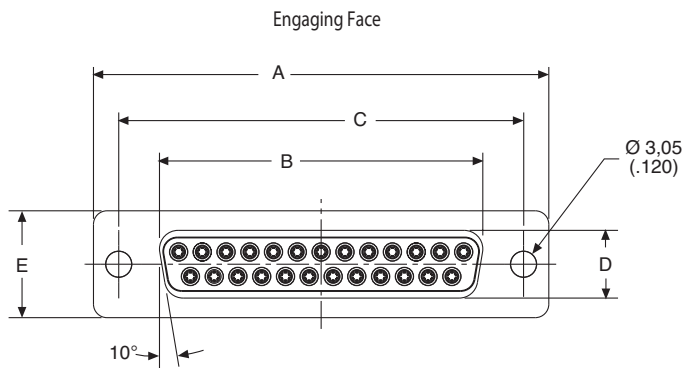

Size D

DD Configuration

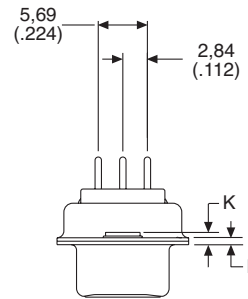

Sizes E, A, B, C

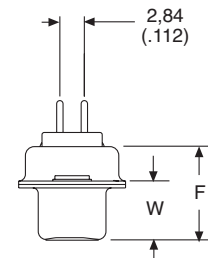

Dimensions

Shell size	A ± 0,38 (.015)	B ± 0,13 (.005)	C ± 0,13 (.005)	D ± 0,13 (.005)	E ± 0,38 (.015)	F ± 0,25 (.010)	W ± 0,368 (.0145)	K ± 0,317 (.0125)	L ± 0,25 (.010)
DE	30,81 (1.213)	16,33 (.643)	24,99 (8,36)	7,90 (.311)	12,55 (.494)	10,90 (.429)	6,94 (.273)	1,206 (.0475)	0,76 (.030)
DA	39,14 (1.541)	24,66 (.971)	33,32 (1.312)	7,90 (.311)	12,55 (.494)	10,90 (.429)	6,94 (.273)	1,206 (.0475)	0,76 (.030)
DB	53,04 (2.088)	38,38 (1.511)	47,04 (1.852)	7,90 (.311)	12,55 (.494)	10,90 (.429)	6,94 (.273)	1,206 (.0475)	0,76 (.030)
DC	69,32 (2.729)	54,84 (2.159)	63,50 (2.500)	7,90 (.311)	12,55 (.494)	10,90 (.429)	6,94 (.273)	1,206 (.0475)	0,76 (.030)
DD	66,93 (2.635)	52,42 (2.064)	61,11 (2.406)	10,74 (.423)	15,37 (.605)	10,90 (.429)	6,94 (.273)	1,206 (.0475)	0,76 (.030)

Dimensions shown in mm

Specifications and dimensions subject to

www.ittcannon.com



Plug

- For contact cavity arrangements, see pages 53-55.
- For P.C. hole pattern, see pages 56-58.
- For panel cutouts, see page 50.

Shell Size	Layout	Through Hole
DE	9	DEM9PLNM*
DA	15	DAM15PLNM*
DB	25	DBM25PLNM*
DC	37	DCM37PLNM*
DD	50	DDM50PLNM*

Note: For Residual Magnetism Level of 200 gamma, add B. Example DEM9PLNMB.
For shells with 50 microinches gold, add K52. Example: DEM9PLNMK52.

Size D

DD Configuration

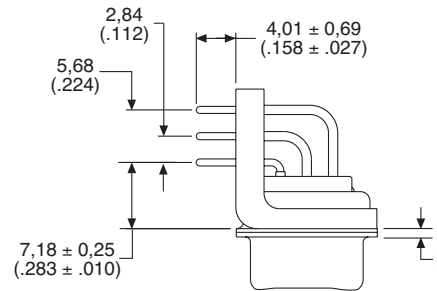
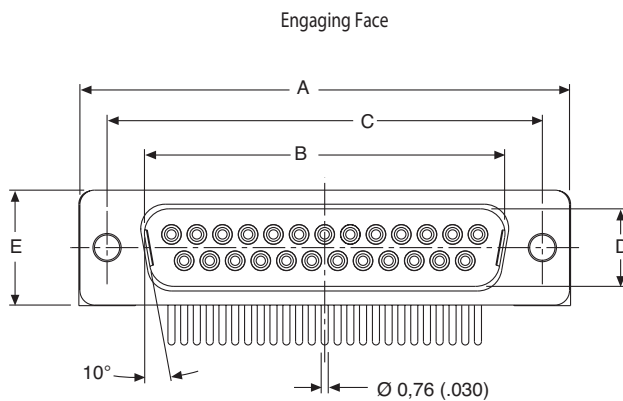

Sizes E, A, B, C

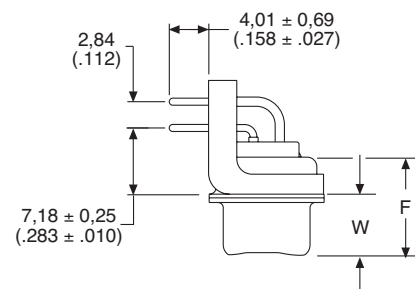
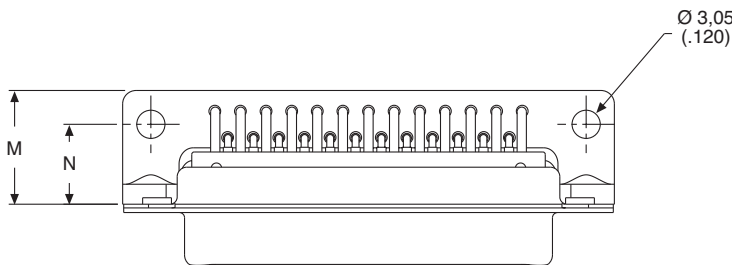

Dimensions

Shell size	A	B	C	D	E	F	W	W	K	K	L
	± 0,38 (.015)	± 0,13 (.005)	± 0,13 (.005)	± 0,13 (.005)	± 0,38 (.015)	± 0,25 (.010)	± 0,368 (.0145)	± 0,41 (.016)	± 0,317 (.0125)	± 0,25 (.010)	± 0,25 (.010)
DE	30,81 (1.213)	16,92 (.666)	24,99 (8,36)	8,36 (.329)	12,55 (.494)	10,72 (.422)	6,693 (.2635)	-	0,76 (.030)	12,30 (.484)	8,64 (.340)
DA	39,14 (1.541)	25,25 (.994)	33,32 (1.312)	8,36 (.329)	12,55 (.494)	10,72 (.422)	6,693 (.2635)	-	0,76 (.030)	12,30 (.484)	8,64 (.340)
DB	53,04 (2.088)	38,96 (1.534)	47,04 (1.852)	8,36 (.329)	12,55 (.494)	10,82 (.426)	-	6,84 (.269)	0,76 (.030)	12,30 (.484)	8,64 (.340)
DC	69,32 (2.729)	55,42 (2.182)	63,50 (2.500)	8,36 (.329)	12,55 (.494)	10,82 (.426)	-	6,84 (.269)	0,76 (.030)	12,30 (.484)	8,64 (.340)
DD	66,93 (2.635)	52,81 (2.079)	61,11 (2.406)	11,07 (.436)	15,37 (.605)	10,82 (.426)	-	6,84 (.269)	0,76 (.030)	15,09 (.594)	10,04 (.395)



Dimensions shown in mm
Specifications and dimensions subject to
www.ittcannon.com

Receptacle

- For contact cavity arrangements, see pages 53-55.
- For P.C. hole pattern, see pages 56-58.
- For panel cutouts, see page 50.

Shell Size	Layout	Through Hole
DE	9	DEM9SLNM*
DA	15	DAM15SLNM*
DB	25	DBM25SLNM*
DC	37	DCM37SLNM*
DD	50	DDM50SLNM*

Note: For Residual Magnetism Level of 200 gamma, add B. Example DEM9SLNMB.
 For shells with 50 microinches gold, add K52. Example: DEM9SLNMK52.

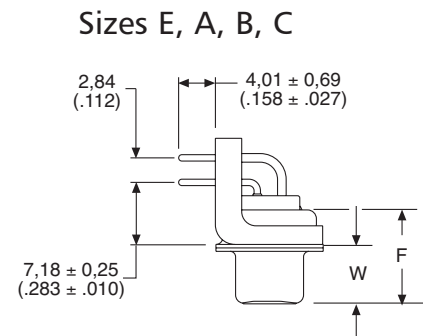
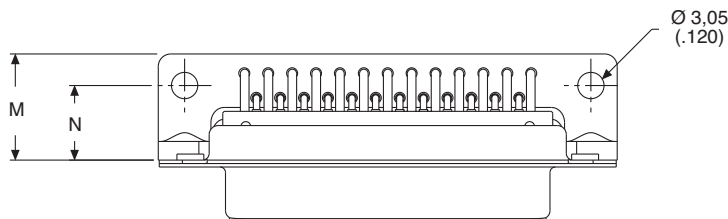
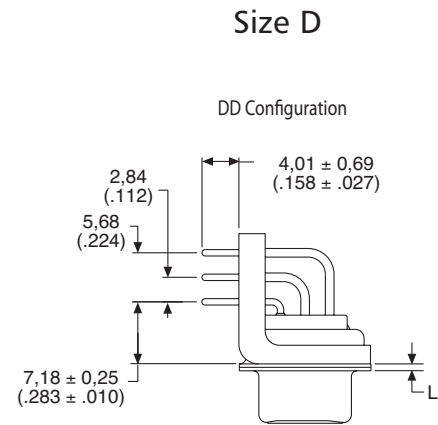
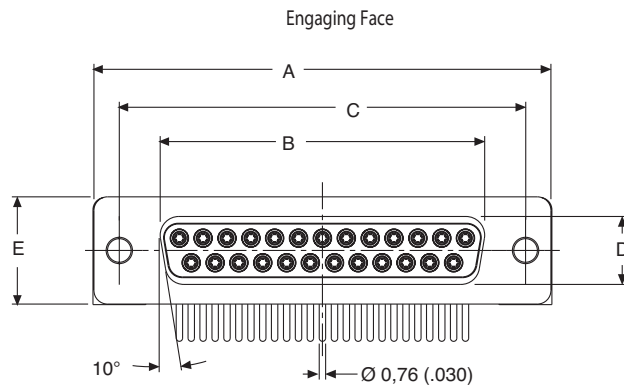

Dimensions

Shell size	A ± 0,38 (.015)	B ± 0,13 (.005)	C ± 0,13 (.005)	D ± 0,13 (.005)	E ± 0,38 (.015)	F ± 0,25 (.010)	W ± 0,368 (.0145)	L ± 0,25 (.010)	M ± 0,25 (.010)	N ± 0,13 (.005)
DE	30,81 (1.213)	16,33 (.643)	24,99 (8,36)	7,90 (.311)	12,55 (.494)	10,90 (.429)	6,94 (.273)	0,76 (.030)	12,30 (.484)	8,64 (.340)
DA	39,14 (1.541)	24,66 (.971)	33,32 (1.312)	7,90 (.311)	12,55 (.494)	10,90 (.429)	6,94 (.273)	0,76 (.030)	12,30 (.484)	8,64 (.340)
DB	53,04 (2.088)	38,38 (1.511)	47,04 (1.852)	7,90 (.311)	12,55 (.494)	10,90 (.429)	6,94 (.273)	0,76 (.030)	12,30 (.484)	8,64 (.340)
DC	69,32 (2.729)	54,84 (2.159)	63,50 (2.500)	7,90 (.311)	12,55 (.494)	10,90 (.429)	6,94 (.273)	0,76 (.030)	12,30 (.484)	8,64 (.340)
DD	66,93 (2.635)	52,42 (2.064)	61,11 (2.406)	10,74 (.423)	15,37 (.605)	10,90 (.429)	6,94 (.273)	0,76 (.030)	15,09 (.594)	10,04 (.395)

Dimensions shown in mm
 Specifications and dimensions subject to
www.ittcannon.com



Plug

- For contact cavity arrangements, see pages 53-55.
- For P.C. hole pattern, see pages 56-58.
- For panel cutouts, see page 50.
- For hardware views (European), see page 52.

Shell Size	Layout	Through Hole	Dual Float Mount
DE	9	DEM9PNM*1AON	DEMY9PNM*1AON
DA	15	DAM15PNM*1AON	DAMY15PNM*1AON
DB	25	DBM25PNM*1AON	DBMY25PNM*1AON
DC	37	DCM37PNM*1AON	DCMY37PNM*1AON
DD	50	DDM50PNM*1AON	DDMY50PNM*1AON

Note: For Residual Magnetism Level of 200 gamma, add B.
 Example DEM9PNMB1AON.
 For shells with 50 microinches gold, add K52. Example: DEM9PNM1AONK52.

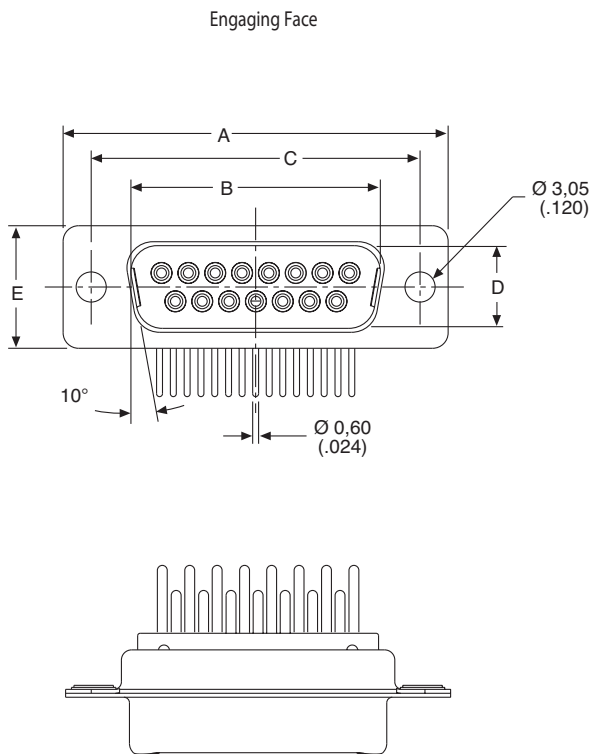

Size D

DD Configuration

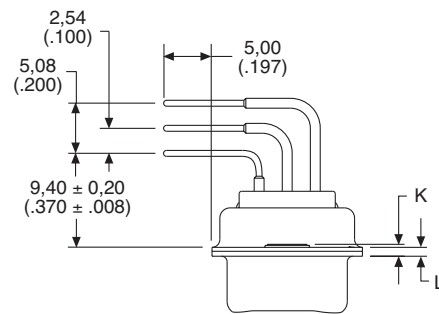

Sizes E, A, B, C

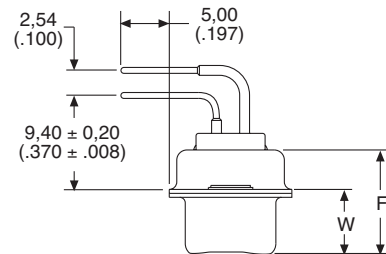

Dimensions

Shell size	A	B	C	D	E	F	W	W	K	K	L
	± 0,38 (.015)	± 0,13 (.005)	± 0,13 (.005)	± 0,13 (.005)	± 0,38 (.015)	± 0,25 (.010)	± 0,368 (.0145)	± 0,41 (.016)	± 0,317 (.0125)	± 0,25 (.010)	± 0,25 (.010)
DE	30,81 (1.213)	16,92 (.666)	24,99 (8,36)	8,36 (.329)	12,55 (.494)	10,72 (.422)	6,693 (.2635)	-	1,206 (.0475)	-	0,76 (.030)
DA	39,14 (1.541)	25,25 (.994)	33,32 (1.312)	8,36 (.329)	12,55 (.494)	10,72 (.422)	6,693 (.2635)	-	1,206 (.0475)	-	0,76 (.030)
DB	53,04 (2.088)	38,96 (1.534)	47,04 (1.852)	8,36 (.329)	12,55 (.494)	10,82 (.426)	-	6,84 (.269)	-	1,52 (.060)	0,99 (.039)
DC	69,32 (2.729)	55,42 (2.182)	63,50 (2.500)	8,36 (.329)	12,55 (.494)	10,82 (.426)	-	6,84 (.269)	-	1,52 (.060)	0,99 (.039)
DD	66,93 (2.635)	52,81 (2.079)	61,11 (2.406)	11,07 (.436)	15,37 (.605)	10,82 (.426)	-	6,84 (.269)	-	1,52 (.060)	0,99 (.039)



Dimensions shown in mm
 Specifications and dimensions subject to
www.ittcannon.com

Receptacle

- For contact cavity arrangements, see pages 53-55.
- For P.C. hole pattern, see pages 56-58.
- For panel cutouts, see page 50.
- For hardware views (European), see page 52.

Shell Size	Layout	Through Hole	Dual Float Mount
DE	9	DEM9SNM*1AON	DEMY9SNM*1AON
DA	15	DAM15SNM*1AON	DAMY15SNM*1AON
DB	25	DBM25SNM*1AON	DBMY25SNM*1AON
DC	37	DCM37SNM*1AON	DCMY37SNM*1AON
DD	50	DDM50SNM*1AON	DDMY50SNM*1AON

Note: For Residual Magnetism Level of 200 gamma, add B.

Example DEM9SNMB1AON.

For shells with 50 microinches gold, add K52. Example: DEM9SNM1AONK52.

Size D

Engaging Face

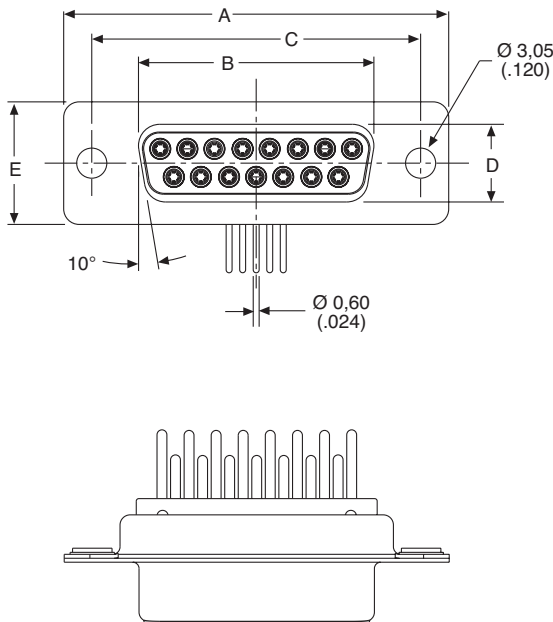

DD Configuration

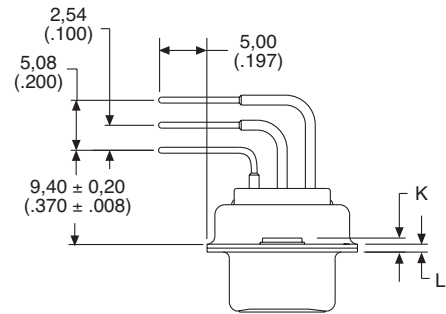

Sizes E, A, B, C

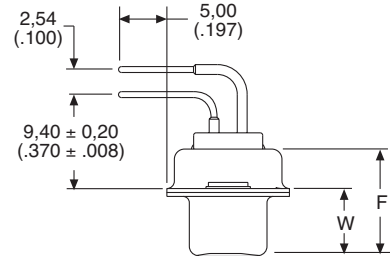

Dimensions

Shell size	A ± 0,38 (.015)	B ± 0,13 (.005)	C ± 0,13 (.005)	D ± 0,13 (.005)	E ± 0,38 (.015)	F ± 0,25 (.010)	W ± 0,368 (.0145)	K ± 0,317 (.0125)	L ± 0,25 (.010)
DE	30,81 (1.213)	16,33 (.643)	24,99 (8,36)	7,90 (.311)	12,55 (.494)	10,90 (.429)	6,94 (.273)	1,206 (.0475)	0,76 (.030)
DA	39,14 (1.541)	24,66 (.971)	33,32 (1.312)	7,90 (.311)	12,55 (.494)	10,90 (.429)	6,94 (.273)	1,206 (.0475)	0,76 (.030)
DB	53,04 (2.088)	38,38 (1.511)	47,04 (1.852)	7,90 (.311)	12,55 (.494)	10,90 (.429)	6,94 (.273)	1,206 (.0475)	0,76 (.030)
DC	69,32 (2.729)	54,84 (2.159)	63,50 (2.500)	7,90 (.311)	12,55 (.494)	10,90 (.429)	6,94 (.273)	1,206 (.0475)	0,76 (.030)
DD	66,93 (2.635)	52,42 (2.064)	61,11 (2.406)	10,74 (.423)	15,37 (.605)	10,90 (.429)	6,94 (.273)	1,206 (.0475)	0,76 (.030)

Dimensions shown in mm
Specifications and dimensions subject to

www.ittcannon.com



Plug

- For contact cavity arrangements, see pages 53-55.
- For P.C. hole pattern, see pages 56-58.
- For panel cutouts, see page 50.
- For hardware views (European), see page 52.

Shell Size	Layout	Metal Bracket Threaded Insert #4-40	Metal Bracket Threaded Insert M3
DE	9	DEM9PNM*1A7N	DEM9PNMB*1A9N
DA	15	DAM15PNM*1A7N	DAM15PNMB*1A9N
DB	25	DBM25PNM*1A7N	DBM25PMB*1A9N
DC	37	DCM37PNM*1A7N	DCM37PNMB*1A9N
DD	50	DDM50PNM*1A7N	DDM50PNMB*1A9N

Note: For Residual Magnetism Level of 200 gamma, add B.
 Example DEM9PNMB1A7N.
 For shells with 50 microinches gold, add K52. Example: DEM9PNM1A7NK52.

Size D

DD Configuration

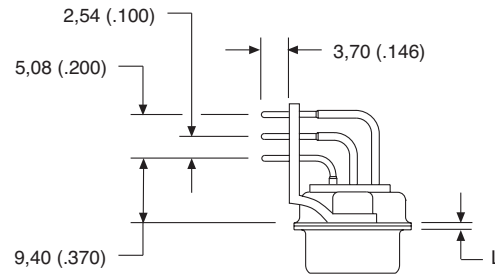
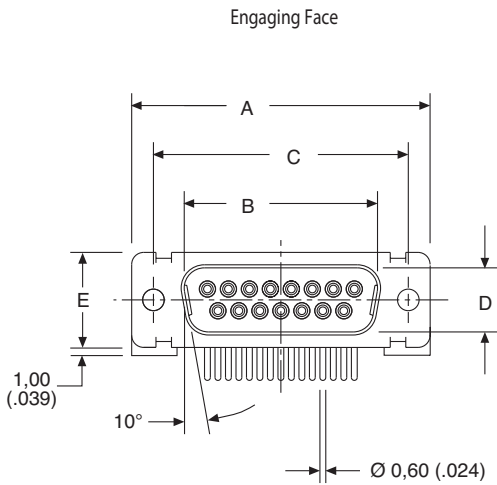

Sizes E, A, B, C

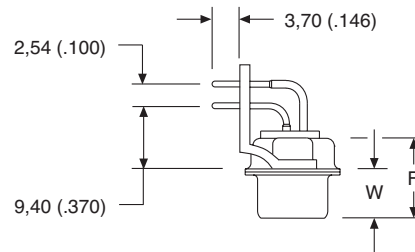
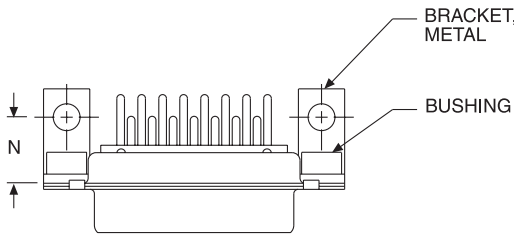

Dimensions

Shell size	A	B	C	D	E	F	W	W	L	N
	± 0,38 (.015)	± 0,13 (.005)	± 0,13 (.005)	± 0,13 (.005)	± 0,38 (.015)	± 0,25 (.010)	± 0,368 (.0145)	± 0,41 (.016)	± 0,25 (.010)	± 0,15 (.006)
DE	30,81 (1.213)	16,92 (.666)	24,99 (8,36)	8,36 (.329)	12,55 (.494)	10,72 (.422)	6,693 (.2635)	-	0,76 (.030)	10,7 (.42)
DA	39,14 (1.541)	25,25 (.994)	33,32 (1.312)	8,36 (.329)	12,55 (.494)	10,72 (.422)	6,693 (.2635)	-	0,76 (.030)	10,7 (.42)
DB	53,04 (2.088)	38,96 (1.534)	47,04 (1.852)	8,36 (.329)	12,55 (.494)	10,82 (.426)	-	6,84 (.269)	0,99 (-.039)	10,7 (.42)
DC	69,32 (2.729)	55,42 (2.182)	63,50 (2.500)	8,36 (.329)	12,55 (.494)	10,82 (.426)	-	6,84 (.269)	0,99 (-.039)	10,7 (.42)
DD	66,93 (2.635)	52,81 (2.079)	61,11 (2.406)	11,07 (.436)	15,37 (.605)	10,82 (.426)	-	6,84 (.269)	0,99 (-.039)	10,7 (.42)



Receptacle

- For contact cavity arrangements, see pages 53-55.
- For P.C. hole pattern, see pages 56-58.
- For panel cutouts, see page 50.
- For hardware views (Standard), see page 51.

Shell Size	Layout	Metal Bracket Threaded Insert #4-40	Metal Bracket Threaded Insert M3
DE	9	DEM9SNM*1A7N	DEM9SNMB*1A7N
DA	15	DAM15SNM*1A7N	DAM15SNMB*1A7N
DB	25	DBM25SNM*1A7N	DBM25SNMB*1A7N
DC	37	DCM37SNM*1A7N	DCM37SNMB*1A7N
DD	50	DDM50SNM*1A7N	DDM50SNMB*1A7N

Note: For Residual Magnetism Level of 200 gamma, add B.
 Example DEM9SNMB1A7N.
 For shells with 50 microinches gold, add K52. Example: DEM9SNM1A7NK52.

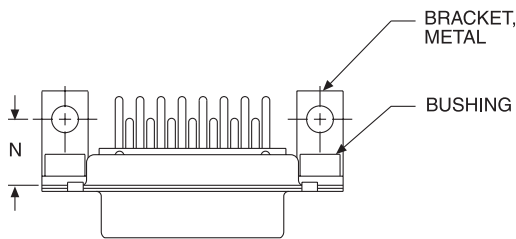
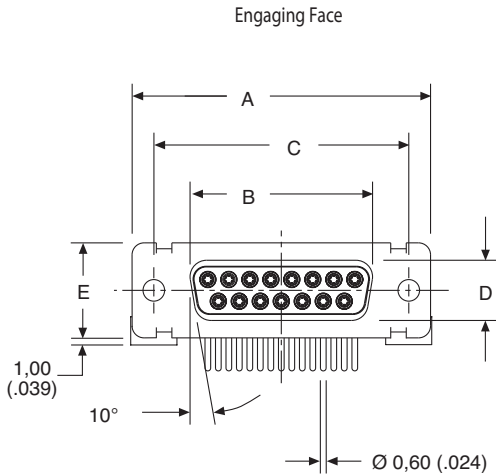

Size D

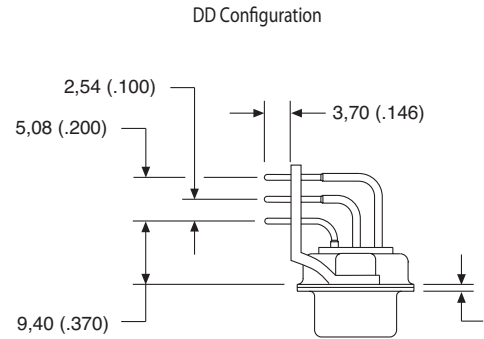

Sizes E, A, B, C

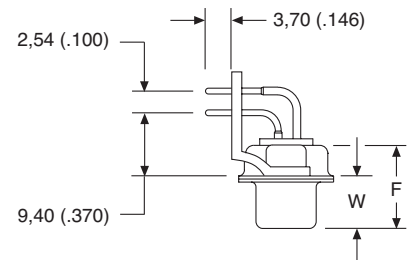

Dimensions

Shell size	A	B	C	D	E	F	W	L	N
	± 0,38 (.015)	± 0,13 (.005)	± 0,13 (.005)	± 0,13 (.005)	± 0,38 (.015)	± 0,25 (.010)	± 0,368 (.0145)	± 0,25 (.010)	± 0,15 (.006)
DE	30,81 (1.213)	16,92 (.666)	24,99 (8,36)	8,36 (.329)	12,55 (.494)	10,90(.429)	6.94 (.273)	0,76 (.030)	10,7 (.42)
DA	39,14 (1.541)	25,25 (.994)	33,32 (1.312)	8,36 (.329)	12,55 (.494)	10,90(.429)	6.94 (.273)	0,76 (.030)	10,7 (.42)
DB	53,04 (2.088)	38,96 (1.534)	47,04 (1.852)	8,36 (.329)	12,55 (.494)	10,90(.429)	6.94 (.273)	0,99 (-.039)	10,7 (.42)
DC	69,32 (2.729)	55,42 (2.182)	63,50 (2.500)	8,36 (.329)	12,55 (.494)	10,90(.429)	6.94 (.273)	0,99 (-.039)	10,7 (.42)
DD	66,93 (2.635)	52,81 (2.079)	61,11 (2.406)	11,07 (.436)	15,37 (.605)	10,90(.429)	6.94 (.273)	0,99 (-.039)	12,1 (.48)

Plug

- For contact cavity arrangements, see pages 53-55.
- For panel cutouts, see page 50.
- For hardware views (Standard), see page 51.

Shell Size	Layout	Through Hole	Dual Float Mount
DE	9	DEM9PNM*	DEMY9PNM*
DA	15	DAM15PNM*	DAMY15PNNM*
DB	25	DBM25PNM*	DBMY25PM*
DC	37	DCM37PNM*	DCMY37PNM*
DD	50	DDM50PNM*	DDMY50PNM*

Note: For Residual Magnetism Level of 200 gamma, add B. Example DEM9PNMB
For shells with 50 microinches gold, add K52. Example: DEM9PNMK52

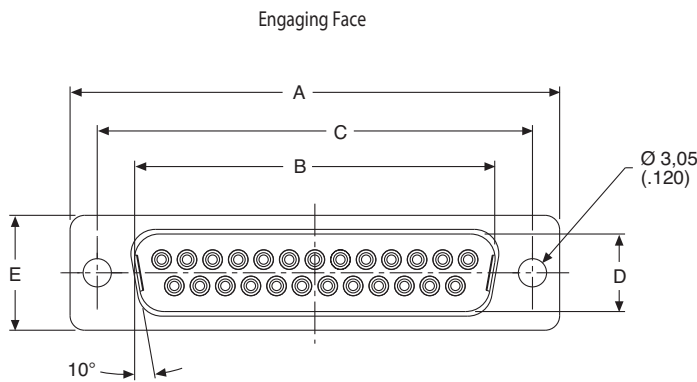

Size D

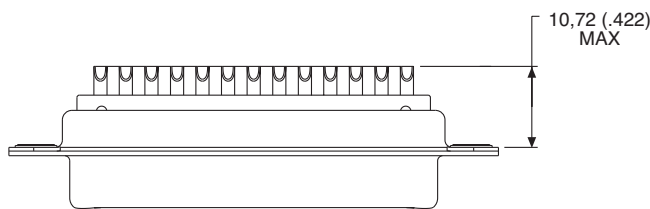
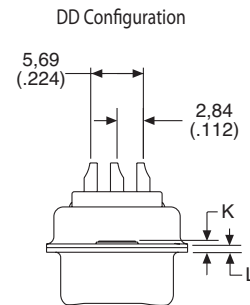

Sizes E, A, B, C

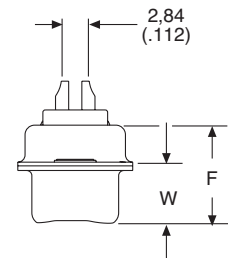

Dimensions

Shell size	A	B	C	D	E	F	W	W	K	K	L
DE	± 0,38 (.015)	± 0,13 (.005)	± 0,13 (.005)	± 0,13 (.005)	± 0,38 (.015)	± 0,25 (.010)	± 0,368 (.0145)	± 0,41 (.016)	± 0,317 (.0125)	± 0,25 (.010)	± 0,25 (.010)
DA	30,81 (1.213)	16,92 (.666)	24,99 (8,36)	8,36 (.329)	12,55 (.494)	10,72 (.422)	6,693 (.2635)	-	1,206 (.0475)	-	0,76 (.030)
DB	39,14 (1.541)	25,25 (.994)	33,32 (1.312)	8,36 (.329)	12,55 (.494)	10,72 (.422)	6,693 (.2635)	-	1,206 (.0475)	-	0,76 (.030)
DC	53,04 (2.088)	38,96 (1.534)	47,04 (1.852)	8,36 (.329)	12,55 (.494)	10,82 (.426)	-	6,84 (.269)	-	1,52 (.060)	0,99 (.039)
DD	69,32 (2.729)	55,42 (2.182)	63,50 (2.500)	8,36 (.329)	12,55 (.494)	10,82 (.426)	-	6,84 (.269)	-	1,52 (.060)	0,99 (.039)
DD	66,93 (2.635)	52,81 (2.079)	61,11 (2.406)	11,07 (.436)	15,37 (.605)	10,82 (.426)	-	6,84 (.269)	-	1,52 (.060)	0,99 (.039)



Dimensions shown in mm
Specifications and dimensions subject to
www.ittcannon.com

Receptacle

- For contact cavity arrangements, see pages 53-55.
- For panel cutouts, see page 50.
- For hardware views (Standard), see page 51.

Shell Size	Layout	Through Hole	Dual Float Mount
DE	9	DEM9SNM*	DEMY9SNM*
DA	15	DAM15SNM*	DAMY15SNM*
DB	25	DBM25SNM*	DBMY25SM*
DC	37	DCM37SNM*	DCMY37SNM*
DD	50	DDM50SNM*	DDMY50SNM*

Note: For Residual Magnetism Level of 200 gamma, add B. Example DEM9SNMB.
 For shells with 50 microinches gold, add K52. Example: DEM9SNMK52.

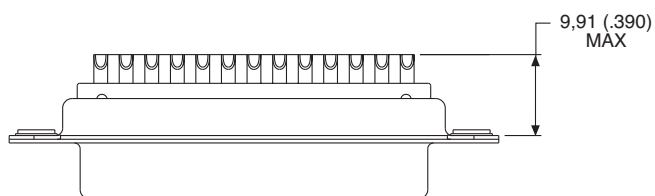
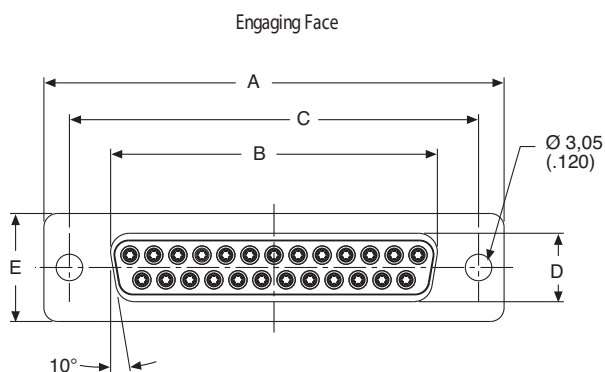

Size D

DD Configuration

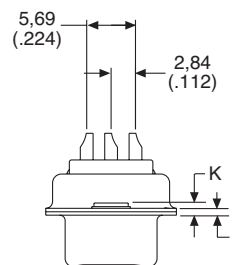

Sizes E, A, B, C

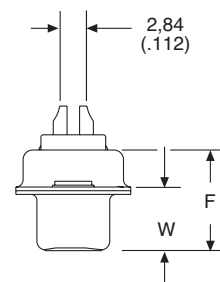

Dimensions

Shell size	A	B	C	D	E	F	W	K	L
	± 0,38 (.015)	± 0,13 (.005)	± 0,13 (.005)	± 0,13 (.005)	± 0,38 (.015)	± 0,25 (.010)	± 0,368 (.0145)	± 0,317 (.0125)	± 0,25 (.010)
DE	30,81 (1.213)	16,33 (.643)	24,99 (8,36)	7,90 (.311)	12,55 (.494)	10,90 (.429)	6,94 (.273)	1,206 (.0475)	0,76 (.030)
DA	39,14 (1.541)	24,66 (.971)	33,32 (1.312)	7,90 (.311)	12,55 (.494)	10,90 (.429)	6,94 (.273)	1,206 (.0475)	0,76 (.030)
DB	53,04 (2.088)	38,38 (1.511)	47,04 (1.852)	7,90 (.311)	12,55 (.494)	10,90 (.429)	6,94 (.273)	1,206 (.0475)	0,76 (.030)
DC	69,32 (2.729)	54,84 (2.159)	63,50 (2.500)	7,90 (.311)	12,55 (.494)	10,90 (.429)	6,94 (.273)	1,206 (.0475)	0,76 (.030)
DD	66,93 (2.635)	52,42 (2.064)	61,11 (2.406)	10,74 (.423)	15,37 (.605)	10,90 (.429)	6,94 (.273)	1,206 (.0475)	0,76 (.030)

Dimensions shown in mm
 Specifications and dimensions subject to
www.ittcannon.com



Plug

- For contact cavity arrangements, see pages 53-55.
- For panel cutouts, see page 50.
- For hardware views (Standard), see page 51.

Shell Size	Layout	Through Hole	Dual Float Mount
DE	9	DEMA9PNM*	DEMAY9PNM*
DA	15	DAMA15PNM*	DAMAY15PNM*
DB	25	DBMA25PNM*	DBMAY25PM*
DC	37	DCMA37PNM*	DCMAY37PNM*
DD	50	DDMA50PNM*	DDMAY50PNM*

Note: For Residual Magnetism Level of 200 gamma, add B. Example DEMA9PNMB
 For shells with 50 microinches gold, add K52. Example: DEMA9PNMK52.
 For connectors without contacts, add F0. Example: DEMA9PNMF0 (F0 not marked on the connector)
 For crimp (Size 20) contacts and tooling, see page 33.

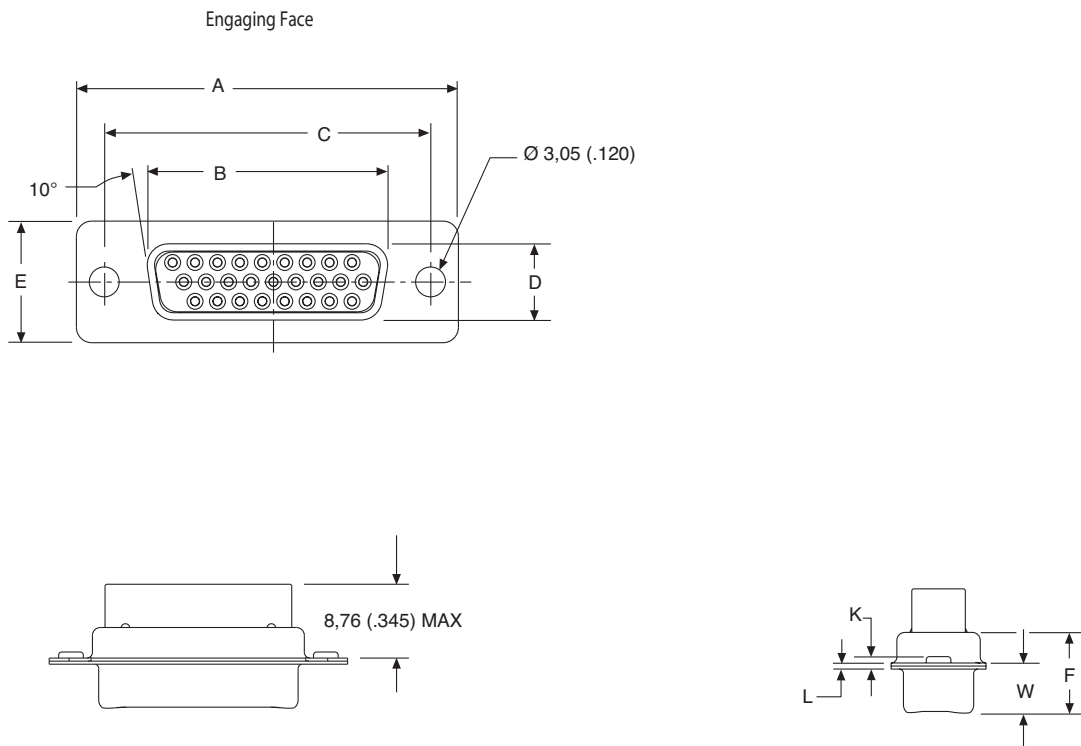

Dimensions

Shell size	A	B	C	D	E	F	W	W	K	K	L
	± 0,38 (.015)	± 0,13 (.005)	± 0,13 (.005)	± 0,13 (.005)	± 0,38 (.015)	± 0,25 (.010)	± 0,368 (.0145)	± 0,41 (.016)	± 0,317 (.0125)	± 0,25 (.010)	± 0,25 (.010)
DE	30,81 (1.213)	16,92 (.666)	24,99 (8,36)	8,36 (.329)	12,55 (.494)	10,72 (.422)	6,693 (.2635)	-	1,206 (.0475)	-	0,76 (.030)
DA	39,14 (1.541)	25,25 (.994)	33,32 (1.312)	8,36 (.329)	12,55 (.494)	10,72 (.422)	6,693 (.2635)	-	1,206 (.0475)	-	0,76 (.030)
DB	53,04 (2.088)	38,96 (1.534)	47,04 (1.852)	8,36 (.329)	12,55 (.494)	10,82 (.426)	-	6,84 (.269)	-	1,52 (.060)	0,99 (.039)
DC	69,32 (2.729)	55,42 (2.182)	63,50 (2.500)	8,36 (.329)	12,55 (.494)	10,82 (.426)	-	6,84 (.269)	-	1,52 (.060)	0,99 (.039)
DD	66,93 (2.635)	52,81 (2.079)	61,11 (2.406)	11,07 (.436)	15,37 (.605)	10,82 (.426)	-	6,84 (.269)	-	1,52 (.060)	0,99 (.039)



Dimensions shown in mm
 Specifications and dimensions subject to
www.ittcannon.com

Receptacle

- For contact cavity arrangements, see pages 53-55.
- For panel cutouts, see page 50.
- For hardware views (Standard), see page 51.

Shell Size	Layout	Through Hole	Dual Float Mount
DE	9	DEMA9SNM*	DEMAY9SNM*
DA	15	DAMA15SNM*	DAMAY15SNM*
DB	25	DBMA25SNM*	DBMAY25SM*
DC	37	DCMA37SNM*	DCMAY37SNM*
DD	50	DDMA50SNM*	DDMAY50SNM*

Note: For Residual Magnetism Level of 200 gamma, add B. Example DEMA9SNMB
 For shells with 50 microinches gold, add K52. Example: DEMA9SNMK52.
 For connectors without contacts, add F0. Example: DEMA9SNMF0 (F0 not marked on the connector)
 For crimp (Size 20) contacts and tooling, see page 33.

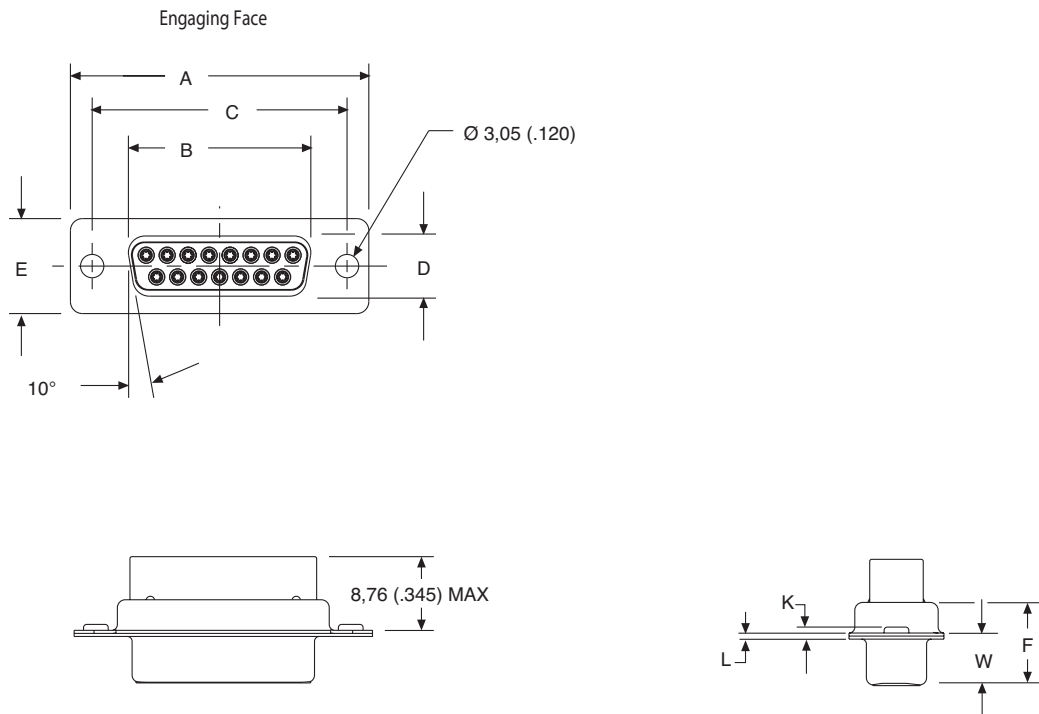

Dimensions

Shell size	A ± 0,38 (.015)	B ± 0,13 (.005)	C ± 0,13 (.005)	D ± 0,13 (.005)	E ± 0,38 (.015)	F ± 0,25 (.010)	W ± 0,368 (.0145)	K ± 0,317 (.0125)	L ± 0,25 (.010)
DE	30,81 (1.213)	16,33 (.643)	24,99 (8,36)	7,90 (.311)	12,55 (.494)	10,90 (.429)	6,94 (.273)	1,206 (.0475)	0,76 (.030)
DA	39,14 (1.541)	24,66 (.971)	33,32 (1.312)	7,90 (.311)	12,55 (.494)	10,90 (.429)	6,94 (.273)	1,206 (.0475)	0,76 (.030)
DB	53,04 (2.088)	38,38 (1.511)	47,04 (1.852)	7,90 (.311)	12,55 (.494)	10,90 (.429)	6,94 (.273)	1,206 (.0475)	0,76 (.030)
DC	69,32 (2.729)	54,84 (2.159)	63,50 (2.500)	7,90 (.311)	12,55 (.494)	10,90 (.429)	6,94 (.273)	1,206 (.0475)	0,76 (.030)
DD	66,93 (2.635)	52,42 (2.064)	61,11 (2.406)	10,74 (.423)	15,37 (.605)	10,90 (.429)	6,94 (.273)	1,206 (.0475)	0,76 (.030)

Dimensions shown in mm
 Specifications and dimensions subject to
www.ittcannon.com



Plug

- For contact cavity arrangements, see page 53-55.
- For panel cutouts, see page 50.
- For hardware views (Standard), see page 51.

Shell Size	Layout	Dual	
		Through Hole	Float Mount
DE	15	DEMA15PNM*	DEMAY15PNM*
DA	26	DAMA26PNM*	DAMAY26PNM*
DB	44	DBMA44PNM*	DBMAY44PNM*
DC	62	DCMA62PNM*	DCMAY62PNM*
DD	78	DDMA78PNM*	DDMAY78PNM*

Note: For Residual Magnetism Level of 200 gamma, add B. Example DEMA15PNMB
 For shells with 50 microinches gold, add K52. Example: DEMA15PNMK52.
 For connectors without contacts, add F0. Example: DEMA15PNMF0 (F0 not marked on connector)
 For crimp (Size 22) contacts and tooling, see page 33.

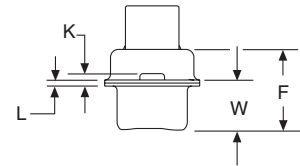
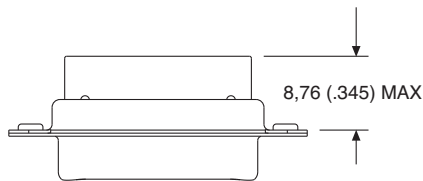
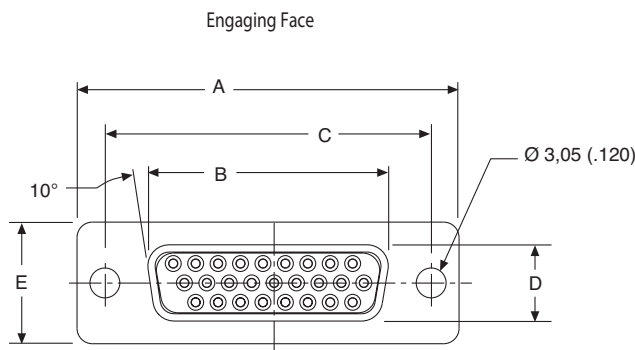

Dimensions

Shell size	A ± 0,38 (.015)	B ± 0,13 (.005)	C ± 0,13 (.005)	D ± 0,13 (.005)	E ± 0,38 (.015)	F ± 0,25 (.010)	W ± 0,368 (.0145)	K ± 0,317 (.0125)	L ± 0,25 (.010)
DE	30,81 (1.213)	16,33 (.643)	24,99 (8,36)	7,90 (.311)	12,55 (.494)	10,90 (.429)	6,94 (.273)	1,206 (.0475)	0,76 (.030)
DA	39,14 (1.541)	24,66 (.971)	33,32 (1.312)	7,90 (.311)	12,55 (.494)	10,90 (.429)	6,94 (.273)	1,206 (.0475)	0,76 (.030)
DB	53,04 (2.088)	38,38 (1.511)	47,04 (1.852)	7,90 (.311)	12,55 (.494)	10,90 (.429)	6,94 (.273)	1,206 (.0475)	0,76 (.030)
DC	69,32 (2.729)	54,84 (2.159)	63,50 (2.500)	7,90 (.311)	12,55 (.494)	10,90 (.429)	6,94 (.273)	1,206 (.0475)	0,76 (.030)
DD	66,93 (2.635)	52,42 (2.064)	61,11 (2.406)	10,74 (.423)	15,37 (.605)	10,90 (.429)	6,94 (.273)	1,206 (.0475)	0,76 (.030)

Dimensions shown in mm
 Specifications and dimensions subject to
www.ittcannon.com



Receptacle

- For contact cavity arrangements, see pages 53-55.
- For panel cutouts, see page
- For hardware views (Standard), see page 51.

Shell Size	Layout	Through Hole	Dual Float Mount
		DE	15
DA	26	DAMA26SNM*	DAMAY26SNM*
DB	44	DBMA44SNM*	DBMAY44SNM*
DC	62	DCMA62SNM*	DCMAY62SNM*
DD	78	DDMA78SNM*	DDMAY78SNM*

Note: For Residual Magnetism Level of 200 gamma, add B. Example DEMA15SNMB
 For shells with 50 microinches gold, add K52. Example: DEMA15SNMK52.
 For connectors without contacts, add F0. Example: DEMA15SNMF0 (F0 not marked on the connector)
 For crimp (Size 22) contacts and tooling, see page 33.

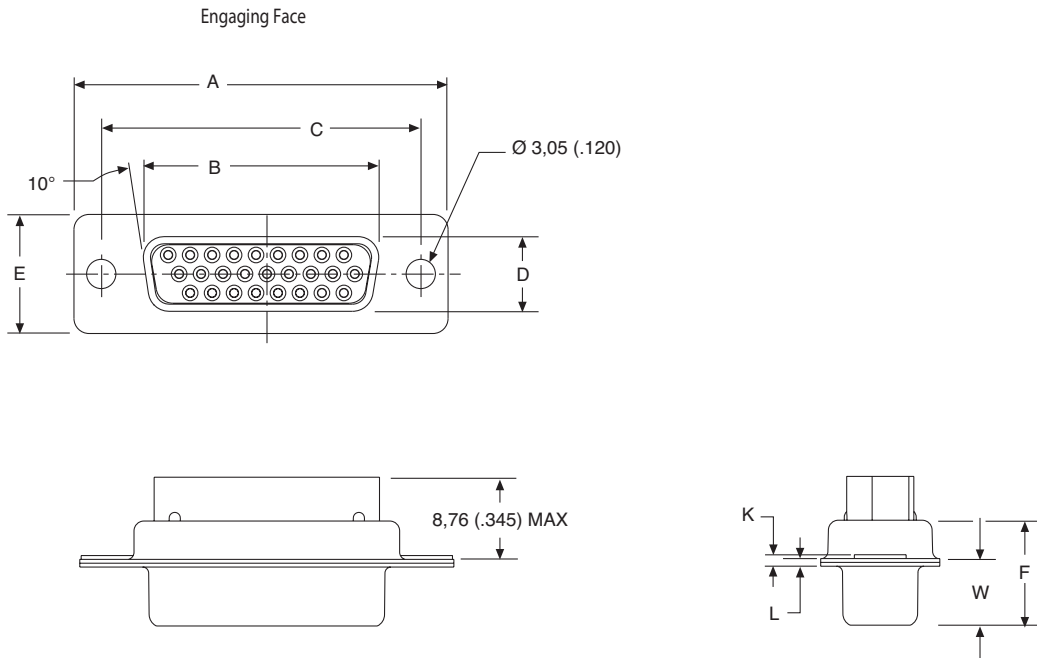

Dimensions

Shell size	A	B	C	D	E	F	W	W	K	K	L
	± 0,38 (.015)	± 0,13 (.005)	± 0,13 (.005)	± 0,13 (.005)	± 0,38 (.015)	± 0,25 (.010)	± 0,368 (.0145)	± 0,41 (.016)	± 0,317 (.0125)	± 0,25 (.010)	± 0,25 (.010)
DE	30,81 (1.213)	16,92 (.666)	24,99 (0,98)	8,36 (.329)	12,55 (.494)	10,72 (.422)	6,693 (.2635)	-	1,206 (.0475)	-	0,76 (.030)
DA	39,14 (1.541)	25,25 (.994)	33,32 (1.312)	8,36 (.329)	12,55 (.494)	10,72 (.422)	6,693 (.2635)	-	1,206 (.0475)	-	0,76 (.030)
DB	53,04 (2.088)	38,96 (1.534)	47,04 (1.852)	8,36 (.329)	12,55 (.494)	10,82 (.426)	-	6,84 (.269)	-	1,52 (.060)	0,99 (.039)
DC	69,32 (2.729)	55,42 (2.182)	63,50 (2.500)	8,36 (.329)	12,55 (.494)	10,82 (.426)	-	6,84 (.269)	-	1,52 (.060)	0,99 (.039)
DD	66,93 (2.635)	52,81 (2.079)	61,11 (2.406)	11,07 (.436)	15,37 (.605)	10,82 (.426)	-	6,84 (.269)	-	1,52 (.060)	0,99 (.039)



Dimensions shown in mm
 Specifications and dimensions subject to

www.ittcannon.com

90° Bent PCB solder Terminations / Without Brackets / European Footprint

Specific Dimensions

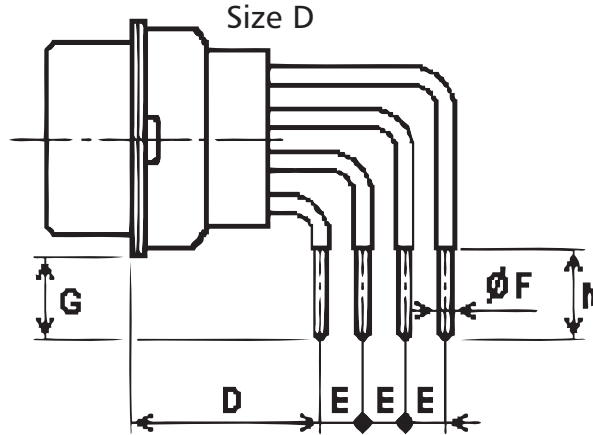
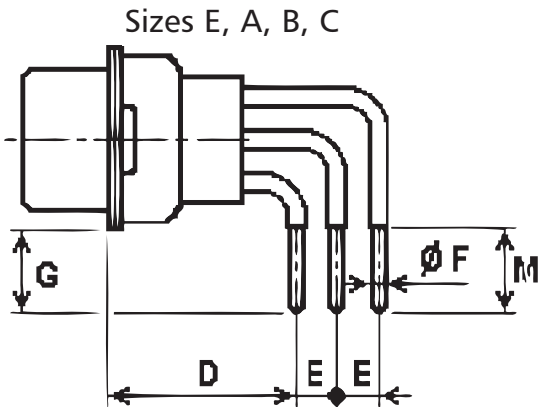

Termination Modifier	F ±0,07 (.003)	E Typical
1C0N	0,57 (0.22)	1,98 (.078)
1D0N	0,57 (0.22)	2,08 (.082)
R	0,57 (0.22)	1,98 (.078)

Contacts	Shell Size	D min	D max	G ±0,30 (.012)	M min	Pitch between contacts
Male	E	11,98 (.472)	12,48 (.491)	5,00 (.197)	5,30 (.209)	2,29 (.090)
	A	11,98 (.472)	12,48 (.491)	5,00 (.197)	5,30 (.209)	2,29 (.090)
	B	12,18 (.480)	12,68 (.499)	5,00 (.197)	5,30 (.209)	2,29 (.090)
	C	12,18 (.480)	12,68 (.499)	5,00 (.197)	5,30 (.209)	2,41 (.095)
Female	D	12,18 (.480)	12,68 (.499)	5,00 (.197)	5,30 (.209)	2,41 (.095)
	E	11,98 (.472)	12,48 (.491)	5,00 (.197)	5,30 (.209)	2,29 (.090)
	A	11,98 (.472)	12,48 (.491)	5,00 (.197)	5,30 (.209)	2,29 (.090)
	B	11,98 (.472)	12,48 (.491)	5,00 (.197)	5,30 (.209)	2,29 (.090)
	C	11,98 (.472)	12,48 (.491)	5,00 (.197)	5,30 (.209)	2,41 (.095)
	D	11,98 (.472)	12,48 (.491)	5,00 (.197)	5,30 (.209)	2,41 (.095)

Termination Modifier: 1C0N, 1D0N
 For other termination modifiers, please consult the factory

Weights

	Shell Size	Male Contact	Female Contact
Max Weight (grams) per contact		0.19	0.21
Max Weight (grams) of all contacts per size	E	2.85	3.15
	A	4.94	5.46
	B	8.36	9.24
	C	11.78	13.02
	D	14.82	16.38

Dimensions shown in mm
 Specifications and dimensions subject to

www.ittcannon.com



90° Bent PCB solder Terminations / With Brackets

Specific Dimensions

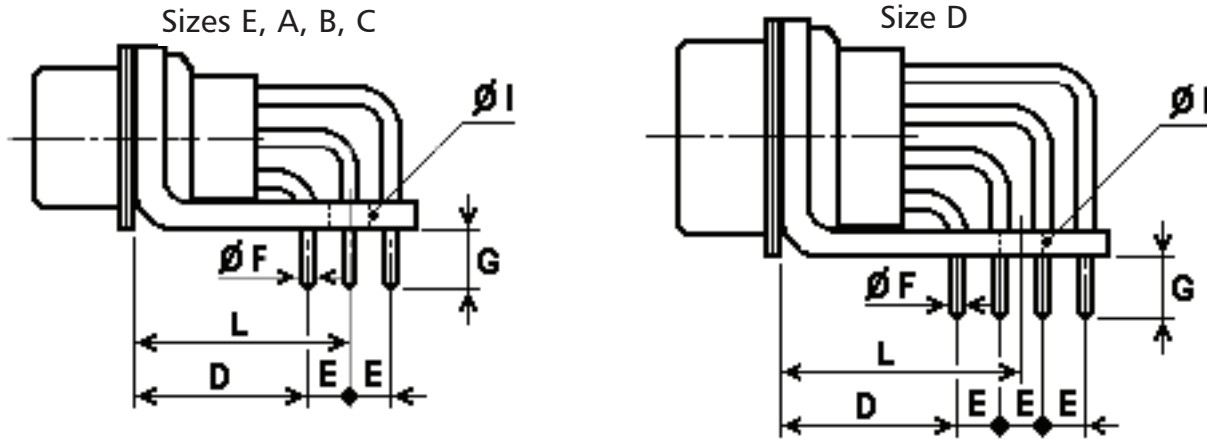

Termination Modifier	F ±0,05 (.002)	G ±0,50 (.020)
D	0,51 (.020)	3,21 (.126)

Contacts	Shell Size	D min	D max	L ±0,17 (.007)	Pitch between contacts
Male	E	11,18 (.440)	11,68 (.460)	1,98 (.078)	2,29 (.090)
	A	11,18 (.440)	11,68 (.460)	1,98 (.078)	2,29 (.090)
	B	11,18 (.440)	11,68 (.460)	1,98 (.078)	2,29 (.090)
	C	11,18 (.440)	11,68 (.460)	1,98 (.078)	2,41 (.095)
Female	E	11,18 (.440)	11,68 (.460)	1,98 (.078)	2,29 (.090)
	A	11,18 (.440)	11,68 (.460)	1,98 (.078)	2,29 (.090)
	B	11,18 (.440)	11,68 (.460)	1,98 (.078)	2,29 (.090)
	C	11,18 (.440)	11,68 (.460)	1,98 (.078)	2,41 (.095)
D	11,18 (.440)	11,68 (.460)	2,08 (.082)	2,41 (.095)	2,41 (.095)

Termination Modifier: D
 For other termination modifiers, please consult the factory

Weights

	Shell Size	Male Contact	Female Contact	Brackets + Strap
Max Weight (grams) per contact		0.19	0.21	
Max Weight (grams) of all contacts per size	E	2.85	3.15	4.54
	A	4.94	5.46	4.66
	B	8.36	9.24	4.82
	C	11.78	13.02	5.00
	D	14.82	16.38	5.71



90° Bent PCB solder Terminations / With Brackets

Specific Dimensions

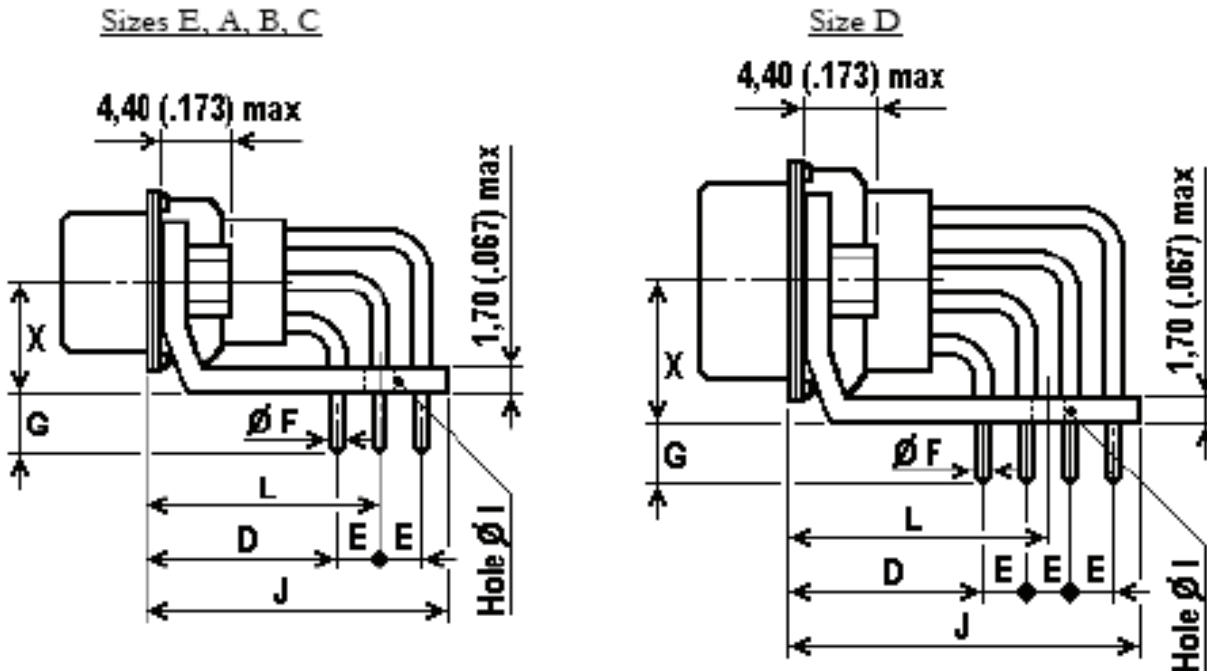

Termination Modifier	F ±0,07 (.003)	E Typical
1C7N	0,57 (.022)	1,98 (.078)
1D7N	0,57 (.022)	2,08 (.082)
1C9N	0,57 (.022)	1,98 (.078)
1D9N	0,57 (.022)	2,08 (.082)

2 pieces metal brackets:
 7N: fixed with captive nuts 4-40 UNC-2B
 9N: fixed with captive nuts M3
 Oval hole 1 : 3,22 (.127) ± 0,10 (.004)
 x 4,90 (.193) ± 0,10 (.004)
 Bracket width (onto PCB): 5,70 (.224) max

Contacts	Shell Size	D min	D max	G ±0,30 (.012)	J Max	L Typical	X ±0,10 (.004)	Pitch between contacts
Male	E	11,98 (.472)	12,48 (.491)	4,00 (.157)	18,30 (.720)	14,21 (.559)	7,35 (.559)	2,29 (.090)
	A	11,98 (.472)	12,48 (.491)	4,00 (.157)	18,30 (.720)	14,21 (.559)	7,35 (.559)	2,29 (.090)
	B	12,18 (.480)	12,68 (.499)	4,00 (.157)	18,30 (.720)	14,21 (.559)	7,35 (.559)	2,29 (.090)
	C	12,18 (.480)	12,68 (.499)	4,00 (.157)	18,30 (.720)	14,21 (.559)	7,35 (.559)	2,41 (.095)
Female	D	12,18 (.480)	12,68 (.499)	4,00 (.157)	18,30 (.720)	15,55 (.612)	8,70 (.343)	2,41 (.095)
	E	11,98 (.472)	12,48 (.491)	4,00 (.157)	18,30 (.720)	14,21 (.559)	7,35 (.559)	2,29 (.090)
	A	11,98 (.472)	12,48 (.491)	4,00 (.157)	18,30 (.720)	14,21 (.559)	7,35 (.559)	2,29 (.090)
	B	11,98 (.472)	12,48 (.491)	4,00 (.157)	18,30 (.720)	14,21 (.559)	7,35 (.559)	2,29 (.090)
	C	11,98 (.472)	12,48 (.491)	4,00 (.157)	18,30 (.720)	14,21 (.559)	7,35 (.559)	2,41 (.095)
D	11,98 (.472)	12,48 (.491)	4,00 (.157)	20,50 (.807)	15,35 (.604)	8,70 (.343)	2,41 (.095)	

Termination Modifier: 1C7N, 1D7N, 1C9N, 1D9N
 For other termination modifiers, please consult the factory.
Weights

	Shell Size	Male Contact	Female Contact
Max Weight (grams) per contact		0.19	0.21
Max Weight (grams) of all contacts per size	E	2.85	3.15
	A	4.94	5.46
	B	8.36	9.24
	C	11.78	13.02
	D	14.82	16.38
Max Weight (grams) of Brackets	Sizes E A, B, C	3,80	3,80
	Size D	4,10	4,10

Dimensions shown in mm
 Specifications and dimensions subject to
www.ittcannon.com



Straight PCB solder Terminations

Specific Dimensions

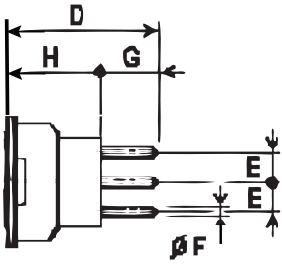

OL3 / Sizes E, A, B, C

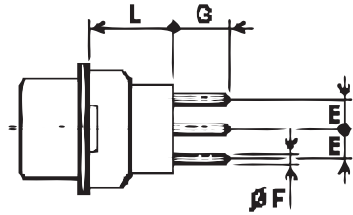

M / Sizes E, A, B, C

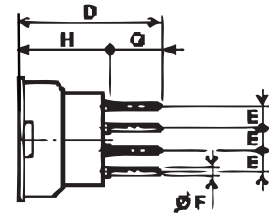

OL3 / Size D

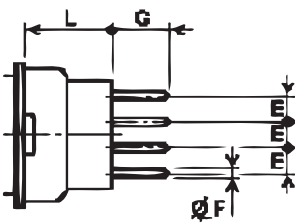

M / Size D

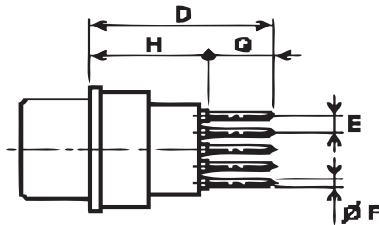

Termination type OL3 shell size F

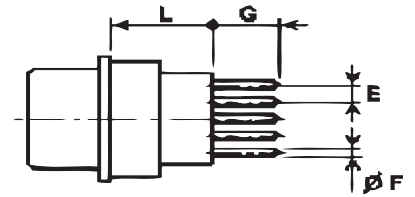

Termination Type M shell size F

Termination Modifier	F ±0,07 (.003)	G
OL3	0,57 (.022)	4,70 (.185) ± 0,1 (.004)
M	0,51 (.021)	4,00 (.157) ± 0,5 (.020)

Contacts	Shell Size	D max	H max	L max	E Typical	Pitch between contacts
Male	E	16,01 (.630)	11,21 (.441)	9,53 (.375)	1,98 (.078)	2,29 (.090)
	A	16,01 (.630)	11,21 (.441)	9,53 (.375)	1,98 (.078)	2,29 (.090)
	B	16,01 (.630)	11,41 (.449)	9,53 (.375)	1,98 (.078)	2,29 (.090)
	C	16,21 (.638)	11,41 (.449)	9,53 (.375)	1,98 (.078)	2,41 (.095)
Female	D	16,21 (.638)	11,41 (.449)	9,53 (.375)	2,08 (.062)	2,41 (.095)
	E	16,01 (.630)	11,37 (.448)	9,53 (.375)	1,98 (.078)	2,29 (.090)
	A	16,01 (.630)	11,37 (.448)	9,53 (.375)	1,98 (.078)	2,29 (.090)
	B	16,01 (.630)	11,37 (.448)	9,53 (.375)	1,98 (.078)	2,29 (.090)
	C	16,21 (.638)	11,37 (.448)	9,53 (.375)	1,98 (.078)	2,41 (.095)
	D	16,21 (.638)	11,37 (.448)	9,53 (.375)	2,08 (.062)	2,41 (.095)

Termination Modifier: OL3, M

For other termination modifiers, please consult the factory

Weights

	Shell Size	Male Contact	Female Contact
Max Weight (grams) per contact		0.17	0.20
Max Weight (grams) of all contacts per size	E	2.55	3.00
	A	4.42	5.20
	B	7.48	8.80
	C	10.64	12.40
	D	13.26	15.60



Dimensions shown in mm
Specifications and dimensions subject to

www.ittcannon.com

Product Features

- Connectors used as the connector savers in equipment applications where more than normal mating and unmating would soon degrade permanently mounted connector.
- Features the LITTLE CAESAR rear release contact retention assembly, making it field repairable.
- Normally supplied with contacts installed, it can be supplied without contacts (suffix F0 in the description, not marked on the connector).
- Male/Female type contacts, size 20 for standard density, size 22 for high density.
- Packaging unit: 1 piece (plastic bag)

Specific Dimensions

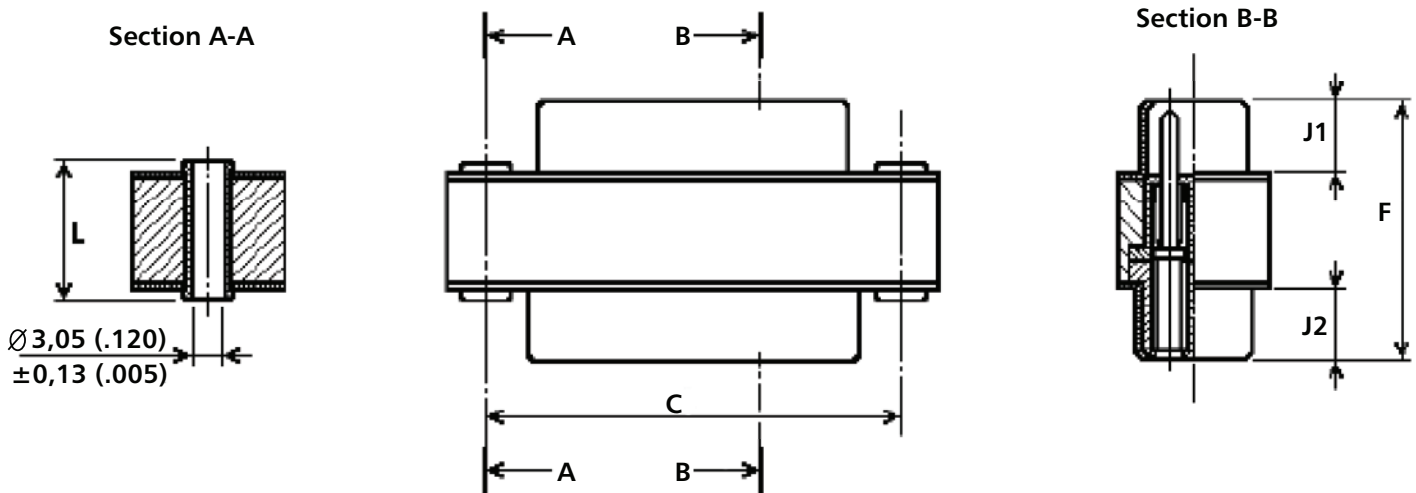

Shell Size	C ± 0,13 (.005)	F ± 0,25 (.010)	J1 ± **	J2 ± 0,13 (.005)	L ± 0,38 (.015)
E	24,99 (.984)	21,87 (.861)	5,94 (.234)*	6,18 (.243)	10,59 (.417)
A	33,32 (1.312)	21,87 (.861)	5,94 (.234)	6,18 (.243)	10,59 (.417)
B	47,04 (1.852)	21,97 (.865)	5,84 (.230)**	6,18 (.243)	10,59 (.417)
C	63,50 (2.500)	21,97 (.865)	5,84 (.230)**	6,18 (.243)	10,59 (.417)
D	61,11 (2.408)	21,97 (.865)	5,84 (.230)**	6,18 (.243)	10,59 (.417)

* ± 0,12 (.005)

** ± 0,15 (.006)

Weights

	Shell Size	Standard Density without contacts	Standard Density with contacts	High Density without contacts	High Density with contacts
Max Weight (grams) per contact			0.25		0.16
Max Weight (grams) of all contacts per size	E	9.90	12.15	9.50	11.90
	A	13.70	17.45	13.20	17.36
	B	18.40	24.65	17.80	24.84
	C	23.90	33.15	23.20	33.12
	D	26.80	39.30	26.10	38.58

Dimensions shown in mm
Specifications and dimensions subject to

www.ittcannon.com



Plug

- For contact cavity arrangements, see page 53-55.
- For panel cutouts, see page 50.
- For hardware views (Standard), see page 51.

Shell Size	Layout	Through Hole	Dual Float Mount
DE	2W2	DEM2W2PNM*	DEMY2W2PNM*
DE	2WK2	DEM2WK2PNM*	DEMY2WK2PNM*
DE	5W1	DEM5W1PNM*	DEMY5W1PNM*
DA	7W2	DAM7W2PNM*	DAMY7W2PNM*
DA	11W1	DAM11W1PNM*	DAMY11W1PNM*
DA	3W3	DAM3W3PNM*	DAMY3W3PNM*
DA	3WK3**	DAM3WK3PNM*	DAMY3WK3PNM*
DB	5W5	DBM5W5PNM*	DBMY5W5PNM*
DB	9W4	DBM9W4PNM*	DBMY9W4PNM*
DB	13W3	DBM13W3PNM*	DBMY13W3PNM*
DB	17W2	DBM17W2PNM*	DBMY17W2PNM*
DB	21W1	DBM21W1PNM*	DBMY21W1PNM*
DC	8W8	DCM8W8PNM*	DCMY8W8PNM*
DC	13W6	DCM13W6PNM*	DCMY13W6PNM*
DC	17W5	DCM17W5PNM*	DCMY17W5PNM*
DC	21WA4	DCM21WA4PNM*	DCMY21WA4PNM*
DC	25W3	DCM25W3PNM*	DCMY25W3PNM*
DC	27W2	DCM27W2PNM*	DCMY27W2PNM*
DD	24W7	DDM24W7PNM*	DDMY24W7PNM*
DD	36W4	DDM36W4PNM*	DDMY36W4PNM*
DD	43W2	DDM43W2PNM*	DDMY43W2PNM*
DD	47W1	DDM47W1PNM*	DDMY47W1PNM*

Notes: * For Residual Magnetism Level of 200 gamma, add B. Example: DEM5W1PNMB
 For shells with 50 microinches gold, add K52. Example: DEM5W1PNMK52
 ** Keyed

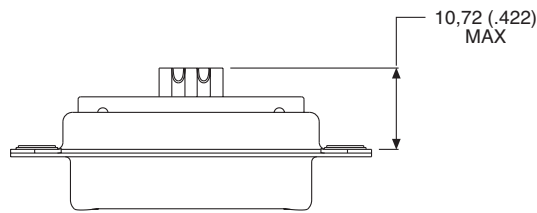
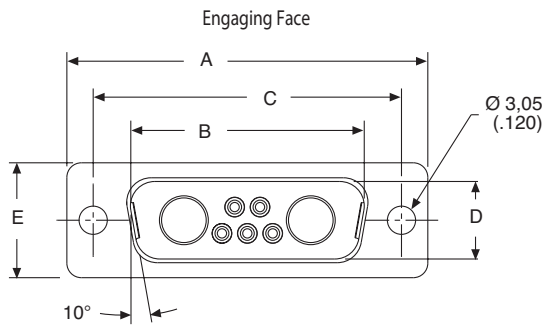

Size D

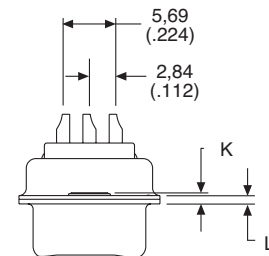

Sizes E, A, B, C

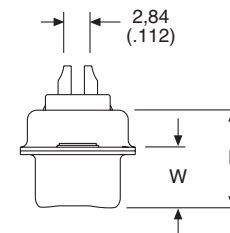

Dimensions

Shell size	A	B	C	D	E	F	W	W	K	K	L
	± 0,38 (.015)	± 0,13 (.005)	± 0,13 (.005)	± 0,13 (.005)	± 0,38 (.015)	± 0,25 (.010)	± 0,368 (.0145)	± 0,41 (.016)	± 0,317 (.0125)	± 0,25 (.010)	± 0,25 (.010)
DE	30,81 (1.213)	16,92 (.666)	24,99 (8,36)	8,36 (.329)	12,55 (.494)	10,72 (.422)	6,693 (.2635)	-	1,206 (.0475)	-	0,76 (.030)
DA	39,14 (1.541)	25,25 (.994)	33,32 (1.312)	8,36 (.329)	12,55 (.494)	10,72 (.422)	6,693 (.2635)	-	1,206 (.0475)	-	0,76 (.030)
DB	53,04 (2.088)	38,96 (1.534)	47,04 (1.852)	8,36 (.329)	12,55 (.494)	10,82 (.426)	-	6,84 (.269)	-	1,52 (.060)	0,99 (.039)
DC	69,32 (2.729)	55,42 (2.182)	63,50 (2.500)	8,36 (.329)	12,55 (.494)	10,82 (.426)	-	6,84 (.269)	-	1,52 (.060)	0,99 (.039)
DD	66,93 (2.635)	52,81 (2.079)	61,11 (2.406)	11,07 (.436)	15,37 (.605)	10,82 (.426)	-	6,84 (.269)	-	1,52 (.060)	0,99 (.039)



Dimensions shown in mm
 Specifications and dimensions subject to

www.ittcannon.com

Receptacle

- For contact cavity arrangements, see pages 53-55.
- For panel cutouts, see page 50.
- For hardware views (Standard), see page 51.

Shell Size	Layout	Through Hole	Dual Float Mount
DE	2W2	DEM2W2SNM*	DEMY2W2SNM*
DE	2WK2	DEM2WK2SNM*	DEMY2WK2SNM*
DE	5W1	DEM5W1SNM*	DEMY5W1SNM*
DA	7W2	DAM7W2SNM*	DAMY7W2SNM*
DA	11W1	DAM11W1SNM*	DAMY11W1SNM*
DA	3W3	DAM3W3SNM*	DAMY3W3SNM*
DA	3WK3**	DAM3WK3SNM*	DAMY3WK3SNM*
DB	5W5	DBM5W5SNM*	DBMY5W5SNM*
DB	9W4	DBM9W4SNM*	DBMY9W4SNM*
DB	13W3	DBM13W3SNM*	DBMY13W3SNM*
DB	17W2	DBM17W2SNM*	DBMY17W2SNM*
DB	21W1	DBM21W1SNM*	DBMY21W1SNM*
DC	8W8	DCM8W8SNM*	DCMY8W8SNM*
DC	13W6	DCM13W6SNM*	DCMY13W6SNM*
DC	17W5	DCM17W5SNM*	DCMY17W5SNM*
DC	21WA4	DCM21WA4SNM*	DCMY21WA4SNM*
DC	25W3	DCM25W3SNM*	DCMY25W3SNM*
DC	27W2	DCM27W2SNM*	DCMY27W2SNM*
DD	24W7	DDM24W7SNM*	DDMY24W7SNM*
DD	36W4	DDM36W4SNM*	DDMY36W4SNM*
DD	43W2	DDM43W2SNM*	DDMY43W2SNM*
DD	47W1	DDM47W1SNM*	DDMY47W1SNM*

Notes: * For Residual Magnetism Level of 200 gamma, add B. Example: DEM5W1SNMB
 For shells with 50 microinches gold, add K52. Example: DEM5W1SNMK52
 ** Keyed

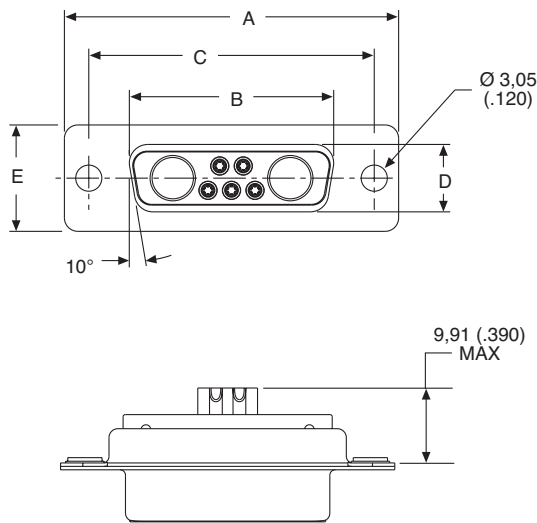

Size D

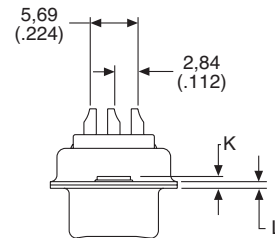

Sizes E, A, B, C

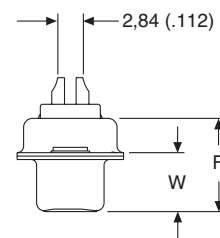

Dimensions

Shell size	A ± 0,38 (.015)	B ± 0,13 (.005)	C ± 0,13 (.005)	D ± 0,13 (.005)	E ± 0,38 (.015)	F ± 0,25 (.010)	W ± 0,38 (.015)	K ± 0,318 (.015)	L ± 0,25 (.010)
DE	30,81 (1.213)	16,92 (.666)	24,99 (8,36)	8,36 (.329)	12,55 (.494)	10,90 (.429)	6,94 (.273)	1,206 (.0475)	0,76 (.030)
DA	39,14 (1.541)	25,25 (.994)	33,32 (1.312)	8,36 (.329)	12,55 (.494)	10,90 (.429)	6,94 (.273)	1,206 (.0475)	0,76 (.030)
DB	53,04 (2.088)	38,96 (1.534)	47,04 (1.852)	8,36 (.329)	12,55 (.494)	10,90 (.429)	6,94 (.273)	1,206 (.0475)	0,76 (.030)
DC	69,32 (2.729)	55,42 (2.182)	63,50 (2.500)	8,36 (.329)	12,55 (.494)	10,90 (.429)	6,94 (.273)	1,206 (.0475)	0,76 (.030)
DD	66,93 (2.635)	52,81 (2.079)	61,11 (2.406)	11,07 (.436)	15,37 (.605)	10,90 (.429)	6,94 (.273)	1,206 (.0475)	0,76 (.030)

Dimensions shown in mm
 Specifications and dimensions subject to

Machined Aluminum Shell Versions with Optional Polarization Keying



As requirements for weight reduction and reducing the possibility of misconnects during testing and final assembly became paramount, ITT Cannon answered the call for further weight reductions by introducing machined aluminum shells with optional keys. This high stress aluminum alloy, coupled with heavy, non-magnetic, nickel under plate to a gold over plate, achieved both significant weight savings and improved strength. In addition, keys can be ordered with the connectors to provide assurance of connections during both testing and final assembly.

There are eight key locations available for customer selection that can customize similar connectors to allow the customer the ability for absolute differentiation of connectors that are of the same gender and layout, removing the possibility of wrong connections when mated to similar keyed connectors of the opposite gender. The keys are designated by adding up to four letters to the base part designation, denoting separate key locations as shown.

KEY IDENTIFIERS

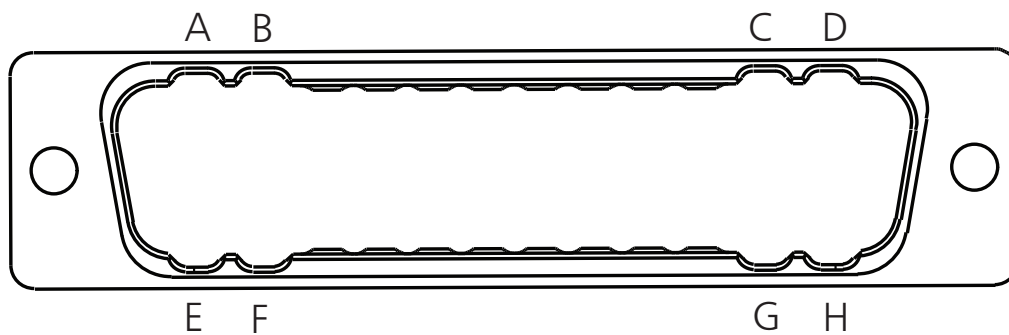

RECEPTACLE - SOCKET

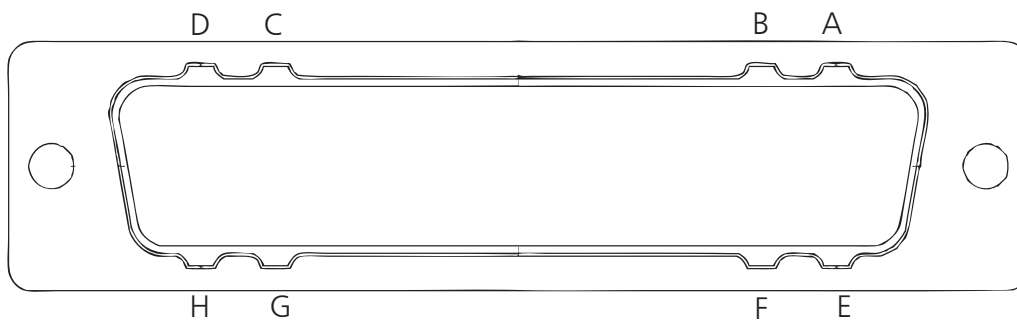

PLUG - PIN

Weight Comparisons - Brass and Aluminum Shells

Shell Size	Std/ High Density	Aluminum Shell	Brass Shell	% Savings
E	9/15	3.9	4.5	15.4
A	15/26	5.4	6.2	14.8
B	25/44	8.1	9.4	16.0
C	37/62	10.3	11.5	11.7
D	50/78	12.3	13.3	8.1
F	/104	14.2	15.8	11.3

Standard Density and High Density configurations

All connectors intermate with standard D-Subminiature connectors manufactured in accordance with NASA/ESA Dimensions.

Solder Cup

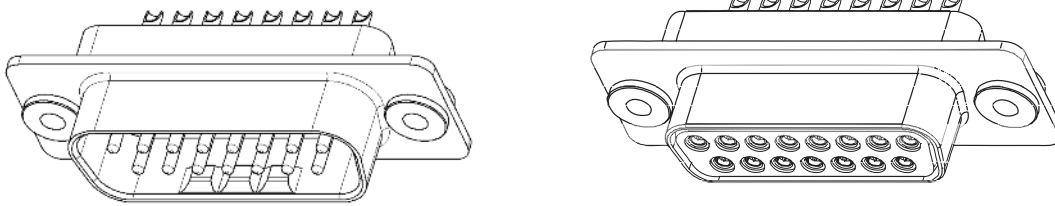

Crimp with Optional Grommet

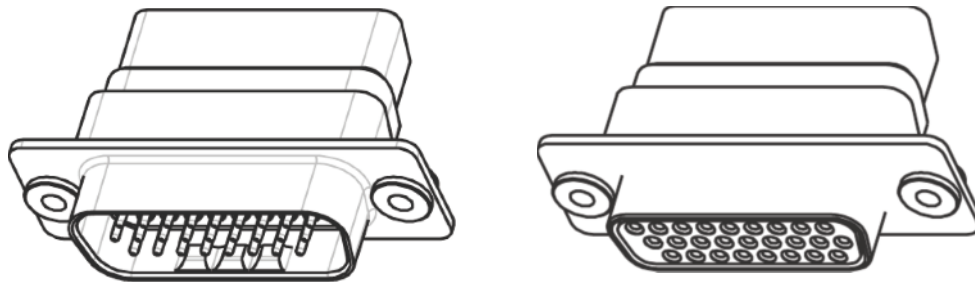

Straight PCB

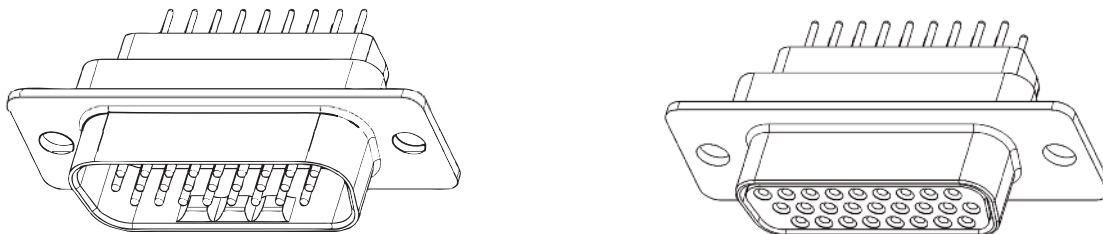

90° PCB



Optional keying available on all versions, please contact factory or authorized ITT Cannon representative.



Specific Dimensions - Standard Density

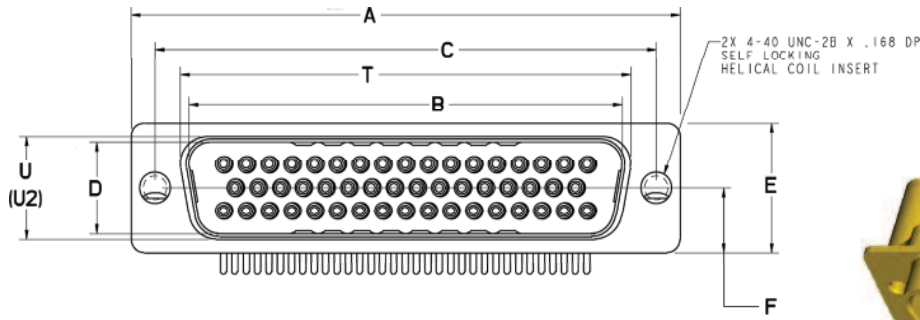

Plug - Pin

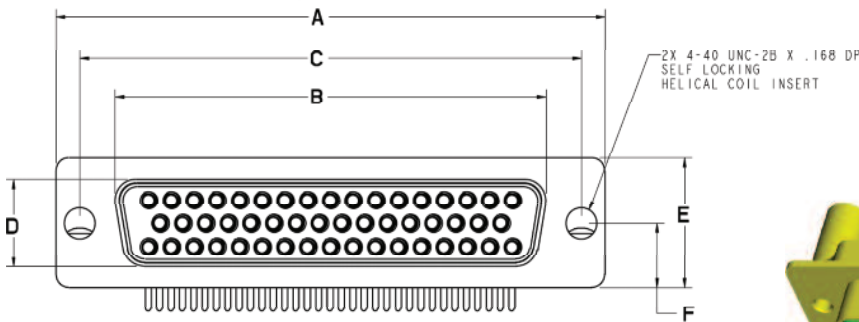
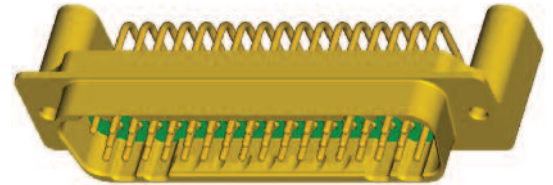

Receptacle - Socket

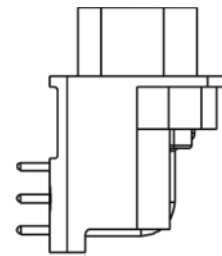
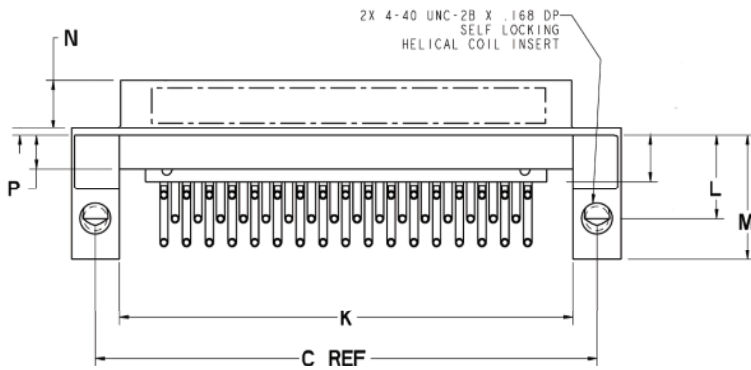
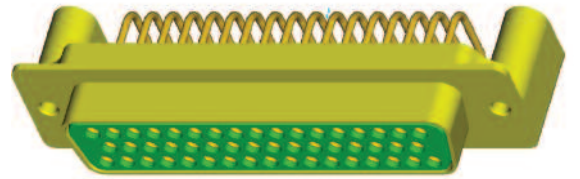

All K134 Connectors mate with standard ITT space D-Subminiature connectors built to NASA/GSFC/ESA dimensions.

Dimensions

Shell Size	Contacts	A	B	C	D	E
E	15	30,73 (1.21)	24,89 (0.98)	12,45 (0.49)	13,46 (0.53)	18,80 (0.74)
A	26	39,12 (1.54)	33,27 (1.31)	12,45 (0.49)	13,46 (0.53)	18,80 (0.74)
B	44	55,63 (2.09)	46,99 (1.85)	12,45 (0.49)	13,46 (0.53)	18,80 (0.74)
C	62	69,34 (2.73)	63,50 (2.50)	12,45 (0.49)	13,46 (0.53)	18,80 (0.74)
D	78	67,10 (2.64)	61,21 (2.41)	15,49 (0.61)	14,48 (0.57)	20,07 (0.79)
F	104	69,34 (2.73)	63,50 (2.50)	15,49 (0.61)	14,48 (0.57)	20,07 (0.79)

Dimensions shown in mm

Specifications and dimensions subject to

www.ittcannon.com



Specific Dimensions - High Density

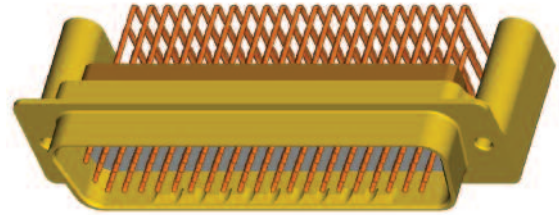
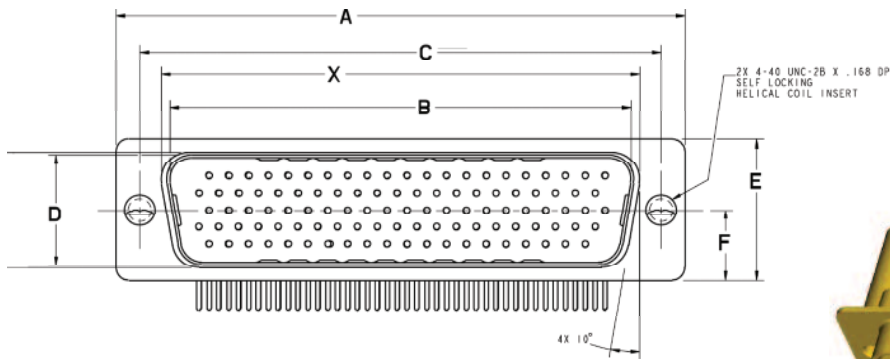

Plug - Pin

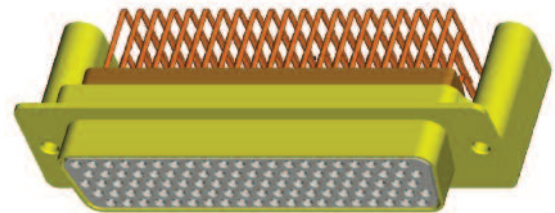
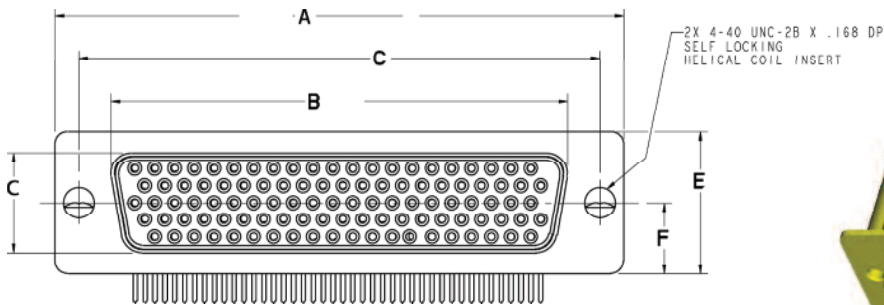

Receptacle - Socket

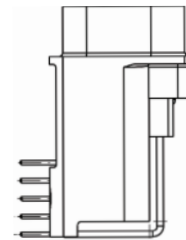
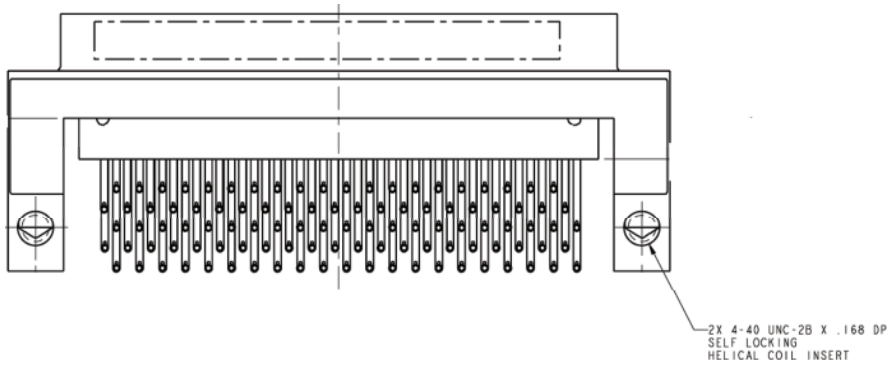

All K134 Connectors mate with standard ITT space D-Subminiature connectors built to NASA/GSFC/ESA dimensions.

Dimensions

Shell Size	Contacts	A	B	C	D	E
E	15	30,73 (1.21)	24,89 (0.98)	12,45 (0.49)	13,46 (0.53)	18,80 (0.74)
A	26	39,12 (1.54)	33,27 (1.31)	12,45 (0.49)	13,46 (0.53)	18,80 (0.74)
B	44	55,63 (2.09)	46,99 (1.85)	12,45 (0.49)	13,46 (0.53)	18,80 (0.74)
C	62	69,34 (2.73)	63,50 (2.50)	12,45 (0.49)	13,46 (0.53)	18,80 (0.74)
D	78	67,10 (2.64)	61,21 (2.41)	15,49 (0.61)	14,48 (0.57)	20,07 (0.79)
F	104	69,34 (2.73)	63,50 (2.50)	15,49 (0.61)	14,48 (0.57)	20,07 (0.79)



Dimensions shown in mm
Specifications and dimensions subject to
www.ittcannon.com

Pin

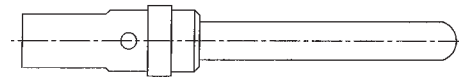

Contact Size	Wire Size AWG	Pin Part Number
20	20, 22, 24	330-5291-037
20-18	1 #18, 1 #20, or 2 #22	330-5291-055
20-26	26, 28, 30	330-5291-050
22D	22, 24, 26, 28	030-2042-002

Socket

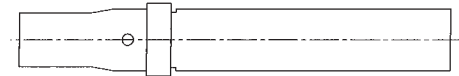

Contact Size	Wire Size AWG	Pin Part Number
20	20, 22, 24	031-1007-052
20-18	1 #18, 1 #20 or, 2 #22	031-1007-054
20-26	26, 28, 30	031-1007-048
22D	22, 24, 26, 28	031-1147-002

Insertion/Extraction Tools

CIET-20HD

Contact Size	Wire Size AWG	Plastic Insertion/Extraction		Plastic Extraction	
		Part Number	Description	Part Number	Description
20	20, 22, 24	980-2000-426	CIET-20HD	323-7010-000	CET-20-11
20-18	26, 28, 30	980-2000-426	CIET-20HD	323-7010-000	CET-20-11
20-18	1 #18	-	-	274-5016-002	CET-20-11
	2 #22	-	-	274-5016-002	CET-20-11
22D	22, 24, 26, 28	274-7048-000	CIET-22D	-	-
High Power	12,16	274-7003-000	CIET-12	-	-

Hand Crimp Tools

M22520/2-01

Contact Size	Wire Size AWG	Plastic Insertion/Extraction		Plastic Extraction	
		Part Number	Description	Part Number	Description
20	20, 22, 24	995-0001-584	M22520/2-01	995-0001-604	M22520/2-08
		995-0001-585	M22520/1-01	995-0001-244	TH25
2026	26, 28, 30	995-0001-585	M22520/1-01	995-0001-244	L3198-20HD
2018	1 #18				
	2 #22	995-0001-584	M22520-01	980-0005-722	K250
22D	22, 24, 26, 28	031-1147-002	M22520/2-01	995-0001-739	M22520/2-06

CBT-646 Vibra-Bowl Crimper

CBT-646

THE CBT-646, Vibra-Bowl Crimper is a pneumatically powered, electronically controlled machined. It is designed to semi-automatically crimp closed barrel, machined contacts, as used in the aerospace and commercial industries. The machine will accommodate wire sizes 30 thru 12 AWG. The CBT-646 is actuated automatically upon insertion of a pre-stripped stranded or single conductor wire.

Machine Crimp Rate: 1300+ per hour

Power Requirements: Electrical = 115 VAC, 60 Hz, 5A

Pneumatic = 85 psi, 2 cupid feet per minute

Dimensions shown in mm
Specifications and dimensions subject to

www.ittcannon.com



Loose Contacts Size 8 – Coaxial 50 Ohm, Straight

Straight Crimp Braid

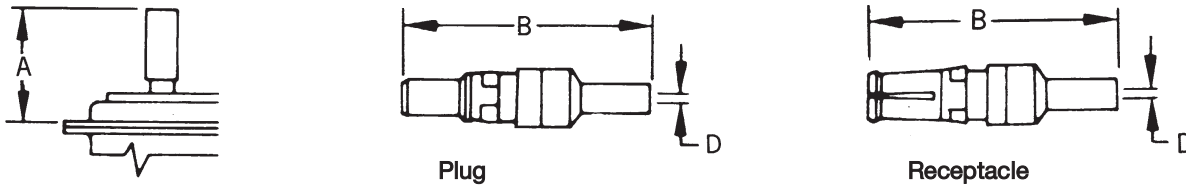

Note: Dimensions include outer sleeve.

	Part Number (50 μ m) 1,27 μ m Gold over Copper	A max	B max	D min	RG Cable Number	
					old	new
Plug	DM53740-17	18,80 (.74)	24,00 (.94)	1,00 (.039)	196/U	178B/U
Plug	DM53740-15	18,80 (.74)	24,00 (.94)	1,70 (.067)	187/U	179B/U
					188/U	316B/U
Plug	DM53740-44	18,80 (.74)	24,00 (.94)	1,70 (.067)	-	316B/U
Plug	DM53740-16	21,50 (.847)	26,34 (1.037)	2,79 (.110)	195/U	180B/U
Plug	DM53740-18	21,50 (.847)	26,34 (1.037)	3,18 (.125)	58/U	58B/U
Receptacle	DM53742-18	18,80 (.74)	24,00 (.94)	1,00 (.039)	196/U	178B/U
Receptacle	DM53742-16	18,80 (.74)	24,00 (.94)	1,70 (.067)	187/U	179B/U
					88/U	316B/U
Receptacle	DM53740-41	18,80 (.74)	24,00 (.94)	1,70 (.067)	-	316B/U
Receptacle	DM53742-19	21,50 (.847)	26,34 (1.037)	3,18 (.125)	58/U	58B/U

For Crimp tooling, see page 37.

Straight Solder Braid

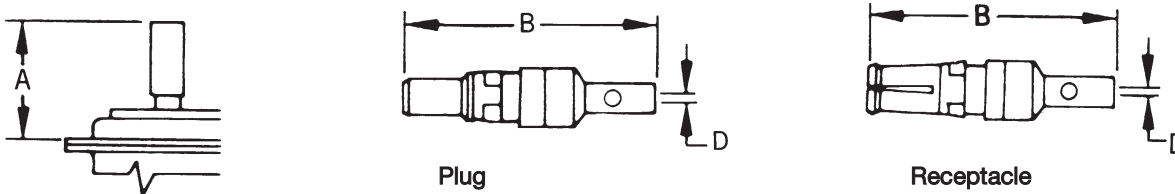

	Part Number 1,27 μ m Gold over Copper	A max	B max	D min	RG Cable Number	
					old	new
Plug	DM53740-5105	18,80 (.74)	24,00 (.94)	1,00 (.039)	196/U	178B/U
Plug	DM53740-5099	18,80 (.74)	24,00 (.94)	1,70 (.067)	187/U	179B/U
					188/U	316B/U
Plug	DM53740-5150	18,80 (.74)	24,00 (.94)	1,70 (.067)	-	316B/U
Plug	DM53740-5104	21,50 (.847)	26,34 (1.037)	2,79 (.110)	195/U	180B/U
Plug	DM53740-5101	21,50 (.847)	26,34 (1.037)	3,18 (.125)	58/U	58B/U
Plug (Short)	DM53740-5100	17,00 (.670)	22,20 (.882)	1,14 (.045)	196/U	178B/U
Receptacle	DM53742-5092	18,80 (.74)	24,00 (.94)	1,00 (.039)	196/U	178B/U
Receptacle	DM53742-5086	18,80 (.74)	24,00 (.94)	1,70 (.067)	187/U	179B/U
					188/U	316B/U
Receptacle	DM53740-5130	18,80 (.74)	24,00 (.94)	1,70 (.067)	-	316B/U
Receptacle	DM53742-5091	21,50 (.847)	26,34 (1.037)	2,79 (.110)	195/U	180B/U
Receptacle	DM53742-5086	21,50 (.847)	26,34 (1.037)	3,18 (.125)	58/U	58B/U
Receptacle (Short)	DM53742-5085	17,00 (.670)	22,20 (.882)	1,14 (.045)	196/U	178B/U

Loose Contacts Size 8 – Coaxial 50 Ohm, 90°

90° Crimp Braid

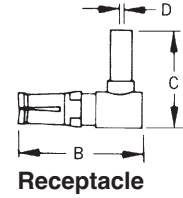
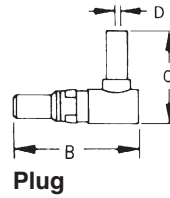
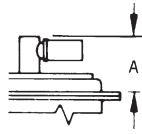

Note: Dimensions include outer sleeve.

	Part Number	A 50 μ in Gold over Copper	B max	C max	D ± 0,13	RG Cable Number	
						old	new
Plug	DM53741-12	13,46 (.530)	18,92 (.745)	15,10 (.594)	1,14 (.045)	196/U	178B/U
Plug	DM53741-11	13,46 (.530)	18,92 (.745)	15,10 (.594)	1,83 (.072)	187/U	179B/U
						188/U	316B/U
Plug	DM53741-10	13,46 (.530)	18,92 (.745)	16,00 (.630)	2,79 (.110)		
Plug	DM53741-13	13,46 (.530)	18,92 (.745)	16,00 (.630)	3,18 (.125)	58/U	58B/U
Receptacle	DM53743-18	13,46 (.530)	18,92 (.745)	15,09 (.594)	1,14 (.045)	196/U	178B/U
Receptacle	DM53743-16	13,46 (.530)	18,92 (.745)	15,09 (.594)	1,83 (.072)	187/U	179B/U
						188/U	316B/U
Receptacle	DM53743-17	13,46 (.530)	18,92 (.745)	16,00 (.630)	2,79 (.110)		
Receptacle	DM53743-19	13,46 (.530)	18,92 (.745)	16,00 (.630)	3,18 (.125)	58/U	58B/U

For Crimp tooling, see page 37.

90° Solder Braid

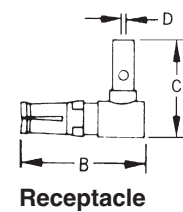
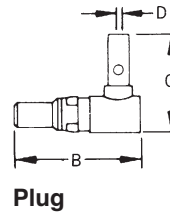
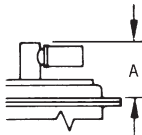

	Part Number	A 50 μ in Gold over Copper	B max	C max	D ± 0,13	RG Cable Number	
						old	new
Plug	DM53741-5059	13,46 (.530)	18,92 (.745)	15,10 (.594)	1,00 (.039)	196/U	178B/U
Plug	DM53741-5062	13,46 (.530)	18,92 (.745)	15,10 (.594)	1,70 (.067)	187/U	179B/U
						188/U	316B/U
Plug	DM53741-5063	13,46 (.530)	18,92 (.745)	16,00 (.630)	2,79 (.110)		
Plug	DM53741-5060	13,46 (.530)	18,92 (.745)	16,00 (.630)	3,18 (.125)	58/U	58B/U
Receptacle	DM53743-5073	13,46 (.530)	18,92 (.745)	15,09 (.594)	1,00 (.039)	196/U	178B/U
Receptacle	DM53743-5076	13,46 (.530)	18,92 (.745)	15,09 (.594)	1,70 (.067)	187/U	179B/U
						188/U	316B/U
Receptacle	DM53743-5077	13,46 (.530)	18,92 (.745)	16,00 (.630)	2,79 (.110)		
Receptacle	DM53743-5074	13,46 (.530)	18,92 (.745)	16,00 (.630)	3,18 (.125)	58/U	58B/U

Dimensions shown in mm
Specifications and dimensions subject to

www.ittcannon.com



Insertion / Extraction Instructions for Coaxial, High Power and High Voltage Contacts

Insertion Tool

Insertion Instructions

No insertion tool is required. The contact is easily snapped in from the rear of the connector manually.

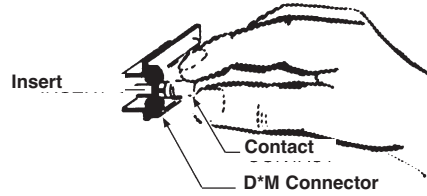

Extraction Tool

Operating Instructions

CET-C6B-2

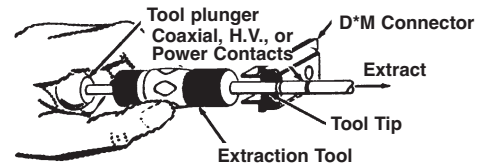

The CET-C6B-2 tool extracts all coaxial, high power and high voltage contacts (plug and receptacle).

To extract the coaxial contact, hold the tool by the body and insert the tip into the front of the contact cavity until it bottoms and closes the coaxial retaining ring. Holding the body in this position securely enough to keep coaxial retaining ring closed, push the plunger; contact will be pushed out of the rear of the assembly.

Description	Part Number
CET-C6B-2	070064-0002



Coaxial Assembly Instructions

Straight and 90° Coaxial Assembly Step 1:

Slide the outer ring over the cable jacket. Trim the cable as specified in the table of Coaxial Cable Trim Dimensions (see this page). Insert the cable dielectric and center conductor into the inside diameter of the inner sleeve. Then solder the center conductor to the coaxial center contact.

Straight Coaxial

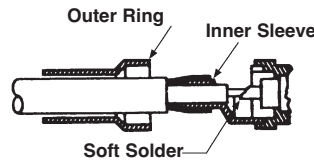

90° Coaxial

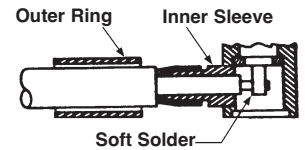

Straight and 90° Coaxial Assembly Step 2:

Slide the outer ring forward until it is flush with the coaxial shell containing the braid between the outer ring and the inner sleeve. For solder type coaxes, soft solder the outer ring to the assembly through the cross-drilled solder hold. For crimp type coaxes, crimp with the appropriate tool in the area defined.

Straight Coaxial

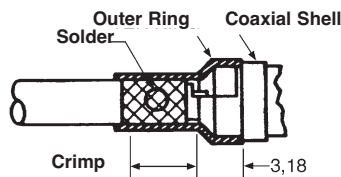

90° Coaxial

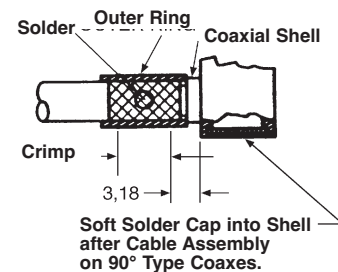

Coaxial Cable Trim Dimensions

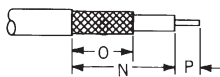

Straight Coaxial RG Cable Number	N	O	P
196/U, 178B/U, 187/U, 188/U, 179B/U, 316B/U	7,92 (.312)	6,35 (.250)	1,98 (.078)
58/U, 58B/U	9,52 (.375)	7,92 (.312)	1,98 (.078)

90° Coaxial RG Cable Number	N	O	P
196/U, 178B/U, 187/U, 188/U, 179B/U, 316B/U	9,52	5,94	1,57
58/U, 58B/U	10,69	7,92	2,39

Crimp Tooling



RG Cable Number	Tool Part Number	Description	Closure
196/U, 178B/U	070051-0000	CCT-DM	C
187/U, 179B/U, 188/U, 316B/U	070051-0000	CCT-DM	B
58/U, 58B/U	070051-0000	CCT-DM	A

Hand Tool with integral die set for all coaxial straight crimp braid.

Dimensions shown in mm
Specifications and dimensions subject to

www.ittcannon.com



Cable (Size 8) Loose Contacts — High Voltage — Straight

Plug

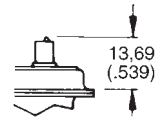
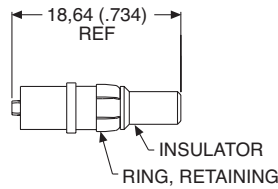

Part Number	Wire
50 μ in. Gold	Size
DM51157-8	20 AWG

Receptacle

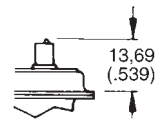
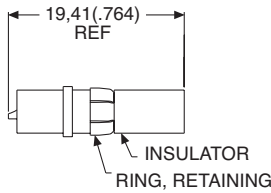

Part Number	Wire
50 μ in. Gold	Size
DM51155-7	20 AWG

Cable (Size 8) Loose Contacts — High Voltage — 90°

Plug

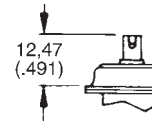
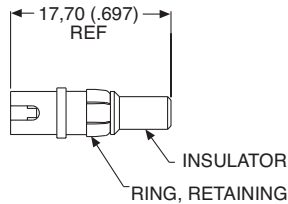

Part Number	Wire
50 μ in. Gold	Size
DM51157-5005	20 AWG

Receptacle

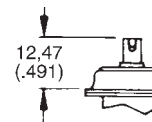
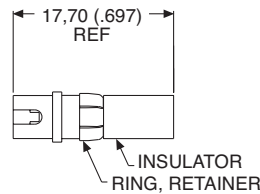

Part Number	Wire
50 μ in. Gold	Size
DM51155-5004	20 AWG

Loose Contacts, Size 8 – High Power – Solder – Non-Magnetic

Plug

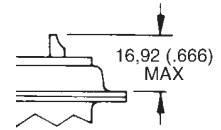
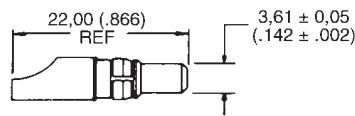

Part Number 50µ in. Gold Over Copper Non-Magnetic	Part Number 50µ in. Gold Over Copper Non-Magnetic (European)	Current Rating	Wire Size
DM53745-72	DM115224-1040A	40 A	8 AWG
DM53745-77	DM115224-1020A	20 A	12 AWG
DM53745-70	DM115224-1010A	10 A	16 AWG

Receptacle

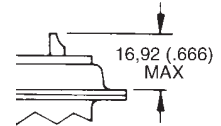
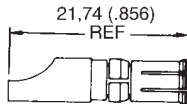

Part Number 50µ in. Gold Over Copper Non-Magnetic	Part Number 50µ in. Gold Over Copper Non-Magnetic (European)	Current Rating	Wire Size
DM53744-62	DM115224-2040A	40 A	8 AWG
DM53744-64	DM115224-2020A	20 A	12 AWG
DM53744-63	DM115224-2010A	10 A	16 AWG

Loose Contacts, Size 8 – High Power – Crimp – Non-Magnetic

Plug

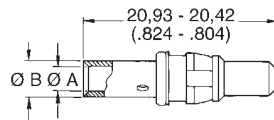

Recommended Wire Trim Length

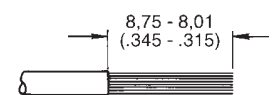

Part Number 50µ in. Gold Over Copper Non-Magnetic	XA max.	XB max.	Part Number 50µ in. Gold Over Copper Non-Magnetic (European)	XA min.	XB max.	Current Rating	Wire Size
DM115224-3040	4,60 (.181)	5,84 (.230)	DM115224-3040A	4,20 (.165)	5,80 (.228)	40 A	8 AWG
DM115224-3020	2,54 (.100)	5,54 (.218)	DM115224-3020A	3,25 (.128)	4,70 (.185)	20 A	12 AWG
DM115224-3010	1,07 (.067)	2,59 (.102)	DM115224-3010A	2,50 (.098)	3,80 (.150)	10 A	16 AWG

Receptacle

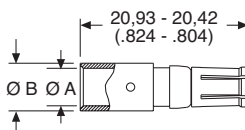

Recommended Wire Trim Length

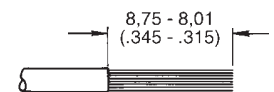

Part Number 50µ in. Gold Over Copper Non-Magnetic	XA max.	XB max.	Part Number 50µ in. Gold Over Copper Non-Magnetic (European)	XA min.	XB max.	Current Rating	Wire Size
DM115224-4040	4,60 (.181)	5,84 (.230)	DM115224-4040A	4,20 (.165)	5,80 (.228)	40 A	8 AWG
DM115224-4020	2,54 (.100)	5,54 (.218)	DM115224-4020A	3,25 (.128)	4,70 (.185)	20 A	12 AWG
DM115224-4010	1,07 (.067)	2,59 (.102)	DM115224-4010A	2,50 (.098)	3,80 (.150)	10 A	16 AWG

Crimp High Power Tooling

M300-BT



Wire Size	Crimp Tool	Crimp Tool/Locator		Locator
		Tool Setting Number Standard Contacts	Tool Setting Number European Contacts	
8 AWG	M300-BT	6	6	TP968
10 AWG	M300-BT	5	2	TP968
12 AWG	M300-BT	1	1	TP968

Dimensions shown in mm
Specifications and dimensions subject to
www.ittcannon.com



Metal Backshells provide strain relief. Various profiles available for different cable routing requirements.

Materials and Finishes

Material	Brass
Finish	50µ in. Gold over Copper

Packaging unit : 1 piece (plastic bag)
Residual Magnetism level NMB (200 Gamma max)

Product Features

- Qualified to MIL-Spec M85049

Deep Straight Clamp

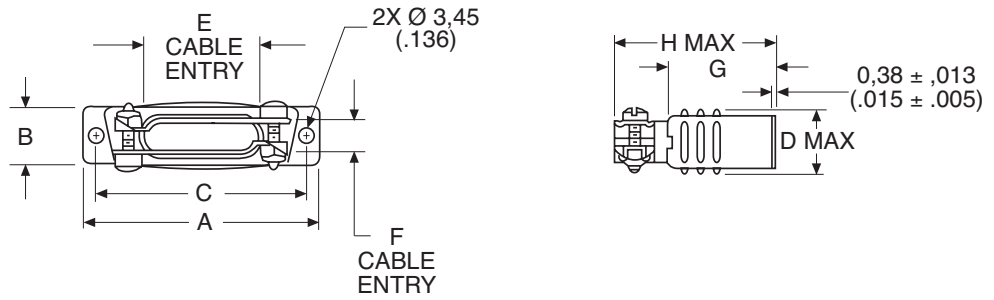

- Kit consists of 1 shell, 2 cable clamps, 2 screws, 2 hex nuts.

Shell Size	Layout	Part Number Non-Magnetic	A ±0,38 (.015)	B ±0,572 (.0225)	C ±0,13 (.005)	D max	E ±0,38 (.015)	F ±0,38 (.015)	G ±0,38 (.015)	H max
DE	9	DE24657-16	30,56 (1.203)	12,484 (.4915)	24,99 (.984)	14,68 (.578)	9,53 (.375)	9,53 (.375)	19,05 (.750)	31,75 (1.250)
DA	15	DA24658-15	38,88 (1.531)	12,484 (.4915)	33,32 (1.312)	14,68 (.578)	18,11 (.713)	7,93 (.312)	19,05 (.750)	31,75 (1.250)
DB	25	DB24659-15	52,78 (2.078)	12,484 (.4915)	47,04 (1.852)	14,68 (.578)	25,40 (1.000)	7,93 (.312)	25,40 (1.000)	39,70 (1.563)
DC	37	DC24660-16	69,04 (2.718)	12,484 (.4915)	63,50 (2.500)	14,68 (.578)	34,93 (1.375)	7,93 (.312)	25,40 (1.000)	39,70 (1.563)
DD	50	DD24661-13	66,68 (2.625)	15,253 (.6005)	61,11 (2.406)	17,45 (.687)	35,71 (1.406)	10,31 (.406)	28,57 (1.125)	42,88 (1.688)

Round Cable Clamp

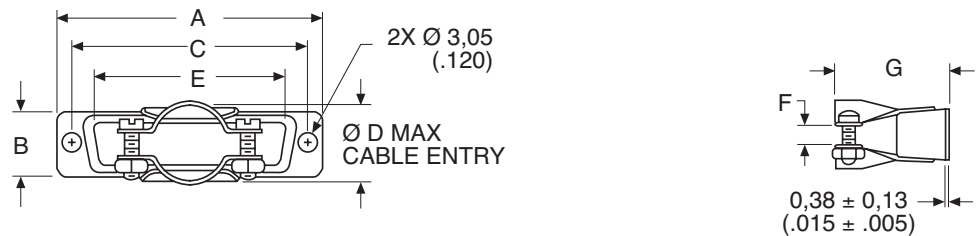

- Kit consists of 1 shell, 2 screws, 2 hex nuts.

Shell Size	Layout	Part Number Non-Magnetic	A ±0,38 (.015)	B ±0,38 (.015)	C ±0,13 (.005)	D max	E ±0,38 (.015)	F ±0,38 (.015)	G ±0,38 (.015)
DE	9	DE44994-2	30,68 (1.208)	12,70 (.500)	24,99 (.984)	10,31 (.406)	16,79 (.661)	3,18 (.125)	26,18 (1.031)
DA	15	DA20961-16	38,89 (1.531)	12,70 (.500)	33,32 (1.312)	10,31 (.406)	24,99 (.984)	3,18 (.125)	26,18 (1.031)
DB	25	DB20962-18	52,78 (2.078)	12,70 (.500)	47,04 (1.852)	15,06 (.593)	38,48 (1.515)	4,75 (.187)	26,98 (1.062)
DC	37	DC20963-17	69,04 (2.718)	12,70 (.500)	63,50 (2.500)	18,23 (.718)	55,14 (2.171)	6,35 (.250)	26,98 (1.062)
DD	50	DD20964-19	66,68 (2.625)	12,70 (.500)	61,11 (2.406)	20,62 (.812)	53,16 (2.093)	7,92 (.312)	26,98 (1.062)



Short Straight Clamp

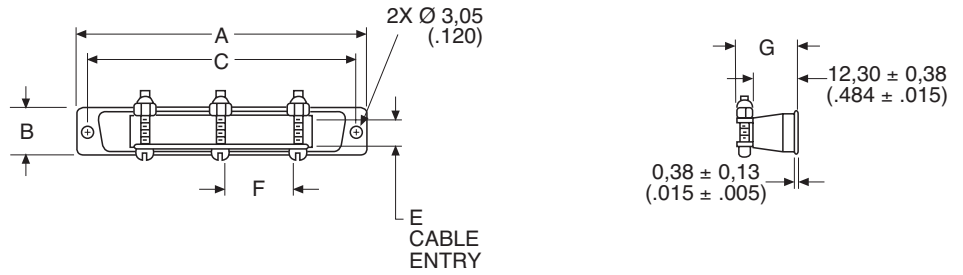

- Kit consists of 1 shell, 2 or 3 screws, 2 or 3 hex nuts.

Shell Size	Layout	Part Number Non-Magnetic	No. of Cable Locking Screws Included	A	B	C	E	F	G
				±0,38 (.015)	±0,38 (.015)	±0,13 (.005)	±0,38 (.015)	±0,38 (.015)	±0,89 (.035)
DA	15	DA19678-167	2	38,88 (1.531)	12,70 (.500)	14,68 (.578)	7,51 (.296)	7,93 (.312)	16,36 (.644)
DB	25	DB19678-168	2	52,78 (2.078)	12,70 (.500)	14,68 (.578)	7,51 (.296)	20,22 (.796)	16,36 (.644)
DC	37	DC19678-138	3	69,04 (2.718)	12,70 (.500)	14,68 (.578)	7,51 (.296)	17,45 (.687)	16,36 (.644)
DD	50	DD19678-161	3	66,68 (2.625)	15,47 (.609)	17,45 (.687)	9,91 (.390)	17,45 (.687)	17,63 (.694)

90° Entry

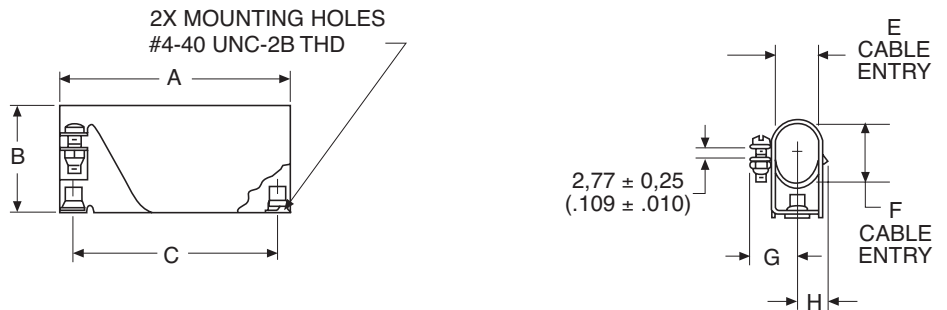

- Kit consists of 1 shell, 1 cable clamp, 1 screw, 1 nut, 2 rivnuts (assembled)

Shell Size	Layout	Part Number Non-Magnetic	A	B	C	E	F	G	H
			±0,38 (.015)	±0,76 (.030)	±0,13 (.005)	±0,76 (.030)	±0,76 (.030)	±0,76 (.030)	±0,76 (.030)
DE	9	DE19977-47	30,56 (1.203)	18,24 (.714)	24,99 (.984)	11,10 (.437)	11,10 (.437)	11,89 (.468)	7,14 (.281)
DA	15	DA19977-40	38,89 (1.531)	18,24 (.714)	33,33 (1.312)	11,10 (.437)	11,10 (.437)	11,89 (.468)	7,14 (.281)
DB	25	DB19977-43	52,78 (2.078)	24,58 (.968)	47,04 (1.852)	11,10 (.437)	15,88 (.625)	11,89 (.468)	7,14 (.281)
DC	37	DC19977-45	69,04 (2.718)	30,15 (1.187)	63,50 (2.500)	11,10 (.437)	20,63 (.812)	11,89 (.468)	7,14 (.281)
DD	50	DD19977-44	66,68 (2.625)	31,75 (1.250)	61,11 (2.406)	14,28 (.562)	23,01 (.906)	13,49 (.531)	8,71 (.343)

ITT Cannon offers the largest variety of locking and latching hardware.

Product Features

- Ensures positive mating
- Provides locking and latching for high vibration applications

Residual magnetism level

- Brass parts : NMB (200 Gamma max)

Front Panel Mount

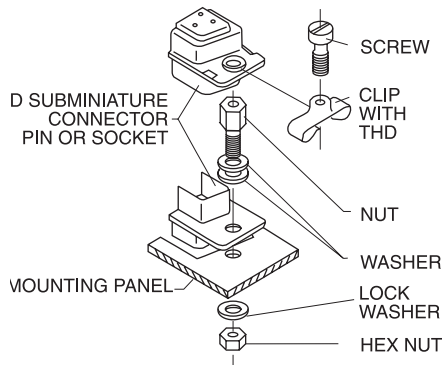

Rear Panel Mount

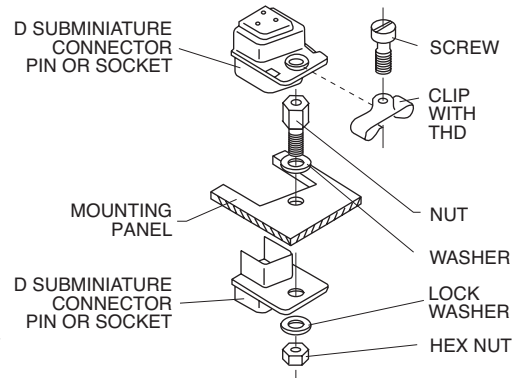

Female Screw Lock

- Kit consists of 1 nut, 3 washers, 1 lock washer, 1 hex nut
- Order 2 per connector



Front Panel Mount

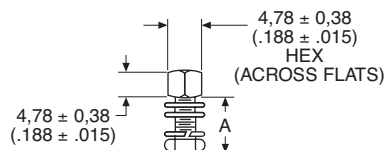

Rear Panel Mount

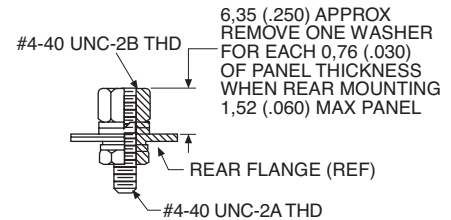

Note:

- (1) A 6 inch/pound (female) and 4 inch/pound (male) maximum torque during assembly is recommended on steel screw lock assemblies.
- (2) A third flat washer is supplied for panel mounting of tab shell connectors.

100 μin Au	50 μin Au	Stainless Steel	A ±0,38 (.015)
D20418-52	D20418-139	D20418-14	7,92 (.312)
D20418-73	D20418-141	D20418-102	12,70 (.500)
D20418-126	D20418-142	D20418-77	15,88 (.625)

Male Screw Lock

- Kit consists of 1 screw and 1 clip
- Order 2 per connector

Materials and Finishes

Material:	Copper Alloy
Finish:	Gold over Copper

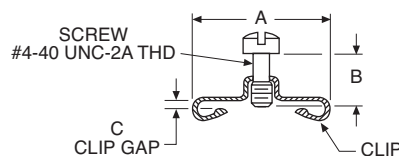

100 μin Au	50 μin Au*	Stainless Steel	A ±0,38 (.015)	B ±0,25 (.010)	C ±0,13 (.005)	For Shell Size
D20419-74	D20419-223	D20419-14	14,10 (.555)	6,35 (.250)	1,22 (.048)	DE,DA,DB,DC
D20419-48	-	D20419-28	14,10 (.555)	7,14 (.281)	1,22 (.048)	DE,DA,DB,DC
D20419-73	D20419-225	D20419-38	14,10 (.555)	7,14 (.281)	1,70 (.067)	DE,DA,DB,DC
D20419-84	D20419-224	-	14,10 (.555)	7,14 (.281)	2,34 (.092)	DE,DA,DB,DC
D20420-67	D20420-171	D20420-21	16,66 (.656)	6,35 (.250)	1,22 (.048)	DD
D20420-49	D20420-170	D20420-136	16,66 (.656)	7,14 (.281)	1,70 (.067)	DD
D20420-63	D20420-172	D20420-70	16,66 (.656)	7,14 (.281)	2,34 (.092)	DD
D20420-88	-	-	16,66 (.656)	7,92 (.312)	2,34 (.092)	DD

* Kit consists of two screws and two

Dimensions shown in mm
Specifications and dimensions subject to

www.ittcannon.com



NASA/GSFC Cross Reference

NASA/GSFC Part Number	ITT Cannon Part Number	NASA/GSFC Part Number	ITT Cannon Part Number	NASA/GSFC Part Number	ITT Cannon Part Number
GO8P1 GO8S1 S-311-P-4/6GCP1 S-311-P-4/6GCP2 S-311-P-4/6GCP3	030-2042-002 031-1147-002 DM53740-17 DM53740-15 DM53740-16	311-P-10-12S-B-15 311-P-10-13P-B-12 311-P-10-13P-B-15	DBM13W3S-NMB-76 DBM17W2PNMB77 DBM-17W2P-NMB-76	311-P-10-24P-B-12	DDM43W2P-NMB-77
S-311-P-4/6GCP4 S-311-P-4/6GCRP1 S-311-P-4/6GCRP2 S-311-P-4/6GCRP3 S-311-P-4/6GCRP4	DM53740-18 DM53741-12 DM53741-11 DM53741-10 DM53741-13	311-P-10-13S-B-12 311-P-10-14P-B-12	DBM17W2SNMB77 DBM-21W1P-NMB-77	311-P-10-3S-B-12 311-P-10-3P-B-15	DBM25PNMB77 DBM25PNMB76
S-311-P-4/6GCRS1 S-311-P-4/6GCRS2 S-311-P-4/6GCRS3 S-311-P-4/6GCRS4 S-311-P-4/6GCS1	DM53743-18 DM53743-16 DM53743-17 DM53743-19 DM53742-18	311-P-10-14P-B-15 311-P-10-14S-B-12 311-P-10-14S-B-15	DBM-21W1P-NMB-76 DBM-21W1S-NMB-77 DBM-21W1S-NMB-76	311-P-10-3S-B-15	DBM-25S-NMB-76
S-311-P-4/6GCS2 S-311-P-4/6GCS3 S-311-P-4/6GCS4 S-311-P-4/6GHP6 S-311-P-4/6GHRP6	DM53742-16 DM53742-17 DM53742-19 DM51157-8 DM51157-5005	311-P-10-15P-B-12 311-P-10-15P-B-15	DCM-8W8P-NMB-77 DCM8W8PNMB76	311-P-10-4P-B-12 311-P-10-4P-B-15	DCM37PNMB77 DCM37PNMB76
S-311-P-4/6GHRP6 S-311-P-4/6GHRP6 S-311-P-4/6GHRP6 311P409-1P-B-12 311P409-1P-B-15 311P409-1S-B-12	DM51155-5005 DM51155-7 DEMA9PNMBK47FO DEMAK9PNMBK47FO DEMA9SNMBK47FO	311-P-10-16P-B-12 311-P-10-16P-B-15	DCM-13W6P-NMB-77 DCM-13W6P-NMB-76	311-P-10-5P-B-12 311-P-10-5P-B-15	DDM50PNMB77 DDM50PNMB76
311P409-1S-B-15 311P409-2P-B-12 311P409-2P-B-15 311P409-2S-B-12 311P409-2S-B-15	DEMAK9SNMBK47FO DEMA15PNMBK47FO DEMAK15PNMBK47FO DEMA15SNMBK47FO DEMAK15SNMBK47FO	311-P-10-16S-B-12	DCM-13W6S-NMB-77	311-P-10-5S-B-12 311-P-10-5S-B-15	DDM50SNMB77 DDM50SNMB76
311P409-3P-B-12 311P409-3P-B-15 311P409-3S-B-12 311P409-3S-B-15 311P409-4P-B-12	DEMA25PNMBK47FO DEMAK25PNMBK47FO DEMA25SNMBK47FO DEMAK25SNMBK47FO DEMA37PNMBK47FO	311-P-10-17P-B-12	DCM17W5PNMB77	311-P-10-6P-B-12	DEM-5W1P-NMB-77
311P409-3P-B-12 311P409-3P-B-15 311P409-3S-B-12 311P409-3S-B-15 311P409-4P-B-12	DEMA25PNMBK47FO DEMAK25PNMBK47FO DEMA25SNMBK47FO DEMAK25SNMBK47FO DEMA37PNMBK47FO	311-P-10-17P-B-15	DCM-17W5P-NMB-76	311-P-10-6P-B-15	DEM-5W1P-NMB-76
311P409-4P-B-15 311P409-4S-B-12 311P409-4S-B-15 311P409-5P-B-12 311P409-5S-B-15	DEMAK37PNMBK47FO DEMA37SNMBK47FO DEMAK37SNMBK47FO DEMA50PNMBK47FO DEMAK50PNMBK47FO	311-P-10-17S-B-12 311-P-10-17S-B-15	DCM-17W5S-NMB-77 DCM17W5S-NMB-76	311-P-10-6P-B-12	DEM-5W1S-NMB-77
311P409-4P-B-15 311P409-4S-B-12 311P409-4S-B-15 311P409-5P-B-12 311P409-5S-B-15	DEMAK37PNMBK47FO DEMA37SNMBK47FO DEMAK37SNMBK47FO DEMA50PNMBK47FO DEMAK50PNMBK47FO	311-P-10-18P-B-12 311-P-10-18P-B-12	DCM-21WA4P-NMB-77 DCM21WA4P-NMB-76	311-P-10-7P-B-12 311-P-10-7P-B-15	DAM3W3PNMB77 DAM3W3PNMB76
311P409-5S-B-12 311P409-5S-B-15 S-311-P-4/10G1OP1 S-311-P-4/10G1OS1 311-P-10-B-1S-B-15	DEMA50SNMBK47FO DEMAK50PNMBK47FO 330-5291-081-02 031-1007-052-05 DEMB9S-NMB-76	311-P-10-18S-B-12 311-P-10-18S-B-15 311-P-10-19P-B-12 311-P-10-19S-B-12	DCM-21WA4S-NMB-77 DCM21WA4S-NMB-76 DCM-21W4P-NMB-77 DCM-21W4S-NMB-77	311-P-10-7P-B-15	DAM3W3SNMB77 DAM3W3SNMB76
311-P-10-B-4S-B-15 311-P-10-1P-B-12 311-P-10-1P-B-15	DCMB37S-NMB-76 DEMPPNMB77 DEM-9P-NMB-76	311-P-10-2P-B-12 311-P-10-2P-B-15	DAM15PNMB77 DAM15PNMB76	311-P-10-8P-B-12 311-P-10-8P-B-15	DAM-7W2P-NMB-77 DAM-7W2P-NMB-76
311-P-10-1S-B-12 311-P-10-1S-B-15	DEM9SNMB77 DEM-9S-NMB-76	311-P-10-2S-B-12 311-P-10-2S-B-15	DAM15SNMB77 DAM-15S-NMB-76	311-P-10-9P-B-12 311-P-10-9P-B-15	DAM-11W1P-NMB-77 DAM-11W1P-NMB-76
311-P-10-10P-B-12 311-P-10-10P-B-15	DBM5W5PNMB77 DBM-5W5P-NMB-76	311-P-10-20P-B-12	DCM-25W3P-NMB-77	311-P-10-9S-B-12 311-P-10-9S-B-15	DAM-11W1S-NMB-77 DAM-11W1S-NMB-76
311-P-10-10S-B-12 311-P-10-10S-B-15	DBM-5W5S-NMB-77 DBM-5W5S-NMB-76	311-P-10-20S-B-12	DCM-25W36-NMB-77	311-P-10B-1S-B-12	DEMB9SNMB77
311-P-10-11P-B-12 311-P-10-11S-B-12	DBM-9W4P-NMB-77 DBM-9W4S-NMB-77	311-P-10-22P-B-12 311-P-10-22P-B-15 311-P-10-22S-B-12 311-P-10-22S-B-15	DDM-24W7P-NMB-77 DDM24W7PNMB76 DDM24W7SNMB77 DDM-24W7S-NMB-76	311-P-10-8S-B-12	DAM-7W2S-NMB-77
311-P-10-12P-B-12 311-P-10-12P-B-15	DBM13W3P-NMB-77 DBM-13W3P-NMB-76	311-P-10-23P-B-12 311-P-10-23S-B-12 311-P-10-23S-B-15	DDM-36W4P-NMB-77 DDM-36W4S-NMB-77 DDM36W4SNMB76	311-P-10-9P-B-12 311-P-10-9P-B-15	DAM-11W1P-NMB-77 DAM-11W1P-NMB-76
311-P-10-12S-B-12	DBM-13W3S-NMB-77			311-P-10B-13S-B-15	DBMB-17W2S-NMB-76
				311-P-10B-17S-B-15 311-P-10B-2S-B-12	DCMB-17W5S-NMB-76 DAMB15SNMB77
				311-P-10B-22S-B-15	DDMB-247S-NMB-76
				311-P-10B-3S-B-12 311-P-10B-3S-B-15	DBMB-25S-NMB-77 DBMB-25S-NMB-76
				311-P-10B-4S-B-12	DCMB-37S-NMB-77

Dimensions shown in mm
 Specifications and dimensions subject to
www.ittcannon.com



NASA/GSFC Cross Reference

NASA/GSFC Part Number	ITT Cannon Part Number	NASA/GSFC Part Number	ITT Cannon Part Number	NASA/GSFC Part Number	ITT Cannon Part Number
311-P-10B-5S-B-12 311-P-10B-5S-B-15	DDMB-50S-NMB-77 DDMB50S-NMB-76	311-P-10B-6S-B-15 311-P-10B-8S-B-12	DEMB-5W1S-NMB-76 DAMB-7W2S-NMB-77	311-P-10B-8S-B-15 311-P-10B-9S-B-12	DAMB-7W2S-NMB-76 DAMB-11W1S-NMB-77

ESA/SCC Cross Reference

ESA-SCC Part Number	ITT Cannon Part Number	ESA-SCC Part Number	ITT Cannon Part Number	ESA-SCC Part Number	ITT Cannon Part Number
340100101B DEM5W1SNMB 340100101B DAM3W3SNMB 340100101B DAM7W2SNMB 340100101B DAM11W1SNMB 340100101B DBM5W5SNMB	DEM5W1SNMBK52 DAM3W3SNMBK52 DAM7W2SNMBK52 DAM11W1SNMBK52 DBM5W5SNMBK52	340100101B DBM17W2POL3NMB 340100101B DBM21W1POL3NMB 340100101B DCM13W6POL3NMB 340100101B DCM17W5POL3NMB 340100101B DCM21WA4POL3NMB	DBM17W2POL3NMBK52 DBM21W1POL3NMBK52 DCM13W6POL3NMBK52 DCM17W5POL3NMBK52 DCM21WA4POL3NMBK52	340100101B DAM7W2P1A7NNMB 340100101B DAM11W1P1A7NNMB 340100101B DBM9W4P1A7NNMB 340100101B DBM13W3P1A7NNMB 340100101B DBM17W2P1A7NNMB	DAM7W2P1A7NNMBK52 DAM11W1P1A7NNMBK52 DBM9W4P1A7NNMBK52 DBM13W3P1A7NNMBK52 DBM17W2P1A7NNMBK52
340100101B DBM9W4SNMB 340100101B DBM13W3SNMB 340100101B DBM17W2SNMB 340100101B DBM21W1SNMB 340100101B DCM8W8SNMB	DBM9W4SNMBK52 DBM13W3SNMBK52 DBM17W2SNMBK52 DBM21W1SNMBK52 DCM8W8SNMBK52	340100101B DCM25W3POL3NMB 340100101B DCM27W2POL3NMB 340100101B DDM24W7POL3NMB 340100101B DDM36W4POL3NMB 340100101B DDM43W2POL3NMB	DCM25W3POL3NMBK52 DCM27W2POL3NMBK52 DDM24W7POL3NMBK52 DDM36W4POL3NMBK52 DDM43W2POL3NMBK52	340100101B DBM21W1P1A7NNMB 340100101B DCM13W6P1A7NNMB 340100101B DCM17W5P1A7NNMB 340100101B DCM21WA4P1A7NNMB 340100101B DCM25W3P1A7NNMB	DBM21W1P1A7NNMBK52 DCM13W6P1A7NNMBK52 DCM17W5P1A7NNMBK52 DCM21WA4P1A7NNMBK52 DCM25W3P1A7NNMBK52
340100101B DCM13W6SNMB 340100101B DCM17W5SNMB 340100101B DCM21WA4SNMB 340100101B DCM25W3SNMB 340100101B DCM27W2SNMB	DCM13W6SNMBK52 DCM17W5SNMBK52 DCM21WA4SNMBK52 DCM25W3SNMBK52 DCM27W2SNMBK52	340100101B DDM47W1POL3NMB 340100101B DEM5W1S1AONNMB 340100101B DAM7W2S1AONNMB 340100101B DAM11W1S1AONNMB 340100101B DBM9W4S1AONNMB	DDM47W1POL3NMBK52 DEM5W1S1AONNMBK52 DAM7W2S1AONNMBK52 DAM11W1S1AONNMBK52 DBM9W4S1AONNMBK52	340100101B DCM27W2P1A7NNMB 340100101B DDM24W7P1A7NNMB 340100101B DCM17W5P1A7NNMB 340100101B DCM21WA4P1A7NNMB 340100101B DCM25W3P1A7NNMB	DCM27W2P1A7NNMBK52 DDM24W7P1A7NNMBK52 DCM17W5P1A7NNMBK52 DCM21WA4P1A7NNMBK52 DCM25W3P1A7NNMBK52
340100101B DDM24W7SNMB 340100101B DDM36W4SNMB 340100101B DDM43W2SNMB 340100101B DDM47W1SNMB 340100101B DEM5W1PNMB	DDM24W7SNMBK52 DDM36W4SNMBK52 DDM43W2SNMBK52 DDM47W1SNMBK52 DEM5W1PNMBK52	340100101B DBM13W3S1AONNMB 340100101B DBM17W2S1AONNMB 340100101B DBM21W1S1AONNMB 340100101B DBM9W4S1AONNMB 340100101B DCM13W6S1AONNMB	DBM13W3S1AONNMBK52 DBM17W2S1AONNMBK52 DBM21W1S1AONNMBK52 DBM9W4S1AONNMBK52 DCM13W6S1AONNMBK52	340100101B DEM5W1S1A9NNMB 340100101B DAM7W2S1A9NNMB 340100101B DAM11W1S1A9NNMB 340100101B DBM9W4S1A9NNMB 340100101B DBM13W3S1A9NNMB	DEM5W1S1A9NNMBK52 DAM7W2S1A9NNMBK52 DAM11W1S1A9NNMBK52 DBM9W4S1A9NNMBK52 DBM13W3S1A9NNMBK52
340100101B DAM3W3PNMB 340100101B DAM7W2PNMB 340100101B DAM11W1PNMB 340100101B DBM5W5PNMB 340100101B DBM9W4PNMB	DAM3W3PNMBK52 DAM7W2PNMBK52 DAM11W1PNMBK52 DBM5W5PNMBK52 DBM9W4PNMBK52	340100101B DCM21WA4S1AONNMB 340100101B DCM25W3S1AONNMB 340100101B DCM27W2S1AONNMB 340100101B DDM24W7S1AONNMB 340100101B DDM36W4S1AONNMB	DCM21WA4S1AONNMBK52 DCM25W3S1AONNMBK52 DCM27W2S1AONNMBK52 DDM24W7S1AONNMBK52 DDM36W4S1AONNMBK52	340100101B DBM17W2S1A9NNMB 340100101B DBM21W1S1A9NNMB 340100101B DCM13W6S1A9NNMB 340100101B DCM17W5S1A9NNMB 340100101B DCM21WA4S1A9NNMB	DBM17W2S1A9NNMBK52 DBM21W1S1A9NNMBK52 DCM13W6S1A9NNMBK52 DCM17W5S1A9NNMBK52 DCM21WA4S1A9NNMBK52
340100101B DBM13W3PNMB 340100101B DBM17W2PNMB 340100101B DBM21W1PNMB 340100101B DCM8W8PNMB 340100101B DCM13W6PNMB	DBM13W3PNMBK52 DBM17W2PNMBK52 DBM21W1PNMBK52 DCM8W8PNMBK52 DCM13W6PNMBK52	340100101B DDM47W1S1AONNMB 340100101B DEM5W1P1AONNMB 340100101B DAM7W2P1AONNMB 340100101B DAM11W1P1AONNMB	DDM47W1S1AONNMBK52 DEM5W1P1AONNMBK52 DAM7W2P1AONNMBK52 DAM11W1P1AONNMBK52	340100101B DCM25W3S1A9NNMB 340100101B DCM27W2S1A9NNMB 340100101B DDM24W7S1A9NNMB 340100101B DDM36W4S1A9NNMB 340100101B DDM43W2S1A9NNMB	DCM25W3S1A9NNMBK52 DCM27W2S1A9NNMBK52 DDM24W7S1A9NNMBK52 DDM36W4S1A9NNMBK52 DDM43W2S1A9NNMBK52
340100101B DCM17W5PNMB 340100101B DCM21WA4PNMB 340100101B DCM25W3PNMB 340100101B DCM27W2PNMB 340100101B DDM24W7PNMB	DCM17W5PNMBK52 DCM21WA4PNMBK52 DCM25W3PNMBK52 DCM27W2PNMBK52 DDM24W7PNMBK52	340100101B DBM9W4P1AONNMB 340100101B DBM13W3P1AONNMB 340100101B DBM17W2P1AONNMB 340100101B DBM21W1P1AONNMB 340100101B DCM13W6P1AONNMB	DBM9W4P1AONNMBK52 DBM13W3P1AONNMBK52 DBM17W2P1AONNMBK52 DBM21W1P1AONNMBK52 DCM13W6P1AONNMBK52	340100101B DBM13W3P1A9NNMB 340100101B DBM17W2P1A9NNMB 340100101B DAM11W1P1A9NNMB 340100101B DBM9W4P1A9NNMB	DBM13W3P1A9NNMBK52 DBM17W2P1A9NNMBK52 DAM11W1P1A9NNMBK52 DBM9W4P1A9NNMBK52
340100101B DDM36W4PNMB 340100101B DDM43W2PNMB 340100101B DDM47W1PNMB 340100101B DEM5W1SOL3NMB 340100101B DAM7W2SOL3NMB	DDM36W4PNMBK52 DDM43W2PNMBK52 DDM47W1PNMBK52 DEM5W1SOL3NMBK52 DAM7W2SOL3NMBK52	340100101B DCM17W5P1AONNMB 340100101B DCM21WA4P1AONNMB 340100101B DCM25W3P1AONNMB 340100101B DCM27W2P1AONNMB 340100101B DDM24W7P1AONNMB	DCM17W5P1AONNMBK52 DCM21WA4P1AONNMBK52 DCM25W3P1AONNMBK52 DCM27W2P1AONNMBK52 DDM24W7P1AONNMBK52	340100101B DBM13W3P1A9NNMB 340100101B DBM17W2P1A9NNMB 340100101B DCM13W6P1A9NNMB 340100101B DCM17W5P1A9NNMB	DBM13W3P1A9NNMBK52 DBM17W2P1A9NNMBK52 DCM13W6P1A9NNMBK52 DCM17W5P1A9NNMBK52
340100101B DAM11W1SOL3NMB 340100101B DBM9W4SOL3NMB 340100101B DBM13W3SOL3NMB 340100101B DBM17W2SOL3NMB 340100101B DBM21W1SOL3NMB	DAM11W1SOL3NMBK52 DBM9W4SOL3NMBK52 DBM13W3SOL3NMBK52 DBM17W2SOL3NMBK52 DBM21W1SOL3NMBK52	340100101B DDM36W4P1AONNMB 340100101B DDM43W2P1AONNMB 340100101B DDM47W1P1AONNMB 340100101B DEM5W1S1A7NNMB 340100101B DAM7W2S1A7NNMB	DDM36W4P1AONNMBK52 DDM43W2P1AONNMBK52 DDM47W1P1AONNMBK52 DEM5W1S1A7NNMBK52 DAM7W2S1A7NNMBK52	340100101B DCM21WA4P1A9NNMB 340100101B DCM25W3P1A9NNMB 340100101B DCM27W2P1A9NNMB 340100101B DDM24W7P1A9NNMB 340100101B DDM36W4P1A9NNMB	DCM21WA4P1A9NNMBK52 DCM25W3P1A9NNMBK52 DCM27W2P1A9NNMBK52 DDM24W7P1A9NNMBK52 DDM36W4P1A9NNMBK52
340100101B DCM13W6SOL3NMB 340100101B DCM17W5SOL3NMB 340100101B DCM21WA4SOL3NMB 340100101B DCM25W3SOL3NMB 340100101B DCM27W2OL3NMB	DCM13W6SOL3NMBK52 DCM17W5SOL3NMBK52 DCM21WA4SOL3NMBK52 DCM25W3SOL3NMBK52 DCM27W2OL3NMBK52	340100101B DAM11W1S1A7NNMB 340100101B DBM9W4S1A7NNMB 340100101B DBM13W3S1A7NNMB 340100101B DBM17W2S1A7NNMB 340100101B DBM21W1S1A7NNMB	DAM11W1S1A7NNMBK52 DBM9W4S1A7NNMBK52 DBM13W3S1A7NNMBK52 DBM17W2S1A7NNMBK52 DBM21W1S1A7NNMBK52	340100101B DDM43W2P1A9NNMB 340100101B DDM47W1P1A9NNMB 340100101B DEM5W1SF179ANMB 340100101B DAM7W2SF179ANMB 340100101B DAM11W1SF179ANMB	DDM43W2P1A9NNMBK52 DDM47W1P1A9NNMBK52 DEM5W1SF179ANMBK52 DAM7W2SF179ANMBK52 DAM11W1SF179ANMBK52
340100101B DDM24W7SOL3NMB 340100101B DDM36W4SOL3NMB 340100101B DDM43W2SOL3NMB 340100101B DDM47W1SOL3NMB 340100101B DEM5W1POL3NMB	DDM24W7SOL3NMBK52 DDM36W4SOL3NMBK52 DDM43W2SOL3NMBK52 DDM47W1SOL3NMBK52 DEM5W1POL3NMBK52	340100101B DCM13W6S1A7NNMB 340100101B DCM17W5S1A7NNMB 340100101B DCM21WA4S1A7NNMB 340100101B DCM25W3S1A7NNMB 340100101B DCM27W2S1A7NNMB	DCM13W6S1A7NNMBK52 DCM17W5S1A7NNMBK52 DCM21WA4S1A7NNMBK52 DCM25W3S1A7NNMBK52 DCM27W2S1A7NNMBK52	340100101B DBM9W4SF179ANMB 340100101B DBM13W3SF179ANMB 340100101B DBM17W2SF179ANMB 340100101B DBM21W1SF179ANMB 340100101B DCM13W6SF179ANMB	DBM9W4SF179ANMBK52 DBM13W3SF179ANMBK52 DBM17W2SF179ANMBK52 DBM21W1SF179ANMBK52 DCM13W6SF179ANMBK52
340100101B DAM3W3POL3NMB 340100101B DAM7W2POL3NMB 340100101B DAM11W1POL3NMB 340100101B DBM9W4POL3NMB 340100101B DBM13W3POL3NMB	DAM3W3POL3NMBK52 DAM7W2POL3NMBK52 DAM11W1POL3NMBK52 DBM9W4POL3NMBK52 DBM13W3POL3NMBK52	340100101B DDM24W7S1A7NNMB 340100101B DDM36W4S1A7NNMB 340100101B DDM43W2S1A7NNMB 340100101B DDM47W1S1A7NNMB 340100101B DEM5W1P1A7NNMB	DDM24W7S1A7NNMBK52 DDM36W4S1A7NNMBK52 DDM43W2S1A7NNMBK52 DDM47W1S1A7NNMBK52 DEM5W1P1A7NNMBK52	340100101B DCM17W5SF179ANMB 340100101B DCM21WA4SF179ANMB 340100101B DCM25W3SF179ANMB 340100101B DCM27W2SF179ANMB 340100101B DDM24W7SF179ANMB	DCM17W5SF179ANMBK52 DCM21WA4SF179ANMBK52 DCM25W3SF179ANMBK52 DCM27W2SF179ANMBK52 DDM24W7SF179ANMBK52



Dimensions shown in mm
Specifications and dimensions subject to

www.ittcannon.com

ESA/SCC Cross Reference

ESA-SCC Part Number	ITT Cannon Part Number	ESA-SCC Part Number	ITT Cannon Part Number
340100101B DDM36W4SF179ANMB	DDM36W4SF179ANMBK52	340100415B	DM115740-13
340100101B DDM43W2SF179ANMB	DDM43W2SF179ANMBK52	340100419B	DM115740-12
340100101B DDM47W1SF179ANMB	DDM47W1SF179ANMBK52	340100412B	DM115742-15
340100101B DEM5W1PF179ANMB	DEM5W1PF179ANMBK52	340100416B	DM115742-14
340100101B DAM7W2PF179ANMB	DAM7W2PF179ANMBK52	340100420B	DM115742-13
340100101B DAM11W1PF179ANMB	DAM11W1PF179ANMBK52	340100413B	DM115741-7
340100101B DBM9W4PF179ANMB	DBM9W4PF179ANMBK52	340100417B	DM115741-8
340100101B DBM13W3PF179ANMB	DBM13W3PF179ANMBK52	340100414B	DM115743-20
340100101B DBM17W2PF179ANMB	DBM17W2PF179ANMBK52	340100418B	DM115743-22
340100101B DBM21W1PF179ANMB	DBM21W1PF179ANMBK52	340102207B	DE-59-20
340100101B DCM13W6PF179ANMB	DCM13W6PF179ANMBK52	340102208B	DE-60-20
340100101B DCM17W5PF179ANMB	DCM17W5PF179ANMBK52	340102209B	DA-59-20
340100101B DCM21WA4PF179ANMB	DCM21WA4PF179ANMBK52	340102210B	DA-60-20
340100101B DCM25W3PF179ANMB	DCM25W3PF179ANMBK52	340102211B	DB-59-20
340100101B DCM27W2PF179ANMB	DCM27W2PF179ANMBK52	340102212B	DB-60-20
340100101B DDM24W7PF179ANMB	DDM24W7PF179ANMBK52	340102213B	DC-59-20
340100101B DDM36W4PF179ANMB	DDM36W4PF179ANMBK52	340102214B	DC-60-20
340100101B DDM43W2PF179ANMB	DDM43W2PF179ANMBK52	340102215B	DD-59-20
340100101B DDM47W1PF179ANMB	DDM47W1PF179ANMBK52	340102216B	DD-60-20
340100101B DEM9SNMB	DEM9SNMBK52	340102201B	D20418-52
340100101B DAM15SNMB	DAM15SNMBK52	340102206B	D115418-70
340100101B DBM25SNMB	DBM25SNMBK52	340102258B	D20418-101
340100101B DCM37SNMB	DCM37SNMBK52	340102202B	D20419-74
340100101B DDM50SNMB	DDM50SNMBK52	340102203B	D20419-48
340100101B DEM9PNMB	DEM9PNMBK52	340102204B	D20420-67
340100101B DAM15PNMB	DAM15PNMBK52	340102205B	D20420-49
340100101B DBM25PNMB	DBM25PNMBK52	340102244B	D20419-73
340100101B DCM37PNMB	DCM37PNMBK52	340102245B	D20419-84
340100101B DDM50PNMB	DDM50PNMBK52	340102246B	D20420-63
340100101B DEM9SOL3NMB	DEM9SOL3NMBK52	340102247B	D20420-88
340100101B DAM15SOL3NMB	DAM15SOL3NMBK52	340102225B	DA19678-167
340100101B DBM25SOL3NMB	DBM25SOL3NMBK52	340102226B	DB19678-168
340100101B DCM37SOL3NMB	DCM37SOL3NMBK52	340102227B	DC19678-138
340100101B DDM50SOL3NMB	DDM50SOL3NMBK52	340102228B	DD19678-161
340100101B DEM9POL3NMB	DEM9POL3NMBK52	340102239B	DE19977-47
340100101B DAM15POL3NMB	DAM15POL3NMBK52	340102240B	DA19977-40
340100101B DBM25POL3NMB	DBM25POL3NMBK52	340102241B	DB19977-43
340100101B DCM37POL3NMB	DCM37POL3NMBK52	340102242B	DC19977-45
340100101B DDM50POL3NMB	DDM50POL3NMBK52	340102243B	DD19977-44
340100101B DEM9S1AONNMB	DEM9S1AONNMBK52	340102234B	DE24657-16
340100101B DAM15S1AONNMB	DAM15S1AONNMBK52	340102235B	DA24658-15
340100101B DBM25S1AONNMB	DBM25S1AONNMBK52	340102236B	DB24659-15
340100101B DCM37S1AONNMB	DCM37S1AONNMBK52	340102237B	DC24660-16
340100101B DDM50S1AONNMB	DDM50S1AONNMBK52	340102238B	DD24661-13
340100101B DEM9P1AONNMB	DEM9P1AONNMBK52	340102229B	DE115386-101A
340100101B DAM15P1AONNMB	DAM15P1AONNMBK52	340102230B	DA115386-104A
340100101B DBM25P1AONNMB	DBM25P1AONNMBK52	340102231B	DB115386-102A
340100101B DCM37P1AONNMB	DCM37P1AONNMBK52	340102232B	DC115386-100A
340100101B DDM50P1AONNMB	DDM50P1AONNMBK52	340102233B	DD115386-103A
340100101B DEM9S1A7NNMB	DEM9S1A7NNMBK52	340100501B	030-8882-002
340100101B DAM15S1A7NNMB	DAM15S1A7NNMBK52	340100502B	031-8944-000
340100101B DBM25S1A7NNMB	DBM25S1A7NNMBK52	340100503B	030-8848-020
340100101B DCM37S1A7NNMB	DCM37S1A7NNMBK52	340100504B	031-8787-020
340100101B DDM50S1A7NNMB	DDM50S1A7NNMBK52	340100505B	330-8782-001
340100101B DEM9P1A7NNMB	DEM9P1A7NNMBK52	340100506B	031-8843-001
340100101B DAM15P1A7NNMB	DAM15P1A7NNMBK52	340100507B	330-8944-000
340100101B DBM25P1A7NNMB	DBM25P1A7NNMBK52	340100508B	031-8902-000
340100101B DCM37P1A7NNMB	DCM37P1A7NNMBK52		
340100101B DDM50P1A7NNMB	DDM50P1A7NNMBK52		
340100101B DEM9S1A9NNMB	DEM9S1A9NNMBK52		

<u>Type</u>	<u>Description ESA/SCC</u>	<u>Description ITT P/N</u>
Straight PCB	340100102B DEM*15PNMB0L3	DEMA*5PNMB0L3K52
	340100102B DEM*15SNMB0L3	DEMA*15SNMB0L3K52
	340100102B DAM*26PNMB0L3	DAMA*26PNMB0L3K52
	340100102B DAM*26SNMB0L3	DAMA*26SNMB0L3K52
	340100102B DBM*44PNMB0L3	DBMA*44PNMB0L3K52
	340100102B DBM*44SNMB0L3	DBMA*44SNMB0L3K52
	340100102B DCM*62PNMB0L3	DCMA*62PNMB0L3K52
	340100102B DCM*62SNMB0L3	DCMA*62SNMB0L3K52
	340100102B DDM*78PNMB0L3	DDMA*78PNMB0L3K52
	340100102B DDM*78SNMB0L3	DDMA*78SNMB0L3K52
90° bent PCB (without brackets)	340100102B DEM*15PNMB1C0N	DEMA*15PNMB1C0NK52
	340100102B DEM*15SNMB1C0N	DEMA*15SNMB1C0NK52
	340100102B DAM*26PNMB1C0N	DAMA*26PNMB1C0NK52
	340100102B DAM*26SNMB1C0N	DAMA*26SNMB1C0NK52
	340100102B DBM*44PNMB1C0N	DBMA*44PNMB1C0NK52
	340100102B DBM*44SNMB1C0N	DBMA*44SNMB1C0NK52
	340100102B DCM*62PNMB1C0N	DCMA*62PNMB1C0NK52
	340100102B DCM*62SNMB1C0N	DCMA*62SNMB1C0NK52
	340100102B DDM*78PNMB1D0N	DDMA*78PNMB1D0NK52
	340100102B DDM*78SNMB1D0N	DDMA*78SNMB1D0NK52
90° bent PCB (with brackets)	340100102B DEM15PNMB1C7N	DEMA15PNMB1C7NK52
	340100102B DEM15SNMB1C7N	DEMA15SNMB1C7NK52
	340100102B DAM26PNMB1C7N	DAMA26PNMB1C7NK52
	340100102B DAM26SNMB1C7N	DAMA26SNMB1C7NK52
	340100102B DBM44PNMB1C7N	DBMA44PNMB1C7NK52
	340100102B DBM44SNMB1C7N	DBMA44SNMB1C7NK52
	340100102B DCM62PNMB1C7N	DCMA62PNMB1C7NK52
	340100102B DCM62SNMB1C7N	DCMA62SNMB1C7NK52
	340100102B DDM78PNMB1D7N	DDMA78PNMB1D7NK52
	340100102B DDM78SNMB1D7N	DDMA78SNMB1D7NK52
	340100102B DEM15PNMB1C9N	DEMA15PNMB1C9NK52
	340100102B DEM15SNMB1C9N	DEMA15SNMB1C9NK52
	340100102B DAM26PNMB1C9N	DAMA26PNMB1C9NK52
	340100102B DAM26SNMB1C9N	DAMA26SNMB1C9NK52
	340100102B DBM44PNMB1C9N	DBMA44PNMB1C9NK52
	340100102B DBM44SNMB1C9N	DBMA44SNMB1C9NK52
340100102B DCM62PNMB1C9N	DCMA62PNMB1C9NK52	
340100102B DCM62SNMB1C9N	DCMA62SNMB1C9NK52	
340100102B DDM78PNMB1D9N	DDMA78PNMB1D9NK52	
340100102B DDM78SNMB1D9N	DDMA78SNMB1D9NK52	

*Hardware Modifier, see page 5.



Dimensions shown in mm
Specifications and dimensions subject to

www.ittcannon.com

<u>Type</u>	<u>Description ESA/SCC</u>	<u>Description ITT P/N</u>
Crimp (Without Contacts)	340100201B DEMA*15PNMBF0	DEMA*15PNMBK52F0
	340100201B DEMA*15SNMBF0	DEMA*15SNMBK52F0
	340100201B DAMA*26PNMBF0	DAMA*26PNMBK52F0
	340100201B DAMA*26SNMBF0	DAMA*26SNMBK52F0
	340100201B DBMA*44PNMBF0	DBMA*44PNMBK52F0
	340100201B DBMA*44SNMBF0	DBMA*44SNMBK52F0
	340100201B DCMA*62PNMBF0	DCMA*62PNMBK52F0
	340100201B DCMA*62SNMBF0	DCMA*62SNMBK52F0
	340100201B DDMA*78PNMBF0	DDMA*78PNMBK52F0
	340100201B DDMA*78SNMBF0	DDMA*78SNMBK52F0
	340100202B DEMA*15PNMBF0	DEMA*15PNMBK52F0
	340100202B DEMA*15SNMBF0	DEMA*15SNMBK52F0
	340100202B DAMA*26PNMBF0	DAMA*26PNMBK52F0
	340100202B DAMA*26SNMBF0	DAMA*26SNMBK52F0
	340100202B DBMA*44PNMBF0	DBMA*44PNMBK52F0
	340100202B DBMA*44SNMBF0	DBMA*44SNMBK52F0
	340100202B DCMA*62PNMBF0	DCMA*62PNMBK52F0
	340100202B DCMA*62SNMBF0	DCMA*62SNMBK52F0
	340100202B DDMA*78PNMBF0	DDMA*78PNMBK52F0
340100202B DDMA*78SNMBF0	DDMA*78SNMBK52F0	
Crimp (With Contacts)	340100201B DEMA*15PNMB	DEMA*15PNMBK52
	340100201B DEMA*15SNMB	DEMA*15SNMBK52
	340100201B DAMA*26PNMB	DAMA*26PNMBK52
	340100201B DAMA*26SNMB	DAMA*26SNMBK52
	340100201B DBMA*44PNMB	DBMA*44PNMBK52
	340100201B DBMA*44SNMB	DBMA*44SNMBK52
	340100201B DCMA*62PNMB	DCMA*62PNMBK52
	340100201B DCMA*62SNMB	DCMA*62SNMBK52
	340100201B DDMA*78PNMB	DDMA*78PNMBK52
	340100201B DDMA*78SNMB	DDMA*78SNMBK52
	340100202B DEMA*15PNMB	DEMA*15PNMBK52
	340100202B DEMA*15SNMB	DEMA*15SNMBK52
	340100202B DAMA*26PNMB	DAMA*26PNMBK52
	340100202B DAMA*26SNMB	DAMA*26SNMBK52
	340100202B DBMA*44PNMB	DBMA*44PNMBK52
	340100202B DBMA*44SNMB	DBMA*44SNMBK52
	340100202B DCMA*62PNMB	DCMA*62PNMBK52
	340100202B DCMA*62SNMB	DCMA*62SNMBK52
	340100202B DDMA*78PNMB	DDMA*78PNMBK52
340100202B DDMA*78SNMB	DDMA*78SNMBK52	

*Hardware Modifier, see page 5.

Dimensions shown in mm
Specifications and dimensions subject to

www.ittcannon.com



<u>Type</u>	<u>Description ESA/SCC</u>	<u>Description ITT P/N</u>
Connector Savers (With Contacts)	340102001B DEBMA-9PSNMB	DEBMA9PSNMBK52
	340102001B DABMA15PSNMB	DABMA15PSNMBK52
	340102001B DBBMA25PSNMB	DBBMA25PSNMBK52
	340100201B DCBMA37PSNMB	DCBMA37PSNMBK52
	340100201B DDBMA50PSNMB	DDBMA50PSNMBK52
	340102002B DEBMA15PSNMB	DEBM159PSNMBK52
	340102002B DABMA26PSNMB	DABMA26PSNMBK52
	340102002B DBBMA44PSNMB	DBBMA44PSNMBK52
	340100202B DCBMA62PSNMB	DCBM62PSNMBK52
	340100202B DDBMA78PSNMB	DDBMA78PSNMBK52

Panel Mounting

Figure 1A

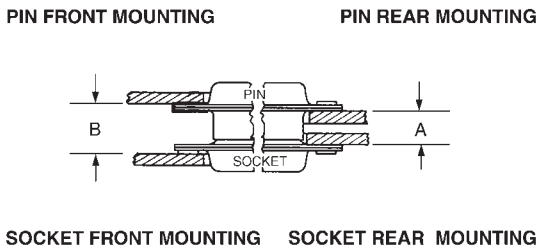

Figure 1B

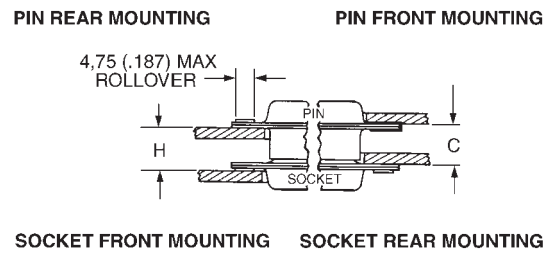

Figure 2

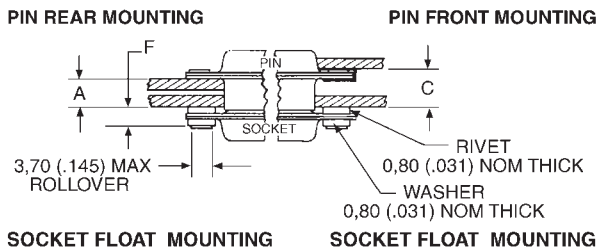

Figure 3

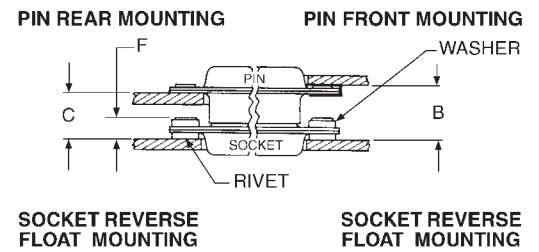

Figure Number	Combination of Mated Connectors		A + 0,76 (.030)	B + 0,76 (.030)	C + 0,76 (.030)	F ± 0,25 (.010)	H + 0,76 (.030)	
	Size	Pin (See Note Below)						Socket
1A, 1B	A, E	Standard	Standard	6,35 (.250)	8,63 (.340)	7,49 (.295)	—	7,49 (.295)
1A, 1B	B, C, D	Standard	Standard	6,04 (.238)	8,71 (.343)	7,56 (.298)	—	7,18 (.283)
2	A, E	Standard	Float Mount	5,53 (.218)	—	6,68 (.263)	3,04 (.120)	—
2	B, C, D	Standard	Float Mount	5,23 (.206)	—	6,75 (.266)	3,04 (.120)	—
2	A, E	Float Mount	Standard	5,53 (.218)	—	6,68 (.263)	3,04 (.120)	—
2	B, C, D	Float Mount	Standard	5,23 (.206)	—	6,37 (.251)	3,30 (.130)	—
3	A, E	Standard	Reverse Float Mount	—	9,09 (.358)	7,95 (.313)	3,04 (.120)	—
3	B, C, D	Standard	Reverse Float Mount	—	9,16 (.361)	7,64 (.301)	3,04 (.120)	—
3	A, E	Reverse Float Mount	Standard	—	9,09 (.358)	7,95 (.313)	3,04 (.120)	—
3	B, C, D	Reverse Float Mount	Standard	—	9,01 (.355)	7,87 (.310)	3,30 (.130)	—

Notes:

1. A, B, C and H are dimensions between panels and represent the recommended limit to be used in the design of the connector mounting method.
2. It is recommended that only one assembly, either pin or socket, be float mounted.
3. Standard pin assemblies contained 0,38 (.015) thick front shells on E and A sizes; 0,61 (.024) thick front shells on B, C, and D sizes.
4. Standard connectors accommodate a #4 screw. Float mount connectors accommodate a #2 screw.

Panel Cutouts

Standard Cutout

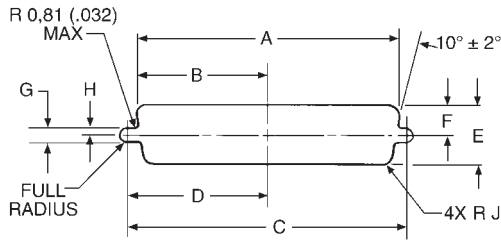

Rear Mounting Cutout (Optional)

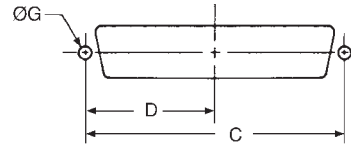

Front Panel Mounting

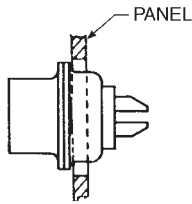

Standard Shell

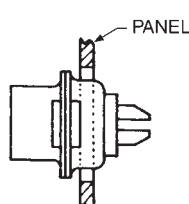

Dual Float Mount Shell

Rear Panel Mounting

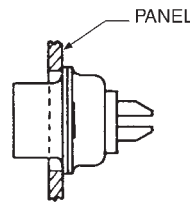

Standard Shell

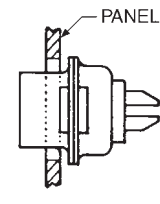

Dual Float Mount Shell

Standard Shell

Shell Size	Mounting Method	A ± 0,13 (.005)	B ± 0,13 (.005)	C ± 0,13 (.005)	D ± 0,13 (.005)	E ± 0,13 (.005)	F ± 0,13 (.005)	G ± 0,05 (.002)	H ± 0,05 (.002)	J ± 0,05 (.002)
DE	Front	22,19 (.874)	11,09 (.437)	24,99 (.984)	12,49 (.492)	13,03 (.513)	6,52 (.257)	3,04 (.120)	1,52 (.060)	2,10 (.083)
	Rear	20,47 (.806)	10,23 (.403)	24,99 (.984)	12,49 (.492)	11,40 (.449)	5,71 (.225)	3,04 (.120)	1,52 (.060)	3,35 (.132)
DA	Front	30,53 (1.202)	15,26 (.601)	33,32 (1.312)	16,66 (.656)	13,03 (.513)	6,52 (.257)	3,04 (.120)	1,52 (.060)	2,10 (.083)
	Rear	28,80 (1.134)	14,40 (.567)	33,32 (1.312)	16,66 (.656)	11,40 (.449)	5,71 (.225)	3,04 (.120)	1,52 (.060)	3,35 (.132)
DB	Front	44,27 (1.743)	22,14 (.872)	47,04 (1.852)	23,52 (.926)	13,03 (.513)	6,52 (.257)	3,04 (.120)	1,52 (.060)	2,10 (.083)
	Rear	42,51 (1.674)	21,25 (.837)	47,04 (1.852)	23,52 (.926)	11,40 (.449)	5,71 (.225)	3,04 (.120)	1,52 (.060)	3,35 (.132)
DC	Front	60,73 (2.391)	30,37 (1.196)	63,50 (2.500)	31,75 (1.250)	13,03 (.513)	6,52 (.257)	3,04 (.120)	1,52 (.060)	2,10 (.083)
	Rear	59,08 (2.326)	29,54 (1.163)	63,50 (2.500)	31,75 (1.250)	11,40 (.449)	5,71 (.225)	3,04 (.120)	1,52 (.060)	3,35 (.132)
DD	Front	58,34 (2.297)	29,18 (1.149)	61,11 (2.406)	30,55 (1.203)	15,82 (.623)	7,92 (.312)	3,04 (.120)	1,52 (.060)	2,10 (.083)
	Rear	56,33 (2.218)	28,16 (1.109)	61,11 (2.406)	30,55 (1.203)	14,09 (.555)	7,06 (.278)	3,04 (.120)	1,52 (.060)	3,35 (.132)

Dual Float Mount Shell

Shell Size	Mounting Method	A ± 0,13 (.005)	B ± 0,13 (.005)	C ± 0,13 (.005)	D ± 0,13 (.005)	E ± 0,13 (.005)	F ± 0,13 (.005)	G ± 0,05 (.002)	H ± 0,05 (.002)	J ± 0,05 (.002)
DE	Front	23,01 (.906)	11,50 (.453)	24,99 (.984)	12,49 (.492)	13,84 (.545)	6,93 (.273)	2,23 (.088)	1,11 (.044)	2,10 (.083)
	Rear	21,28 (.838)	10,64 (.419)	24,99 (.984)	12,49 (.492)	12,21 (.481)	6,12 (.241)	2,23 (.088)	1,11 (.044)	3,35 (.132)
DA	Front	31,34 (1.234)	15,67 (.617)	33,32 (1.312)	16,66 (.656)	13,84 (.545)	6,93 (.273)	2,23 (.088)	1,11 (.044)	2,10 (.083)
	Rear	29,61 (1.166)	14,80 (.583)	33,32 (1.312)	16,66 (.656)	12,21 (.481)	6,12 (.241)	2,23 (.088)	1,11 (.044)	3,35 (.132)
DB	Front	45,08 (1.775)	22,55 (.888)	47,04 (1.852)	23,52 (.926)	13,84 (.545)	6,93 (.273)	2,23 (.088)	1,11 (.044)	2,10 (.083)
	Rear	43,33 (1.706)	21,66 (.853)	47,04 (1.852)	23,52 (.926)	12,21 (.481)	6,12 (.241)	2,23 (.088)	1,11 (.044)	3,35 (.132)
DC	Front	61,54 (2.423)	30,78 (1.212)	63,50 (2.500)	31,75 (1.250)	13,84 (.545)	6,93 (.273)	2,23 (.088)	1,11 (.044)	2,10 (.083)
	Rear	59,79 (2.354)	29,89 (1.177)	63,50 (2.500)	31,75 (1.250)	12,21 (.481)	6,12 (.241)	2,23 (.088)	1,11 (.044)	3,35 (.132)
DD	Front	59,15 (2.329)	29,59 (1.165)	61,11 (2.406)	30,55 (1.203)	16,63 (.655)	8,33 (.328)	2,23 (.088)	1,11 (.044)	2,10 (.083)
	Rear	57,15 (2.250)	28,57 (1.125)	61,11 (2.406)	30,55 (1.203)	14,90 (.587)	7,46 (.294)	2,23 (.088)	1,11 (.044)	3,35 (.132)



Hardware Views (Standard)

Through Hole (Eyelet)

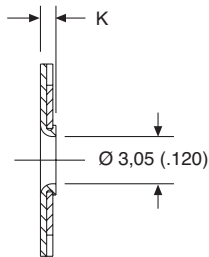

Tab Shells (K)

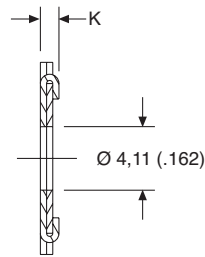

Clinch Nut (E)

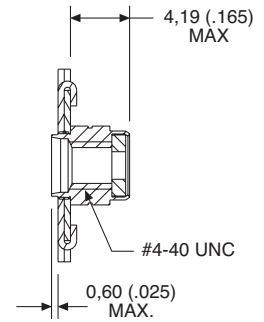

Dimensions — Plug

Shell Size	K	K
	$\pm 0,317 (.0125)$	$\pm 0,25 (.010)$
DE	1,206 (.0475)	—
DA	1,206 (.0475)	—
DB	—	1,52 (.060)
DC	—	1,52 (.060)
DD	—	1,52 (.060)

Dual Float Mount (Y)

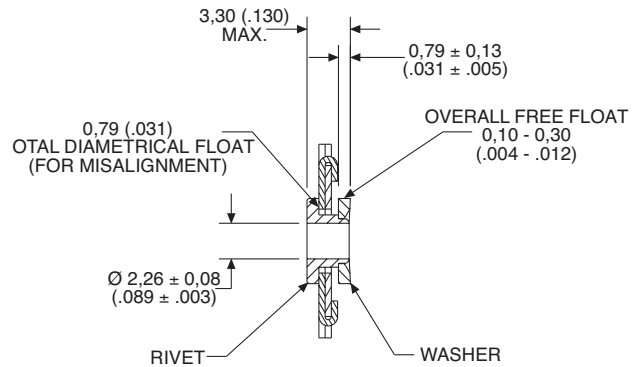

Dimensions — Receptacle

Shell Size	K
	$\pm 0,318 (.0125)$
DE	1,206 (.0475)
DA	1,206 (.0475)
DB	1,206 (.0475)
DC	1,206 (.0475)
DD	1,206 (.0475)

Alternate Bracket Configuration

Supplied with connectors without boardlocks. Standard Footprint (P)

European Footprint (P)

Dimensions

Shell Size	R	S
	$\pm 0,25 (.010)$	$\pm 0,25 (.010)$
DE, DA, DB, DC	11,61 (.457)	12,78 (.503)
DD	12,78 (.503)	13,95 (.549)

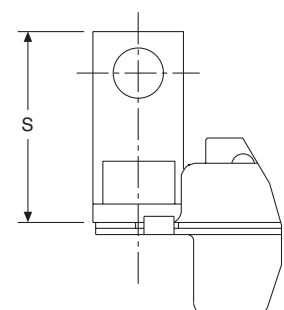
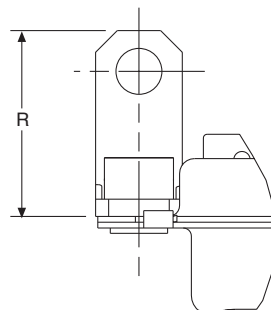

Hardware Views (European)

Through Hole

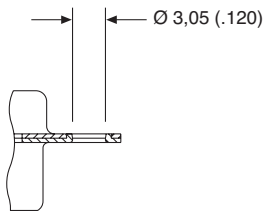

Clinch Nut (X/E)

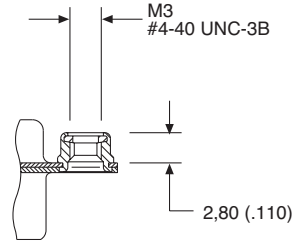

Plastic Bracket with Bushing (1A5N)

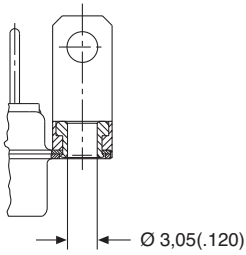

Plastic Bracket with Captive Nut (1ATN/1AVN)

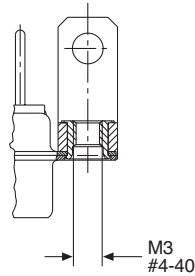

Plastic Bracket with Post (1APN/1A6N)

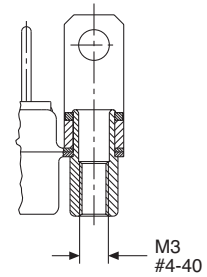

Metal Bracket with Bushing (1AFN)

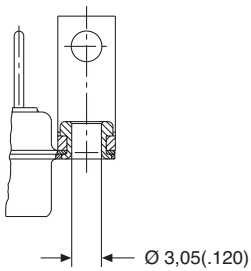

Metal Bracket with Captive Nut (1A9N/1A7N)

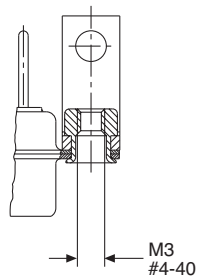

Metal Bracket with Post (1AHN/1A8N)

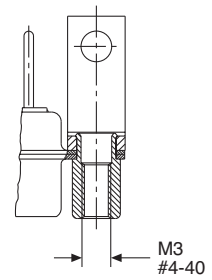

Plug

Face View Pin Insert

Shell Size	E	E	E	A	A	A	A
Contact Arrangement	2W2	2WK2	5W1	3W3	3WK3	7W2	11W1
No. of Size 20 Cavities	0#20	0#20	4#20	0#20	0#20	5#20	10#20
No. of Size 8 Cavities	2#8	2#8	1#8	3#8	3#8	2#8	1#8

Shell Size	B	B	B
Contact Arrangement	5W54	9W4	13W3
No. of Size 20 Cavities	0#20	5#20	10#20
No. of Size 8 Cavities	5#8	4#8	3#8

Shell Size	B	B
Contact Arrangement	17W2	21W1
No. of Size 20 Cavities	15#20	20#20
No. of Size 8 Cavities	2#8	1#8

Shell Size	C	C	C
Contact Arrangement	8W8	13W6	17W5
No. of Size 20 Cavities	0#20	7#20	12#20
No. of Size 8 Cavities	8#8	6#8	5#8

Shell Size	C	C	C
Contact Arrangement	21WA4	25W3	27W2
No. of Size 20 Cavities	17#20	22#20	25#20
No. of Size 8 Cavities	4#8	3#8	2#8

Shell Size	D	D
Contact Arrangement	24W7	36W4
No. of Size 20 Cavities	17#20	32#20
No. of Size 8 Cavities	7#8	4#8

Shell Size	D	D
Contact Arrangement	43W2	47W1
No. of Size 20 Cavities	41#20	46#20
No. of Size 8 Cavities	2#8	1#8

Dimensions shown in mm
 Specifications and dimensions subject to
www.ittcannon.com



Receptacle
Face View Socket Insert

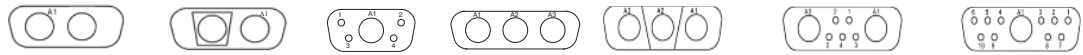

Shell Size	E	E	E	A	A	A	A
Contact Arrangement	2W2	2WK2	5W1	3W3	3WK3	7W2	11W1
No. of Size 20 Cavities	0#20	0#20	4#20	0#20	0#20	5#20	10#20
No. of Size 8 Cavities	2#8	2#8	1#8	3#8	3#8	2#8	1#8

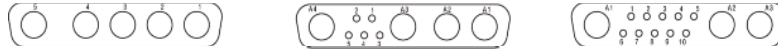

Shell Size	B	B	B
Contact Arrangement	5W5	9W4	13W3
No. of Size 20 Cavities	0#20	5#20	10#20
No. of Size 8 Cavities	5#8	4#8	3#8



Shell Size	B	B
Contact Arrangement	17W2	21W1
No. of Size 20 Cavities	15#20	20#20
No. of Size 8 Cavities	2#8	1#8

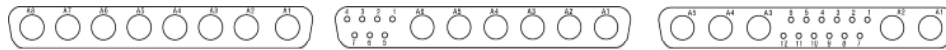

Shell Size	C	C	C
Contact Arrangement	8W8	13W6	17W5
No. of Size 20 Cavities	0#20	7#20	12#20
No. of Size 8 Cavities	8#8	6#8	5#8



Shell Size	C	C	C
Contact Arrangement	21WA4	25W3	27W2
No. of Size 20 Cavities	17#20	22#20	25#20
No. of Size 8 Cavities	4#8	3#8	2#8



Shell Size	D	D
Contact Arrangement	24W7	36W4
No. of Size 20 Cavities	17#20	32#20
No. of Size 8 Cavities	7#8	4#8



Shell Size	D	D
Contact Arrangement	43W2	47W1
No. of Size 20 Cavities	41#20	46#20
No. of Size 8 Cavities	2#8	1#8



Plug

Face View Pin Insert

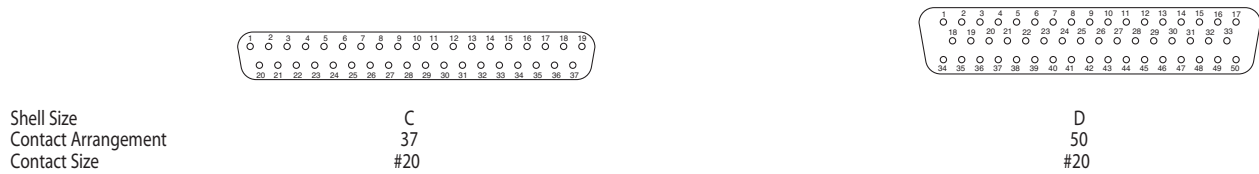
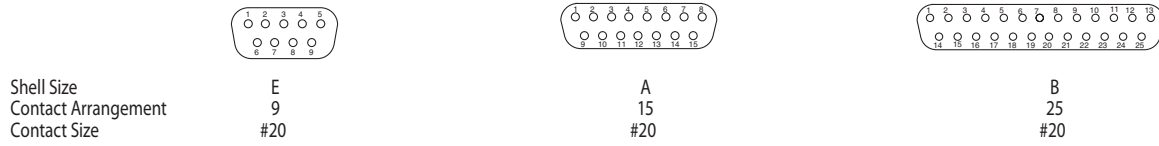

Receptacle

Face View Socket Insert

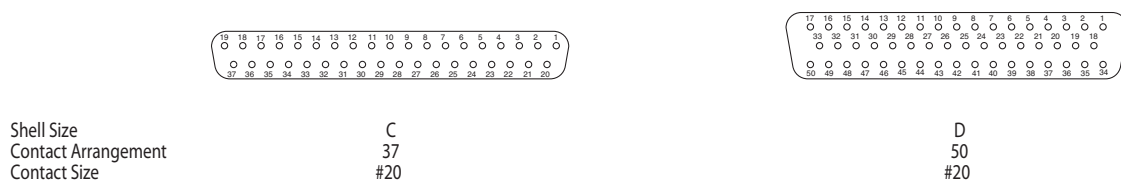
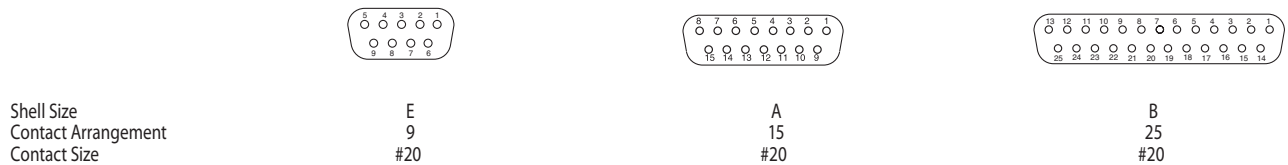

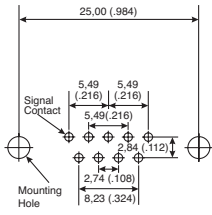

9 Contacts

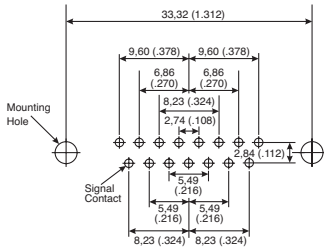

15 Contacts

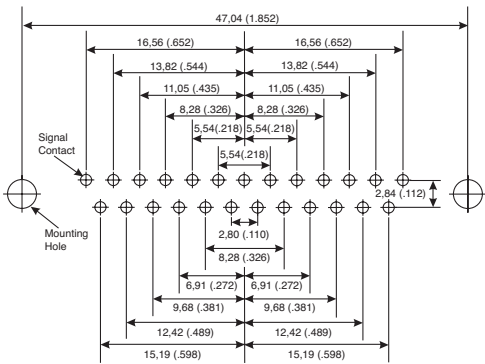

25 Contacts

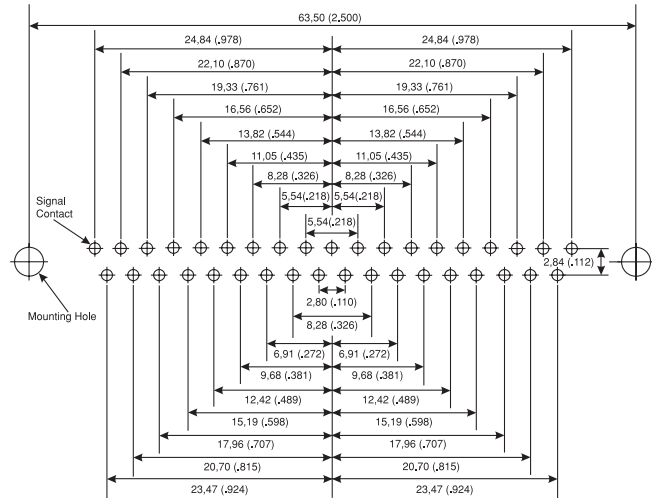

37 Contacts

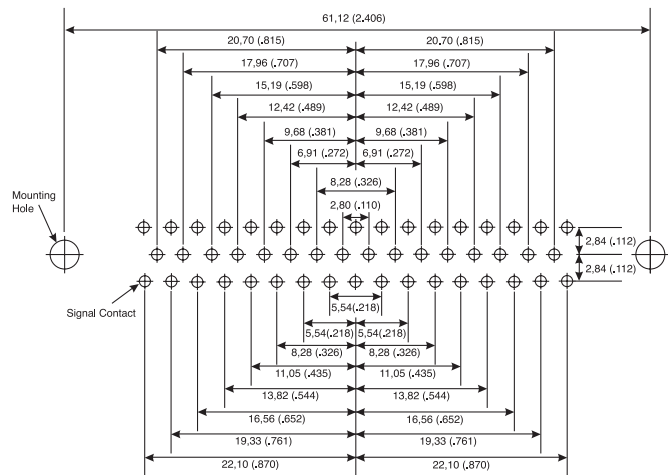

50 Contacts

Signal Contact	Recommended PCB Hole
0,60 (.024)	1,00 (.039)
0,76 (.030)	1,14 (.045)
1,00 (.040)	1,40 (.055)
Mounting Type	Recommended PCB Hole
Without Boardlock	3,05 (.120)
With Boardlock	3,10 (.122)



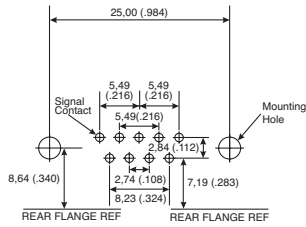

9 Contacts

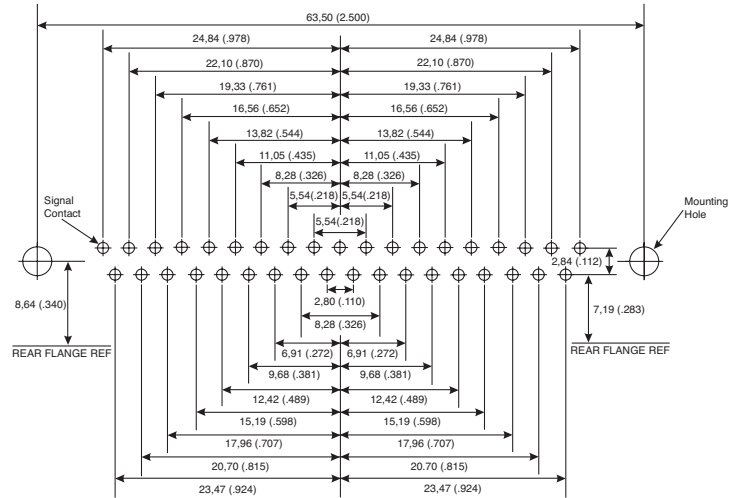

37 Contacts

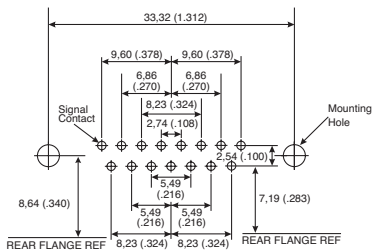

15 Contacts

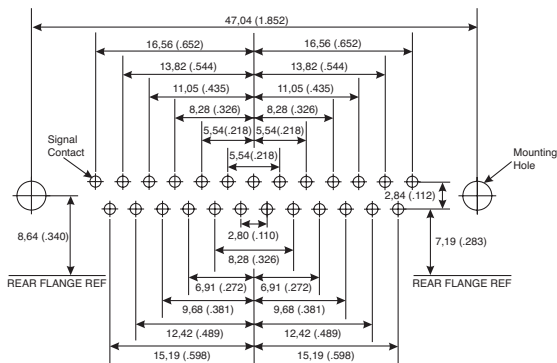

25 Contacts

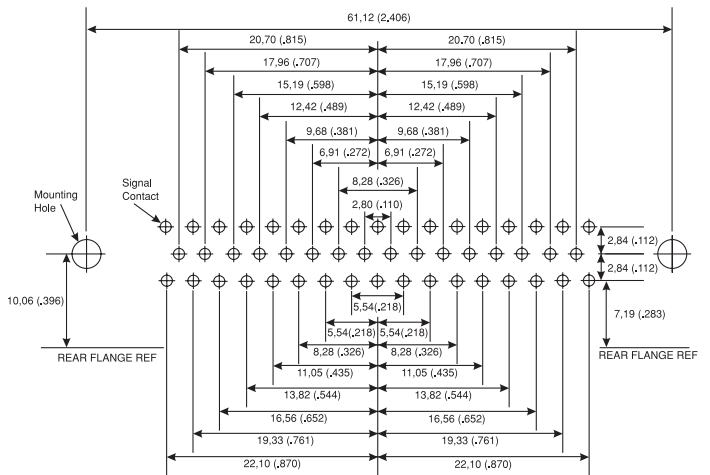

50 Contacts

Signal Contact	Recommended PCB Hole
0,76 (.030)	1,14 (.045)
1,00 (.040)	1,40 (.055)
Mounting Type	Recommended PCB Hole
Without Boardlock	3,05 (.120)
With Boardlock	3,10 (.122)

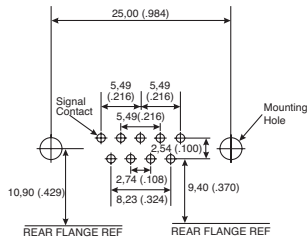

9 Contacts

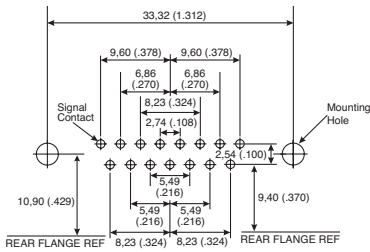

15 Contacts

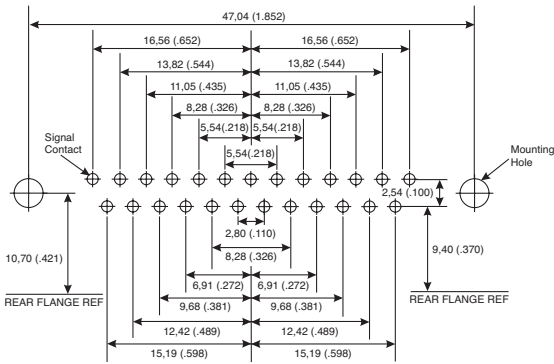

25 Contacts

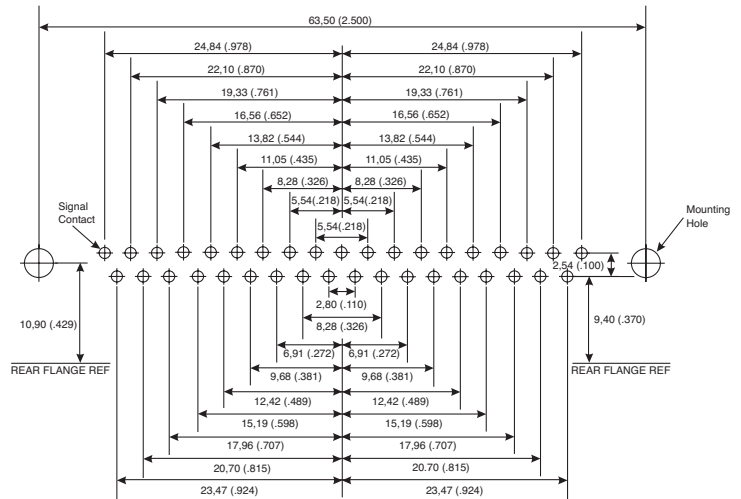

37 Contacts

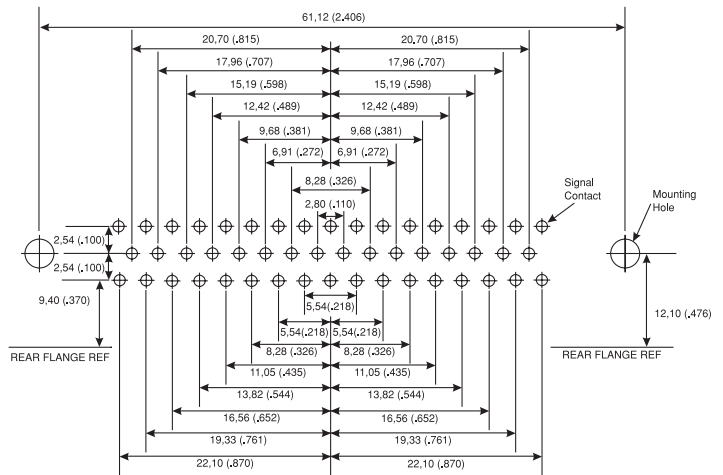

50 Contacts

Signal Contact	Recommended PCB Hole
0,60 (.024)	1,00 (.039)
Mounting Type	Recommended PCB Hole
Without Boardlock	3,05 (.120)
With Boardlock	3,10 (.122)

PCB Hole Pattern

Face view, pin insert for plug

(use a mirror image for receptacle)

SIZE E
15 Contacts

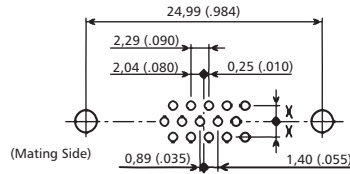

SIZE A
26 Contacts

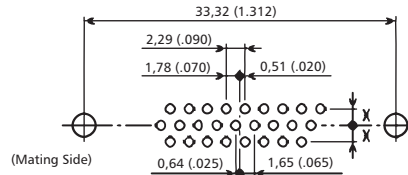

SIZE B
44 Contacts

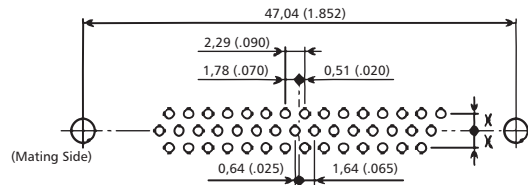

SIZE C
62 Contacts

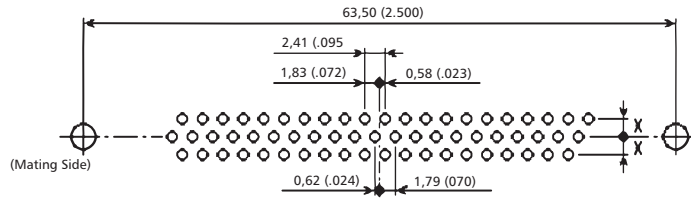

SIZE D
78 Contacts

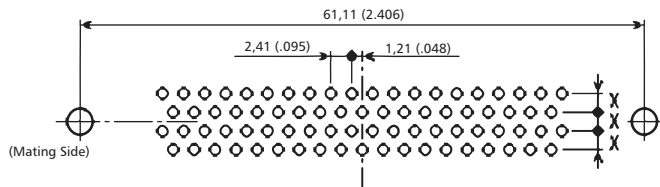

SIZE F
104 Contacts

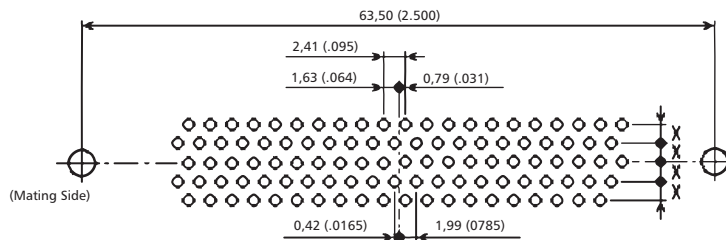

Dimension X

1,98 (.078) for sizes E, A, B, C

2,08 (.082) for size D

Recommended PC hole for signal contacts

0,90 (.035) min for terminations 0,51 (.020)

1,00 (.040) min for terminations 0,57 (.022)

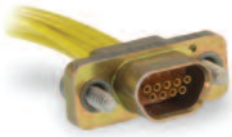

MDM connectors are used in applications requiring highly reliable, extremely small, light-weight connectors with higher density contact configurations than available in traditional rectangular connectors. They are available in 8 shell sizes accommodating from 9 to 100 contacts, and special arrangements of power and coaxial contacts.

These connectors are designed to meet the rapidly increasing demands for an environmental, high performance, rugged, moisture-sealed microminiature connector. This connector

employs size 24 MICROPIN™/MICROSOCKET™ contacts on .050 (1.27) centers in a contact density identical to the standard MICRO-D connector series, but with these additional features:

- Aluminum shells to provide greater strength, prevent chipping, cracking or breaking, offer electromagnetic (EMI) and RFI shielding.
- Silicone elastomer compression interfacial seal to provide a moisture and humidity seal between each contact and between contacts and shell.

Specifications

STANDARD MATERIALS AND FINISHES

Shell	- 6061-T6 Aluminum alloy per QQ-A-200/8, yellow chromate/cadmium, Type II, Class 3 over electroless nickel per SAE AMS-C-26074, Class 4.
Insulator	- Liquid Crystal Polymer per MIL-M-24519, Type GLCP-30F (9-100) - Glass filled diallyl phthalate per MIL-M-14, Type SDGF (7*2 and 24*4) - Polyphenylene sulfide per MIL-M-24519, Type GST-40F (16*5) - Polyester per MIL-M-24519, Type GPT-30F (10*10)
Contacts	- Copper alloy, gold plate
Mounting Hardware Kit, Jackpost (3) items	- 300 Series stainless steel, passivate
Washer	- 400 Series stainless steel, passivate
Standard Epoxy	- Hysol EE4215/HD3561, color black or Hysol EE4198/HD3561, color green

MECHANICAL FEATURES

Coupling	- Friction/jackscrews
Polarization	- Keystone-shaped shells
Contact Spacing Centers	- .050 (1.27)
Shell Styles	- Plug and receptacle
No. of Contacts	- 9 thru 100 signal; 5 signal/2 coaxial; 5 signal/2 power; 11 signal/5 coaxial; 11 signal/5 power; 0 signal/10 coaxial; 0 signal/10 power; 20 signal/4 coaxial; 20 signal/4 power
Coaxial Cable	- RG - 178/U
Wire Size	- #24 thru #32 AWG
Contact Termination	- Multiple indent crimp

Performance Data

The table below summarizes the results of key tests performed in accordance with MIL-STD-1344, where applicable. Data is applicable to standard connectors with standard termination. Variations may affect this data, so please consult customer service for further information on your requirements.

Test	Method	Criteria of Acceptance
Dielectric Withstanding Voltage	Method 3001: 600 VAC at sea level 150 VAC at 70,00' altitude	No breakdown No breakdown
Insulation Resistance	Method 3003	5,000 megohms minimum
Thermal Shock	Method 1003, Condition A: - 55°C to +125°C	No physical damage
Physical Shock	Method 2004, Condition E: 50 G's, 3 axes, 6 millisecond duration sawtooth pulse	No physical damage No loss of continuity > 1 µsec
Vibration	Method 2005, Condition IV: 20 G's, 10-2,000 Hz. 12 hrs	No physical damage No loss of continuity > 1 µsec
Durability	500 cycles of mating and unmating, 500 CPH max.	No mechanical or electrical defects
Moisture Resistance	Method 1002, Type II, omit steps 7a & 7b	Insulation resistance > 100 megohms
Salt Spray	Method 1001, Condition B: 48 hours	Shall be capable of mating and unmating, and meet contact resistance requirements
Contact Resistance (MIL-STD-202)	Method 1001, Condition B: At 3 amps At 1 milliamp	8 milliohms maximum 10 milliohms maximum
Contact Retention	Per MIL-DTL-83513	5 lb. minimum axial load



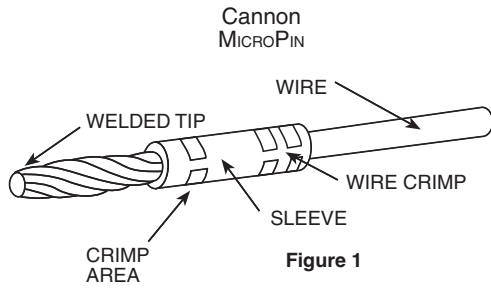

Figure 1
Pos-A-Line Contact Alignment

The flexible twist-pin is recessed into the insulator and the rigid socket is exposed, reversing the traditional positions of pin and socket. During mating, the socket is guided into the pin insulator by the lead-in chamfer. The pin is kept from flexing beyond the socket capture radius by the walls of the cavity. The hemispherical weld of controlled radius at the tip of the pin combines with the lead-in chamfers of the socket contact and the pin insulator to cam the pin into alignment. By controlling the welding process and the dimensions of the socket contact and the insulators, it is impossible for the recessed pin to escape the socket capture radius.

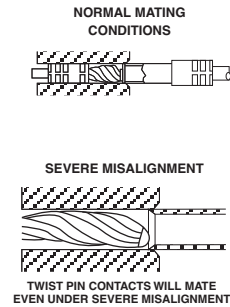

Figure 2

Twist Pin Contact Technology

The foundation of ITT’s Cannon Micro Connector portfolio starts with ITT’s innovative twist pin contact system. This system was originally developed in the early 1960’s and ITT was one of the original interconnect companies to license this technology and improve it. Our forty five years of experience in manufacturing and establishing a fully automated manufacturing system for this contact has truly given ITT the foremost knowledge in twist pin contact technology.

As the core of our micro products, the twist pin contact offers a superior electrical and mechanical system that outperforms traditional machined or stamped electrical contract systems. ITT’s twist pin system consists of the Micro Socket and the Micro pin or Twist pin. Figure 1 show the basic contacts.

Figure 1

The twist pin contact system consists of several stranded cores making up the wire bundle. The strands are subsequently heat treated and a weld is performed on the tip of each contact. Crimp sleeves are then inserted over the contact and crimp areas are defined to produce a seamless crimp system. The entire twist pin system is referred by ITT as a Pos-A-Line contact alignment system. Our reference to this system identifies that the flexible twist pin is recessed into the insulator and the rigid socket is exposed thus reversing the traditional positions of the pin and socket. During the mating sequence, the socket is guided into the pin insulator by the lead-in chamfer. The pin is kept from flexing beyond the socket capture radius by the walls of the cavity. The hemispherical weld of controlled radius at the tip of the pin combines with the lead-in chamfer of the socket contact and the pin insulator to cam the pin in alignment. ITT has developed a very robust Six Sigma manufacturing process that controls the welding process as well as the dimensions of the socket con-

tact and insulator material. The net result is a contact system that makes it impossible for the recessed pin to escape the socket capture radius. Figure 2 shows the twist pin features as well as mating and severe misalignment conditions.

The advantages of ITT’s twist pin contact system are many and have been field proven in the most demanding applications and environments for over forty five years. Some of these advantages include:

- Seven points of electrical contact (Micro 0.050-inch & Centi Line 0.075-inch Interconnect Products)
- Five points of electrical contact (Nano 0.025-inch Interconnect Products)
- Contact and crimp sleeve materials carefully optimized for extremely reliable crimps- No design tradeoffs
- Seamless crimp sleeves
- Multiple 4-indent wire crimps standard and smaller bore micro socket contacts
- Standard integral tail & thru bundle micro pin contacts (high density packaging)
- High mating cycles
- High current handling capabilities
- System qualification in numerous Aerospace, Defense Electronic, and high temperature Geophysical applications.
- Wide array of wire terminations

The advantages listed above are by no means inclusive of ITT’s innovative product improvement processes. Moving forward, ITT plans to introduce additional new product features supporting enhanced twist pin contact performance.

How to Order

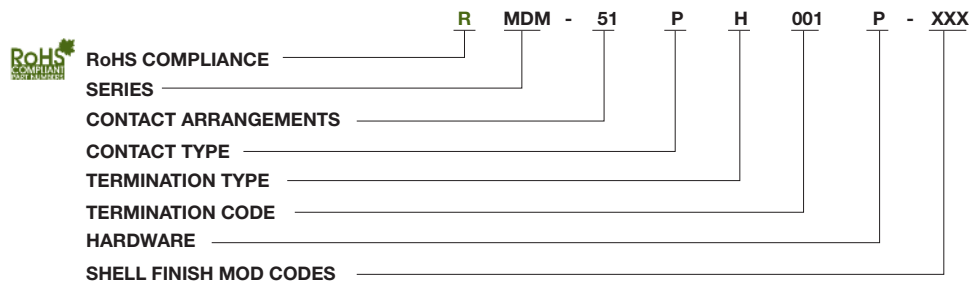

SERIES

MDM: (Size 9-100) Liquid Crystal Polymer (LCP)
 MDM: (Combo Layout) Diallyl Phthalate (DAP)

CONTACT ARRANGEMENTS

9-15-21-25-31-37-51-100 (standard)
 16C5, 10C10, 7C2, 24C4 (coaxial) } or combination of
 16P5, 10P10, 7P2, 24P4 (power) } coax and power

CONTACT TYPE

P - Pin S - Socket

TERMINATION TYPE

H - Harness-insulated wire.
 L - Solid-uninsulated wire.
 S - Solder pot to accept #26 AWG MAX.
 harness wire. (Not available with power
 contact arrangements.)

HARDWARE

M - Military specification hardware, see
 page 11 for military hardware codes.
 P - Jackpost
 K - Jackscrew-standard profile
 L - Jackscrew-low profile
 F - Float mount
 B - No hardware standard
 .091 (2.31) dia. hole for sizes 9-51;
 .120 (3.05) dia. hole for size 100.
 A - .125 (3.18) dia. mounting holes for sizes 9-51;
 .166 (4.22) dia. hole for size 100.
 B1 - .1475 (3.75) dia. hole for size 100
 (Per MIL-DTL-83513)
 S - #2- 56 Clinch Nut

TERMINATION CODE*

See H code chart for insulated ETFE wire designations.
 See L code chart for solid insulated gold plated copper wire

SHELL FINISH MOD CODES

No Number - (Standard cadmium/yellow
 chromate over nickel
 A174 - Electroless nickel
 A172 - Gold over nickel

“H” Code Chart

22759/33-26
 Wire, Electrical, Fluoropolymer-insulated,
 Crosslinked, Modified, ETFE, Lightweight,
 Silver-Coated, High strength Copper Alloy
 200 Degrees C, 600 Volt.

Length in inches	10 Color Repeat System 1		
	White	Repeat	System 1
1	V30	W30	X30
2	V24	W24	X24
3	V20	W20	X20
4	V33	W33	X33
5	V31	W31	X31
6	V19	W19	X19
8	V26	W26	X26
9	V15	W15	X15
10	V29	W29	X29
12	V28	W28	X28
16	V39	W39	X39
17	V36	W36	X36
18	V01	W01	X01
20	V38	W38	X38
21	V55	W55	X55
24	V09	W09	X09
30	V10	W10	X10
35	V18	W18	X18
36	V11	W11	X11
40	V37	W37	X37
42	V12	W12	X12
48	V13	W13	X13
50	V40	W40	X40
60	V14	W14	X14
72	V17	W17	X17
80	V32	W32	X32
92	V22	W22	X22
96	V35	W35	X35
120	V42	W42	X42
180	V43	W43	X43

“L” Code Chart

Sorted By Length

Wire Length, in.		Code
Decimal	Fraction	
0.080		L63
0.094	3/32	L62
0.110		L65
0.125	1/8	L61
0.140		L67
0.150		L56
0.171		L66
0.187	3/16	L17
0.190		L57
0.210		L59
0.250	1/4	L39
0.312	3/8	L60
0.375	3/8	L58
0.380		L64
0.500	1/2	L1
0.625	5/8	L12
0.750	3/4	L4
1.000		L2
1.500		L7
2.000		L6
2.250		L25
2.500		L16
3.000		L10
3.500		L16
4.000		L11
4.500		L28
5.000		L9
6.000		L3
7.000		L8
8.000		L18
9.000		L45
10.000		L13
11.500		L52
12.000		L4
15.000		L46
18.000		L55
20.000		L5

Harness Type (H)

#28 AWG per MIL-W-16878, 7/34,
 type E Teflon, standard.

Length	All Yellow	Color Coded*
3 (76.2)	H020	H027
6 (152.4)	H019	H016
8 (203.2)	H026	H034
10 (254.0)	H029	H025
12 (304.8)	H028	H002
18 (457.2)	H001	H003
20 (508.0)	H038	H023
24 (609.6)	H009	H004
30 (762.0)	H010	H005
36 (914.4)	H011	H006
48 (1219.2)	H013	H048
72 (1828.8)	H017	H046
120 (3048.0)	H042	H041



Dimensions shown in mm
 Specifications and dimensions subject to

www.ittcannon.com

COTS or Non Mil-Spec or Commercial or Industrial Shell Dimensions (Conforms to Mil-DTL-83513)

Plug

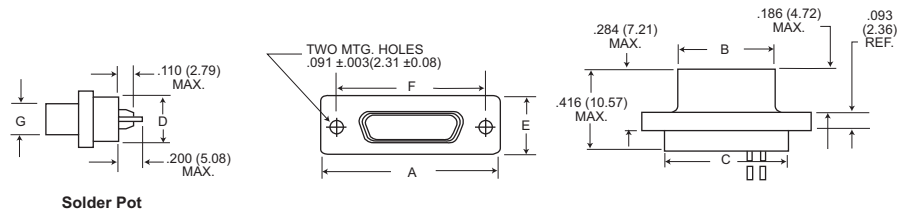

Solder Pot

Receptacle

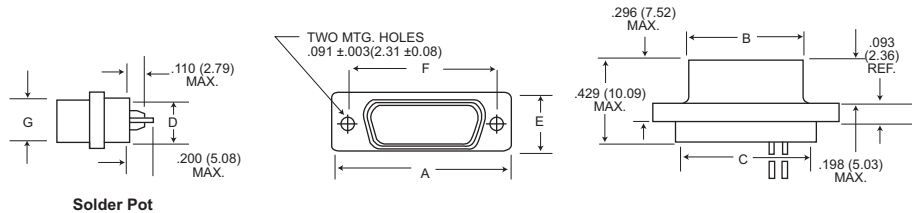

Solder Pot

Receptacle (MDM-100 only)

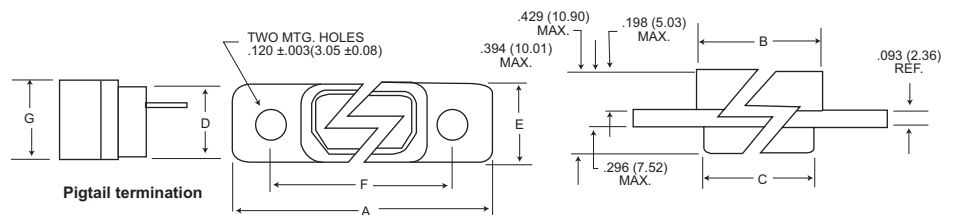
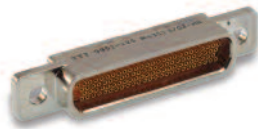

Pigtail termination

Part Number By Shell Size	A Max.	B Max.	C Max.	D Max.	E Max.	F + .005 (0.13)	G Max.	Average Weights** oz. (gm.) ±5%
MDM-9P*	.785 (19.94)	.334 (8.48)	.400 (10.16)	.270 (6.86)	.308 (7.82)	.565 (14.35)	.185 (4.70)	.063 (1.79)
MDM-9S*	.785 (19.94)	.402 (10.21)	.400 (10.16)	.270 (6.86)	.308 (7.82)	.565 (14.35)	.253 (6.43)	.063 (1.79)
MDM-15P*	.935 (23.75)	.484 (12.29)	.550 (13.97)	.270 (6.86)	.308 (7.82)	.715 (18.16)	.185 (4.70)	.084 (2.39)
MDM-15S*	.935 (23.75)	.552 (13.97)	.550 (13.97)	.270 (6.86)	.308 (7.82)	.715 (18.16)	.253 (6.43)	.083 (2.37)
MDM-21P*	1.085 (27.56)	.634 (16.10)	.700 (17.78)	.270 (6.86)	.308 (7.82)	.865 (21.97)	.185 (4.70)	.105 (2.99)
MDM-21P*	1.085 (27.56)	.702 (17.83)	.700 (17.78)	.270 (6.86)	.308 (7.82)	.865 (21.97)	.253 (6.43)	.104 (2.97)
MDM-25P*	1.185 (30.10)	.734 (18.64)	.800 (20.32)	.270 (6.86)	.308 (7.82)	.965 (24.51)	.185 (4.70)	.119 (3.39)
MDM-25S*	1.185 (30.10)	.802 (20.37)	.800 (20.32)	.270 (6.86)	.308 (7.82)	.965 (24.51)	.253 (6.43)	.118 (3.36)
MDM-31P*	1.335 (33.91)	.884 (22.45)	.950 (24.13)	.270 (6.86)	.308 (7.82)	1.115 (28.32)	.185 (4.70)	.140 (3.99)
MDM-31S*	1.335 (33.91)	.952 (24.18)	.950 (24.13)	.270 (6.86)	.308 (7.82)	1.115 (28.32)	.253 (6.43)	.139 (3.96)
MDM-37P*	1.485 (37.72)	1.034 (26.26)	1.100 (27.94)	.270 (6.86)	.308 (7.82)	1.265 (32.13)	.185 (4.70)	.161 (4.59)
MDM-37S*	1.485 (37.72)	1.102 (27.99)	1.100 (27.94)	.270 (6.86)	.308 (7.82)	1.265 (32.13)	.253 (6.43)	.160 (4.56)
MDM-51P*	1.435 (36.45)	.984 (24.99)	1.050 (26.67)	.310 (7.87)	.351 (8.92)	1.215 (30.86)	.228 (5.79)	.193 (5.50)
MDM-51S*	1.435 (36.45)	1.052 (26.72)	1.050 (26.67)	.310 (7.87)	.351 (8.92)	1.215 (30.86)	.296 (7.52)	.188 (5.35)
MDM-100P*	2.170 (55.12)	1.384 (35.15)	1.442 (36.63)	.360 (9.14)	.394 (10.01)	1.800 (45.72)	.271 (6.88)	.500 (14.3)
MDM-100S*	2.170 (55.12)	1.508 (38.10)	1.442 (36.63)	.360 (9.14)	.394 (10.01)	1.800 (45.72)	.394 (10.01)	1.040 (29.5)

*Add lead type and length; see How To Order.

***Weight given is 1/2", insulated, solid, #25 AWG gold plated copper pigtails.

Panel Mounting Dimensions (Sizes 9 - 100)

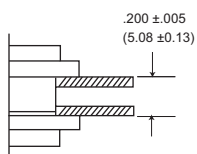

Plug and Receptacle Rear Mounted

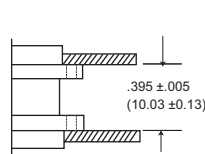

Plug and Receptacle Front Mounted

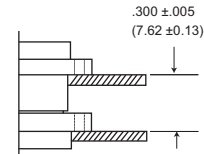

Plug Front Mounted Receptacle Rear Mounted

Dimensions shown in mm
 Specifications and dimensions subject to
www.ittcannon.com



Panel Cutouts

NOTE: See page 13 for rear panel mounting configuration.

Shell Sizes 9 thru 51

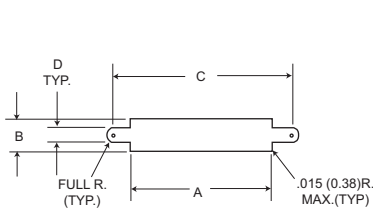

Figure 1
Front Mounting

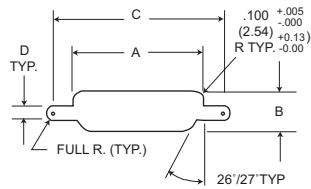

Figure 2
Rear Mounting

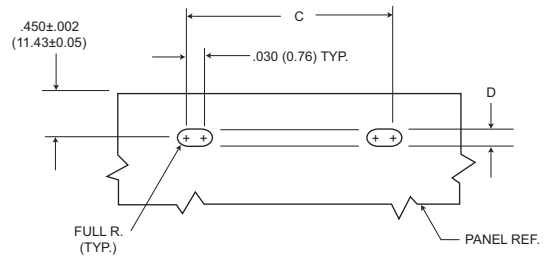

Figure 3
Edgeboard Mounting

Shell Size 100

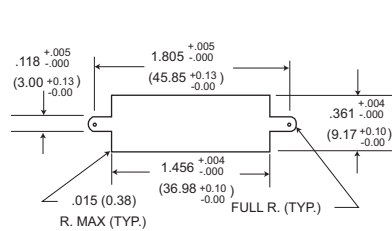

Figure 1
Front Mounting

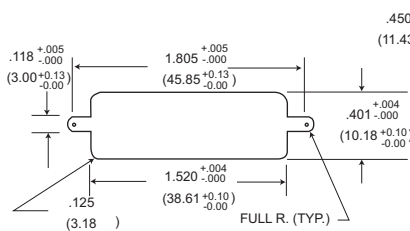

Figure 2
Rear Mounting

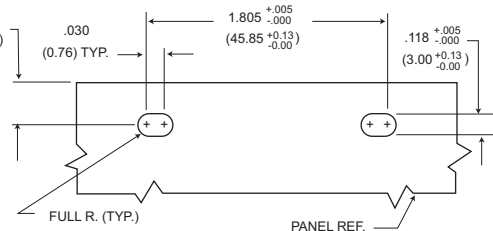

Figure 3
Edgeboard Mounting

For 9-51 Shell Sizes

NOTES:

1. Front panel mounting is the preferred mounting method. Front panel mounting dimensions (figure 1) will accommodate either #2-56 screws or jackpost hardware.
2. Rear panel mount dimensions (figure 2) will accommodate #2-56 screw hardware only. When mounting the connector with rear panel mount jackpost see the panel cut-out dimensions.
3. Edgeboard mounting bracket (figure 3) uses #2-56 screws. Dimension .450+/- .002 (11.43+/- 0.05) locates the MDM receptacle flush with the end of the board.

For 100 Shell Size

NOTES:

1. Front mounting is the preferred mounting method. Front panel mounting dimensions (figure 1) will accommodate either #4-40 screws or jackpost hardware.
2. Rear panel mount dimensions (figure 2) will accommodate #4-40 screw hardware only see the panel cut-out dimensions.
3. Edgeboard mounting bracket (figure 3) uses #4-40 screws. Dimension .450+/- .002 (11.43+/- 0.05) locates the MDM receptacle flush with the end of the board.

Shell Size	Cutout Figure	A +.004 -.000	B +.004 -.000	C +.005 -.000	D +.005 -.000
9	1	.408	.271	.570	.089
	2	.401	.252	.570	.089
	3	-	-	.570	.089
15	1	.558	.271	.720	.089
	2	.551	.252	.720	.089
	3	-	-	.720	.089
21	1	.708	.271	.870	.089
	2	.701	.252	.870	.089
	3	-	-	.870	.089
25	1	.808	.271	.970	.089
	2	.801	.252	.970	.089
	3	-	-	.970	.089
31	1	.958	.271	1.120	.089
	2	.951	.252	1.120	.089
	3	-	-	1.120	.089
37	1	1.108	.271	1.270	.089
	2	1.101	.252	1.270	.089
	3	-	-	1.270	.089
51	1	1.058	.315	1.220	.089
	2	1.051	.295	1.220	.089
	3	-	-	1.220	.089

Cannon Space Connectors

Mounting Hardware Views (for sizes 9-51)

This hardware supplied unassembled.

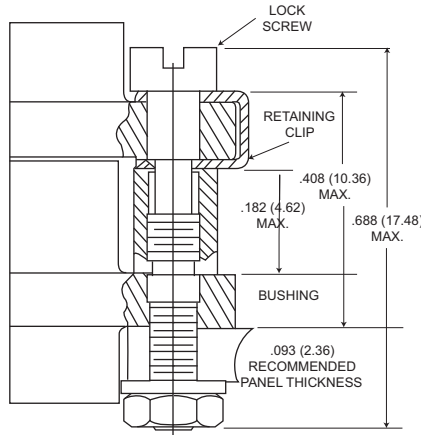
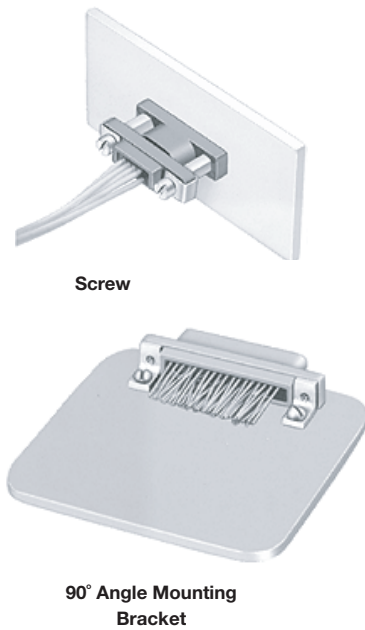

Screw Lock Assembly*
*NOTE Torque value is 2.5 in/lbs max.

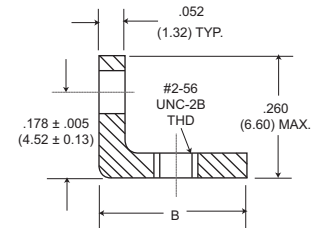
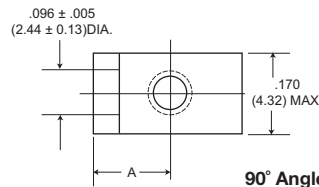
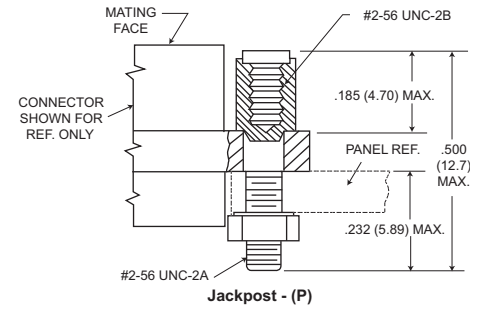

90° Angle Mounting Bracket

Description	Part Number	A +/- .005 (±0.13)	B Max.
Screw	322-9500-000		N/A
Jackpost kit	320-9505-000		N/A
Mounting Bracket 90° MDM for 9 thru 37 Shell Sizes	015-9516-002	.147 (3.73)	.308 (7.82)
Mounting Bracket 90° MDM for 51 Shell Size	015-9516-003	.169 (4.29)	.350 (8.89)

NOTES: Screw lock assembly (322-9500-000) can be used for front mounting only. Jackpost kit (320-9505-000) consists of two assemblies, shipped unassembled.

Jackpost Bushing (for rear panel mounting-for sizes 9-51)

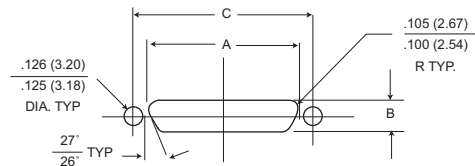
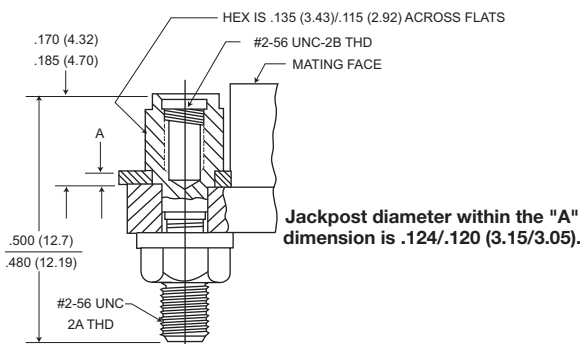

Plug and Receptacle Dimensions

Shell Size	A +.004 (0.10) -.000 (0.00)	B +.004 (0.10) -.000 (0.00)	C ±.005 (0.13)
9	.401 (10.19)	.252 (6.40)	.565 (14.35)
15	.551 (14.00)	.252 (6.40)	.715 (18.16)
21	.701 (17.81)	.252 (6.40)	.865 (21.97)
25	.801 (20.34)	.252 (6.40)	.965 (24.51)
31	.951 (24.16)	.252 (6.40)	1.115 (28.34)
37	1.101 (27.97)	.252 (6.40)	1.265 (32.13)
51	1.051 (26.70)	.295 (7.49)	1.215 (30.86)

Panel A Thickness	A +.005 (0.13) -.000 (0.00)	Jackpost Kit Number*
3/32 (2.4)	.087 (2.21)	320-9505-007
1/16 (1.6)	.056 (1.42)	320-9505-006
3/64 (1.2)	.042 (1.07)	320-9505-005
1/32 (0.8)	.025 (0.64)	320-9505-004

*A kit consists of 2 jackpost, 2 nuts, 2 washers.

Dimensions shown in mm
Specifications and dimensions subject to
www.ittcannon.com



Mounting Hardware Views (for sizes 9-51)

This hardware

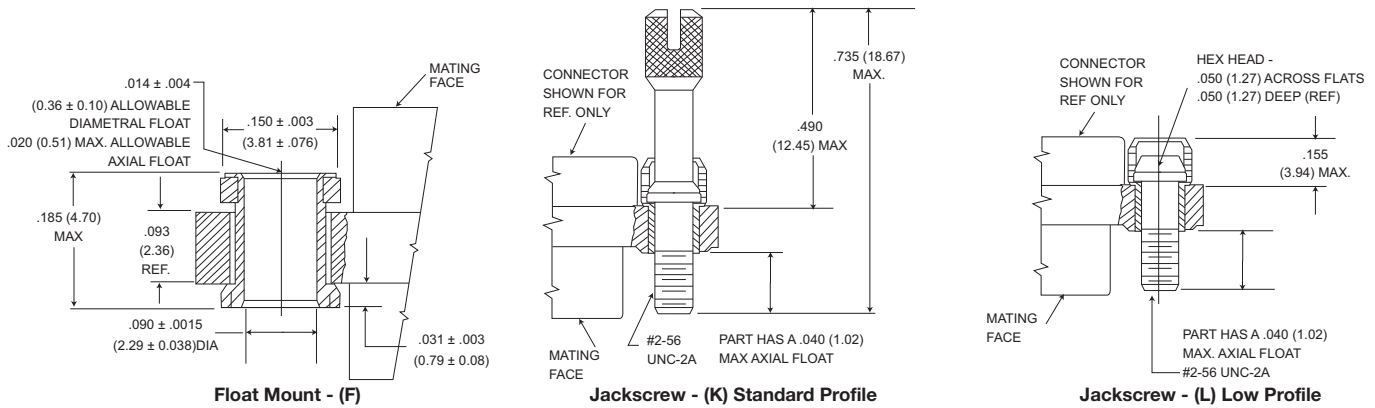

Shown here is a cutaway view of the float mount for the MDM connector. The basic shell dimensions are the same for the float mount and the screw mounting hole configurations. View shown is for standard float mount front panel mounting. Reverse mounting is available on request.

* NOTE: Torque values are as follows:
 Low Profile Jackscrew (L)-2.5 in-lbs
 Standard Jackscrew (K)-2.5 in-lbs

Mounting Hardware to Military Specification (for sizes 9 - 100) per MIL-DTL-83513/5

This hardware supplied in kits unassembled (2 pieces of each item).

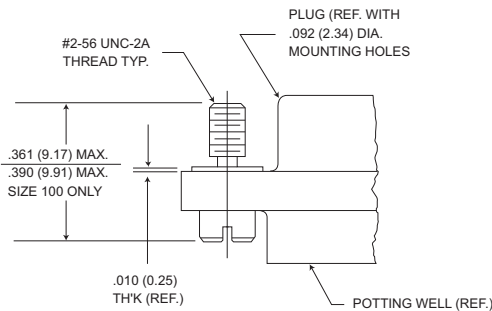
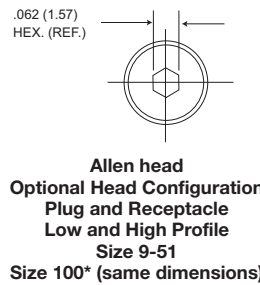

Figure 1. Jackscrew - Low profile Slotted Head
 Size 9-51
 Size 100*



Allen head Optional Head Configuration Plug and Receptacle Low and High Profile
 Size 9-51
 Size 100* (same dimensions)

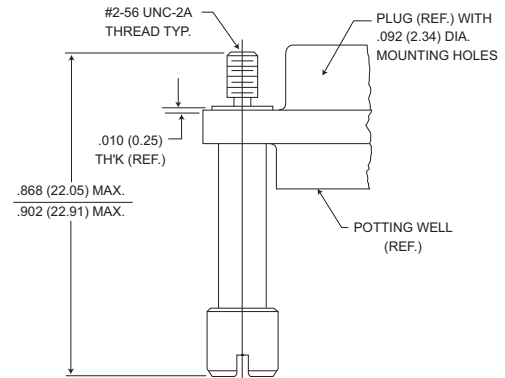

Figure 2. Jackscrew - High Profile Slotted Head
 Size 9-51
 Size 100*

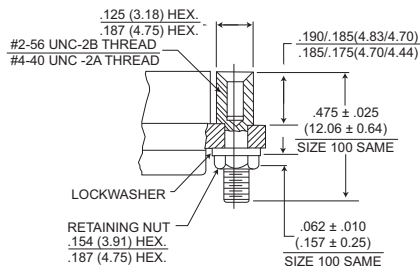

Figure 3. Jackpost Assembly
 Size 9-51
 Size 100*

To order hardware kits separately, order either by M83513/5-** or by 320-950X-XXX.

Description	Size 9-51		Size 100*	
	Mod Code	Part Number	Mod Code	Part Number
Slotted Head Jackscrew Assy Low Profile (Figure 1)	M5	320-9508-025	05	M15 320-9508-021
Slotted Head Jackscrew Assy Low Profile (Figure 2)	M6	320-9508-027	06	M16 320-9508-023
Allen Head Jackscrew Assy Low Profile (Figure 1)	M2	320-9508-026	02	M12 320-9508-022
Allen Head Jackscrew Assy High Profile (Figure 2)	M3	320-9508-028	03	M13 320-9508-024
Jackpost Assy (Figure 3)	M7	320-9505-033	07	M17 320-9505-030

*Size 100 requires B1 size mounting holes for Mil-Spec hardware

Note: Torque values as follows:

Size 9-51 4.0 in-lbs

Size 100 6.0 in-lbs



Mounting Hardware Views (for size 100)

This hardware



90° Angle Mounting Bracket

Note: Size 100 requires .120 dia (B) mounting hole when using Commercial (P) jackpost kits.

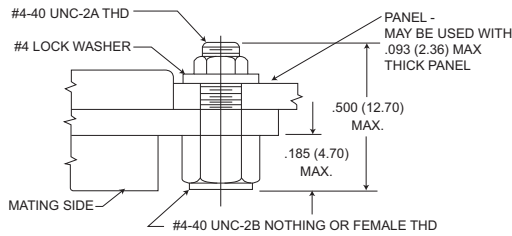

Jackpost - (P)

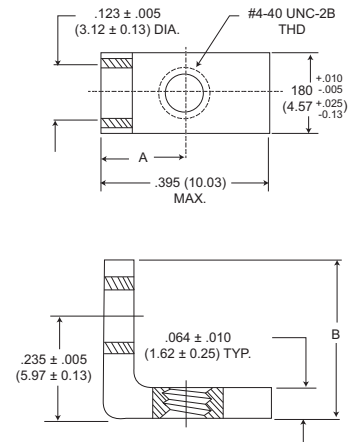

90° Angle Mounting Bracket

Description	Part Number	A ± .005 (0.13)	B Max.
Jackpost kit	320-9505-015		N/A
Mounting Bracket 90° MDM	015-9528-000	.191 (4.85)	.370 (9.40)

This hardware is factory installed.

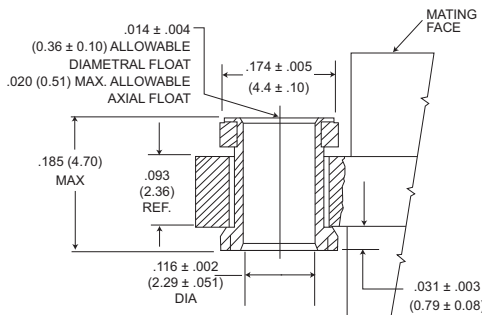

Float Mount - (F) Std.

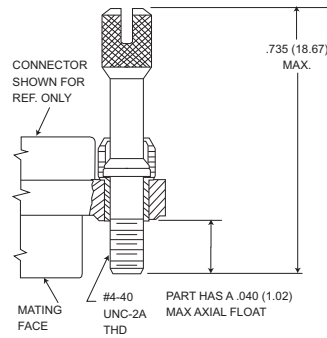

Jackscrew - (K) Standard

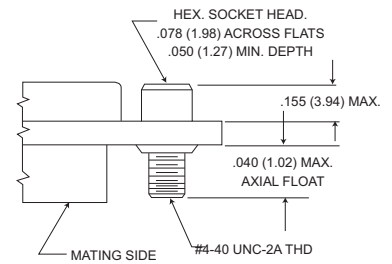

Jackscrew - (L) (Low Profile)

*NOTE: Torque values are as follows:
Low Profile Jackscrew (L)-4.0 in-lbs
Standard Profile Jackscrew (K)-4.0 in-lbs

Jackpost Bushing (for Rear Panel Mounting)

Panel Thickness	A +.005 (0.13) -.000 (0.00)	Jackpost Kit Number*
3/32 (2.4)	.087 (2.21)	320-9505-013
1/16 (1.6)	.058 (1.42)	320-9505-012
1/32 (0.8)	.025 (0.64)	320-9505-010
3/64 (1.2)	.042 (1.07)	320-9505-011

*2 jackposts, 2 nuts, 2 washers

Torque value for size 100

Note: Size 100 requires B mounting hole shell size when using rear panel mount jackposts

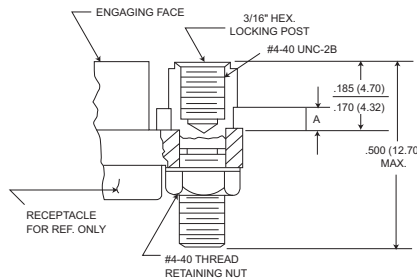

Dimensions for Rear Panel Mounting

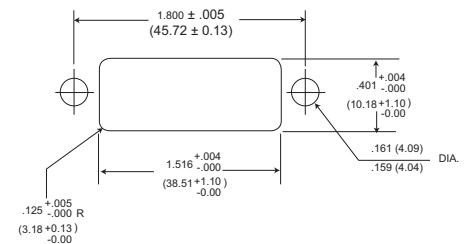

Dimensions shown in mm

Specifications and dimensions subject to

www.ittcannon.com



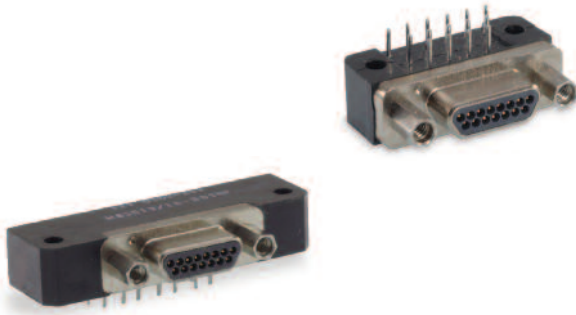

MDM-PCB connectors are designed for use with flex circuitry, flat cable and printed circuit boards or multi-layer boards. They use the standard MDM metal shell and provide high density and high reliability in board-to-board, board-to-cable and cable-to-cable applications.

MDM-PCB connectors are available in 8 shell sizes with 9 to 100 contacts. Terminations may be straight (BS) or at 90° right angle (BR, CBR) board thickness. Jackpost mounting for use with locking hardware is also available.

How to Order - MDM-PCB Series

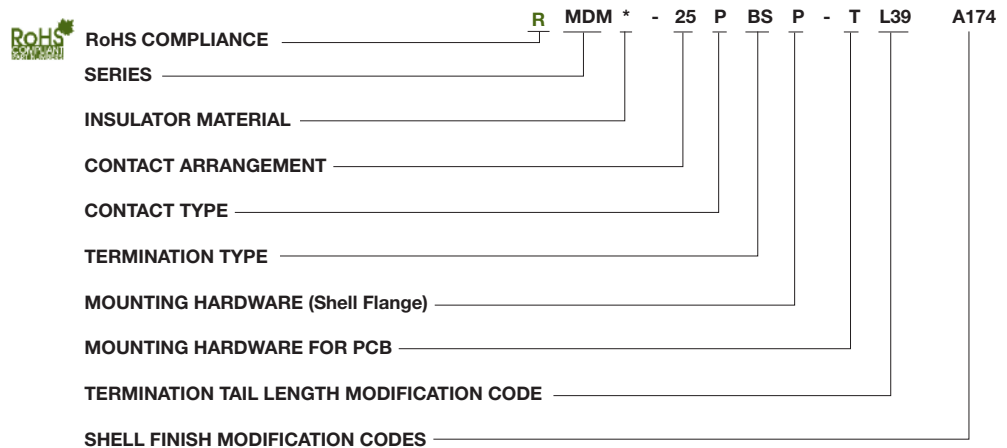

SERIES

MDM - Micro "D" Metal Shell

INSULATOR MATERIAL

Liquid Crystal Polymer (LCP)

CONTACT ARRANGEMENT

9, 15, 21, 25, 31, 37, 51, and 100

CONTACT TYPE

P - Pin (Plug)
S - Socket (Receptacle)

TERMINATION TYPE

BS - Straight PCB Termination
BR - Right Angle PCB Termination
CBR - Right Angle Narrow Profile PCB Terminations

MOUNTING HARDWARE (Shell Flange)

P - Jackposts
M7 - Jackposts
M83513/5-07 (Sizes 9-51)
M17 - Jackposts
M83513/5-17 (Size 100)
No letter - none

MOUNTING HARDWARE FOR PCB

T - Threaded Insert
#2-56 Thd for Shell Sizes 9 thru 51
#4-40 Thd for Shell Size 100
No letter - none

TERMINATION TAIL LENGTH MODIFICATION CODE

None - .109 (2.77) ±.015 (0.38) Standard
L61 - .125 (3.18)
L56 - .150 (3.81)
L57 - .190 (4.83)
L39 - .250 (6.35)
L58 - .375 (9.52)

SHELL FINISH MODIFICATION CODES

None - Yellow Chromate/Cadmium over Nickel
A174 - Electroless Nickel
A172 - Gold over Nickel

(For special modification codes, consult customer service.)

NOTE: Back molding material – Epoxy Hysol #MG40FS

BS (Board Straight) Series

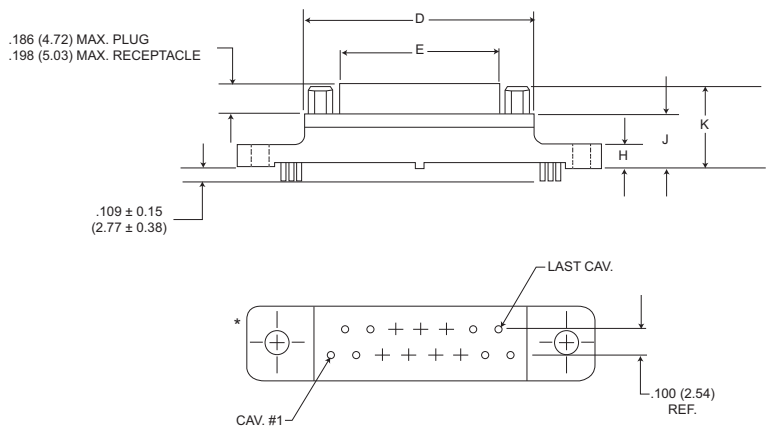
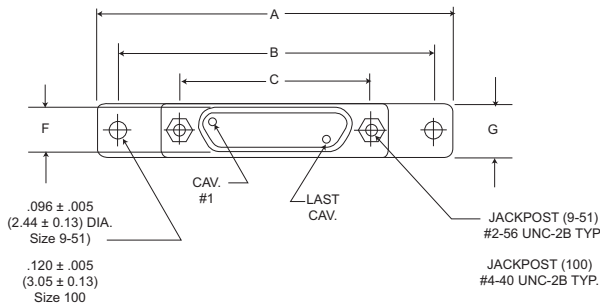

PCB Termination Arrangements* (Viewed from PCB solder side)

Identification number shown for plug connector, use reverse order for socket connector.

NOTE: Dimensions shown are for reference only-consult factory for final design dimensions.

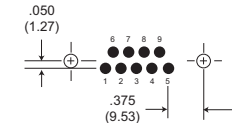

9 Contacts

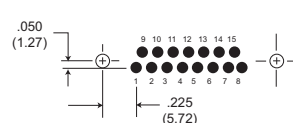

15 Contacts

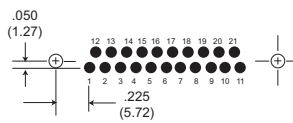

21 Contacts

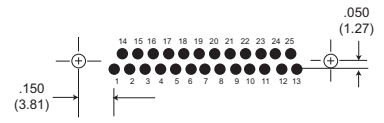

25 Contacts

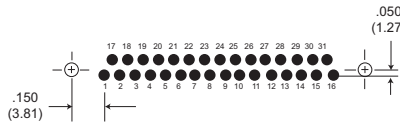

31 Contacts

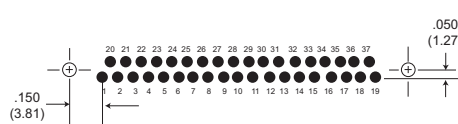

37 Contacts

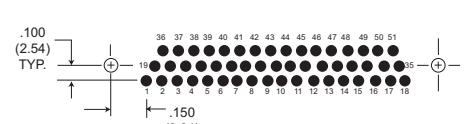

51 Contacts

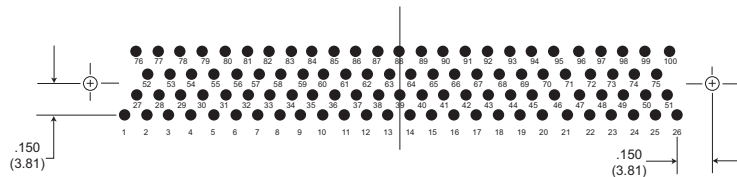

100 Contacts

NOTE: Standard lead termination is #24 AWG, solid copper, solder or tin dipped

All Termination Configurations .100 (2.54) x .100 (2.54) Grid Pattern, Offset .050 (1.27)

Part Number By Shell Size	A	B	C	D	E	F	G	H	J	K
	Max.	±.007 (.18)	±.005 (.13)	Max.	Max.	Max.	Max.	Max.	Max.	Max.
MDM-9PBS*	1.390 (35.31)	1.150 (29.21)	.565 (14.35)	.785 (19.94)	.334 (8.48)	.185 (4.70)	.308 (7.82)	.165 (4.19)	.355 (9.02)	.555 (14.10)
MDM-9SBS*	1.390 (35.31)	1.150 (29.21)	.565 (14.35)	.785 (19.94)	.402 (10.21)	.253 (6.43)	.308 (7.82)	.165 (4.19)	.355 (9.02)	.555 (14.10)
MDM-15PBS*	1.390 (35.31)	1.150 (29.21)	.715 (18.16)	.935 (23.75)	.484 (12.29)	.185 (4.70)	.308 (7.82)	.165 (4.19)	.355 (9.02)	.555 (14.10)
MDM-15SBS*	1.390 (35.31)	1.150 (29.21)	.715 (18.16)	.935 (23.75)	.552 (13.97)	.253 (6.43)	.308 (7.82)	.165 (4.19)	.355 (9.02)	.555 (14.10)
MDM-21PBS*	1.690 (43.93)	1.450 (36.83)	.865 (21.97)	1.085 (27.56)	.634 (16.10)	.185 (4.70)	.308 (7.82)	.165 (4.19)	.355 (9.02)	.555 (14.10)
MDM-21SBS*	1.690 (43.93)	1.450 (36.83)	.865 (21.97)	1.085 (27.56)	.702 (17.83)	.253 (6.43)	.308 (7.82)	.165 (4.19)	.355 (9.02)	.555 (14.10)
MDM-25PBS	1.740 (44.20)	1.500 (38.10)	.965 (24.51)	1.185 (30.10)	.734 (18.64)	.185 (4.70)	.308 (7.82)	.165 (4.19)	.355 (9.02)	.555 (14.10)
MDM-25SBS*	1.740 (44.20)	1.500 (38.10)	.965 (24.51)	1.185 (30.10)	.802 (20.37)	.253 (6.43)	.308 (7.82)	.165 (4.19)	.355 (9.02)	.555 (14.10)
MDM-31PBS*	2.040 (51.82)	1.800 (45.72)	1.115 (28.32)	1.335 (33.91)	.884 (22.45)	.185 (4.70)	.308 (7.82)	.165 (4.19)	.355 (9.02)	.555 (14.10)
MDM-31SBS*	2.040 (51.82)	1.800 (45.72)	1.115 (28.32)	1.335 (33.91)	.952 (24.18)	.253 (6.43)	.308 (7.82)	.165 (4.19)	.355 (9.02)	.555 (14.10)
MDM-37PBS*	2.340 (59.44)	2.100 (53.34)	1.265 (32.13)	1.485 (37.72)	1.034 (26.26)	.185 (4.70)	.308 (7.82)	.165 (4.19)	.355 (9.02)	.555 (14.10)
MDM-37SBS*	2.340 (59.44)	2.100 (53.34)	1.265 (32.13)	1.485 (37.72)	1.102 (27.99)	.253 (6.43)	.308 (7.82)	.165 (4.19)	.355 (9.02)	.555 (14.10)
MDM-51PBS*	2.270 (67.66)	2.000 (50.80)	1.215 (30.86)	1.435 (36.45)	.984 (24.99)	.228 (5.79)	.351 (8.92)	.165 (4.19)	.355 (9.02)	.555 (14.10)
MDM-51SBS*	2.270 (67.66)	2.000 (50.80)	1.215 (30.86)	1.435 (36.45)	1.052 (26.72)	.296 (7.52)	.351 (8.92)	.165 (4.19)	.355 (9.02)	.555 (14.10)
MDM-100PBS*	3.070 (77.98)	2.800 (71.12)	1.800 (45.72)	2.175 (55.24)	1.384 (35.15)	.271 (6.88)	.460 (11.68)	.303 (7.70)	.550 (12.70)	.686 (17.42)
MDM-100SBS*	3.070 (77.98)	2.800 (71.12)	1.800 (45.72)	2.175 (55.24)	1.508 (38.30)	.394 (10.01)	.460 (11.68)	.303 (7.70)	.550 (12.70)	.686 (17.75)

*For jackpost, add letter "P" or "M7" for sizes 9-51, "M17" for size 100.

Dimensions shown in mm
Specifications and dimensions subject to

www.ittcannon.com



BR (Board Right Angle) Series

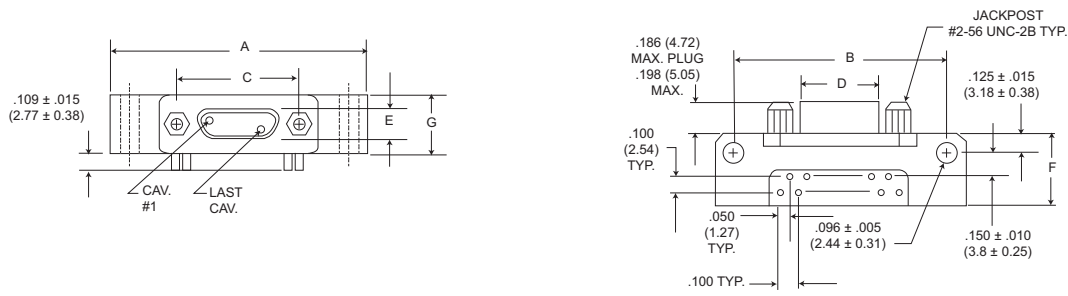

PCB Termination Arrangements (Viewed from bottom of connector, PCB solder side.)

Identification number shown for plug connector, use reverse order for socket connector.

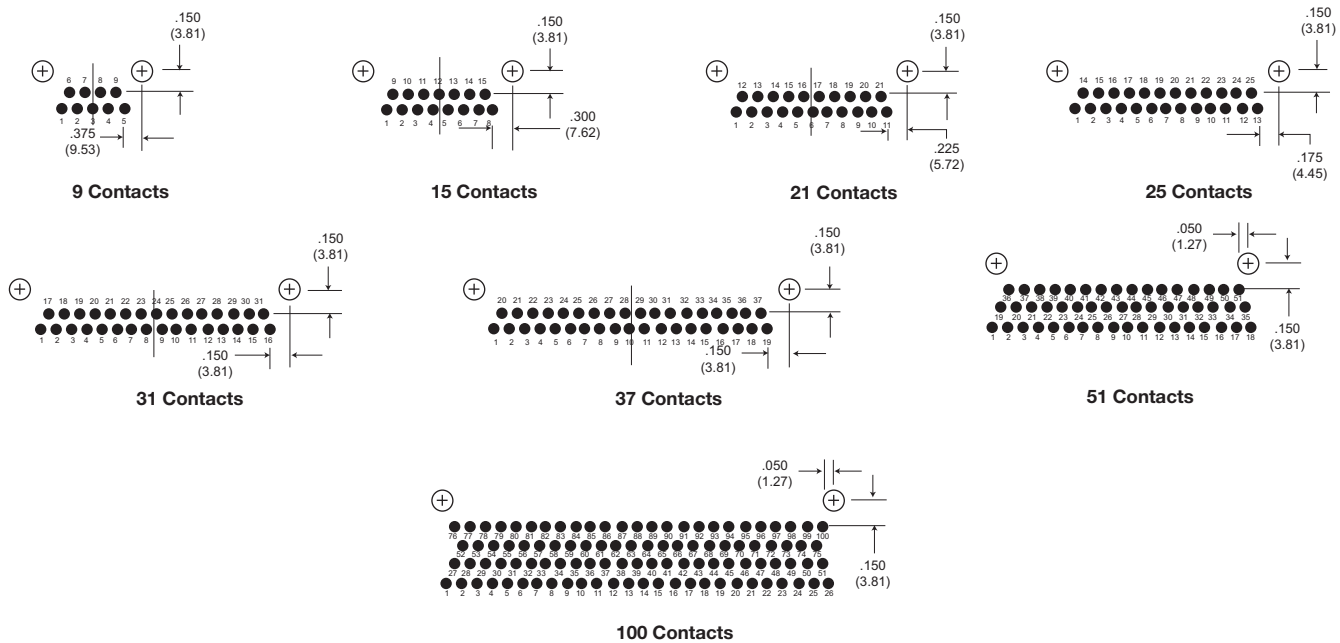

NOTE: Standard lead termination is #24 AWG, gold plated, solid copper, solder or tin dripped.

All Termination Configurations .100 (2.54) x .100 (2.54) Grid Pattern, Offset .050 (1.27).

Part Number By Shell Size	A Max.	B ± .007 (.18)	C ± .005 (.13)	D Max.	E Max.	F Max.	G Max.
MDM-9PBR*	1.390 (35.31)	1.150 (29.21)	.565 (14.35)	.334 (8.48)	.185 (4.70)	.455 (11.56)	.308 (7.82)
MDM-9SBR*	1.390 (35.31)	1.150 (29.21)	.565 (14.35)	.402 (10.21)	.253 (6.43)	.455 (11.56)	.308 (7.82)
MDM-15PBR*	1.540 (39.12)	1.300 (33.02)	.715 (18.16)	.484 (12.29)	.185 (4.70)	.455 (11.56)	.308 (7.82)
MDM-15SBR*	1.540 (39.12)	1.300 (33.02)	.715 (18.16)	.552 (13.97)	.253 (6.43)	.455 (11.56)	.308 (7.82)
MDM-21PBR*	1.690 (42.93)	1.450 (36.83)	.865 (21.97)	.634 (16.10)	.185 (4.70)	.455 (11.56)	.308 (7.82)
MDM-21SBR*	1.690 (42.93)	1.450 (36.83)	.865 (21.97)	.702 (17.83)	.253 (6.43)	.455 (11.56)	.308 (7.82)
MDM-25PBR*	1.790 (45.47)	1.550 (39.37)	.965 (24.51)	.734 (18.64)	.185 (4.70)	.455 (11.56)	.308 (7.82)
MDM-25SBR*	1.790 (45.47)	1.550 (39.37)	.965 (24.51)	.802 (20.37)	.253 (6.43)	.455 (11.56)	.308 (7.82)
MDM-31PBR*	2.040 (51.82)	1.800 (45.72)	1.115 (28.32)	.884 (22.45)	.185 (4.70)	.455 (11.56)	.308 (7.82)
MDM-31SBR*	2.040 (51.82)	1.800 (45.72)	1.115 (28.32)	.952 (24.18)	.253 (6.43)	.455 (11.56)	.308 (7.82)
MDM-37PBR*	2.340 (59.44)	2.100 (53.34)	1.265 (32.13)	1.034 (26.26)	.185 (4.70)	.455 (11.56)	.308 (7.82)
MDM-37SBR*	2.340 (59.44)	2.100 (53.34)	1.265 (32.13)	1.102 (27.99)	.253 (6.43)	.455 (11.56)	.308 (7.82)
MDM-51PBR*	1.875 (47.63)	1.600 (40.64)	1.215 (30.86)	.984 (24.99)	.228 (5.79)	.565 (14.35)	.351 (8.92)
MDM-51SBR*	1.875 (47.63)	1.600 (40.64)	1.215 (30.86)	1.052 (26.72)	.296 (7.52)	.565 (14.35)	.351 (8.92)
MDM-100PBR*	2.74 (69.72)	2.500 (63.50)	1.800 (45.72)	1.384 (35.15)	.271 (6.88)	.755 (19.18)	.394 (10.01)
MDM-100SBR*	2.74 (69.72)	2.500 (63.50)	1.800 (45.72)	1.508 (38.10)	.394 (10.01)	.755 (19.18)	.394 (10.01)

*For jackpost, add letter "P" or "M7" for sizes 9-51, "M17" for size 100.



Dimensions shown in mm
Specifications and dimensions subject to

www.ittcannon.com

CBR (Condensed Board Right Angle) Series

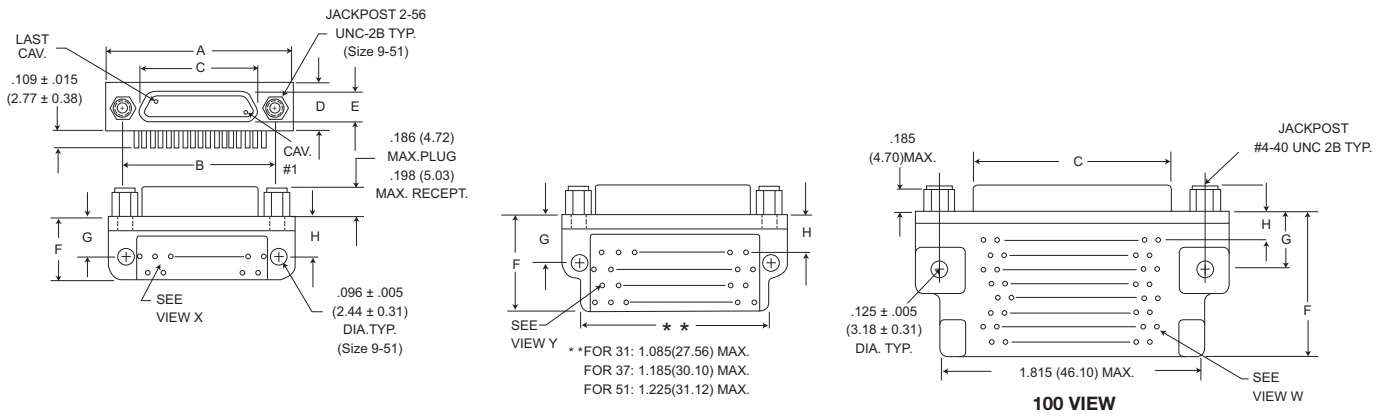

PCB Termination Arrangements (Viewed from bottom of connector, PCB solder side.)

Identification number shown for plug connector, use reverse order for socket connector.

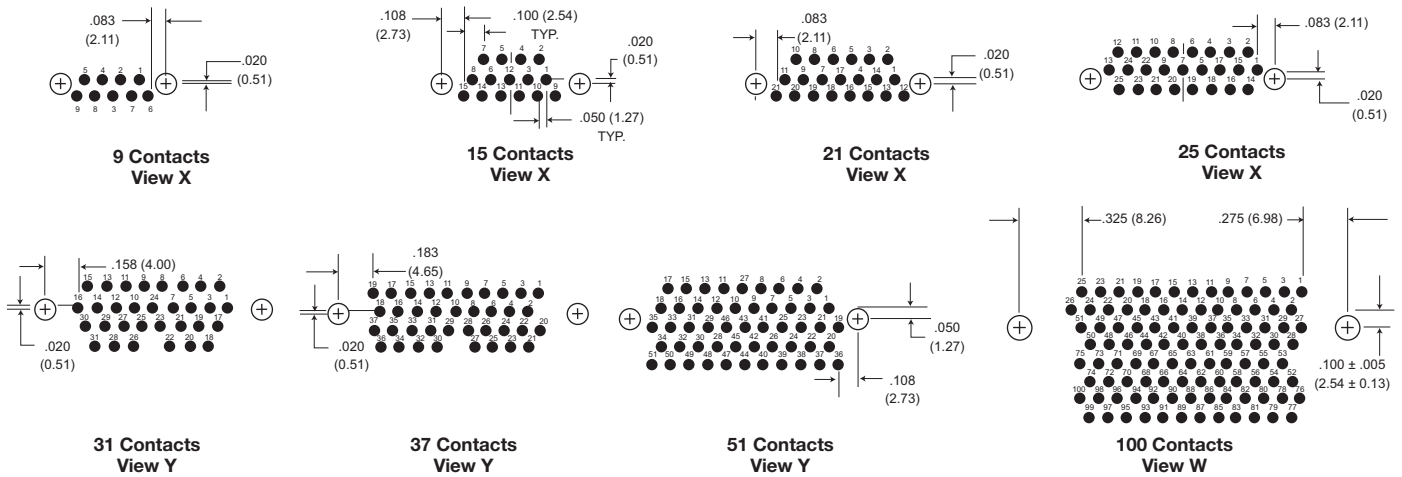

All Termination Configurations .100 (2.54) x .100 (2.54) Grid Pattern, Offset .050 (1.27).

NOTE: Standard lead termination is #24 AWG, solid copper, solder or tin dripped.

Part Number By Shell Size	A Max.	B ± .005 (.13)	C Max.	D Max.	E Max.	F Max.	G ± .010 (.25)	H ± .010 (.25)
MDM-9PCBR*	.785 (19.94)	.565 (14.35)	.334 (8.48)	.308 (7.82)	.185 (4.70)	.420 (10.67)	.250 (6.35)	.230 (5.81)
MDM-9SCBR*	.785 (19.94)	.565 (14.35)	.402 (10.21)	.308 (7.82)	.253 (6.43)	.420 (10.67)	.250 (6.35)	.230 (5.81)
MDM-15PCBR*	.935 (23.75)	.715 (18.16)	.484 (12.29)	.308 (7.82)	.185 (4.70)	.420 (10.67)	.250 (6.35)	.130 (3.30)
MDM-15SCBR*	.935 (23.75)	.715 (18.16)	.552 (13.97)	.308 (7.82)	.253 (6.43)	.420 (10.67)	.250 (6.35)	.130 (3.30)
MDM-21PCBR*	1.085 (27.56)	.865 (21.97)	.634 (16.10)	.308 (7.82)	.185 (4.70)	.420 (10.67)	.250 (6.35)	.130 (3.30)
MDM-21SCBR*	1.085 (27.56)	.865 (21.97)	.702 (17.83)	.308 (7.82)	.253 (6.43)	.420 (10.67)	.250 (6.35)	.130 (3.30)
MDM-25PCBR*	1.185 (30.10)	.965 (24.51)	.734 (18.64)	.308 (7.82)	.184 (4.70)	.420 (10.67)	.250 (6.35)	.130 (3.30)
MDM-25SCBR*	1.185 (30.10)	.965 (24.51)	.802 (20.37)	.308 (7.82)	.253 (6.43)	.420 (10.67)	.250 (6.35)	.130 (3.30)
MDM-31PCBR*	1.335 (33.91)	1.115 (28.32)	.884 (22.45)	.308 (7.82)	.185 (4.70)	.520 (13.21)	.250 (6.35)	.130 (3.30)
MDM-31SCBR*	1.335 (33.91)	1.115 (28.32)	.952 (24.18)	.308 (7.82)	.253 (6.43)	.520 (13.21)	.250 (6.35)	.130 (3.30)
MDM-37PCBR*	1.485 (37.72)	1.265 (32.13)	1.034 (26.26)	.308 (7.82)	.185 (4.70)	.520 (13.21)	.250 (6.35)	.130 (3.30)
MDM-37SCBR*	1.485 (37.72)	1.265 (32.13)	1.102 (27.99)	.308 (7.82)	.253 (6.43)	.520 (13.21)	.250 (6.35)	.130 (3.30)
MDM-51PCBR*	1.435 (36.45)	1.215 (30.86)	.984 (24.99)	.351 (8.92)	.228 (5.79)	.650 (16.15)	.300 (7.62)	.150 (3.81)
MDM-51SCBR*	1.435 (36.45)	1.215 (30.86)	1.052 (26.72)	.351 (8.92)	.296 (7.52)	.650 (16.15)	.300 (7.62)	.150 (3.81)
MDM-100PCBR*	2.170 (55.12)	1.800 (45.72)	1.384 (35.15)	.394 (10.01)	.271 (6.88)	1.000 (25.40)	.400 (10.16)	.200 (5.08)
MDM-100SCBR*	2.170 (55.12)	1.800 (45.72)	1.508 (38.10)	.394 (10.01)	.394 (10.01)	1.000 (25.40)	.400 (10.16)	.200 (5.08)

*For jackpost, add letter "P" or "M7" for sizes 9-51, "M17" for size 100.

Connector Modification Type F226 (ESA Code FR136) Shell Sizes 9 to 37

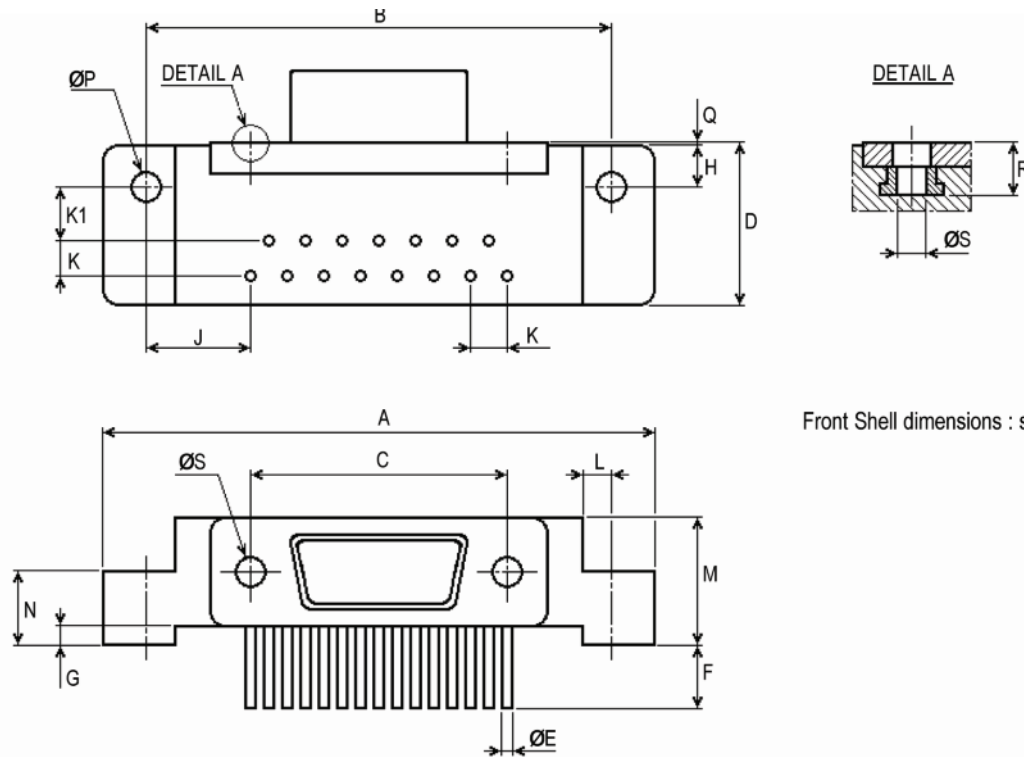

Front Shell dimensions : see page 7

Shell Size		9	15	21	25	31	37
A	max.	35,31 (1.390)	39,12 (1.540)	42,93 (1.690)	45,47 (1.790)	51,82 (2.040)	59,44 (2.340)
B	± 0,18 (.007)	29,21 (1.150)	33,02 (1.300)	36,83 (1.450)	39,37 (1.550)	45,72 (1.800)	53,34 (2.100)
C	± 0,13 (.005)	14,35 (.565)	18,16 (.715)	21,97 (.865)	24,51 (.965)	28,32 (1.115)	32,13 (1.265)
D	max.	11,56 (.455)	11,56 (.455)	11,56 (.455)	11,56 (.455)	11,56 (.455)	11,56 (.455)
ØE	max.	0,46 (.018)	0,46 (.018)	0,46 (.018)	0,46 (.018)	0,46 (.018)	0,46 (.018)
F	± 0,35 (.014)	4,50 (.177)	4,50 (.177)	4,50 (.177)	4,50 (.177)	4,50 (.177)	4,50 (.177)
G	± 0,20 (.008)	1,50 (.059)	1,50 (.059)	1,50 (.059)	1,50 (.059)	1,50 (.059)	1,50 (.059)
H	± 0,38 (.015)	3,17 (.125)	3,17 (.125)	3,17 (.125)	3,17 (.125)	3,17 (.125)	3,17 (.125)
J	Typ.	9,53 (.375)	7,62 (.300)	5,72 (.225)	4,45 (.175)	3,81 (.150)	3,81 (.150)
K	Typ.	2,54 (.100)	2,54 (.100)	2,54 (.100)	2,54 (.100)	2,54 (.100)	2,54 (.100)
K1	± 0,25 (.010)	3,81 (.150)	3,81 (.150)	3,81 (.150)	3,81 (.150)	3,81 (.150)	3,81 (.150)
L	± 0,05 (.002)	2,05 (.081)	2,05 (.081)	2,05 (.081)	2,05 (.081)	2,05 (.081)	2,05 (.081)
M	± 0,10 (.004)	9,10 (.358)	9,10 (.358)	9,10 (.358)	9,10 (.358)	9,10 (.358)	9,10 (.358)
N	± 0,15 (.006)	5,30 (.209)	5,30 (.209)	5,30 (.209)	5,30 (.209)	5,30 (.209)	5,30 (.209)
ØP (*)	± 0,15 (.006)	2,45 (.096)	2,45 (.096)	2,45 (.096)	2,45 (.096)	2,45 (.096)	2,45 (.096)
Q	± 0,10 (.004)	0,30 (.012)	0,30 (.012)	0,30 (.012)	0,30 (.012)	0,30 (.012)	0,30 (.012)
R	min.	4,60 (.181)	4,60 (.181)	4,60 (.181)	4,60 (.181)	4,60 (.181)	4,60 (.181)
ØS	Typ	2-56-UNC-2B	2-56-UNC-2B	2-56-UNC-2B	2-56-UNC-2B	2-56-UNC-2B	2-56-UNC-2B

Note (*) : Maximum torque 0.44 Nm.



Connector Modification Type F226 (ESA Code FR136) Shell Size 51

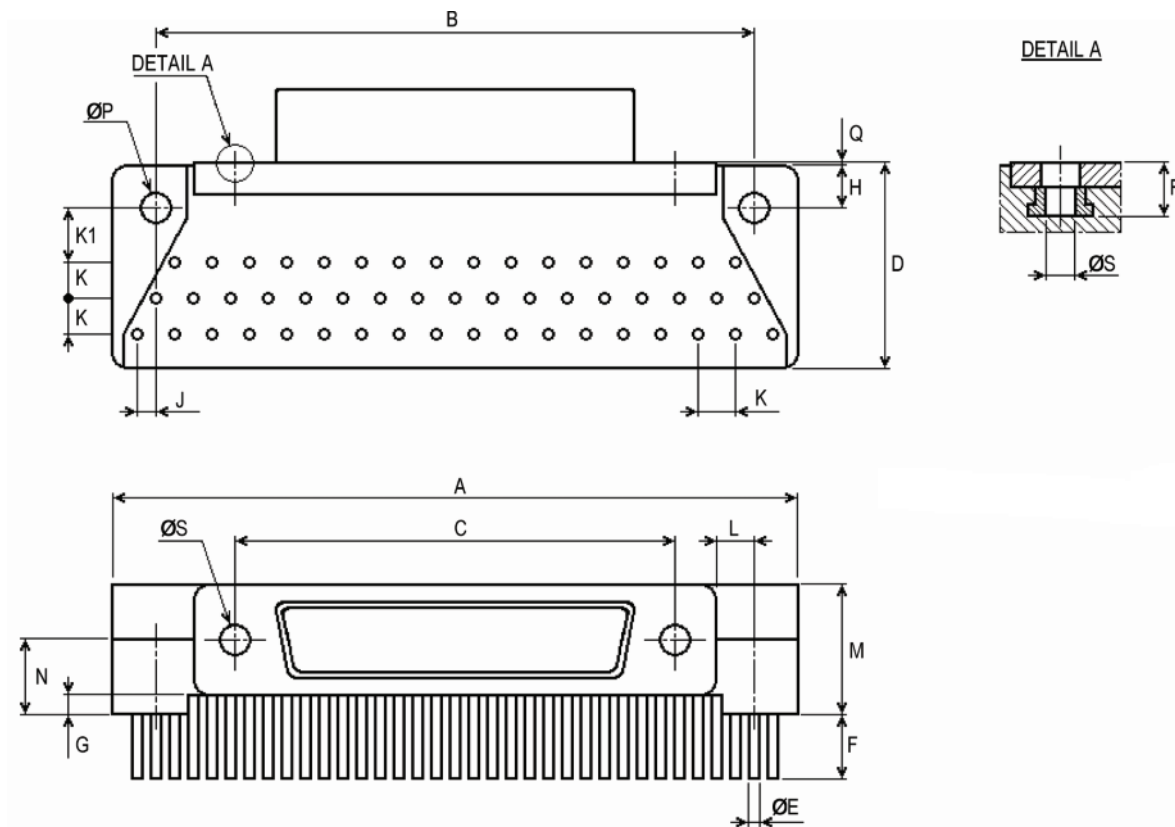

Shell Size		51
A	max.	47,63 (1.875)
B	± 0,18 (.007)	40,64 (1.600)
C	± 0,13 (.005)	30,86 (1.215)
D	max.	14,35 (.565)
ØE	max.	0,46 (.018)
F	± 0,35 (.014)	4,50 (.177)
G	± 0,20 (.008)	1,50 (.059)
H	± 0,38 (.015)	3,17 (.125)
J	Typ.	1,27 (.050)
K	Typ.	2,54 (.100)
K1	± 0,25 (.010)	3,81 (.150)
L	± 0,05 (.002)	2,05 (.081)
M	± 0,10 (.004)	10,25 (.404)
N	± 0,15 (.006)	5,96 (.235)
ØP (*)	± 0,15 (.006)	2,45 (.096)
Q	± 0,10 (.004)	0,30 (.012)
R	min.	4,60 (.181)
ØS	Typ.	2-56-UNC-2B

ote (*) : Maximum torque 0.44 Nm.

Cannon Space Connectors

MDM Coax and Power

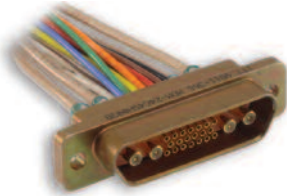

MDM Coaxial

The MDM Metal Shell Connectors have been tooled in several coaxial layouts and offer the versatility of combining coaxial and signal lines in the same connector. Any modifications to these layouts or new requirements, please consult the factory. Standard coax is RG178 white.

MDM Power

The same insulator that is used with coaxial contacts is available with power contacts. This offers the versatility of combining power and signal lines in the same connector.

MDM Coaxial/Power

Power and coaxial contacts can be interchanged as desired. Power contacts are rated at 13 amps, 24V rms, AWG #16 stranded.

How to Order

For MIL-DTL-83513 ordering information see pages 16 and 17

SERIES

MDM: (Size 9-100) Liquid Crystal Polymer (LCP)
MDM: (Combo Layout) Diallyl Phthalate (DAP)

CONTACT ARRANGEMENTS

9-15-21-25-31-37-51-100 (standard)
16C5, 10C10, 7C2, 24C4 (coaxial)
16P5, 10P10, 7P2, 24P4 (power)

} or combination of
coax and power

CONTACT TYPE

P - Pin S - Socket

TERMINATION TYPE

H - Harness-insulated wire.
L - Solid-uninsulated wire.
S - Solder pot to accept #26 AWG MAX. harness wire. (Not available with power contact arrangements.)

HARDWARE

M - Military specification hardware, see page 11 for military hardware codes.
P - Jackpost
K - Jackscrew-standard profile
L - Jackscrew-low profile



RoHS COMPLIANT

SERIES

CONTACT ARRANGEMENTS

CONTACT TYPE

TERMINATION TYPE

TERMINATION CODE

HARDWARE

SHELL FINISH MOD CODES

F - Float mount
B - No hardware standard
.091 (2.31) dia. hole for sizes 9-51;
.120 (3.05) dia. hole for size 100.
A - .125 (3.18) dia. mounting holes for sizes 9-51;
.166 (4.22) dia. hole for size 100.
B1 - .1475 (3.75) dia. hole for size 100
(Per MIL-DTL-83513)

TERMINATION CODE*

(H) 001 - 18", 7/34 strand, #26 AWG, MIL-W-16878/4, Type E Teflon, yellow.
(H) 003 - 18", 7/34 strand, #26 AWG, MIL-W-16878/4, Type E Teflon, color coded to MIL-STD-681 System I.

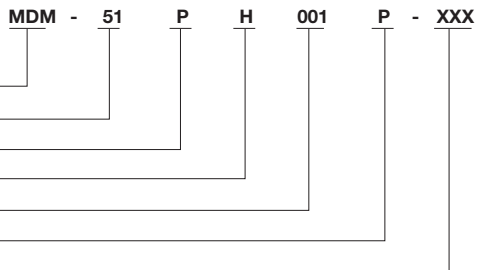

(L) 1 - 1/2" uninsulated solid #25 AWG gold plated copper.
(L) 2 - 1" uninsulated solid #25 AWG gold plated copper.

SHELL FINISH MOD CODES

No Number - (Standard cadmium/yellow chromate over nickel)
A174 - Electroless nickel
A172 - Gold over nickel
A141 - Iridite/alodine
A30 - Black anodize

*See page 79 and 81 for additional Termination codes.

7C2/7P2

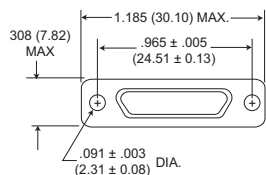

Plug

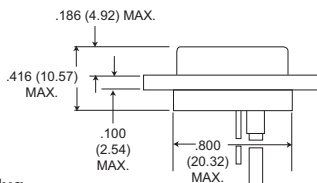

Receptacle

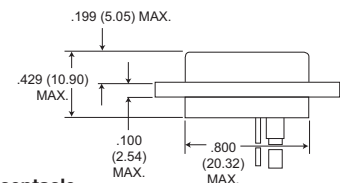
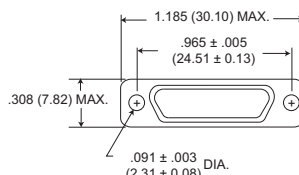

24C4/24P4

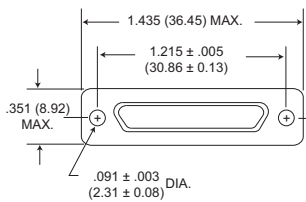

Plug

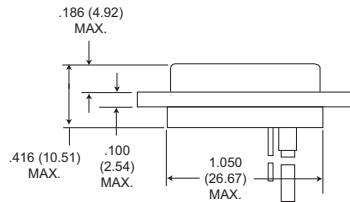

Receptacle

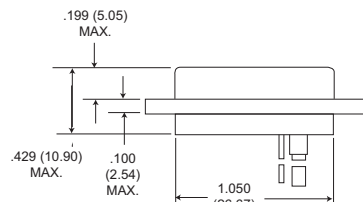
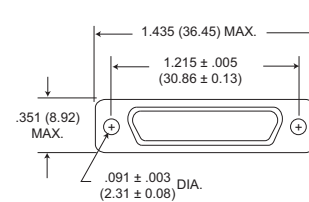

Power Contacts

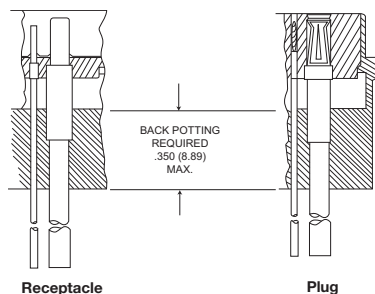

Receptacle

Plug

Coaxial Contacts

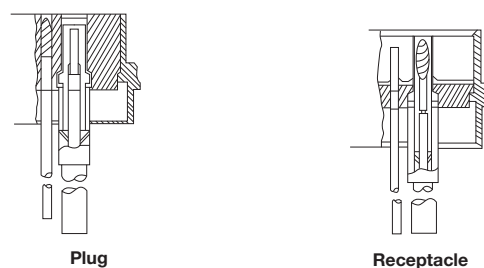

Plug

Receptacle



Dimensions shown in mm
Specifications and dimensions subject to

www.ittcannon.com

Connector Saver

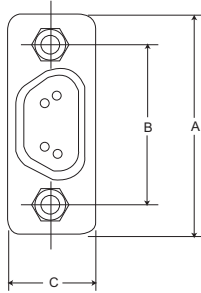

Save wear and tear on your equipment and simply mate the "Connectors Saver" to your systems connectors by using the "Connector Saver" and use the opposite side for your testing interface...less wear, less tear, less chance of damage. It is available in all eight standard MDM layouts. Mating hardware is available by most connectors during testing and finished can be ordered either separately or check out can be eliminated.

The multi-matings and unmatings experienced in MDM layouts. Mating hardware is available by most connectors during testing and finished can be ordered either separately or check out can be eliminated.

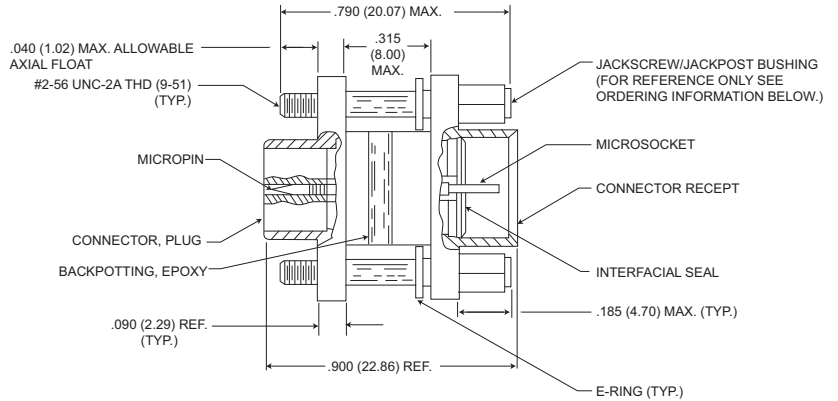

MDM Size 9 Shown

Size	Electroless Nickel (A174) Plated With Hardware	Electroless Nickel (A174) Plated W/O Hardware	Cadmium over Nickel (A101) Plated With Hardware	Cadmium over Nickel (A101) Plated W/O Hardware	*Hardware Kits	A Max.	B ± .005 (0.13)	C Max.
9	MDM98479-86	MDM98479-18	MDM98479-78	MDM-97294-371	320-9505-014**	.785 (19.94)	.565 (14.35)	.308 (7.82)
15	MDM98479-87	MDM98479-19	MDM98479-79	MDM-97294-372	320-9505-014**	.935 (23.75)	.715 (18.16)	.308 (7.82)
21	MDM98479-88	MDM98479-20	MDM98479-80	MDM-97294-373	320-9505-014**	1.085 (27.56)	.865 (21.97)	.308 (7.82)
25	MDM98479-89	MDM98479-21	MDM98479-81	MDM-97294-374	320-9505-014**	1.185 (30.10)	.965 (24.51)	.308 (7.82)
31	MDM98479-90	MDM98479-14	MDM98479-82	MDM-97294-375	320-9505-014**	1.335 (33.91)	1.115 (28.32)	.308 (7.82)
37	MDM98479-91	MDM98479-15	MDM98479-83	MDM-97294-376	320-9505-014**	1.485 (37.72)	1.265 (32.13)	.308 (7.82)
51	MDM98479-92	MDM98479-16	MDM98479-84	MDM-97294-377	320-9505-014**	1.435 (36.45)	1.215 (30.86)	.351 (8.91)
100	MDM98479-93	MDM98479-17	MDM98479-85	MDM-97294-717	320-9508-014***	2.170 (55.12)	1.800 (45.72)	.394 (10.01)

* Kit contains 2 jackpost/jackscrew bushings and 2 E-Rings.
 ** Size 9-51-#2-56 UNC-2B Thread
 *** Size 100-#4-40 UNC-2B Thread

Cross references - shell finish nickel

<u>Type</u>	<u>Description ESCC</u>	<u>ITT Description</u>	
Cable AWG 26 / PTFE Length 508,00 (20.000) Shell finish : Nickel	340102901B 9PFR112*	MDM-9PH038*-A174	
	340102901B 9SFR112*	MDM-9SH038*-A174	
	340102901B 15PFR112*	MDM-15PH038*-A174	
	340102901B 15SFR112*	MDM-15SH038*-A174	
	340102901B 21PFR112*	MDM-21PH038*-A174	
	340102901B 21SFR112*	MDM-21SH038*-A174	
	340102901B 25PFR112*	MDM-25PH038*-A174	
	340102901B 25SFR112*	MDM-25SH038*-A174	
	340102901B 31PFR112*	MDM-31PH038*-A174	
	340102901B 31SFR112*	MDM-31SH038*-A174	
	340102901B 37PFR112*	MDM-37PH038*-A174	
	340102901B 37SFR112*	MDM-37SH038*-A174	
	340102901B 51PFR112*	MDM-51PH038*-A174	
	340102901B 51SFR112*	MDM-51SH038*-A174	
	Cable AWG 26 / Polyimide Length 508,00 (20.000) Shell finish : Nickel	340102901B 9PFR112A*	
		340102901B 9SFR112A*	
340102901B 15PFR112A*			
340102901B 15SFR112A*			
340102901B 21PFR112A*			
340102901B 21SFR112A*			
340102901B 25PFR112A*			
340102901B 25SFR112A*			
340102901B 31PFR112A*			
340102901B 31SFR112A*			
340102901B 37PFR112A*			
340102901B 37SFR112A*			
340102901B 51PFR112A*			
340102901B 51SFR112A*			
Cable AWG 26 / PTFE Length 914,00 (36.000) Shell finish : Nickel		340102901B 9PFR113*	MDM-9PH011*-A174
		340102901B 9SFR113*	MDM-9SH011*-A174
	340102901B 15PFR113*	MDM-15PH011*-A174	
	340102901B 15SFR113*	MDM-15SH011*-A174	
	340102901B 21PFR113*	MDM-21PH011*-A174	
	340102901B 21SFR113*	MDM-21SH011*-A174	
	340102901B 25PFR113*	MDM-25PH011*-A174	
	340102901B 25SFR113*	MDM-25SH011*-A174	
	340102901B 31PFR113*	MDM-31PH011*-A174	
	340102901B 31SFR113*	MDM-31SH011*-A174	
	340102901B 37PFR113*	MDM-37PH011*-A174	
	340102901B 37SFR113*	MDM-37SH011*-A174	
	340102901B 51PFR113*	MDM-51PH011*-A174	
	340102901B 51SFR113*	MDM-51SH011*-A174	
	Cable AWG 26 / Polyimide Length 914,00 (36.000) Shell finish : Nickel	340102901B 9PFR113A*	
		340102901B 9SFR113A*	
340102901B 15PFR113A*			
340102901B 15SFR113A*			
340102901B 21PFR113A*			
340102901B 21SFR113A*			
340102901B 25PFR113A*			
340102901B 25SFR113A*			
340102901B 31PFR113A*			
340102901B 31SFR113A*			
340102901B 37PFR113A*			
340102901B 37SFR113A*			
340102901B 51PFR113A*			
340102901B 51SFR113A*			



<u>Type</u>	<u>Description ESCC</u>	<u>ITT Description</u>
Cable AWG 26 / PTFE Length 4000,00 (157.480) Shell finish : Nickel	340102901B 9PFR123*	
	340102901B 9SFR123*	
	340102901B 15PFR123*	
	340102901B 15SFR123*	
	340102901B 21PFR123*	
	340102901B 21SFR123*	
	340102901B 25PFR123*	
	340102901B 25SFR123*	
	340102901B 31PFR123*	
	340102901B 31SFR123*	
	340102901B 37PFR123*	
	340102901B 37SFR123*	
	340102901B 51PFR123*	
	340102901B 51SFR123*	
	Cable AWG 26 / Polyimide Length 4000,00 (157.480) Shell finish : Nickel	340102901B 9PFR123A*
340102901B 9SFR123A*		
340102901B 15PFR123A*		
340102901B 15SFR123A*		
340102901B 21PFR123A*		
340102901B 21SFR123A*		
340102901B 25PFR123A*		
340102901B 25SFR123A*		
340102901B 31PFR123A*		
340102901B 31SFR123A*		
340102901B 37PFR123A*		
340102901B 37SFR123A*		
340102901B 51PFR123A*		
340102901B 51SFR123A*		
Cable AWG 28 / PTFE Length 508,00 (20.000) Shell finish : Nickel		340102901B 9PFR114*
	340102901B 9SFR114*	MDM-9SH038-AWG28*
	340102901B 15PFR114*	MDM-15PH038-AWG28*
	340102901B 15SFR114*	MDM-15SH038-AWG28*
	340102901B 21PFR114*	MDM-21PH038-AWG28*
	340102901B 21SFR114*	MDM-21SH038-AWG28*
	340102901B 25PFR114*	MDM-25PH038-AWG28*
	340102901B 25SFR114*	MDM-25SH038-AWG28*
	340102901B 31PFR114*	MDM-31PH038-AWG28*
	340102901B 31SFR114*	MDM-31SH038-AWG28*
	340102901B 37PFR114*	MDM-37PH038-AWG28*
	340102901B 37SFR114*	MDM-37SH038-AWG28*
	340102901B 51PFR114*	MDM-51PH038-AWG28*
	340102901B 51SFR114*	MDM-51SH038-AWG28*
	Cable AWG 28 / Polyimide Length 508,00 (20.000) Shell finish : Nickel	340102901B 9PFR114A*
340102901B 9SFR114A*		
340102901B 15PFR114A*		
340102901B 15SFR114A*		
340102901B 21PFR114A*		
340102901B 21SFR114A*		
340102901B 25PFR114A*		
340102901B 25SFR114A*		
340102901B 31PFR114A*		
340102901B 31SFR114A*		
340102901B 37PFR114A*		
340102901B 37SFR114A*		
340102901B 51PFR114A*		
340102901B 51SFR114A*		

<u>Type</u>	<u>Description ESCC</u>	<u>ITT Description</u>	
Cable AWG 28 / PTFE Length 914,00 (36.000) Shell finish : Nickel	340102901B 9PFR115*	MDM-9PH011-AWG28*	
	340102901B 9SFR115*	MDM-9SH011-AWG28*	
	340102901B 15PFR115*	MDM-15PH011-AWG28*	
	340102901B 15SFR115*	MDM-15SH011-AWG28*	
	340102901B 21PFR115*	MDM-21PH011-AWG28*	
	340102901B 21SFR115*	MDM-21SH011-AWG28*	
	340102901B 25PFR115*	MDM-25PH011-AWG28*	
	340102901B 25SFR115*	MDM-25SH011-AWG28*	
	340102901B 31PFR115*	MDM-31PH011-AWG28*	
	340102901B 31SFR115*	MDM-31SH011-AWG28*	
	340102901B 37PFR115*	MDM-37PH011-AWG28*	
	340102901B 37SFR115*	MDM-37SH011-AWG28*	
	340102901B 51PFR115*	MDM-51PH011-AWG28*	
	340102901B 51SFR115*	MDM-51SH011-AWG28*	
	Cable AWG 28 / Polyimide Length 914,00 (36.000) Shell finish : Nickel	340102901B 9PFR115A*	
		340102901B 9SFR115A*	
340102901B 15PFR115A*			
340102901B 15SFR115A*			
340102901B 21PFR115A*			
340102901B 21SFR115A*			
340102901B 25PFR115A*			
340102901B 25SFR115A*			
340102901B 31PFR115A*			
340102901B 31SFR115A*			
340102901B 37PFR115A*			
340102901B 37SFR115A*			
340102901B 51PFR115A*			
340102901B 51SFR115A*			
Straight Pigtail Length 25,40 (1.000) Shell finish : Nickel	340102901B 9PFR116*	MDM-9PL2*-A174-FR022	
	340102901B 9SFR116*	MDM-9SL2*-A174-FR022	
	340102901B 15PFR116*	MDM-15PL2*-A174-FR022	
	340102901B 15SFR116*	MDM-15SL2*-A174-FR022	
	340102901B 21PFR116*	MDM-21PL2*-A174-FR022	
	340102901B 21SFR116*	MDM-21SL2*-A174-FR022	
	340102901B 25PFR116*	MDM-25PL2*-A174-FR022	
	340102901B 25SFR116*	MDM-25SL2*-A174-FR022	
	340102901B 31PFR116*	MDM-31PL2*-A174-FR022	
	340102901B 31SFR116*	MDM-31SL2*-A174-FR022	
	340102901B 37PFR116*	MDM-37PL2*-A174-FR022	
	340102901B 37SFR116*	MDM-37SL2*-A174-FR022	
	340102901B 51PFR116*	MDM-51PL2*-A174-FR022	
	340102901B 51SFR116*	MDM-51SL2*-A174-FR022	

Note * : Mounting code

Description ESCC :

- Remove the * when the connector is supplied without Hardware
- Replace the * by the letter E when the connector is supplied with the Captive Nut option
- Replace the * by the letter F when the connector is supplied with the Float Mount option

ITT Description :

- Replace the * by the letter B when the connector is supplied without Hardware
- Replace the * by the letter E when the connector is supplied with the Captive Nut option
- Replace the * by the letter F when the connector is supplied with the Float Mount option



<u>Type</u>	<u>Description ESCC</u>	<u>ITT Description</u>
90° bent PCB Length 4,50 (.177) Shell finish : Nickel	340102901B 9PFR136	MDM-9PFR136
	340102901B 9SFR136	MDM-9SFR136
	340102901B 15PFR136	MDM-15PFR136
	340102901B 15SFR136	MDM-15SFR136
	340102901B 21PFR136	MDM-21PFR136
	340102901B 21SFR136	MDM-21SFR136
	340102901B 25PFR136	MDM-25PFR136
	340102901B 25SFR136	MDM-25SFR136
	340102901B 31PFR136	MDM-31PFR136
	340102901B 31SFR136	MDM-31SFR136
	340102901B 37PFR136	MDM-37PFR136
	340102901B 37SFR136	MDM-37SFR136
	340102901B 51PFR136	MDM-51PFR136
	340102901B 51SFR136	MDM-51SFR136
90° bent PCB / Narrow Length 3,50 (.138) Shell finish : Nickel	340102901B 9PFR136A	MDM-9PFR136
	340102901B 9SFR136A	MDM-9SFR136
Straight PCB Length 4,50 (.177) Shell finish : Nickel	340102901B 9PFR139	MDM-9PFR139
	340102901B 9SFR139	MDM-9SFR139
	340102901B 15PFR139	MDM-15PFR139
	340102901B 15SFR139	MDM-15SFR139
	340102901B 21PFR139	MDM-21PFR139
	340102901B 21SFR139	MDM-21SFR139
	340102901B 25PFR139	MDM-25PFR139
	340102901B 25SFR139	MDM-25SFR139
	340102901B 31PFR139	MDM-31PFR139
	340102901B 31SFR139	MDM-31SFR139
	340102901B 37PFR139	MDM-37PFR139
	340102901B 37SFR139	MDM-37SFR139

Cross references - shell finish gold

<u>Type</u>	<u>Description ESCC</u>	<u>ITT Description</u>	
Cable AWG 26 / PTFE Length 508,00 (20.000) Shell finish : Gold	340102902B 9PFR112*	MDM-9PH038*-A172	
	340102902B 9SFR112*	MDM-9SH038*-A172	
	340102902B 15PFR112*	MDM-15PH038*-A172	
	340102902B 15SFR112*	MDM-15SH038*-A172	
	340102902B 21PFR112*	MDM-21PH038*-A172	
	340102902B 21SFR112*	MDM-21SH038*-A172	
	340102902B 25PFR112*	MDM-25PH038*-A172	
	340102902B 25SFR112*	MDM-25SH038*-A172	
	340102902B 31PFR112*	MDM-31PH038*-A172	
	340102902B 31SFR112*	MDM-31SH038*-A172	
	340102902B 37PFR112*	MDM-37PH038*-A172	
	340102902B 37SFR112*	MDM-37SH038*-A172	
	340102902B 51PFR112*	MDM-51PH038*-A172	
	340102902B 51SFR112*	MDM-51SH038*-A172	
	Cable AWG 26 / Polyimide Length 508,00 (20.000) Shell finish : Gold	340102902B 9PFR112A*	
		340102902B 9SFR112A*	
		340102902B 15PFR112A*	
340102902B 15SFR112A*			
340102902B 21PFR112A*			
340102902B 21SFR112A*			
340102902B 25PFR112A*			
340102902B 25SFR112A*			
340102902B 31PFR112A*			
340102902B 31SFR112A*			
340102902B 37PFR112A*			
340102902B 37SFR112A*			
340102902B 51PFR112A*			
340102902B 51SFR112A*			
Cable AWG 26 / PTFE Length 914,00 (36.000) Shell finish : Gold	340102902B 9PFR113*	MDM-9PH011*-A172	
	340102902B 9SFR113*	MDM-9SH011*-A172	
	340102902B 15PFR113*	MDM-15PH011*-A172	
	340102902B 15SFR113*	MDM-15SH011*-A172	
	340102902B 21PFR113*	MDM-21PH011*-A172	
	340102902B 21SFR113*	MDM-21SH011*-A172	
	340102902B 25PFR113*	MDM-25PH011*-A172	
	340102902B 25SFR113*	MDM-25SH011*-A172	
	340102902B 31PFR113*	MDM-31PH011*-A172	
	340102902B 31SFR113*	MDM-31SH011*-A172	
	340102902B 37PFR113*	MDM-37PH011*-A172	
	340102902B 37SFR113*	MDM-37SH011*-A172	
	340102902B 51PFR113*	MDM-51PH011*-A172	
	340102902B 51SFR113*	MDM-51SH011*-A172	
Cable AWG 26 / Polyimide Length 914,00 (36.000) Shell finish : Gold	340102902B 9PFR113A*		
	340102902B 9SFR113A*		
	340102902B 15PFR113A*		
	340102902B 15SFR113A*		
	340102902B 21PFR113A*		
	340102902B 21SFR113A*		
	340102902B 25PFR113A*		
	340102902B 25SFR113A*		
	340102902B 31PFR113A*		
	340102902B 31SFR113A*		
	340102902B 37PFR113A*		
	340102902B 37SFR113A*		
	340102902B 51PFR113A*		
	340102902B 51SFR113A*		



<u>Type</u>	<u>Description ESCC</u>	<u>ITT Description</u>
Cable AWG 26 / PTFE Length 4000,00 (157.480) Shell finish : Gold	340102902B 9PFR123*	
	340102902B 9SFR123*	
	340102902B 15PFR123*	
	340102902B 15SFR123*	
	340102902B 21PFR123*	
	340102902B 21SFR123*	
	340102902B 25PFR123*	
	340102902B 25SFR123*	
	340102902B 31PFR123*	
	340102902B 31SFR123*	
	340102902B 37PFR123*	
	340102902B 37SFR123*	
	340102902B 51PFR123*	
	340102902B 51SFR123*	
	Cable AWG 26 / Polyimide Length 4000,00 (157.480) Shell finish : Gold	340102902B 9PFR123A*
340102902B 9SFR123A*		
340102902B 15PFR123A*		
340102902B 15SFR123A*		
340102902B 21PFR123A*		
340102902B 21SFR123A*		
340102902B 25PFR123A*		
340102902B 25SFR123A*		
340102902B 31PFR123A*		
340102902B 31SFR123A*		
340102902B 37PFR123A*		
340102902B 37SFR123A*		
340102902B 51PFR123A*		
340102902B 51SFR123A*		
Cable AWG 28 / PTFE Length 508,00 (20.000) Shell finish : Gold		340102902B 9PFR114*
	340102902B 9SFR114*	MDM-9SH038-AWG28*-A172
	340102902B 15PFR114*	MDM-15PH038-AWG28*-A172
	340102902B 15SFR114*	MDM-15SH038-AWG28*-A172
	340102902B 21PFR114*	MDM-21PH038-AWG28*-A172
	340102902B 21SFR114*	MDM-21SH038-AWG28*-A172
	340102902B 25PFR114*	MDM-25PH038-AWG28*-A172
	340102902B 25SFR114*	MDM-25SH038-AWG28*-A172
	340102902B 31PFR114*	MDM-31PH038-AWG28*-A172
	340102902B 31SFR114*	MDM-31SH038-AWG28*-A172
	340102902B 37PFR114*	MDM-37PH038-AWG28*-A172
	340102902B 37SFR114*	MDM-37SH038-AWG28*-A172
	340102902B 51PFR114*	MDM-51PH038-AWG28*-A172
	340102902B 51SFR114*	MDM-51SH038-AWG28*-A172
	Cable AWG 28 / Polyimide Length 508,00 (20.000) Shell finish : Gold	340102902B 9PFR114A*
340102902B 9SFR114A*		
340102902B 15PFR114A*		
340102902B 15SFR114A*		
340102902B 21PFR114A*		
340102902B 21SFR114A*		
340102902B 25PFR114A*		
340102902B 25SFR114A*		
340102902B 31PFR114A*		
340102902B 31SFR114A*		
340102902B 37PFR114A*		
340102902B 37SFR114A*		
340102902B 51PFR114A*		
340102902B 51SFR114A*		

<u>Type</u>	<u>Description ESCC</u>	<u>ITT Description</u>	
Cable AWG 28 / PTFE Length 914,00 (36.000) Shell finish : Gold	340102902B 9PFR115*	MDM-9PH011-AWG28*-A172	
	340102902B 9SFR115*	MDM-9SH011-AWG28*-A172	
	340102902B 15PFR115*	MDM-15PH011-AWG28*-A172	
	340102902B 15SFR115*	MDM-15SH011-AWG28*-A172	
	340102902B 21PFR115*	MDM-21PH011-AWG28*-A172	
	340102902B 21SFR115*	MDM-21SH011-AWG28*-A172	
	340102902B 25PFR115*	MDM-25PH011-AWG28*-A172	
	340102902B 25SFR115*	MDM-25SH011-AWG28*-A172	
	340102902B 31PFR115*	MDM-31PH011-AWG28*-A172	
	340102902B 31SFR115*	MDM-31SH011-AWG28*-A172	
	340102902B 37PFR115*	MDM-37PH011-AWG28*-A172	
	340102902B 37SFR115*	MDM-37SH011-AWG28*-A172	
	340102902B 51PFR115*	MDM-51PH011-AWG28*-A172	
	340102902B 51SFR115*	MDM-51SH011-AWG28*-A172	
	Cable AWG 28 / Polyimide Length 914,00 (36.000) Shell finish : Gold	340102902B 9PFR115A*	
		340102902B 9SFR115A*	
340102902B 15PFR115A*			
340102902B 15SFR115A*			
340102902B 21PFR115A*			
340102902B 21SFR115A*			
340102902B 25PFR115A*			
340102902B 25SFR115A*			
340102902B 31PFR115A*			
340102902B 31SFR115A*			
340102902B 37PFR115A*			
340102902B 37SFR115A*			
340102902B 51PFR115A*			
340102902B 51SFR115A*			
Straight Pigtail Length 25,40 (1.000) Shell finish : Gold	340102902B 9PFR116*	MDM-9PL2*-A172	
	340102902B 9SFR116*	MDM-9SL2*-A172	
	340102902B 15PFR116*	MDM-15PL2*-A172	
	340102902B 15SFR116*	MDM-15SL2*-A172	
	340102902B 21PFR116*	MDM-21PL2*-A172	
	340102902B 21SFR116*	MDM-21SL2*-A172	
	340102902B 25PFR116*	MDM-25PL2*-A172	
	340102902B 25SFR116*	MDM-25SL2*-A172	
	340102902B 31PFR116*	MDM-31PL2*-A172	
	340102902B 31SFR116*	MDM-31SL2*-A172	
	340102902B 37PFR116*	MDM-37PL2*-A172	
	340102902B 37SFR116*	MDM-37SL2*-A172	
	340102902B 51PFR116*	MDM-51PL2*-A172	
340102902B 51SFR116*	MDM-51SL2*-A172		

Note * : Mounting code

Description ESCC :

- Remove the * when the connector is supplied without Hardware
- Replace the * by the letter E when the connector is supplied with the Captive Nut option
- Replace the * by the letter F when the connector is supplied with the Float Mount option

ITT Description:

- Replace the * by the letter B when the connector is supplied without Hardware
- Replace the * by the letter E when the connector is supplied with the Captive Nut option
- Replace the * by the letter F when the connector is supplied with the Float Mount option



<u>Type</u>	<u>Description ESCC</u>	<u>ITT Description</u>
90° bent PCB Length 4,50 (.177) Shell finish : Gold	340102902B 9PFR136	MDM-9PFR136-A172
	340102902B 9SFR136	MDM-9SFR136-A172
	340102902B 15PFR136	MDM-15PFR136-A172
	340102902B 15SFR136	MDM-15SFR136-A172
	340102902B 21PFR136	MDM-21PFR136-A172
	340102902B 21SFR136	MDM-21SFR136-A172
	340102902B 25PFR136	MDM-25PFR136-A172
	340102902B 25SFR136	MDM-25SFR136-A172
	340102902B 31PFR136	MDM-31PFR136-A172
	340102902B 31SFR136	MDM-31SFR136-A172
	340102902B 37PFR136	MDM-37PFR136-A172
	340102902B 37SFR136	MDM-37SFR136-A172
	340102902B 51PFR136	MDM-51PFR136-A172
	340102902B 51SFR136	MDM-51SFR136-A172
	90° bent PCB / Narrow Length 3,50 (.138) Shell finish : Gold	340102902A 9PFR136A
340102902B 9SFR136A		MDM-9SFR136-A172
Straight PCB Length 4,50 (.177) Shell finish : Gold	340102902B 9PFR139	MDM-9PFR139-A172
	340102902B 9SFR139	MDM-9SFR139-A172
	340102902B 15PFR139	MDM-15PFR139-A172
	340102902B 15SFR139	MDM-15SFR139-A172
	340102902B 21PFR139	MDM-21PFR139-A172
	340102902B 21SFR139	MDM-21SFR139-A172
	340102902B 25PFR139	MDM-25PFR139-A172
	340102902B 25SFR139	MDM-25SFR139-A172
	340102902B 31PFR139	MDM-31PFR139-A172
	340102902B 31SFR139	MDM-31SFR139-A172
	340102902B 37PFR139	MDM-37PFR139-A172
	340102902B 37SFR139	MDM-37SFR139-A172

Meets the Thermal Vacuum Outgassing requirements of Mil-DTL 38999 Class G

Applications

- Space
- Satellite
- Aerospace Vacuum Environment

Product Features and Benefits

- Connectors having harmful materials are removed from its polymers which is essential in Space applications
- High Density Layout, up to 128 contacts
- EMI Shielding
- Scoop proof pin contacts ideal for blind mate applications
- Strong distribution inventory position for immediate demands

Performance Specifications

Finish	Electroless Nickel
Shell Sizes	9-25
Temperature Rating	200°C (392°F)
Contact Sizes	8-22D
Wire Sizes	12 AWG to 28 AWG
Durability	500 cycles, Series I and II

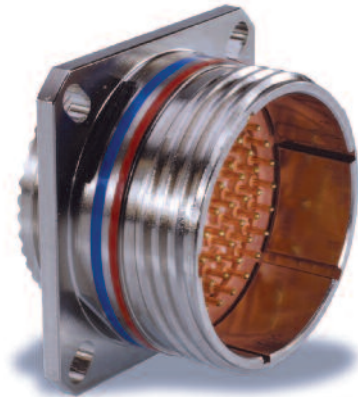

Materials and Finish

Material	Finish/Treatment
Shells	Aluminum Alloy
Insulator	Copper Alloy, Gold plated
Grommets / Seals	Silicone based elastomer
Jam Nut	Aluminum Alloy
Finish	Electroless Nickel

How to Order:

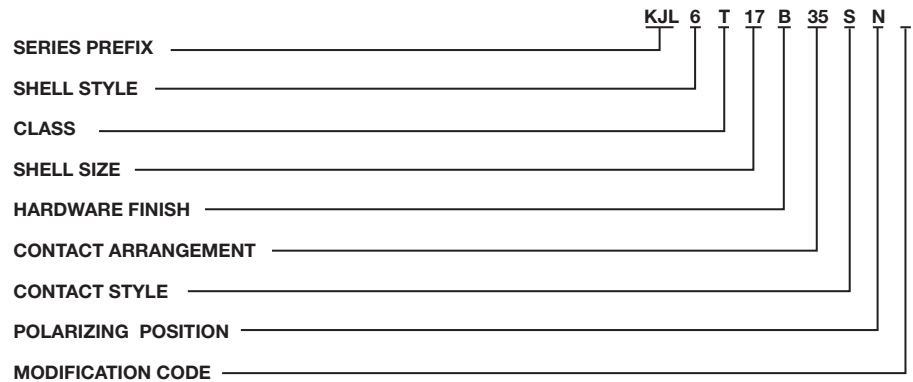

SERIES PREFIX

KJL - Series I-Scoop proof

SHELL STYLE

- 0 - Wall mounting receptacle
- 3 - Wall mounting receptacle (back panel mounting)
- 5 - Box mounting receptacle (back panel mounting)
- 6 - Straight plug, grounded
- 7 - Jam nut receptacle

CLASS

- E - Inactive for new design. Superseded by Class T.
- F - Environment - resistant with strain relief accessory
- P - Environment - resistant with straight potting cup accessory
- T - Environment - resistant (without rear accessory) (Class T not applicable to KJL5)

SHELL SIZE

9,11,13,15,17,19,21,23 and 25

HARDWARE FINISH STANDARD

- A - Bright cadmium over electroless nickel plate, -85°F to +302°F (-65°C to +150°C)
- B - Olive drab cadmium over electroless nickel plate, -85°F to +347°F (-65°C to +175°C)
- N - Electroless nickel, -85°F to +392°F (-65°C to +200°C)

CONTACT ARRANGEMENT

See pages 20 and 21.

CONTACT STYLE

- P - Pin
- S - Socket

POLARIZING POSITION

N (normal), A, B, C, D. See page 19.

MODIFICATION CODE

- L - Less contacts, not stamped on connector
- 16 - Outgassed NASA space graded connector
- 27 - Outgassed, standard connector

SERIES I

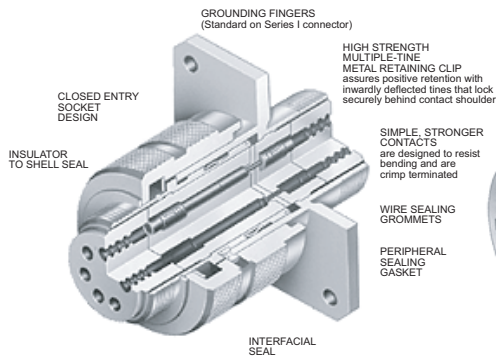

SERIES II

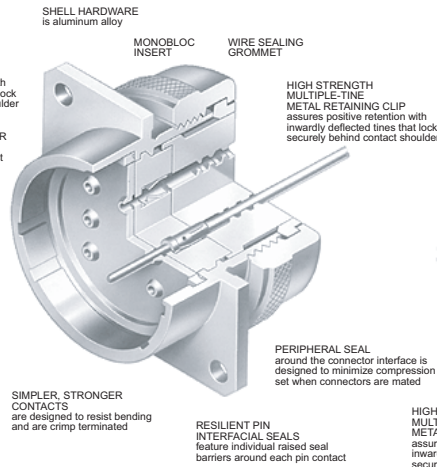

SERIES III

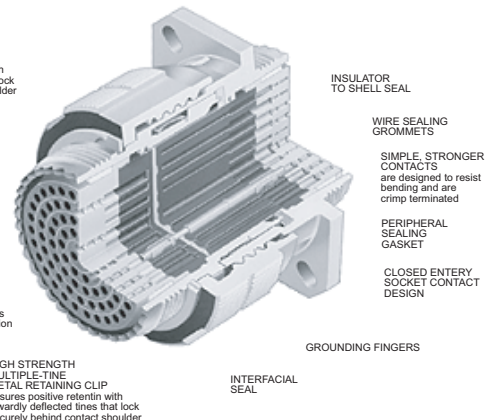

- Corrosion-resistant shells of aluminum alloy with cadmium over nickel plating withstand a 500 hour salt spray exposure
- Rear release crimp snap-in contacts
- High contact density
- Standard MIL-C-39029 contacts, MIL-I-81969 application tools and MIL-STD 1560 insert arrangements

- Special/custom capabilities
- 100% scoop-proof - Series I and III
- Light weight /Low Profile - Series II
- Operates under severe high temperature vibration testing through 200 C - engineered for high density circuitry - Series III

- Interfacial seal helps prevent electrolytic erosion of contacts - Series III
- Superior EMI shielding provides outstanding protection up to 65dB at 10 GHZ. - Series III

Specification Comparison

Design Criteria	Series I	Series II	Series III
Low Profile/Light Weight	no	yes	no
Scoop Proof	yes	no	yes
Coupling System	Bayonet	Bayonet	Triple Lead Thread
Electrolytic Erosion	no	no	yes
Durability (Cycles)	500	250	500
High Impact Shock	yes	no	yes
External Bending Moment			
Shell Size 25	650 in/lbs	150 in/lbs	1000 in/lbs
Random Vibration "J"	Ambient	Ambient	492 F
Sine Vibration	30G, Ambient		60G, -85 to +392 F
Sand, Dust, Ice	yes		yes
Shell Size	9-25	8-24	9-25

Contact Rating

Contact Size	Test Current DC Test Amperage	Maximum Millivolt Drop*	Crimp Well Data	
			Well Diameter	Well Depth
22D	5	40	.0345 ± .0010	.157/.141
22M**	3	30	.0280 ± .0010	.157/.141
22**	5	40	.0365 ± .0010	.157/.141
20	7.5	35	.0470 ± .0010	.229/.209
16	13	25	.0670 ± .0010	.229/.209
12	23	25	.1000 ± .0020	.229/.209

* Maximum millivolt drop data is determined by measuring resistance of mated contacts from end to end

** For reference only

Dimensions shown in mm
Specifications and dimensions subject to change

Performance and Material Specifications

MATERIALS AND FINISHES

	Receptacle	Grounded Plug
Shell	Aluminum alloy	Aluminum alloy*
Insulator	High grade plastic	High grade plastic
Contacts	Copper alloy, gold plate	Copper alloy, gold plate
Grommet and Seal	Silicone base elastomer	Silicone base elastomer
Jam Nut	Aluminum alloy	-
Grounding Spring	-	Beryllium copper

*Finish as noted in How To Order sections.

ELECTRICAL DATA

Contact Size: 22D, 22M*, 22*, 20, 16 and 12

Contact Rating and Wire Size Accomodation

Wire Size	Contact Size and Test Amps					
	22D	22M*	22*	20	16	12
28	1.5	1.5	-	-	-	-
26	2.0	2.0	2.0	-	-	-
24	3.0	3.0	3.0	3.0	-	-
22	5.0	-	5.0	5.0	-	-
20	-	-	-	7.5	7.5	-
18	-	-	-	-	10.0	-
16	-	-	-	-	13.0	-
14	-	-	-	-	-	17.0
12	-	-	-	-	-	23.0

*For reference only

Service Rating

Altitude	Service Rating M		Service Rating N		Service Rating I		Service Rating II	
	Mated	Unmated	Mated	Unmated	Mated	Unmated	Mated	Unmated
Sea Level	1300	1300	1000	1000	1800	1800	2300	2300
50,000 ft.	800	550	600	400	1000	600	1000	800
70,000 ft.	800	350	600	260	1000	400	1000	500
100,000 ft.	800	200	600	200	1000	200	1000	200

Test voltage, AC (rms)

Test Data

Test Description	Parameters
Durability	500 cycles of mating and unmating, 250 cycles for Series II with spring fingers
Temperature Range	Class F, N; - 65°C (-85°F) to + 200°C (+392°F) Class A; - 65°C (-85°F) to + 150°C (+302°F) Class B,W: - 65°C (-85°F) to + 175°C (+347°F)
Vibration	Mated connectors are vibrated with weights to simulate rear accessory loads to the following levels: Sine Vibration: Up to 60 G's - Series I & III (at rated temperature - Series III) Not applicable for Series II. Random Vibration: 43.7 Grms at rated temperature - Series III 49.5 Grms at Ambient Temperature - Series I & III 43.7 Grms at Ambient Temperature - Series II
EMI Shielding Effectiveness	Class F: EMI leakage attenuation, greater than 90dB at 100Mhz, greater than 65dB at 10 GHz. Shell to shell conductivity, 1.0 millivolt max. resistance. Class W: EMI leakage attenuation, greater than 90dB at 100 MHz, greater than 50dB at 10 GHz. Shell to shell conductivity, 2.5 millivolt max.
Corrosion Resistant	Class B, W, will withstand 500 hours salt spray. Class A, F, N, will withstand 48 hours salt spray.
Fluid Immersion	Connectors are fluid resistant to many fuels, solvents, coolants and oils.
High Impact Shock	Mated connectors terminated with MIL-C-915 cable and environmentally sealed backshells will withstand high impact shock per MIL-S-901. Applicable to Series I & III only.
Altitude	Designed to operate between sea level and 100,000 ft. above sea level.
Other Environments	Mated connectors shall withstand sand and dust per method 110 of MIL-STD-202 and be ice resistant. Applicable to Series I & III only.

NOTE: For hermetic standard or test data please consult ITT.

Insert Availability and Identification

Series II	Series I & III	Service Rating	Total Contacts	Contact Size				
				22D	20	16	12	8
8-35	9-35	M	6	6				
8-98	9-98	I	3		3			
	11-4	I	4		4			
10-5	11-5	I	5		5			
10-35	11-35	M	13	13				
10-98	11-98	I	6		6			
10-99	11-99	I	7		7			
12-3		II	3				3	
12-4	13-4	I	4				4	
12-8	13-8	I	8		8			
12-35	13-35	M	22	22				
12-98	13-98	I	10		10			
14-5	15-5	II	5				5	
14-15	15-15	I	15		14	1		
14-18	15-18	I	18		18			
	15-19	I	19		19			
14-35	15-35	M	37	37				
14-97	15-97	I	12		8	4		
16-6	17-6	I	6					6
16-8	17-8	II	8			8		
16-26	17-26	I	26		26			
16-35	17-35	M	55	55				
16-99	17-99	I	23		21	2		
18-11	19-11	II	11				11	
18-28	19-28	I	28		26	2		
18-30	19-30	I	30		29	1		
18-32	19-32	I	32		32			
18-35	19-35	M	66	66				
	21-11	I	11					11
20-16	21-16	II	16			16		
20-35	21-35	M	79	79				
20-39	21-39	I	39		37	2		
20-41	21-41	I	41		41			
	21-75	M	4					4***
22-21	23-21	II	21			21		
22-32	23-32	I	32		32			
22-35	23-35	M	100	100				
22-53	23-53	I	53		53			
22-55	23-55	I	55		55			
24-4	25-4	I	56		48	8		
	25-19	I	19					19
24-24	25-24	I	24			12	12	
24-29	25-29	I	29			29		
24-35	25-35	M	128	128				
	25-37	I	37			37		
	25-43	I	43		23	20		
	25-46	I, Twinax	46		40	4		2***
	25-8	Twinax	8					8***
	25-20	N, Coax, Twinax	30		10	13	4**	3***
	25-42	I, Coax	42		38			4*
24-61	25-61	I	61		61			
	25-64	I	64	40	8	10	6	
	25-66	I	66	53	2	11		

* Coax for RG-180 cables

** Coax for RG-174, -179, or -316 cables

*** Twinax for M17/176-00002 cables

(check factory for other cable applications)



Wall Mounting Receptacle

MS27472
(MS service class E, P, T)

KJ0

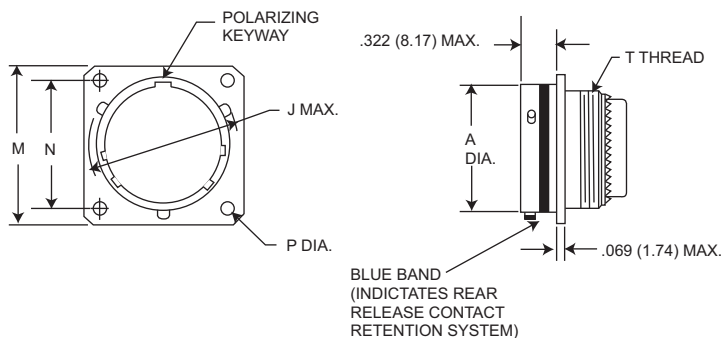

Shell Size	A Dia. Max.	J Dia. Max.	M Max.	N T.P.	P +.005 (0.13) - .010 (0.25)	T Thread	Overall length With Backshells		
							E Straight	F Cable Clamp	P Potting Max.
8	.474 (12.04)	.563 (14.30)	.828 (21.03)	.594 (15.09)	.125 (3.18)	7/16-28UNEF-2A	.850 (21.59)	1.555 (39.50)	1.020 (25.91)
10	.591 (15.01)	.680 (17.27)	.954 (24.23)	.719 (18.26)	.125 (3.18)	9/16-24UNEF-2A	.850 (21.59)	1.555 (39.50)	1.020 (25.91)
12	.751 (19.08)	.859 (21.82)	1.047 (26.59)	.812 (20.62)	.125 (3.18)	11/16-24UNEF-2A	.850 (21.59)	1.555 (39.50)	1.020 (25.91)
14	.876 (22.25)	.984 (24.99)	1.141 (28.98)	.906 (23.01)	.125 (3.18)	13/16-20UNEF-2A	.850 (21.59)	1.790 (45.47)	1.020 (25.91)
16	1.001 (25.43)	1.108 (28.14)	1.234 (31.34)	.969 (24.61)	.125 (3.18)	15/16-20UNEF-2A	.850 (21.59)	1.790 (45.47)	1.020 (25.91)
18	1.126 (28.60)	1.233 (31.32)	1.328 (33.73)	1.062 (26.97)	.125 (3.18)	1-1/16-18UNEF-2A	.850 (21.59)	1.790 (45.47)	1.020 (25.91)
20	1.251 (31.78)	1.358 (34.49)	1.453 (36.91)	1.156 (27.36)	.125 (3.18)	1-3/16-18UNEF-2A	.850 (21.59)	1.790 (45.47)	1.020 (25.91)
22	1.376 (34.95)	1.483 (37.67)	1.578 (39.08)	1.250 (31.76)	.125 (3.18)	1-5/16-18UNEF-2A	.850 (21.59)	1.930 (49.02)	1.020 (25.91)
24	1.501 (38.13)	1.610 (40.89)	1.703 (43.26)	1.375 (34.92)	.152 (3.86)	1-7/16-18UNEF-2A	.850 (21.59)	1.900 (48.26)	1.080 (27.43)

Box Mounting Receptacle

MS27499E
(MS service class E)

KJ2E

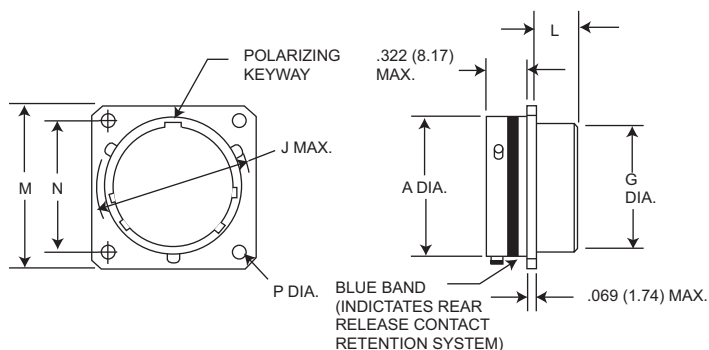

NOTE: This connector does not accommodate backshells

Shell Size	A Dia. Max.	G Dia. Max.	J Dia. Max.	L Max.	M Max.	N T.P.	P +.005 (0.13) - .010 (0.25)
8	.474 (12.04)	.421 (10.69)	.563 (14.30)	.312 (7.92)	.828 (21.03)	.594 (15.09)	.125 (3.18)
10	.591 (15.01)	.542 (13.77)	.680 (17.27)	.312 (7.92)	.954 (24.23)	.719 (18.26)	.125 (3.18)
12	.751 (19.08)	.667 (16.94)	.859 (21.82)	.312 (7.92)	1.047 (26.59)	.812 (20.62)	.125 (3.18)
14	.876 (22.25)	.791 (20.09)	.984 (24.99)	.312 (7.92)	1.141 (28.98)	.906 (23.01)	.125 (3.18)
16	1.001 (25.43)	.916 (23.27)	1.108 (28.14)	.312 (7.92)	1.234 (31.34)	.969 (24.61)	.125 (3.18)
18	1.126 (28.60)	1.034 (26.26)	1.233 (31.32)	.312 (7.92)	1.328 (33.73)	1.062 (26.97)	.125 (3.18)
20	1.251 (31.78)	1.158 (29.41)	1.358 (34.49)	.312 (7.92)	1.453 (36.81)	1.156 (27.36)	.125 (3.18)
22	1.376 (33.95)	1.283 (32.59)	1.483 (37.67)	.312 (7.92)	1.578 (40.08)	1.250 (31.75)	.125 (3.18)
24	1.501 (38.13)	1.408 (35.76)	1.610 (40.89)	.312 (7.92)	1.703 (43.26)	1.375 (34.93)	.152 (3.86)

Dimensions shown in mm
Specifications and dimensions subject to
www.ittcannon.com



Box Mounting Receptacle

MS27513E
(MS service class E)

KJ2R

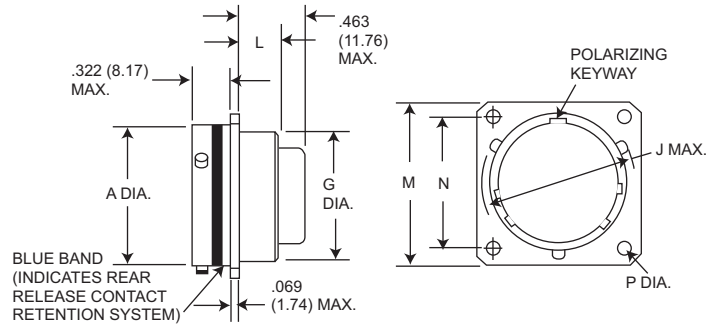

NOTE: This connector does not accommodate backshells

Shell Size	A Dia. Max.	G Dia. Max.	J Dia. Max.	L Max.	M Max.	N T.P.	P +.005 (0.13) -.010 (0.25)
8	.474 (12.04)	.421 (10.69)	.563 (14.30)	.312 (7.92)	.828 (21.03)	.594 (15.09)	.125 (3.18)
10	.591 (15.01)	.542 (13.77)	.680 (17.27)	.312 (7.92)	.954 (24.23)	.719 (18.26)	.125 (3.18)
12	.751 (19.08)	.667 (16.94)	.859 (21.82)	.312 (7.92)	1.047 (26.59)	.812 (20.62)	.125 (3.18)
14	.876 (22.25)	.791 (20.09)	.984 (24.99)	.312 (7.92)	1.141 (28.98)	.906 (23.01)	.125 (3.18)
16	1.001 (25.43)	.916 (23.27)	1.108 (28.14)	.312 (7.92)	1.234 (31.34)	.969 (24.61)	.125 (3.18)
18	1.126 (28.60)	1.034 (26.26)	1.233 (31.32)	.312 (7.92)	1.328 (33.73)	1.062 (26.97)	.125 (3.18)
20	1.251 (31.78)	1.158 (29.41)	1.358 (34.49)	.312 (7.92)	1.453 (36.81)	1.156 (27.36)	.125 (3.18)
22	1.376 (33.95)	1.283 (32.59)	1.483 (37.67)	.312 (7.92)	1.578 (40.08)	1.250 (31.75)	.125 (3.18)
24	1.501 (38.13)	1.408 (35.76)	1.610 (40.89)	.312 (7.92)	1.703 (43.26)	1.375 (34.93)	.152 (3.85)

Wall Mounting Receptacle

MS27497
(MS service class E, P, T)

KJ3

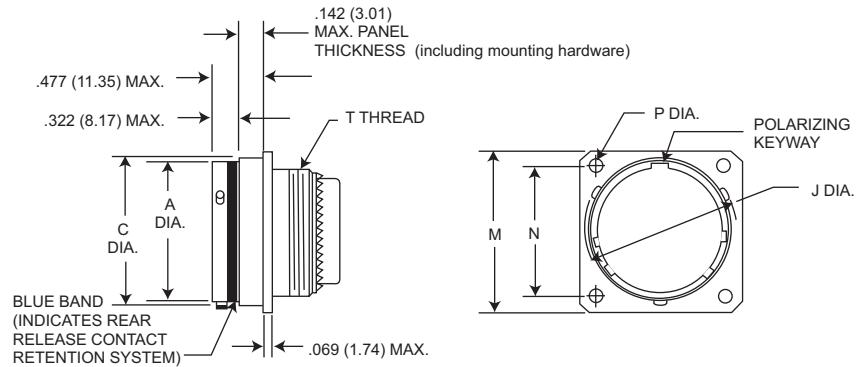

Shell Size	A Dia. Max.	C Dia. Max.	J Dia. Max.	M Max.	N T.P.	P +.005 (0.13) -.010 (0.25)	T Thread	Overall Length With Backshells		
								E Straight	F Cable Clamp	P Potting Max.
8	.474 (12.04)	.522 (13.26)	.563 (14.30)	.828 (21.03)	.594 (15.09)	.125 (3.18)	7/16-28UNEF-2A	.855 (21.72)	1.570 (39.88)	1.020 (25.91)
10	.591 (15.01)	.639 (16.23)	.680 (17.27)	.954 (24.23)	.719 (18.26)	.125 (3.18)	9/16-24UNEF-2A	.855 (21.72)	1.570 (39.88)	1.020 (25.91)
12	.751 (19.08)	.808 (20.52)	.859 (21.82)	1.047 (26.59)	.812 (20.62)	.125 (3.18)	11/16-24UNEF-2A	.855 (21.72)	1.570 (39.88)	1.020 (25.91)
14	.876 (22.25)	.935 (23.75)	.984 (24.99)	1.141 (28.98)	.906 (23.01)	.125 (3.18)	13/16-20UNEF-2A	.855 (21.72)	1.780 (45.21)	1.020 (25.91)
16	1.001 (25.43)	1.058 (26.87)	1.108 (28.14)	1.234 (31.34)	.969 (24.61)	.125 (3.18)	15/16-20UNEF-2A	.855 (21.72)	1.780 (45.21)	1.020 (25.91)
18	1.126 (28.60)	1.183 (30.05)	1.233 (31.32)	1.328 (33.73)	1.062 (26.97)	.125 (3.18)	1-1/16-18UNEF-2A	.855 (21.72)	1.780 (45.21)	1.020 (25.91)
20	1.251 (31.78)	1.308 (33.22)	1.358 (34.49)	1.453 (36.91)	1.156 (29.36)	.125 (3.18)	1-3/16-18UNEF-2A	.855 (21.72)	1.780 (45.21)	1.020 (25.91)
22	1.376 (34.95)	1.433 (36.40)	1.483 (37.67)	1.578 (40.08)	1.250 (31.75)	.125 (3.18)	1-5/16-18UNEF-2A	.855 (21.72)	1.960 (49.78)	1.020 (25.91)
24	1.501 (38.13)	1.568 (39.83)	1.610 (40.89)	1.703 (43.26)	1.375 (34.93)	.152 (3.86)	1-7/16-18UNEF-2A	.855 (21.72)	1.960 (49.78)	1.080 (27.43)



Dimensions shown in mm
Specifications and dimensions subject to
www.ittcannon.com

Box Mounting Receptacle (Back Panel)

MS27508E
(MS service class E)

KJ5E

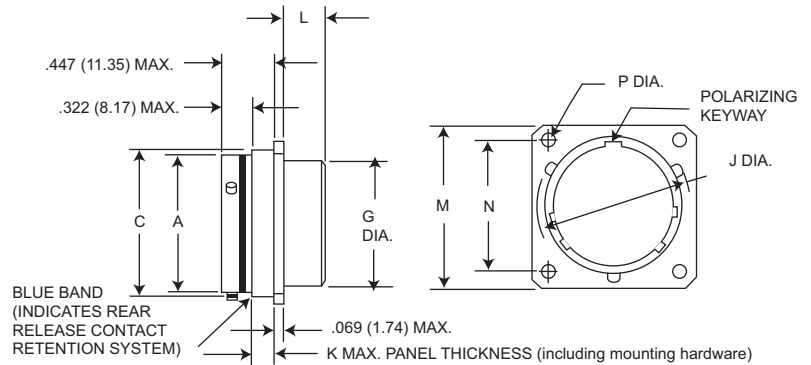

NOTE: This connector does not accommodate backshells

Shell Size	A Dia. Max.	C Dia. Max.	G Dia. Max.	J Dia. Max.	K Max.	L Max.	M Max.	N T.P	P +.005 (0.13) -0.010 (0.25)
8	.474 (12.04)	.522 (13.26)	.421 (10.69)	.563 (14.30)	.147 (3.73)	.185 (4.70)	.828 (21.03)	.594 (15.09)	.125 (3.18)
10	.591 (15.01)	.639 (16.23)	.542 (13.77)	.680 (17.27)	.152 (3.86)	.185 (4.70)	.954 (24.23)	.719 (18.26)	.125 (3.18)
12	.751 (19.08)	.808 (20.52)	.667 (16.94)	.859 (21.82)	.152 (3.86)	.185 (4.70)	1.047 (26.59)	.812 (20.62)	.125 (3.18)
14	.876 (22.25)	.935 (23.75)	.791 (20.09)	.984 (24.99)	.152 (3.86)	.185 (4.70)	1.141 (28.98)	.906 (23.01)	.125 (3.18)
16	1.001 (25.42)	1.058 (26.87)	.916 (23.27)	1.108 (28.14)	.152 (3.86)	.185 (4.70)	1.234 (31.24)	.969 (24.61)	.125 (3.18)
18	1.126 (28.60)	1.183 (30.05)	1.034 (31.34)	1.233 (31.32)	.152 (3.86)	.185 (4.70)	1.328 (33.73)	1.062 (26.97)	.125 (3.18)
20	1.251 (31.77)	1.308 (33.22)	1.158 (34.52)	1.358 (34.49)	.179 (4.55)	.185 (4.70)	1.453 (36.91)	1.156 (29.36)	.125 (3.18)
22	1.376 (34.95)	1.433 (36.40)	1.283 (32.59)	1.483 (37.67)	.179 (4.55)	.185 (4.70)	1.578 (40.08)	1.250 (31.75)	.125 (3.18)
24	1.501 (38.13)	1.568 (39.83)	1.408 (35.76)	1.610 (40.89)	.169 (4.29)	.185 (4.70)	1.703 (43.66)	1.375 (34.92)	.152 (3.86)

Box Mounting Receptacle (Back Panel)

No MS part number

KJ5R

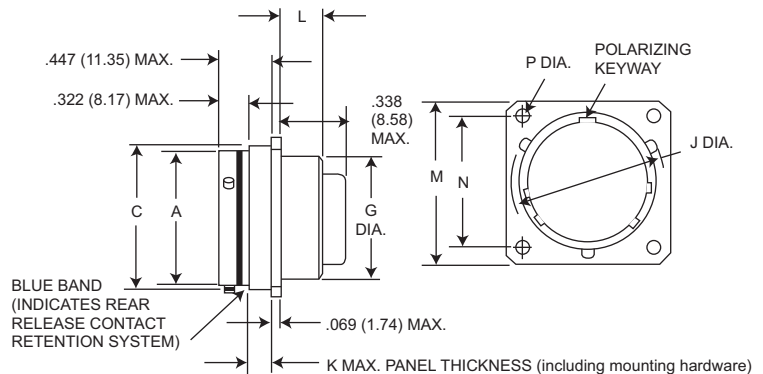

NOTE: This connector does not accommodate backshells

Shell Size	A Dia. Max.	C Dia. Max.	G Dia. Max.	J Dia. Max.	K Max.	L Max.	M Max.	N T.P	P +.005 (0.13) -0.010 (0.25)
8	.474 (12.04)	.522 (13.26)	.421 (10.69)	.563 (14.30)	.147 (3.73)	.185 (4.70)	.828 (21.03)	.594 (15.09)	.125 (3.18)
10	.591 (15.01)	.639 (16.23)	.542 (13.77)	.680 (17.27)	.152 (3.86)	.185 (4.70)	.954 (24.23)	.719 (18.26)	.125 (3.18)
12	.751 (19.08)	.808 (20.52)	.667 (16.94)	.859 (21.82)	.152 (3.86)	.185 (4.70)	1.047 (26.59)	.812 (20.62)	.125 (3.18)
14	.876 (22.25)	.935 (23.75)	.791 (20.09)	.984 (24.99)	.152 (3.86)	.185 (4.70)	1.141 (28.98)	.906 (23.01)	.125 (3.18)
16	1.001 (25.42)	1.058 (26.87)	.916 (23.27)	1.108 (28.14)	.152 (3.86)	.185 (4.70)	1.234 (31.24)	.969 (24.61)	.125 (3.18)
18	1.126 (28.60)	1.183 (30.05)	1.034 (31.34)	1.233 (31.32)	.152 (3.86)	.185 (4.70)	1.328 (33.73)	1.062 (26.97)	.125 (3.18)
20	1.251 (31.77)	1.308 (33.22)	1.158 (34.52)	1.358 (34.49)	.179 (4.55)	.185 (4.70)	1.453 (36.91)	1.156 (29.36)	.125 (3.18)
22	1.376 (34.95)	1.433 (36.40)	1.283 (32.59)	1.483 (37.67)	.179 (4.55)	.185 (4.70)	1.578 (40.08)	1.250 (31.75)	.125 (3.18)
24	1.501 (38.13)	1.568 (39.83)	1.408 (35.76)	1.610 (40.89)	.169 (4.29)	.185 (4.70)	1.703 (43.66)	1.375 (34.92)	.152 (3.86)

Straight Plug

MS27473
(MS service class E, P, T)

KJ6

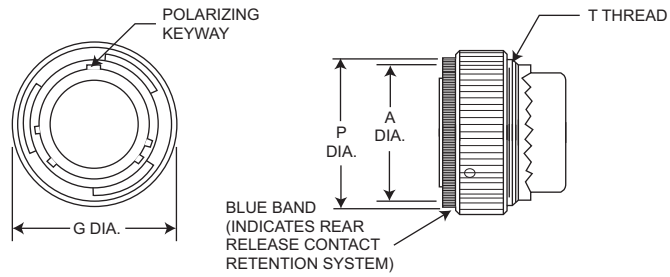

Shell Size	A Dia. Max.	G Dia. Max.	P Dia. Max.	T Thread	Overall Length With Backshells		
					E Straight	F Cable Clamp	P Potting Max.
8	.485 (12.32)	.749 (19.02)	.630 (16.00)	7/16-28UNEF-2A	1.026 (26.06)	1.555 (39.50)	1.020 (25.91)
10	.606 (15.39)	.858 (21.79)	.752 (19.10)	9/16-24UNEF-2A	1.026 (26.06)	1.555 (39.50)	1.020 (25.91)
12	.765 (19.43)	1.030 (26.16)	.925 (23.50)	11/16-24UNEF-2A	1.026 (26.06)	1.555 (39.50)	1.020 (25.91)
14	.890 (22.61)	1.155 (29.34)	1.050 (26.67)	13/16-20UNEF-2A	1.026 (26.06)	1.790 (45.47)	1.020 (25.91)
16	1.014 (25.76)	1.280 (32.51)	1.172 (29.77)	15/16-20UNEF-2A	1.026 (26.06)	1.790 (45.47)	1.020 (25.91)
18	1.140 (28.96)	1.405 (35.69)	1.304 (33.12)	1-1/16-18UNEF-2A	1.026 (26.06)	1.790 (45.47)	1.020 (25.91)
20	1.264 (32.11)	1.530 (38.86)	1.435 (36.45)	1-3/16-18UNEF-2A	1.026 (26.06)	1.790 (45.47)	1.020 (25.91)
22	1.389 (35.28)	1.640 (40.66)	1.560 (39.62)	1-5/16-18UNEF-2A	1.026 (26.06)	1.930 (49.02)	1.020 (25.91)
24	1.514 (38.46)	1.765 (44.83)	1.688 (42.88)	1-7/16-18UNEF-2A	1.104 (28.04)	1.930 (49.02)	1.080 (27.43)

Straight Plug Grounded

MS27484
(MS service class E, P, T)

KJG6

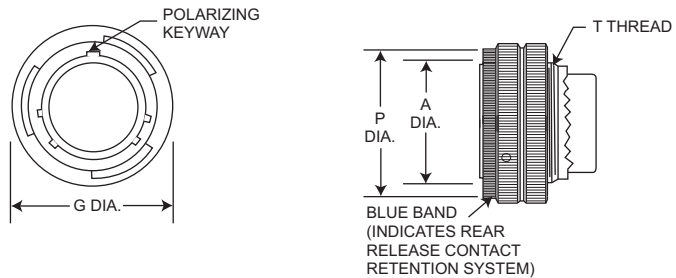

Shell Size	A Dia. Max.	G Dia. Max.	P Dia. Max.	T Thread	Overall Length With Backshells		
					E Straight	F Cable Clamp	P Potting Max.
8	.485 (12.32)	.749 (19.02)	.630 (16.00)	7/16-28UNEF-2A	1.026 (26.06)	1.555 (39.50)	1.020 (25.91)
10	.606 (15.39)	.858 (21.79)	.752 (19.10)	9/16-24UNEF-2A	1.026 (26.06)	1.555 (39.50)	1.020 (25.91)
12	.765 (19.43)	1.030 (26.16)	.925 (23.50)	11/16-24UNEF-2A	1.026 (26.06)	1.555 (39.50)	1.020 (25.91)
14	.890 (22.61)	1.155 (29.34)	1.050 (26.67)	13/16-20UNEF-2A	1.026 (26.06)	1.790 (45.47)	1.020 (25.91)
16	1.014 (25.76)	1.280 (32.51)	1.172 (29.77)	15/16-20UNEF-2A	1.026 (26.06)	1.790 (45.47)	1.020 (25.91)
18	1.140 (28.96)	1.405 (35.69)	1.304 (33.12)	1-1/16-18UNEF-2A	1.026 (26.06)	1.790 (45.47)	1.020 (25.91)
20	1.264 (32.11)	1.530 (38.86)	1.435 (36.45)	1-3/16-18UNEF-2A	1.026 (26.06)	1.790 (45.47)	1.020 (25.91)
22	1.389 (35.28)	1.640 (40.66)	1.560 (39.62)	1-5/16-18UNEF-2A	1.026 (26.06)	1.930 (49.02)	1.020 (25.91)
24	1.514 (38.46)	1.765 (44.83)	1.688 (42.88)	1-7/16-18UNEF-2A	1.104 (28.04)	1.930 (49.02)	1.080 (27.43)



Dimensions shown in mm
Specifications and dimensions subject to

www.ittcannon.com

Jam Nut Receptacle

MS27474
(MS service class E, P, T)

KJ7

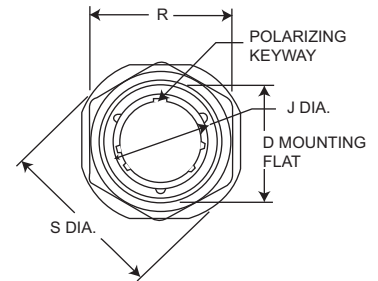
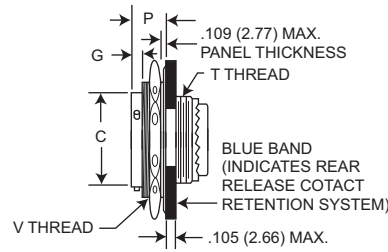

Shell Size	C Dia. Max.	D Max.	G Max.	J Max.	P Max.	R Max. Hex.	S Dia. Max.	T Thread	V Thread	Overall length With Backshells		
										E Straight	F Cable Clamp	P Potting Max.
8	.474 (12.04)	.818 (20.78)	.145 (3.68)	.563 (14.30)	.443 (11.25)	1.079 (27.41)	1.381 (35.08)	7/16-28UNEF-2A	7/8-20UNEF-2A	.840 (21.34)	1.555 (39.50)	1.020 (25.91)
10	.591 (15.01)	.942 (23.93)	.145 (3.68)	.680 (17.27)	.443 (11.25)	1.205 (30.61)	1.506 (38.25)	9/16-24UNEF-2A	1-20UNEF-2A	.840 (21.34)	1.555 (39.50)	1.020 (25.91)
12	.751 (19.08)	1.066 (27.08)	.145 (3.68)	.859 (21.82)	.443 (11.25)	1.329 (33.76)	1.631 (41.43)	11/16-24UNEF-2A	1-1/8-18UNEF-2A	.840 (21.34)	1.555 (39.50)	1.020 (25.91)
14	.876 (22.25)	1.191 (30.25)	.145 (3.68)	.984 (24.99)	.443 (11.25)	1.455 (36.96)	1.756 (44.60)	13/16-20UNEF-2A	1-1/4-18UNEF-2A	.840 (21.34)	1.790 (45.47)	1.020 (25.91)
16	1.001 (25.43)	1.321 (33.55)	.145 (3.68)	1.108 (28.14)	.443 (11.25)	1.579 (40.11)	1.944 (49.38)	1-15/16-20UNEF-2A	1-3/8-18UNEF-2A	.840 (21.34)	1.790 (45.47)	1.020 (25.91)
18	1.126 (28.60)	1.441 (36.60)	.145 (3.68)	1.233 (31.32)	.443 (11.25)	1.705 (43.31)	2.022 (51.36)	1-1/16-18UNEF-2A	1-1/2-18UNEF-2A	.840 (21.34)	1.790 (45.47)	1.020 (25.91)
20	1.251 (31.78)	1.566 (39.78)	.171 (4.34)	1.358 (34.49)	.469 (11.91)	1.829 (46.46)	2.147 (54.53)	1-3/16-18UNEF-2A	1-5/8-18UNEF-2A	.840 (21.34)	1.790 (45.47)	1.020 (25.91)
22	1.376 (33.95)	1.691 (42.95)	.171 (4.34)	1.483 (37.67)	.469 (11.91)	2.017 (51.23)	2.271 (57.68)	1-5/16-18UNEF-2A	1-3/4-18UNEF-2A	.840 (21.34)	1.930 (49.02)	1.020 (25.91)
24	1.501 (38.13)	1.816 (46.13)	.171 (4.34)	1.610 (40.89)	.469 (11.91)	2.142 (54.41)	2.396 (60.86)	1-7/16-18UNEF-2A	1-7/8-18UNEF-2A	.860 (21.84)	1.900 (48.26)	1.080 (27.43)

Panel Cutouts

Flange Mounted Receptacle

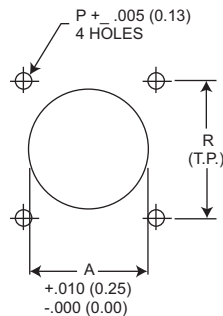

Shell Size	A Dia.	P Dia.	R	Mfg. Screw
8	.610 (15.49)	.125 (3.18)	.594 (15.09)	#4
10	.734 (18.64)	.125 (3.18)	.719 (18.26)	#4
12	.860 (21.84)	.125 (3.18)	.812 (20.62)	#4
14	.985 (25.02)	.125 (3.18)	.906 (23.01)	#4
16	1.110 (28.19)	.125 (3.18)	.969 (24.61)	#4
18	1.234 (31.34)	.125 (3.18)	1.062 (26.97)	#4
20	1.360 (35.54)	.125 (3.18)	1.156 (29.36)	#4
22	1.484 (37.69)	.125 (3.18)	1.250 (31.75)	#4
24	1.611 (40.92)	.152 (3.86)	1.375 (34.93)	#6

Jam Nut Receptacle

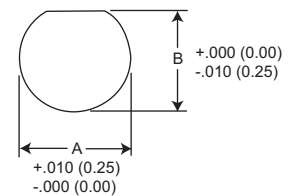

Shell Size	A Dia.	B Dia.
8	.885 (22.48)	.830 (21.08)
10	1.010 (25.65)	.955 (24.26)
12	1.135 (28.82)	1.085 (27.56)
14	1.260 (32.00)	1.210 (30.73)
16	1.385 (35.18)	1.335 (33.91)
18	1.510 (38.35)	1.460 (37.08)
20	1.635 (41.53)	1.585 (40.26)
22	1.760 (44.70)	1.710 (43.43)
24	1.885 (47.88)	1.835 (46.61)

Dimensions shown in mm
Specifications and dimensions subject to
www.ittcannon.com



How to Order:

ITT Nomenclature



SERIES PREFIX

KJ - Series II - Low Profile

SHELL STYLE

- 0 - Wall mounting receptacle
- 2 - Box mounting receptacle
- 3 - Wall mounting receptacle (back panel mounting)
- 4 - Thru Bulkhead receptacle
- 5 - Box mounting receptacle (back panel mounting)
- 6 - Straight plug
- G6 - Straight plug, grounded
- 7 - Jam nut receptacle

CLASS

- E - Environment - resistant with rear accessory (without strain relief)
- F - Environment - resistant with strain relief accessory
- G - Environment-resistant wall mount and jam nut receptacle and plug types. Space Grade (Finish N Only, Modification code not required)
- P - Environment - resistant with straight potting cup accessory
- R - Environment - resistant with full grommet seal without rear accessory; shell styles 2 and 5 only
- T - Environment - resistant (without rear accessory). (Class T not applicable to KJ2E, KJ2R, KJ5E and KJ5R.)

Note KJ supplied with exact complement of contacts.

SHELL SIZE

8, 10, 12, 14, 16, 18, 20, 22, and 24.

HARDWARE FINISH STANDARD

- A - Bright cadmium over electroless nickel plate, - 85°F to + 302°F (- 65°C to + 150°C)
- B - Olive drab cadmium over electroless nickel plate, - 85°F to + 347°F (- 65°C to + 175°C)
- N - Electroless nickel, - 85°F to + 392°F (-65°C to + 200°C)

CONTACT ARRANGEMENT

See pages 101 and 102

CONTACT STYLE

- P - Pin
- S - Socket

POLARIZING POSITION

N(normal), A, B, C, D, see page 19.

MODIFICATION CODE

- L - Less contacts, not stamped on connector
- 16 - Outgassed NASA space graded connector
- 27- Outgassed, standard connector



Wall Mount Receptacle

D38999/20

KJA0T**

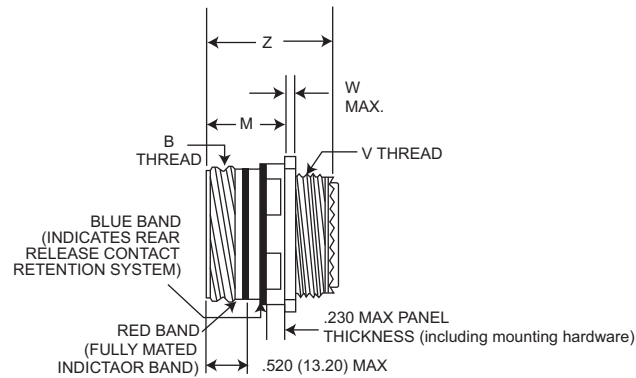
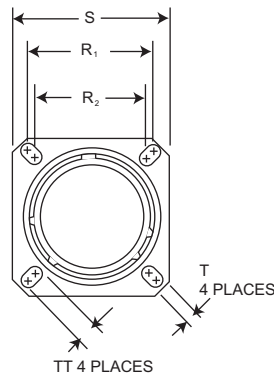

Shell Size	MS Shell size Code	B Thread Class 2A (Plated)	M +.000 (.000) -.005 (.130)	R 1	R 2	S +.012 (.300)	T +.004 (.100) -.002 (.050)	TT +.004 (.100) -.002 (.050)	Metric V Thread (Plated)	W Max.	Z +.005 (.130) -.010 (.250)
9	A	.6250-0.1P-0.3L-TS	.820 (20.83)	.719 (18.26)	.594 (15.09)	.938 (23.83)	.128 (3.25)	.216 (5.49)	M12X1-6g0.100R	.098 (2.50)	1.235 (31.36)
11	B	.7500-0.1P-0.3L-TS	.820 (20.83)	.812 (20.62)	.719 (18.26)	1.031 (26.19)	.128 (3.25)	.194 (4.93)	M15X1-6g0.100R	.098 (2.50)	1.235 (31.36)
13	C	.8750-0.1P-0.3L-TS	.820 (20.83)	.906 (23.01)	.812 (20.62)	1.125 (28.58)	.128 (3.25)	.194 (4.93)	M18X1-6g0.100R	.098 (2.50)	1.235 (31.36)
15	D	1.0000-0.1P-0.3L-TS	.820 (20.83)	.969 (24.61)	.906 (23.01)	1.219 (30.96)	.128 (3.25)	.173 (4.39)	M22X1-6g0.100R	.098 (2.50)	1.235 (31.36)
17	E	1.1875-0.1P-0.3L-TS	.820 (20.83)	1.062 (26.97)	.969 (24.61)	1.312 (33.32)	.128 (3.25)	.194 (4.93)	M25X1-6g0.100R	.098 (2.50)	1.235 (31.36)
19	F	1.2500-0.1P-0.3L-TS	.820 (20.83)	1.156 (29.36)	1.062 (26.97)	1.438 (36.53)	.128 (3.25)	.194 (4.93)	M28X1-6g0.100R	.098 (2.50)	1.235 (31.36)
21	G	1.3750-0.1P-0.3L-TS	.790 (20.07)	1.250 (31.75)	1.156 (29.36)	1.562 (39.67)	.128 (3.25)	.194 (4.93)	M31X1-6g0.100R	.126 (3.20)	1.235 (31.36)
23	H	1.5000-0.1P-0.3L-TS	.790 (20.07)	1.375 (34.92)	1.250 (31.75)	1.688 (42.88)	.154 (3.91)	.242 (6.15)	M34X1-6g0.100R	.126 (3.20)	1.235 (31.36)
25	J	1.6250-0.1P-0.3L-TS	.790 (20.07)	1.500 (38.10)	1.375 (34.92)	1.812 (46.02)	.154 (3.91)	.242 (6.15)	M37X1-6g0.100R	.126 (3.20)	1.235 (31.36)

Straight Plug Grounded

D38999/26

KJA6T**

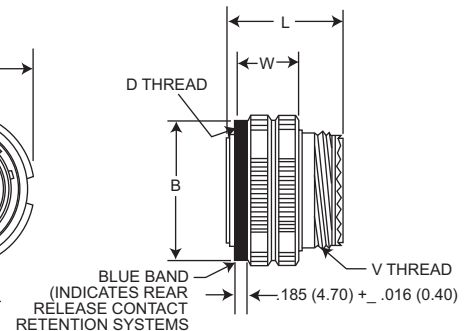
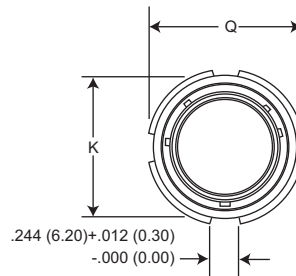

Shell Size	MS Shell size Code	B +.008 (.200) -.000 (.000)	D Thread Class 2B (Plated)	K Max.	L Max.	Q Dia Max.	Metric V Thread (Plated)	W +.008 (.200) -.004 (.100)
9	A	.724 (18.40)	.6250-0.1P-0.3L-TS	.748 (19.00)	1.234 (31.34)	.859 (21.82)	M12X1-6g0.100R	.760 (19.30)
11	B	.831 (21.10)	.7500-0.1P-0.3L-TS	.862 (21.90)	1.234 (31.34)	.969 (24.61)	M15X1-6g0.100R	.760 (19.30)
13	C	1.000 (25.40)	.8750-0.1P-0.3L-TS	1.027 (26.10)	1.234 (31.34)	1.141 (28.98)	M18X1-6g0.100R	.760 (19.30)
15	D	1.130 (28.70)	1.0000-0.1P-0.3L-TS	1.153 (29.30)	1.234 (31.34)	1.266 (32.16)	M22X1-6g0.100R	.760 (19.30)
17	E	1.268 (32.20)	1.1875-0.1P-0.3L-TS	1.291 (32.80)	1.234 (31.34)	1.391 (35.53)	M25X1-6g0.100R	.760 (19.30)
19	F	1.374 (34.90)	1.2500-0.1P-0.3L-TS	1.398 (35.50)	1.234 (31.34)	1.500 (38.10)	M28X1-6g0.100R	.760 (19.30)
21	G	1.500 (38.10)	1.3750-0.1P-0.3L-TS	1.524 (38.70)	1.234 (31.34)	1.625 (41.28)	M31X1-6g0.100R	.760 (19.30)
23	H	1.618 (41.40)	1.5000-0.1P-0.3L-TS	1.642 (41.70)	1.234 (31.34)	1.750 (44.45)	M34X1-6g0.100R	.760 (19.30)
25	J	1.744 (44.30)	1.6250-0.1P-0.3L-TS	1.768 (44.90)	1.234 (31.34)	1.875 (47.62)	M37X1-6g0.100R	.760 (19.30)

Dimensions shown in mm
Specifications and dimensions subject to
www.ittcannon.com



Jam Nut Receptacle

D38999/24

KJA7T***

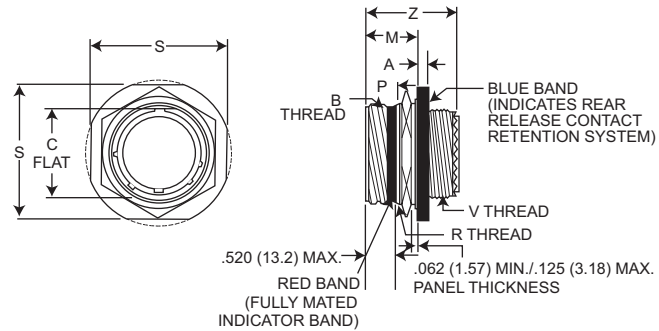

Shell Size	MS Shell Code	A +.010 (.25) -.005 (.130)	B Thread Class 2A (Plated)	C +.004 (.100) -.010 (.250)	Z +.005 (.130) -.040 (.100)	M +.005 (.130) -.004 (.100)	P +.016 (.410) -.004 (.100)	S	Metric R Thread (Plated)	Metric V Thread (Plated)
9	A	.104 (2.64)	.6250-0.1P-0.3L-TS	.651 (16.53)	1.243 (31.57)	.871 (22.12)	.555 (14.10)	1.062 (26.97)	M17X1-6g0.100R	M12X1-6g0.100R
11	B	.104 (2.64)	.7500-0.1P-0.3L-TS	.751 (19.07)	1.243 (31.57)	.871 (22.12)	.555 (14.10)	1.250 (31.75)	M20X1-6g0.100R	M15X1-6g0.100R
13	C	.104 (2.64)	.8750-0.1P-0.3L-TS	.938 (23.82)	1.243 (31.57)	.878 (22.30)	.563 (14.30)	1.375 (34.92)	M25X1-6g0.100R	M18X1-6g0.100R
15	D	.104 (2.64)	1.0000-0.1P-0.3L-TS	1.062 (26.97)	1.243 (31.57)	.878 (22.30)	.563 (14.30)	1.500 (38.10)	M28X1-6g0.100R	M22X1-6g0.100R
17	E	.104 (2.64)	1.1875-0.1P-0.3L-TS	1.187 (30.15)	1.243 (31.57)	.878 (22.30)	.563 (14.30)	1.625 (41.28)	M32X1-6g0.100R	M25X1-6g0.100R
19	F	.135 (3.43)	1.2500-0.1P-0.3L-TS	1.312 (33.32)	1.243 (31.57)	.878 (22.30)	.563 (14.30)	1.812 (46.02)	M35X1-6g0.100R	M28X1-6g0.100R
21	G	.135 (3.43)	1.3750-0.1P-0.3L-TS	1.437 (36.50)	1.243 (31.57)	.878 (22.30)	.563 (14.30)	1.938 (49.23)	M38X1-6g0.100R	M31X1-6g0.100R
23	H	.135 (3.43)	1.5000-0.1P-0.3L-TS	1.562 (39.67)	1.243 (31.57)	.878 (22.30)	.563 (14.30)	2.062 (52.37)	M41X1-6g0.100R	M34X1-6g0.100R
25	J	.135 (3.43)	1.6250-0.1P-0.3L-TS	1.687 (42.85)	1.243 (31.57)	.878 (22.30)	.563 (14.30)	2.188 (55.38)	M44X1-6g0.100R	M37X1-6g0.100R

Panel Cutouts

Wall Mounted Receptacle

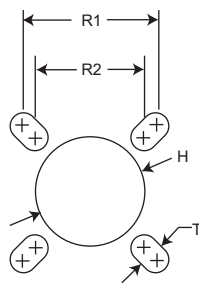

Jam Nut Receptacle

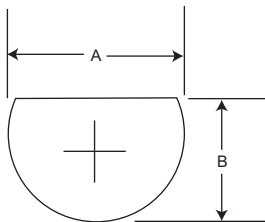

Shell Size	A +.010 (.25) -.000 (.00)	B +.000 (.00) -.010 (.25)	H +.010 (.25) -.000 (.00)	R1 (TP)	R2 (TP)	T (Max.)
9	.700 (17.78)	.670 (17.02)	.626 (15.90)	.719 (18.26)	.594 (15.09)	.134 (3.40)
11	.825 (20.96)	.771 (19.58)	.751 (19.08)	.812 (20.62)	.719 (18.26)	.134 (3.40)
13	1.010 (25.65)	.955 (24.26)	.876 (22.25)	.906 (23.01)	.812 (20.62)	.134 (3.40)
15	1.135 (28.83)	1.085 (27.56)	1.001 (25.43)	.969 (24.61)	.906 (23.01)	.134 (3.40)
17	1.260 (32.00)	1.210 (30.73)	1.188 (30.18)	1.062 (26.97)	.969 (24.61)	.134 (3.40)
19	1.385 (35.18)	1.335 (33.91)	1.251 (31.78)	1.156 (29.36)	1.062 (26.97)	.134 (3.40)
21	1.510 (38.35)	1.460 (37.08)	1.376 (34.95)	1.250 (31.75)	1.156 (29.36)	.134 (3.40)
23	1.635 (41.53)	1.585 (40.26)	1.511 (38.38)	1.375 (34.92)	1.250 (31.75)	.160 (4.06)
25	1.760 (44.70)	1.710 (43.43)	1.626 (41.30)	1.500 (38.10)	1.375 (34.92)	.160 (4.06)



How to Order:

Cannon Nomenclature

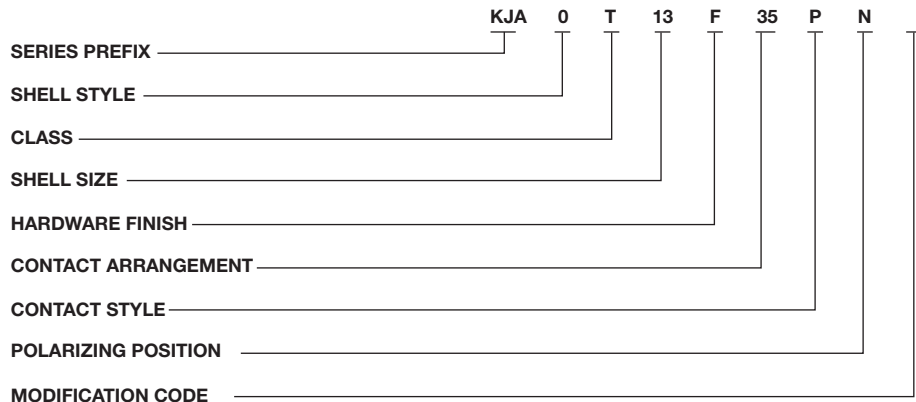

SHELL SIZE

9	11	13	15	17	19	21	23	25	Cannon Designation
A	B	C	D	E	F	G	H	J	

HARDWARE FINISH

- F - Electroless nickel, - 85°F to +392°F (-65°C to +200°C)
- G - Electroless nickel plated Space Grade (Modification code not required)
- W - Olive drab cadmium over electroless nickel plate, -85°F to +347°F (-65°C to +175°C)

CONTACT ARRANGEMENTS

See Pages

CONTACT STYLE

- P - Pin contacts
- S - Socket contacts

POLARIZING POSITION

N (normal) A, B, C, D, E

MODIFICATION CODE

- L - Less contacts, not stamped on connector
- 16 - Outgassed NASA space graded connector
- 27 - Outgassed, standard connector

SERIES PREFIX

KJA - Series III - Scoop proof, threaded coupling

SHELL STYLE

- 0 - Wall mount receptacle
- 6 - Straight plug
- 7 - Jam nut receptacle

CLASS

T - Environment-resistant (without rear accessory)

Polarizing Positions

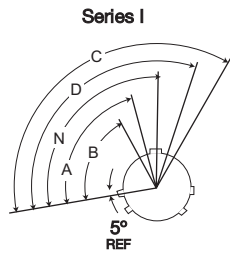

Front face of receptacle (plug opposite). Insert arrangement does not rotate with main key-keyway. The master key is rotated to provide shell polarization; the minor keys remain fixed.

Shell Size	Angle of Rotation (Degrees)				
	Normal	A	B	C	D
9	95°	77°			
11	95°	81°	67°	123°	
13	95°	75°	63°	127°	
15	95°	74°	61°	129°	
17	95°	77°	65°	125°	
19	95°	77°	65°	125°	
21	95°	77°	65°	125°	
23	95°	80°	69°	121°	
25	95°	80°	69°	121°	

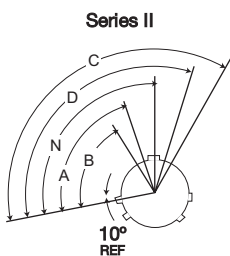

Front face of receptacle (plug opposite). Insert arrangement does not rotate with main key-keyway. The master key is rotated to provide shell polarization; the minor keys remain fixed.

Shell Size	Angle of Rotation (Degrees)				
	Normal	A	B	C	D
8	100°	82°			
10	100°	86°	72°	128°	
12	100°	80°	68°	132°	
14	100°	79°	66°	134°	
16	100°	82°	70°	130°	
18	100°	82°	70°	130°	
20	100°	82°	70°	130°	
22	100°	85°	74°	126°	
24	100°	85°	74°	126°	

Series III

RECEPTACLE
(Front face shown)

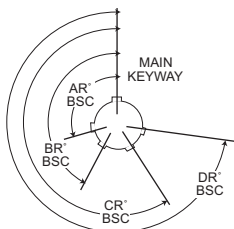

PLUG
(Front face shown)

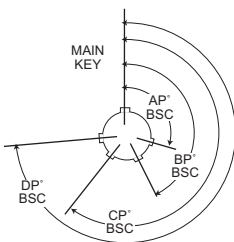

NOTES

- All Angles are BSC
- The insert arrangement does not rotate with main key/keyway
- All minor keys are rotated to provide shell polarization, the master key remains fixed at twelve o'clock position.
- Polarization is different from Series I and II.

Shell Size	Key & Keyway Arrangement Identification Letter	Key Locations			
		AR° or AP° BSC	BR° or BP° BSC	CR° or CP° BSC	D
9	N	105	140	215	265
	A	102	132	248	320
	B	80	118	230	312
	C	35	140	205	275
	D	64	155	234	304
11	E	91	131	197	240
	N	95	141	208	236
	A	113	156	182	292
	B	90	145	195	252
	C	53	156	220	255
13 and 15	D	119	146	176	298
	E	51	141	184	242
	N	80	142	196	293
17 and 19	A	135	170	200	310
	B	49	169	200	244
	C	66	140	200	257
	D	62	145	180	280
	E	79	153	197	272
21 and 23	N	80	142	196	293
	A	135	170	200	310
	B	49	169	200	244
	C	66	140	200	257
	D	62	145	180	280
25	E	79	153	197	272



Contact Arrangements (Engaging View Pin Insert)

* Socket insert only

** Pin insert only (Not available in socket insert Series I and III)

Indicates layouts are available in all shell styles including MS27499, MS27508, KJ2E and KJ5E
• Consult factory MS27505E/KJL5E insert availability

Series III	9-98	9-35	-	11-5	11-98	-	11-35	-	-	13-8
Series II	8-98†	8-35†	-	10-5†	10-98†	10-99†	10-35†	12-3	12-4†	12-8†
Series I	9-98	9-35	11-4	11-5	11-98	11-99	11-35	-	13-4**	13-8
No. of Contacts	3 #20	6 #22D	4 #20	5 #20	6 #20	7 #20	13 #22D	3 #16	4 #16	8 #20
Service Ratings	I	M	I	I	I	I	M	II	I	I

Series III	13-98	13-35	15-5	15-15	15-18	15-19	15-35
Series II	12-98†	12-35†	14-5†	14-15†	14-18†	-	14-35†
Series I	13-98	13-35	15-5	15-15	15-18	15-19	15-35
No. of Contacts	10 #20	22 #22D	5 #16	14 #20, 1 #16	18 #20	19 #20	37 #22D
Service Ratings	I	M	II	I	I	I	M

Series III	15-97	17-6	17-8	17-26	17-35	-	-
Series II	14-97†	16-6	16-8†	16-26†	16-35†	16-42†	16-99†
Series I	15-97	17-6	17-8	17-26	17-35	42 #22	17-99**
No. of Contacts	8 #20, 4 #16	6 #12	8 #16	26 #20	55 #22D	M	21 #20, 2 #16
Service Ratings	I	I	II	I	M	M	I

Series III	-	-	19-11	19-32	19-35
Series II	18-28	18-30	18-11	18-32†	18-35†
Series I	19-28**	19-30**	19-11	19-32	19-35
No. of Contacts	26 #20, 2 #16	29 #20, 1 #16	11 #16	32 #20	66 #22D
Service Ratings	I	I	II	I	M

Series III	21-11	21-16	21-35	21-39	21-41
Series II	-	20-16†	20-35†	20-39†	20-41†
Series I	21-11	21-16	21-35	21-39	21-41
No. of Contacts	11 #12	16 #16	79 #22D	37 #20, 2 #16	41- #20
Service Ratings	I	II	M	I	I

Series III	21-75	23-21	-	23-35
Series II	-	22-21	22-32	22-35†
Series I	21-75*	23-21	23-32**	23-35
No. of Contacts	4 #8 Twinax	21 #16	32 #20	100 #22D
Service Ratings	M	II	I	M

Please consult factory for availability of layouts not shown.

Dimensions shown in mm

Specifications and dimensions subject to

www.ittcannon.com



Contact Arrangements (Engaging View Pin Insert)

* Socket insert only

** Pin insert only (Not available in socket insert Series I and III)

† Indicates layouts are available in all shell styles including MS27499, MS27508, KJ2E and KJ5E

• Consult factory for MS27505E/KJL5E insert availability

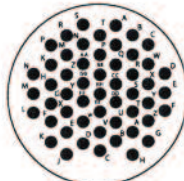

Series III
Series II
Series I
No. of Contacts
Service Ratings

23-53
22-53†
23-53
53 #20
I

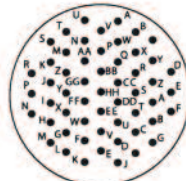

23-55
22-55†
23-55
55 #20
I

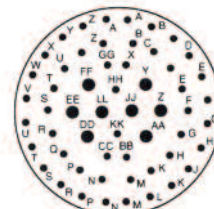

25-4
24-4†
25-4
48 #20, 8 #16
I

Series III
Series II
Series I
No. of Contacts
Service Ratings

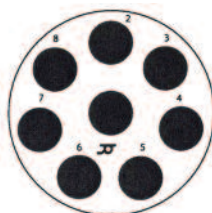

Series III
Series II
Series I
No. of Contacts
Service Ratings

25-8
-
25-8*
8 #8 Twinax
Twinax

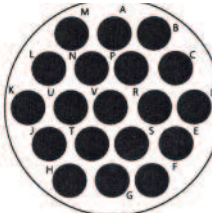

25-19
-
25-19
19 #12
I

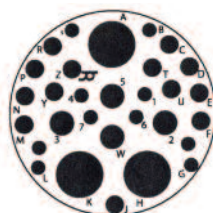

25-20
-
25-20*
3 #8 Twinax, 13 #16,
4 #12 Coax, 10 #20
N / Coax / Twinax

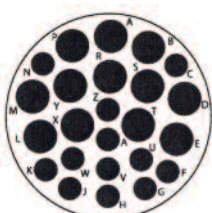

25-24
24-24†
25-24
12 #16, 12 #12
I

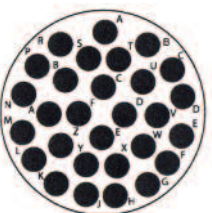

25-29
24-29†
25-29
29 #16
I

Series III
Series II
Series I
No. of Contacts
Service Ratings

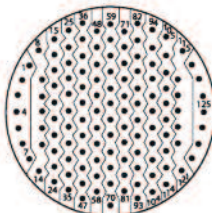

Series III
Series II
Series I
No. of Contacts
Service Ratings

25-35
24-35†
25-35
128 #22D
M

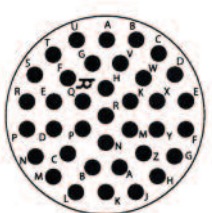

25-37
-
25-37*
37 #16
I

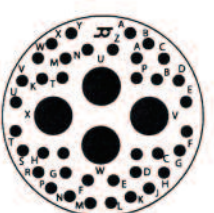

25-42
-
25-42*
38 #20, 4 #8 Coax
I, Coax

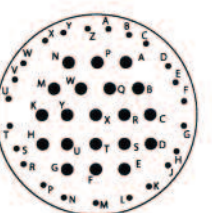

25-43
-
25-43
23 #20, 20 #16
I

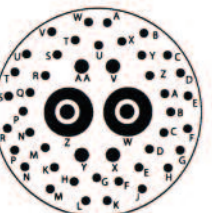

25-46
-
25-46
40 #20, 4 #16, 2 #8
Twinax

Series III
Series II
Series I
No. of Contacts
Service Ratings

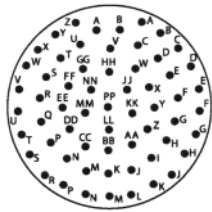

Series III
Series II
Series I
No. of Contacts
Service Rating

25-61
24-61†
25-61
61 #20
I

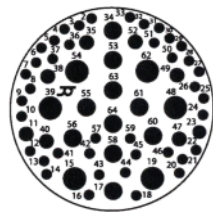

25-64*
-
25-64*
40 #22D, 8 #20
10 #16, 6 #12
I

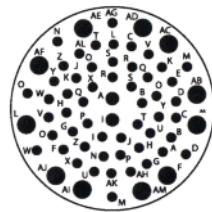

25-66*
-
25-66*
53 #22D, 2 #20, 11 #16
I

Series III
Series II
Series I
No. of Contacts
Service Rating



Contacts-Pin (Series I/II/III)

MIL-C-39029/58

KJL/KJ/KJA

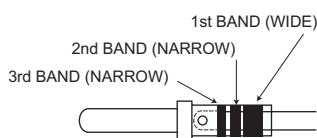

Contact Size	Color Bands			Cannon Part Number	M39029 Military Part Number
	1	2	3		
22D	Orange	Blue	Black	980-0008-878	M39029/58-360
20	Orange	Blue	Orange	980-0008-879	M39029/58-363
16	Orange	Blue	Yellow	980-0008-880	M39029/58-364
12	Orange	Blue	Green	980-0008-881	M39029/58-365

Contact Size	Cannon Part Number	Cable Accommodations
8 Coax	249-2196-000	RG-180
	249-2196-001	RG-174, 179, 316
	249-2196-002	RG-142
8 Twinax	980-1000-012	M17/176-00002
12 Coax	980-1000-016	RG-174, 179, 316

Contacts-Socket (Series II)

MIL-C-39029/57

KJ

Manufacture identification Code Area - Typical

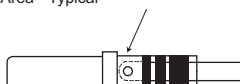

Contact Size	Color Bands			Cannon Part Number	M39029 Military Part Number
	1	2	3		
22D	Orange	Green	Yellow	980-0008-874	M39029/57-354
20	Orange	Green	Violet	980-0008-875	M39029/57-357
16	Orange	Green	Gray	980-0008-876	M39029/57-358
12	Orange	Green	White	980-0008-877	M39029/57-359

Contacts-Socket (Series I & III)

MIL-C-39029/56

KJL/KJA

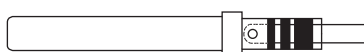

Contact Size	Color Bands			Cannon Part Number	M39029 Military Part Number
	1	2	3		
22D	Orange	Yellow	Gray	980-0008-870	M39029/56-348
20	Orange	Green	Brown	980-0008-871	M39029/56-351
16	Orange	Green	Red	980-0008-872	M39029/56-352
12	Orange	Green	Orange	980-0008-873	M39029/56-353

Contact Size	Cannon Part Number	Cable Accommodations
8 Coax	249-2195-000	RG-180
	249-2195-001	RG-174, 179, 316
	249-2195-002	RG-142
8 Twinax	980-1000-013	M17/176-00002
12 Coax	980-1000-015	RG-174, 179, 316

Wire Sizes and Diameters

Contact Size	Wire size (AWG)	Finished wire outside dimensions	
		Minimum	Maximum
22D	28, 26, 24, 22	0.030	0.054
22M*	28, 26, 24	0.030	0.050
22*	26, 24, 22	0.034	0.060
20	24, 22, 20	0.040	0.083
16	20, 18, 16	0.065	0.109
12	14, 12	0.097	0.142
8 Coax	RG-180	0.136	0.146
8 Twinax	M17/176-00002	0.124	0.134
12 Coax	RG174, 179, 316	0.094	0.102

*For reference only

Recommended Jam Nut Torque Values

Series II		Series I & III	
Shell Size	Inch-Pounds	Shell Size	Inch-Pounds
8	46/50	9	30/36
10	55/60	11	40/46
12	70/75	13	55/60
14	80/85	15	70/75
16	90/95	17	80/85
18	100/110	19	90/95
20	110/120	21	100/110
22	120/130	23	110/120
24	140/150	25	120/130

Coupling Nut Torque Values (Series I, II and III)

Maximum engagement and disengagement		Minimum disengagement	
Shell Size	Inch Pound	Shell Size	Inch Pound
8	8	8	2
9	8	9	2
10	12	10	2
11	12	11	2
12	16	12	2
13	16	13	2
14	20	14	4
15	20	15	3
16	24	16	4
17	24	17	3
18	28	18	5
19	28	19	3
20	32	20	6
21	32	21	5
22	36	22	7
23	36	23	5
24	36	24	7
25	40	25	5

Backshell - Type E (Straight), Series II only

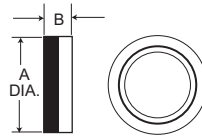

Shell Size		
Series II	A Dia. Max.	B Dia. Max.
8	.580 (14.73)	.328 (8.33)
10	.705 (17.91)	.328 (8.33)
12	.830 (21.08)	.328 (8.33)
14	.955 (24.26)	.328 (8.33)
16	1.080 (27.32)	.328 (8.33)
18	1.205 (30.61)	.328 (8.33)
20	.330 (33.78)	.328 (8.33)
22	1.455 (36.96)	.328 (8.33)
24	1.555 (39.50)	.270 (6.86)

How To Order

Shell Size	Finishes			
	A	B	C	N
Series II	Cadmium/Nickel-Clear Part Number	Cadmium/Nickel-O.D Part Number	Anodic Non-Cond. Part Number	Electroless Nickel Part Number
8	057-0776-000	057-0862-000	057-0819-000	057-0776-002
10	057-0777-000	057-0863-000	057-0820-000	057-0777-002
12	057-0778-000	057-0864-000	057-0821-000	057-0778-002
14	057-0779-000	057-0846-000	057-0822-000	057-0779-002
16	057-0780-000	057-0847-000	057-0823-000	057-0780-002
18	057-0781-000	057-0848-000	057-0824-000	057-0781-002
20	057-0782-000	057-0849-000	057-0825-000	057-0782-002
22	057-0783-000	057-0850-000	057-0826-000	057-0783-002
24	057-0784-000	057-0851-000	057-0827-000	057-0784-002

Backshell - Type F (Cable Clamp)

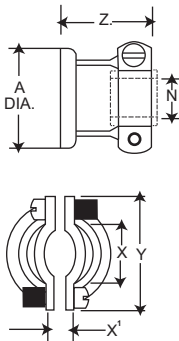

Shell Size		Finishes						
Series I	Series II	A Max.	N Dia. Max.	X Dia. Min.	X ¹ Dia. Min.	Y Max.	Z Max.	
9	8	.508 (14.73)	.135 (3.43)	.234 (5.94)	.187 (4.75)	.829 (21.06)	.813 (20.65)	
11	10	.705 (17.91)	.198 (5.03)	.297 (7.54)	.187 (4.75)	.891 (22.63)	.813 (20.65)	
13	12	.830 (21.08)	.322 (7.18)	.422 (10.72)	.281 (7.14)	1.016 (25.81)	.813 (20.65)	
15	14	.955 (24.26)	.385 (9.78)	.547 (12.89)	.325 (8.26)	1.141 (28.98)	.813 (20.65)	
17	16	1.080 (27.43)	.510 (12.95)	.609 (15.47)	.356 (9.04)	1.203 (30.56)	.933 (23.70)	
19	18	1.205 (30.61)	.635 (16.13)	.734 (18.64)	.456 (11.58)	1.469 (37.31)	.933 (23.70)	
21	20	1.330 (33.78)	.635 (16.13)	.734 (18.64)	.519 (13.18)	1.469 (37.31)	.933 (23.70)	
23	22	1.455 (36.96)	.760 (19.30)	.922 (23.42)	.519 (13.18)	1.656 (42.06)	.933 (23.70)	
25	24	1.555 (39.50)	.810 (20.57)	.984 (24.99)	.657 (16.69)	1.750 (44.45)	.893 (22.68)	

How To Order (MS Version)

MS27506 - A - 8 - 2

Military Designation
MS27506 Type F Straight with Cable Clamp

Finish
A - Cad/Nickel (Clear)
B - Cad/Nickel (O.D)
F - Nickel (Electroless)

Shell Size
Series I - 9, 11, 13, 15, 17, 19, 21, 23, 25
Series II - 8, 10, 12, 14, 16, 18, 20, 22, 24

Adapter
Geometry - 2

Shell Size		Finishes								
Series I	Series II	MS Part Number	Cannon Part Number	Cannon	B			F		
					A	MS	Cannon	MS	Cannon	MS
9	8	27506*8-2	057-3005-***	-012	A		-013	B	-015	F
11	10	27506*10-2	057-3006-***	-011	A		-012	B	-014	F
13	12	27506*12-2	057-3007-***	-012	A		-013	B	-015	F
15	14	27506*14-2	057-3008-***	-010	A		-011	B	-013	F
17	16	27506*16-2	057-3009-***	-012	A		-013	B	-015	F
19	18	27506*18-2	057-3010-***	-013	A		-014	B	-016	F
21	20	27506*20-2	057-3011-***	-011	A		-013	B	-015	F
23	22	27506*22-2	057-3012-***	-015	A		-016	B	-018	F
25	24	27506*24-2	057-3013-***	-013	A		-014	B	-017	F

* MS Finish *** Cannon Finish

Backshell - Type P (Potting Boot)

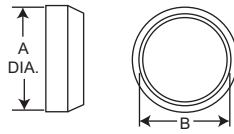

Shell Size		A Dia. Max.	B Dia. Max.
Series I	Series II		
9	8	.598 (15.19)	.434 (11.02)
11	10	.723 (18.36)	.548 (13.92)
13	12	.847 (21.51)	.673 (17.09)
15	14	.969 (24.61)	.798 (20.27)
17	16	1.087 (27.61)	.899 (22.83)
19	18	1.211 (30.76)	1.024 (26.01)
21	20	1.336 (33.93)	1.141 (29.98)
23	22	1.461 (37.11)	1.274 (32.36)
25	24	1.586 (40.28)	1.399 (35.53)

How To Order (MS Version)

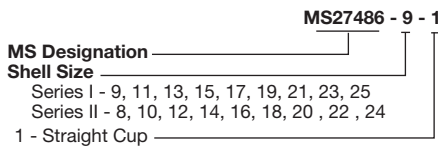

NOTE: When ordering the MS version you must specify both MS numbers for the Potting Boot and the Adapter Ring.

Shell Size		MS27486 Part Number	Cannon Part Number
Series I	Series II		
9	8	27486-**-1	040-0185-000
11	10	27486-**-1	040-0169-000
13	12	27486-**-1	040-0170-000
15	14	27486-**-1	040-0171-000
17	16	27486-**-1	040-0172-000
19	18	27486-**-1	040-0173-000
21	20	27486-**-1	040-0174-000
23	22	27486-**-1	040-0175-000
25	24	27486-**-1	040-0176-000

** Specify applicable Series I or II, shell size.

Potting Boot Adapter Ring

How To Order (MS Version)

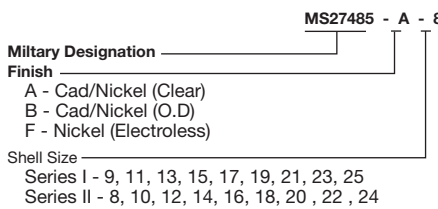

NOTE: When ordering the MS version you must specify both MS numbers for the Potting Boot and the Adapter Ring.

Shell Size		MS27485 Part Number	Cannon Part Number	Finishes					
Series I	Series II			A Cadmium/Nickel		B Cadmium/Nickel-O.D		N Electroless	
				Cannon	MS	Cannon	MS	Cannon	MS
9	8	27485-**-**	237-0887-***	-000	A	-001	B	-002	F
11	10	27485-**-**	237-0874-***	-000	A	-001	B	-002	F
13	12	27485-**-**	237-0875-***	-000	A	-001	B	-002	F
15	14	27485-**-**	237-0876-***	-000	A	-001	B	-002	F
17	16	27485-**-**	237-0877-***	-000	A	-001	B	-002	F
19	18	27485-**-**	237-0878-***	-000	A	-001	B	-002	F
21	20	27485-**-**	237-0879-***	-000	A	-001	B	-002	F
23	22	27485-**-**	237-0880-***	-000	A	-001	B	-003	F
25	24	27485-**-**	237-0881-***	-000	A	-001	B	-003	F

* MS Finish
 ** Specify applicable Series I or II shell size
 *** Cannon Finish

Wire Sealing Plugs

Series III Size	Series I & II Size	Part Number		Color Code
		Cannon	MS27488	
22D	22D	225-1013-000	MS27488-22-1	Black
22M*	22M*	225-1013-000	MS27488-22-1	Black
-	22*	225-1013-000	MS27488-22-1	Black
20	20	225-0070-000	MS27488-20-1	Red
16	16	225-0071-000	MS27488-16-1	Blue
12	12	225-0072-000	MS27488-12-1	Yellow

Wire sealing plugs meet MS27488 standards. The plugs are color coded according to size for easy identification. Wire sealing plugs may be ordered separately.

* For reference only



Tools - Crimp



Contact Size	Pin Contact Series I/II/III		Socket Contact Series II		Socket Contact Series I & III	
	Crimp Tool Part Number	Locator or Turret Part Number	Crimp Tool Part Number	Locator or Turret Part Number	Crimp Tool Part Number	Locator or Turret Part Number
22D or 22M*	M22520/2-01	M22520/2-09	M22520/2-01	M22520/2-06	M22520/2-01	M22520/2-07
22*	M22520/2-01	M22520/2-09	M22520/2-01	M22520/2-06	M22520/2-01	M22520/2-07
20	M22520/1-01	M22520/1-04 OR TH 187	M22520/1-01	M22520/1-04	M22520/1-01	M22520/1-04
16	M22520/1-01	M22520/1-04 OR TH 187	M22520/1-01	M22520/1-04	M22520/1-01	M22520/1-04
12	M22520/1-01	M22520/1-04	M22520/1-01	M22520/1-04	M22520/1-01	M22520/1-04
8 Coax Inner Conductor	Crimp Tool	Crimp Tool Locator	Outer Conductor		Crimp Tool	Crimp Tool Locator
RG180	M22520/2-01	995-002-268-268	RG180		M22520/2-501	M22520/2-5-39B
RG 174, 179, 310	M22520/2-01	995-002-268-268	RG 174, 179, 310		M22520/2-501	M22520/2-5-37B
RG 142	M22520/2-01	995-002-268-268	RG 142		M22520/2-501	M22520/2-5-19B
12 Coax Inner Conductor	Crimp Tool	Crimp Tool Locator	Outer Conductor		Crimp Tool	Crimp Tool Locator
RG174, 316	M22520/2-01	M22520/2-34	RG174, 316		M22520/31-01	M22520/
8 Twinax	Crimp Tool	Crimp Tool Locator				
Center Contact	M22520/2-01	K709				
Intermediate Contact	M22520/5-01	Y631 Die Closure B				
Outer Contact	M22520/5-01	Y631 Die Closure A				

* For reference only

Tools - Plastic



Insertion/Extraction

Contact Size	Cannon Description	Cannon Part Number	M81969 Part Number	Superseded Military Part Number	Insertion Color Tip	Extraction Color Tip
22D	CIET-22D-01	274-7048-000	M81969/14-01	MS27534-22D	Green	White
22M*	CIET-22D-01	274-7048-000	M81969/14-01	MS27534-22D	Green	White
20	CIET-20-10	274-7001-000	M81969/14-10	MS27534-20	Red	Orange
16	CIET-16-03	274-7002-000	M81969/14-03	MS27534-16	Blue	White
12	CIET-12-04	274-7003-000	M81969/14-04	MS27534-12	Yellow	White
8 Coax/Twinax	CET8-T	323-7004-001	—	—	—	—
12 Coax	CIET-12-04	274-7003-000	M81969/14-04	MS27534-12	Yellow	White

Insertion tool not required for size 8

Tools - Metal (MS)



Insertion



Extraction

Contact Size	Insertion			Extraction			
	MS27495 Part Number	ITT CANNON Part Number	Color Band	MS27495 Part Number	ITT CANNON Part Number	No.1 Color Band	No.2 Color Band
22D OR 22M*	MS27495 A22M	995-0001-718	Black	MS27495 R22M	995-0001-719	Black	White
22*	MS27495 A22	995-0001-720	Brown	MS27495 R22	995-0001-721	Brown	White
20	MS27495 A20	995-0001-716	Red	MS27495 R20	995-0001-717	Red	White
16	MS27495 A16	995-0001-732	Blue	MS27495 R16	995-0001-731	Blue	White

Band No. 1 indicates tool size.

Band No. 2 indicates removal tool.

* For reference only

Dimensions shown in mm

Specifications and dimensions subject to

www.ittcannon.com



Wire Stripping

Strip insulation from end of wire to be crimped. (See table for proper stripping dimensions.) Do not cut ordamage wire strands.

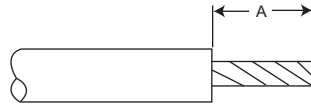

Wire Size	A
22D or 22M*	.125 (3.18)
20	.188 (4.77)
16	.188 (4.77)
12	.188 (4.77)

* For reference only

Contact Crimping

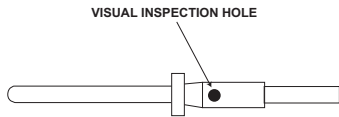

1. Insert stripped wire into contact crimp pot. Wire must be visible thru inspection hole.



2. Using correct crimp tool and locator, cycle the tool once to be sure the indentors are open. Insert contact and wire into locator. Squeeze tool handles firmly and completely to insure a proper crimp. The tool will not release unless the crimp indentors in the tool head have been fully actuated.



3. Release crimped contact and wire from tool. Be certain the wire is visible thru inspection hole in contact.

Contact Insertion



1. Remove hardware from plug or receptacle and slip over wire bundle in proper order for reassembly.



2. Using proper plastic or metal insertion tool for corresponding contact, position wire in tip of the tool so that the tool tip butts up against the contact shoulder.



3. Press tool against contact shoulder and, with firm and even pressure, insert wired contact and tool tip into center contact cavity. A slight click may be heard as metal retaining tines snap into place behind contact shoulder.



4. Remove tool and pull back lightly on wire to make sure contact is properly seated. Repeat operation with remainder of contacts to be inserted, beginning with the center cavity and working outward in alternating rows.



5. After all contacts are inserted, fill any empty cavities with wire sealing plugs, Resemble plug or receptacle hardware.

Contact Extraction

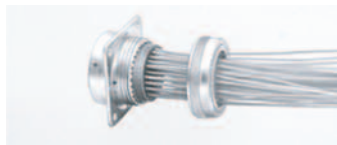

1. Remove hardware from plug or receptacle and slide hardware back along wire bundle.



2. Using plastic or metal extraction tool with proper color code corresponding to contact size, place wire in tool.



3. Insert tool into contact cavity until tool tip bottoms against the contact shoulder, expanding clip retaining tines.



4. Hold wire firmly in tool and extract wired contact and tool. Repeat operation for all contacts to be extracted.



5. Fill any empty wire cavities with wire sealing plugs, and



6. Reassemble plug or receptacle.



Dimensions shown in mm
Specifications and dimensions subject to

www.ittcannon.com

Since 1915, Cannon has been innovating circular connectors beginning with the first "Cannon Plugs." Over 90 years later, ICS continues this tradition with our new "Trinity" line of miniature circular connectors. With this innovative new product line, three truly is a magic number. Bringing a unique combination of Design, Functionality, and Flexibility, the Trinity product line excels in delivering a broad product line tailored directly to extensive VOC. In particular, this product demonstrates its robust design through the inclusion of specific, customer requested technologies including Pogo Pin contacts while delivery these technologies in a small, miniature circular form factor which provides substantial savings in both size and weight. Regarding functionality, Trinity again excels by providing various functional capabilities including threaded coupling, bayonet, and breakaway. Packaging these characteristics together, Trinity provides unparalleled functionality for numerous applications across multiple markets including Industrial, Medical, Aerospace, Military, and Space. Our Trinity product boldly positions itself as a primary resource to tackle your matrix of possibilities.



Product Features

- High contact density: size 23 contacts accommodate #22 - #28 wire and allowing 0.076 inch contact spacing
- Available with 3-85 rear release crimp or PCB contacts
- Master key with 2 secondary keys. 4 clocking positions available
- Significant weight and size reduction compared to traditional Mil Standard environmental connectors
- Available in jam nut, in-line, and square flange rear crimp receptacle versions. Jam nut and square flange PCB receptacle versions
- Rear accessory thread or integral band platform for direct attachment of cable shield or overmold
- Wire seal grommet for rear environmental sealing. Pin fluorosilicone interfacial seal provides interface sealing
- Available with double start threads allowing full mating in 1.5 turns
- Available with quick push/pull breakaway mechanism utilizing canted retention spring for quicker mating and demating
- Available with bayonet 1/4 turn locking mechanism
- Available with Pogo Pin technology utilizing ITT's unique spring probe pin/pad contact system

Applications

- Medical equipment: test and diagnostic
- Industrial equipment
- Commercial and military aircraft electronics
- Unmanned aerial vehicles
- Missile systems
- Avionics systems
- Satellites
- Sensors
- Instrumentation
- Interconnection for helmets, weapons, battery packs, night vision goggles, aircraft headsets, etc.
- Navigation and Telemetry equipment
- Ruggedized computers and hand held communications equipment

Series MKJ Performance	
Contact size / Spacing	#23 / 0.076 inches (1.9 mm)
Contact Type	Rear Crimp or PCB Mount
Wire Accomodation	#22 - #28 AWG
Current Rating	5 Amps Maximum
Voltage Rating	500 VAC RMS Sea Level
Insulation Resistance	5000 Megaohms Minimum
Operating Temperature	-55 degrees C to +150 degrees C
Contact Resistance	8 Milliohms Maximum
Vibration	20 g's in Accordance with MIL-STD-1344 Method 2005, Condition IV
Shock	300 g's (MKJ1) 50 g's (MKJ0 and MKJ4) in Accordance with MIL-STD-1344 Method 2004, Condition E
EMI Shielding Effectiveness	40dB Attenuation, 100 MHz to 1000 MHz
Coupling	Threaded, Quick Disconnect, Pogo Pin
Coding	Master key and 2 secondary keys. 4 clocking positions available
Housing material	Aluminum and Stainless Steel
Layouts	31 layouts holding from 1 size 12 contact to 85 size 23 contacts
Usage	Medical, Military, Commercial, and Industrial
Receptacle Mounting	Jam Nut, Square Flange, In-line, PCB

Dimensions shown in mm
Specifications and dimensions subject to

www.ittcannon.com



MKJ Product Line Talking Dog **MKJ1 — C — 2 — F — 9-19 — P — N — ****

- MKJ1 SERIES**
 MKJ0 - Threaded Coupling, UN Thread
 MKJ1 - Threaded Coupling, Double Start ACME Thread
 MKJ3 - Bayonet Coupling
 MKJ4 - Breakaway/Quick Disconnect
- C CLASS**
 A - Environmental Plug and Receptacle with Banding/Overmolding Platform
 B - Environmental Plug and Receptacle with Threaded Accessory Attachment
 C - Back- Potted Receptacle
- 2 SHELL STYLE**
 1 - In-Line Receptacle
 2 - Square Flange Receptacle
 6 - Straight Plug
 7 - Jam Nut Receptacle
- F MATERIAL/PLATING**
 C - Aluminum/Anodize, Black
 F - Aluminum/Electroless Nickel
 W- Aluminum/OD Cad
 Z - Aluminum/Zinc Nickel, Black
 K - SS/Passivated
 Y - SS/Electroless Nickel, Black
 T - Aluminum/Teflon Nickel
- 9-19 SHELL SIZE/CONTACT ARRANGEMENT**
 5-3 3 Size 23 Contacts Series MKJ0, MKJ1, MKJ2, MKJ3, MKJ4
 6-1 1 Size 16 Contact Series MKJ0, MKJ1, MKJ2, MKJ3, MKJ4
 6-4 4 Size 23 Contacts Series MKJ0, MKJ1, MKJ2, MKJ3, MKJ4
 6-7 7 Size 23 Contacts Series MKJ0, MKJ1, MKJ2, MKJ3, MKJ4
 7-1 1 Size 12 Contact Series MKJ0, MKJ1, MKJ2, MKJ3, MKJ4
 7-10 10 Size 23 Contacts Series MKJ0, MKJ1, MKJ2, MKJ3, MKJ4
 8-13 13 Size 23 Contacts Series MKJ0, MKJ1, MKJ2, MKJ3, MKJ4
 9-4 4 Size 16 Contacts Series MKJ0, MKJ1, MKJ2, MKJ3, MKJ4
 9-19 19 Size 23 Contacts Series MKJ0, MKJ1, MKJ2, MKJ3, MKJ4
 10-26 26 Size 23 Contacts Series MKJ0, MKJ1, MKJ2, MKJ3, MKJ4
 12-2 2 Size 12 Contacts Series MKJ0, MKJ1, MKJ2, MKJ3, MKJ4
 12-37 37 Size 23 Contacts Series MKJ0, MKJ1, MKJ2, MKJ3, MKJ4
 13-2 2 Size 12 Contacts Series MKJ1
 13-37 37 Size 23 Contacts Series MKJ1
 14-55 55 Size 23 Contacts Series MKJ2, MKJ3, MKJ4
 15-55 55 Size 23 Contacts Series MKJ2, MKJ3, MKJ4
 16-55 55 Size 23 Contacts Series MKJ1
 17-85 85 Size 23 Contacts Series MKJ1
- P CONTACT STYLE**
 P - Pin, Crimp, Removable
 S - Socket, Crimp, Removable

 A - Pin, PC Tail, .0.062 Extension
 B - Pin, PC Tail, 0.109 Extension
 C - Socket, PC Tail, 0.062 Extension
 D - Socket, PC Tail, 0.109 Extension
 G - Pin, Pogo, Crimp, Removable
 O - Pad, Pogo, Crimp, Removable
- N SHELL CLOCKING (POSITION)**
MKJ0 Series
 N - Normal
 X - Clocking Position X
 Y - Clocking Position Y
 Z - Clocking Position Z
MKJ1 Series
 A - Normal 150° 210°
 B - Clocking Position B 75° 210°
 C - Clocking Position C 95° 230°
 D - Clocking Position D 140° 275°
MKJ3 Series
 N - Normal 150° 210°
 X - Clocking Position X 75° 210°
 Y - Clocking Position Y 95° 230°
 Z - Clocking Position Z 140° 275°
MKJ4 Series
 Omit for Single Key/Keyway
 A - Normal 150° 210°
 B - Clocking Position B 75° 210°
 C - Clocking Position C 95° 230°
 D - Clocking Position D 140° 275°
- ** MODIFICATION CODES**
 F0 - Less Contacts ("F0" not printed on connector)
 (No modification code required for standard product)
 Consult Factor for other codes



ITT's new light weight Cannon Chip-on-Flex filter connector technology provides a significant performance improvement in thermal shock and vibration. In the new Cannon Chip-on-Flex design, the internal thermal shock stresses have been virtually eliminated. The ceramic planar array capacitor block has been replaced by a flex circuit where individual chip capacitors are surface mounted on a pad adjacent to the feed thru contact. The result is a very robust filter connector with superior mechanical performance and improved reliability. ITT continues to provide current planar array designs as well as offering filter connector versions of Mil-DTL-24308, Mil-C-83513, and Mil-C-26482. For more information, visit www.ittcannon.com/filter

- up to 15% reduction in weight
- meets 25 cycles of thermal shock

Performance and Material Specifications

MATERIALS AND FINISHES

Shell	Aluminum alloy*
Insulator	High grade plastic/epoxy
Contacts	Copper alloy, gold plate
Grommet and Seal	Silicone base elastomer
Jam Nut	Aluminum alloy*
Grounding Spring	Beryllium copper, gold plate

*Finish as noted in How to Order section.

PERFORMANCE

Vibration; Series III

- MIL-STD-1344, Method 2005, Condition VI, Letter J (Random, 8 hrs in 2 axis at high temp)
- MIL-STD-1344, Method 2005, MIL-DTL-38999 Figure 25 (Random, 8 hrs in 2 axis, no weights)

Mechanical Shock

MIL-STD-1344, Method 2004, 300g half sinusoidal shocks

Thermal Shock

MIL-STD-1344, Method 2003, 25 cycles of temperature cycling

ELECTRICAL (Size #16, #20 and #22)

Filter Description	Low Freq.	Mid Freq.	Std. Freq.	High F
Catalog Indicator	L	M	T	H
Voltage Rating	200 VDC - 120 VAC rms 400 Hz			
Current Rating (amp DC)	15 amp - size 16/7.5 amp - size 20/5.0 amp, size 22			
Insulation Resistance, 2 min. electrification time max. at 25°C	5,000 megohms min. @ 100 VDC			
DWV, sea level, with 500 microamps max. charge/discharge	300 VDC size 22	500 VDC		
	500 VDC size 16 & 20			
Capacitance at 1 KHz, 0.1 V rms Picofarads	32,000	8,000	3300	85
	45,000	12,000	5000	1,3
	Freq. MHz			
	0.1	2 min.	-	-
	1	10 min.	2 min.	-
	2	16 min.	7 min.	2 min.
	10	40 min.	18 min.	8 min.
	100	60 min.	55 min.	45 min.
	500 to 1000	60 min.	60 min.	55 min.
				50 n
Filter Type/Construction	Pi	Pi	Pi	Pi

Consult factory for higher or mixed attenuation values and higher voltage ratings.

How to Order - CFKJL/CFKJ/CFKJA/CFKJB

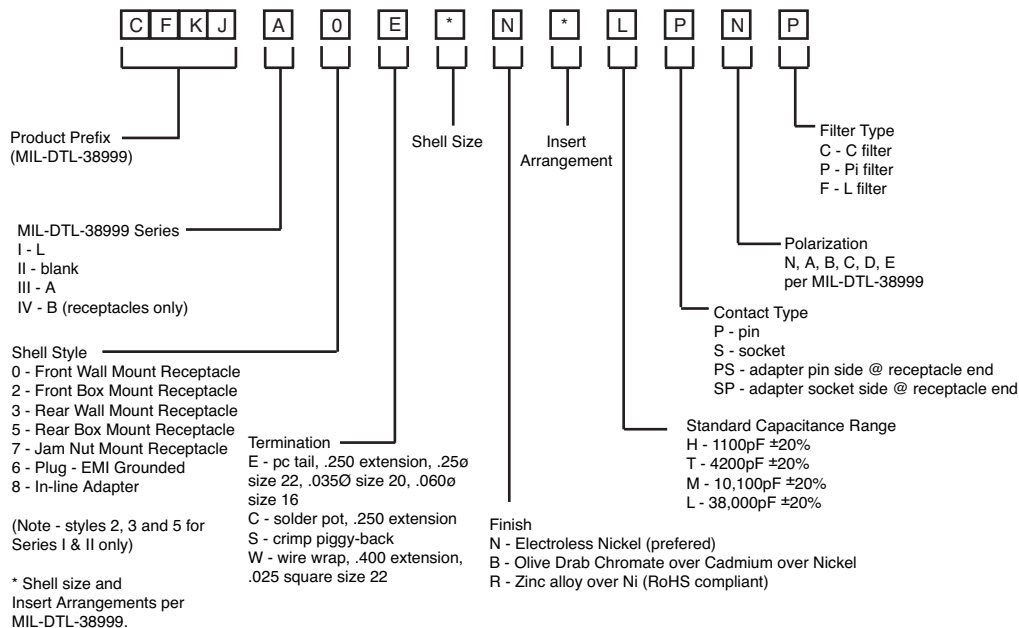

Dimensions shown in mm
Specifications and dimensions subject to
www.ittcannon.com





2.1 Ground Tactical: FOMC / ITAC (MIL-PRF-83526)

The Cannon FOMC and ITAC connector system is offered in two different connector styles with both being considered a field tactical connector and was primarily designed to meet the needs of the military and commercial customers who require a harsh environmental multi-fiber field connector. Both the FOMC and ITAC connectors combines features which provide the user with a connector that will withstand rough handling and weather extremes with features such as elastomeric cable and interface sealing, scoop proof interface to prevent optical contact damage, removable front insert for easy optical contact cleaning, anodized shell finish and a attached dust cap. Both connector series utilize an industry standard physical contact ceramic ferrule assembly, and have an internal fiber chamber for extra fiber storage which eliminates tensile loads from being applied to the terminated fiber and allows for contact re-termination. Another feature is the hermaphroditic design which enables multiple FOMC or ITAC plug or receptacle assemblies to be daisy-chained together in the field.



2.2 FOHC

The Cannon FOHC contact is offered in 2 different alignment styles, a metallic body with ceramic zirconia ferrule tip and a patented metallic body with jewel tip. Both contact series conforms to the MIL-T-29504 fiber optic termini specification and fits into any size 16 cavity with no modification to the connector. The FOHC contact is designed for use with the standard size 16 insertion/extraction tool, and both the pin and socket end faces have easy access for cleaning. The FOHC precision ceramic tip offers superior coupling performance and a simplified termination process. Ceramic zirconia tips more accurately center the fiber within the contact body. During the mating engagement there is a rugged alignment sleeve which precisely aligns the mating contacts together for optimum performance. The jewel ferrule alignment system provides precise alignment regardless of fiber size, accommodates fiber tolerances, eliminates the requirement for a minimum end gap, and allows for spring loading of contacts.



2.3 PHD

ITT provides flexibility in the optical system design with the Cannon PHD line of high density optical interconnects. The PHD connector system's open architecture delivers high performance, density and serviceability in a flexible and scalable product configuration. The PHD optical interconnect provides solutions for the Telecommunication, Automotive, Commercial Aircraft, Data Communications, Industrial, Medical and Military Electronic industries.

The Cannon PHD interconnect is based around the industry standard 1.25 mm ceramic ferrule technology which allows rapid system integration and a common terminus platform for singlemode and multimode optical fiber solutions. The contact systems is offered in both a size 22 and size 16 contact assembly configuration which provides a cable termination range from 250 micron up to a 2 millimeter outer jacket along with different I.D. ferrule sizes to accommodate a large range of fiber types. Both the size 22 and size 16 contact assemblies utilize the same ceramic zirconia ferrule which meets the GR-326 endface geometry compliance. The PHD system assures the industry's highest and most stable performance for any multi-channel interconnect, resulting in the lowest insertion loss value, less channel to channel variance and a higher return loss of any fiber optic interconnect in the industry.



2.4 NGCON

The NGCON connector system is the new standard for military fiber optic interconnect applications. ITT's design will be qualified to the yet to be released NGCON Specification and will provide a high-performance fiber optic interconnect solution for air, sea and space applications. This new connector system was designed with innovations including genderless contacts and high density packaging combined with proven technology and features from connector standards 28876 and 38999.



		AIRBORNE	
		Exposed	Non-Exposed
	PHD 38999	P ¹	R
	PHD Panel Mount		R
	PHD Backplane		R
	PHD Super LC		R
	D-Sub Specials Hybrid Connector (Electrical & F.O.) w/custom F.O. inserts & PHD termini		R
	Trident Specials Hybrid Connector (Electrical & F.O.) w/custom F.O. inserts & PHD termini		R
	Rack & Panel Specials Hybrid Connector (Electrical & F.O.) w/custom F.O. inserts & PHD termini		R
	D38999 Hybrid Connector (Electrical & F.O.) w/ FOHC or 29504 Termini	P ²	R
	Rack & Panel Specials Hybrid Connector (Electrical & F.O.) w/custom F.O. inserts & 29504 termini		R
	M38999 Physical Contact	P ²	R
	M38999 Expanded Beam	P ²	R
	FOMC		
	NGCON	P ³	P ³
	ITAC		

R = Recommended Application
 P = Possible Application
 = Not recommended for this application

1 = Required for this application: Environmental sealed backshell, Mated condition or environmental sealed dust cap. Consult factory for recommended plating requirements
 2 = Required for this application: Environmental sealed backshell. Consult factory for recommended plating requirements
 3 = Product Release Scheduled for 2007 Q2

Build To Order Fiber Optic Harness Solutions

ITT has a world class Fiber Optic facility with proven reputation of delivering high quality, high performance fiber optic cable assemblies, for the Telecommunication, Automotive, Commercial Aircraft, Data Communications, Industrial, Medical and Military Electronic industries. ITT's fiber optic production facility is staffed with both project and manufacturing engineers along with highly skilled technicians/operators which work to strict military and commercial standards. Our in-house capabilities allow us to design, manufacture and test all in our production facility, and build standard to highly custom multi-channel cable assemblies complete in house. Our proven expertise allows us the ability to terminate all type of fiber in both singlemode and multimode along with terminating ferrule assemblies ranging from 1.25mm to 2.50mm and plastic fiber too, and meet the requirements of today's severe mechanical/environmental conditions. The key to developing a successful fiber optic system is understanding the performance and environmental requirements, implementing good design practices and utilizing appropriate components.

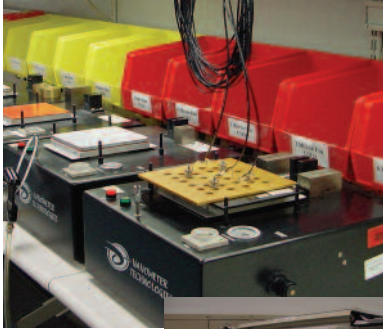
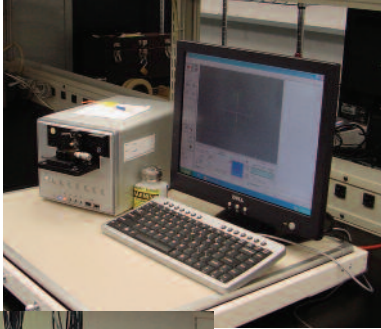

Cannon Space Connectors

1. MATERIAL CONTENT AND PHYSICAL FORM

Electrical connectors do not usually contain hazardous materials. They contain conducting and non-conducting materials and can be divided into two groups.

a) Printed circuit types and low cost audio types which employ all plastic insulators and casings.

b) Rugged, Fire Barrier and High Reliability types with metal casings and either natural rubber, synthetic rubber, plastic or glass insulating materials. Contact materials vary with type of connector and also application and are usually manufactured from either: Copper, copper alloys, nickel, alumel, chromel or steel. In special applications, other alloys may be specified.

2. FIRE CHARACTERISTICS AND ELECTRIC SHOCK HAZARD

There is no fire hazard when the connector is correctly wired and used within the specified parameters. Incorrect wiring or assembly of the connector or careless use of metal tools or conductive fluids, or transit damage to any of the component parts may cause electric shock or burns. Live circuits must not be broken by separating mated connectors as this may cause arcing, ionization and burning. Heat dissipation is greater at maximum resistance in a circuit. Hot spots may occur when resistance is raised locally by damage, e.g. cracked or deformed contacts, broken strands of wire. Local overheating may also result from the use of the incorrect application tools or from poor quality soldering or slack screw terminals. Overheating may occur if the ratings in the product Data Sheet/Catalog are exceeded and can cause breakdown of insulation and hence electric shock. If heating is allowed to continue it intensifies by further increasing the local resistance through loss of temper of spring contacts, formation of oxide film on contacts and wires and leakage currents through carbonization of insulation and tracking paths. Fire can then result in the presence of combustible materials and this may release noxious fumes. Overheating may not be visually apparent. Burns may result from touching overheated components.

3. HANDLING

Care must be taken to avoid damage to any component parts of electrical connectors during installation and use. Although there are normally no sharp edges, care must be taken when handling certain components to avoid injury to fingers. Electrical connectors may be damaged in transit to the customers, and damage may result in creation of hazards. Products should therefore be examined prior to installation/use and rejected if found to be damaged.

4. DISPOSAL

Incineration of certain materials may release noxious or even toxic fumes.

5. APPLICATION

Connectors with exposed contacts should not be selected for use on the current supply side of an electrical circuit, because an electric shock could result from touching exposed contacts on an unmated connector. Voltages in excess of 30 V ac or 42.5 V dc are potentially hazardous and care should be taken to ensure that such voltages cannot be transmitted in any way to exposed metal parts of the connector body. The connector and wiring should be checked, before making live, to have no damage to metal parts or insulators, no solder blobs, loose strands, conducting lubricants, swarf, or any other undesired conducting particles. Circuit resistance and continuity check should be made to make certain that there are no high resistance joints or spurious conducting paths. Always use the correct application tools as specified in the Data Sheet/Catalog. Do not permit untrained personnel to wire, assemble or tamper with connectors. For operation voltage please see appropriate national regulations.

IMPORTANT GENERAL INFORMATION

(i) Air and creepage paths/Operating voltage. The admissible operating voltages depend on the individual applications and the valid national and other applicable safety regulations.

For this reason the air and creepage path data are only reference values. Observe reduction of air and creepage paths due to PC board and/or harnessing.

(ii) Temperature

All information given are temperature limits. The operation temperature depends on the individual application.

(iii) Other important information

Cannon continuously endeavors to improve their products. Therefore, Cannon products may deviate from the description, technical data and shape as shown in this catalog and data sheets.

ITT Interconnect Solutions, a Division of ITT Corporation manufactures the highest quality products available in the marketplace; however these products are intended to be used in accordance with the specifications in this publication. Any use or application that deviates from the stated operating specifications is not recommended and may be unsafe. No information and data contained in this publication shall be construed to create any liability on the part of Cannon. Any new issue of this publication shall automatically invalidate and supersede any and all previous issues.

Product Warranty

A limited warranty applies to Cannon products. In general, except for obligations assumed by Cannon under this warranty, Cannon shall not be liable for any loss, damage, cost of repairs, incidental or consequential damages of any kind, whether or not based on express or implied warranty, contract, negligence or strict liability arising in connection with the design, manufacture, sale, use or repair of the products. Product availability, prices and delivery dates are exclusively subject to our respective order confirmation form; the same applies to orders based on development samples delivered. Please refer to www.ittcannon.com (General Terms of Sale) for the complete text of Cannon's applicable Terms and Conditions, including Warranty.

This publication is not to be construed as an offer. It is intended merely as an invitation to make an offer. By this publication, Cannon does not assume responsibility or any liability for any patent infringements or other rights of third parties which may result from its use.

Reprinting this publication is generally permitted, indicating the source. However, Cannon's prior consent must be obtained in all cases. "Engineered for life" is a registered trademark of ITT Corporation ©2006. All other trademarks or registered trademarks are property of their respective owners. All dates subject to change without notice.

Commodities in this catalog may be controlled for export by the International Traffic in Arms Regulations (ITAR) and Export Administration Regulations (EAR) when specifically designed modified, or configured for articles controlled by the United States Government.





Circular/Filter/Hermetic/Fiber Optic Connectors

As a world leader in circular, filter, and hermetic connectors, ITT can leverage its design and manufacturing expertise to fit virtually any application. Our expertise includes fast positive mating for a wide range of military applications, as well as numerous sizes and contact configurations for various harsh environments. Our wide variety of fiber optic products include hybrid contacts, multi-channel, rack and panel, and hi-rel assemblies, including MIL and ARINC standard solutions. ITT can meet numerous specs, including NATO and MIL standards.



www.ittcannon.com/circulars • www.ittcannon.com/filter • www.ittcannon.com/hermetics • www.ittcannon.com/fiberoptics

D-Subminiature Connectors

Cannon invented D-sub connectors in 1952. Our family of D-Subs now includes combinations of signal, power and RF, as well as severe service sealed connectors. Cannon D-Subs are available with an extensive line of backshells and accessories and are one of the most economical shielded connector solutions available. ITT D-Sub connectors are qualified to the MIL-DTL-24308 specification.

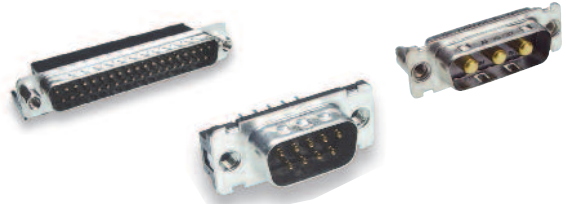

www.ittcannon.com/dsubs

Microminiature Connectors

Developed first by Cannon in the 1960's, Interconnect Solutions microminiature connectors offer high performance and reliability with exceptional versatility. Available in rectangular, circular, and strip configurations for countless applications, many of our connectors meet or exceed applicable requirements of the MIL-DTL-83513 specification.



www.ittcannon.com/micro

Rack and Panel Connectors

Initially pioneered by Cannon during the 1930s, Interconnect Solutions is the world leader in rack and panel connectors, offering unmatched variety of shell configurations and insert arrangements, materials, plating, and contact options. Many of our standard and custom designs meet the stringent requirements of ARINC 600, ARINC 404 (MIL-C-81659), and MIL-DTL-83733 standards.



www.ittcannon.com/rackandpanel

RF Connectors

ITT Interconnect Solutions has been providing interconnect products to the Microwave and RF industry since 1963 (formerly The Seaelectro Corporation). The RF 50 & 75 Ohm product lines cover UHF band through Ku band requirements. These connectors and cable assemblies are available with a thread type, snap type, bayonet type or slide on coupling method. The frequencies range from DC to 18+ GHz.



www.ittcannon.com/RF50 • www.ittcannon.com/RF75

Transportation

The ITT ICS interconnect range includes sealed circular and rectangular connectors in metal or plastic shells. These configurations include board to cable or cable to cable/ bulkhead applications. Both signal and power contacts can be combined in various layouts. All product lines within the Transportation segment offer very low contact resistance providing maximum signal integrity.



www.ittcannon.com/transportation

ITT Interconnect Solutions is an international manufacturer and supplier of connectors including circular, rectangular, fiber optic, RF, power and high voltage, audio, PMCIA, Compact Flash Card, enclosures, cable assemblies, and application specific custom solutions. The Interconnect Solutions portfolio includes the brands Cannon, VEAM, and BIW. As a worldwide leader in connector technology for nearly a century, ITT offers one of the broadest product offerings, six sigma manufacturing capability, Value Based Product Development with exceptional engineering capability, and an extensive sales, distribution, and customer support network.





ITT

Customer Support Locations

CHINA

Tuopandun Industrial Area, Jinda Cheng,
Xiner Village, Shajing Town,
Baoan District, Shenzhen City,
Guangdong, China 518125
Phone: +86.755.2726.7238
Fax: +86.755.2726.7515

GERMANY

Cannonstrasse 1
Weinstadt, 71384
phone: +49.7151.699.0
fax: +49.7151.699.217

FRANCE

15, Boulevard Robert Thiboust
Serris, France 77700
phone: +33.1.60.04.93.93
fax: +33.1.60.04.93.90

HONG KONG

Units 2405-6, 24/F, ING Tower
308 Des Voeux Road
Central
Hong Kong
phone: +852.2732.2720
fax: +852.2732.2919

ITALY

Corso Europa 41/43
Linate (MI),
Italy 20020
phone: +39.02938721
fax: +39.0293872300

JAPAN

11-3, 5 Chome, Hibarigaoka, Zama-shi
Kanagawa, Japan 228-0003
phone: +52.631.311.0050
fax: + 52.631.314.0060

UK

Jays Close, Viabes Estate
Basingstoke, RG22 4BA
phone: +44.1256.311200
fax: +44.1256.323356

USA

666 East Dyer Road
Santa Ana, CA 92705
toll free: 1.800.854.3028
phone: 1.714.557.4700
fax: 1.714.628.2142

©2009 ITT Corporation. "ITT," "Engineered for Life," the ITT Engineered Blocks Logo, "Cannon," "BIW Connector Systems," and "VEAM" are trademarks of ITT Corporation. Specification and other data are based on information available at the time of printing, and are subject to change without notice.

www.ittcannon.com

X-ON Electronics

Largest Supplier of Electrical and Electronic Components

Click to view similar products for [Hand Tools](#) category:

Click to view products by [ITT](#) manufacturer:

Other Similar products are found below :

[568681-1](#) [576786-2](#) [58061-1](#) [58176-1](#) [58177-1](#) [58177-2](#) [58284-1](#) [59085](#) [0031](#) [59737-5](#) [015-0339-000](#) [015-8755-001](#) [600-146-06](#) [M15570-25](#) [62200-5709](#) [6-304052-1](#) [63443-1002](#) [63443-3513](#) [63443-4025](#) [63443-7114](#) [6-354778-5](#) [6-354779-2](#) [63600-2995](#) [63810-0105](#) [M8196914-08](#) [M819698-07](#) [662508-1](#) [662908-1](#) [679994-1](#) [679994-2](#) [68764-0001](#) [69001-0105](#) [69002-5525](#) [690124-7](#) [690191-1](#) [690191-4](#) [690696-1](#) [691409-4](#) [691667-1](#) [692006-2](#) [692655-7](#) [692776-1](#) [692776-4](#) [693077-3](#) [693077-4](#) [693597-1](#) [D20418-137](#) [D20419-189](#) [ESR-17x17](#) [ET-LY10](#)