



ITT

Interconnect Solutions
Canon, VEAM, BIW

Defining **innovative**
aviation, military, and
industrial circulars since the DC-1,
over **70 years** ago



Engineered for life

FRF/FVF/FRA/FVA MIL-DTL-5015 Type Firewall Connectors



A

Circular

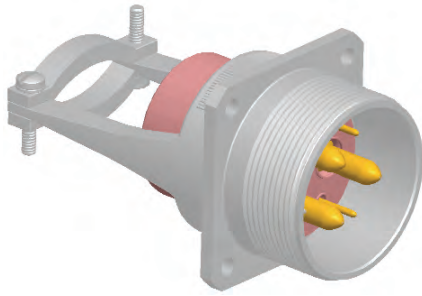

FRF/FVF Fire wall connectors are designed to meet the requirements of MIL-DTL-5015 and prevent the passage of +1093°C (+2000°F) flames for 20 minutes. They incorporate the latest sophisticated design improvements necessary to meet the exacting demands of supersonic flight applications. Some of these features are temperature capabilities to +204°C (+392°F) for more than 1000 hours, lighter weight, smaller than other MIL-DTL-5015 firewall connectors, and crimp front release contacts.

Firewall connectors fulfill the very important application of providing a means to penetrate the engine firewall of military and commercial aircraft

with electrical circuits, and still maintain the integrity of the flame barrier requirements of the aircraft firewall. These connectors provide protection against high temperatures, emergency fire-retardant conditions, moisture, atmospheric changes, and are resistant to fuels, cleaning agents, coolants, and hydraulic fluids. Materials of connector arrangements are designed to meet the requirements of MIL-DTL-5015 class K connectors.

The maximum operating temperature noted for these connectors is the maximum internal hot spot resulting from any combination of electrical load and ambient conditions.

How to Order

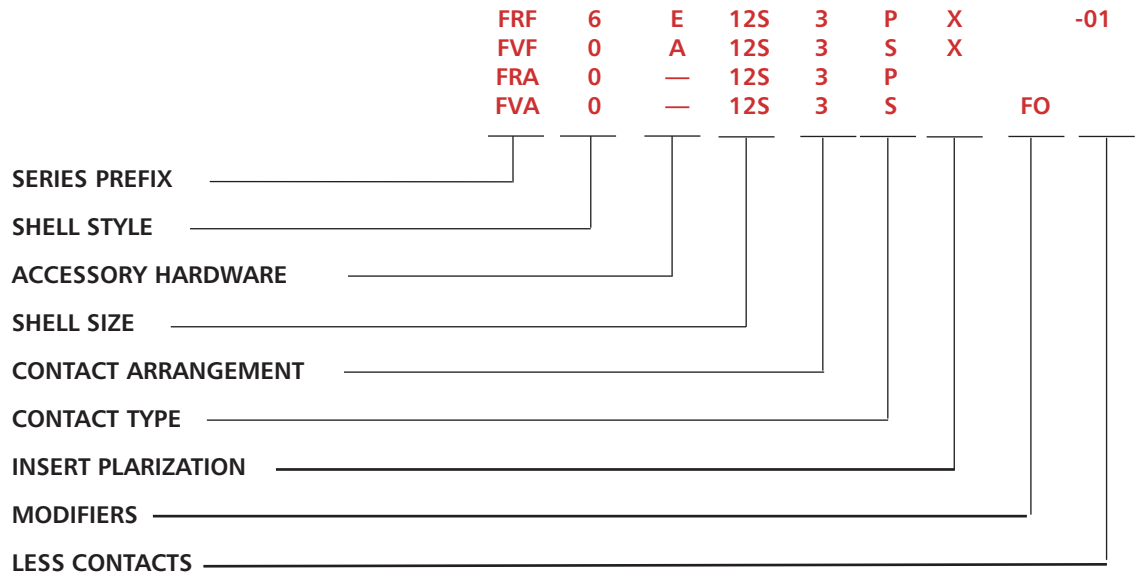

SERIES PREFIX

- FRF - Fluorosilicone elastomers, steel hardware with clear chromate (A105) finish
- FVF - Same as FRF except includes ferrule.
- FRA - Same as FRF except aluminum hardware
- FVA - Same as FVF except aluminum hardware

SHELL STYLE

- 6 - Plug
- 0 - Receptacle, flange mounting

ACCESSORY HARDWARE (ALUMINUM)

- E (FRF/FRA) - Endbell with cable clamp
- E (FVF/FVA) - Endbell with cable clamp with ferrules
- A (FRF/FRA) - Endbell adapter threaded for conduit
- A (FVF/FVA) - Endbell adapter threaded for conduit with ferrules
- Use dash (-) for connectors less accessories (Dash must be included in description)

SHELL SIZE

- 10SL, 12S, 14S, 16S, 16, 18, 20, 22, 24, 28, 32 and 36

CONTACT ARRANGEMENT

See page A-127

CONTACT TYPE

P for Pin; S for Socket

INSERT POLARIZATION

W, X, Y or Z in accordance with MIL-DTL-5015. No designator required for normal

LESS CONTACTS

FO - (Will not be stamped on connectors)

MODIFIERS

- 01 - Ball, self-locking knurled coupling nut (see note 1 below)
- 02 - Size 16 contacts to accommodate size 20 wire
- 03 - Clinch nut mounting receptacles (F28)
- 04 - Obsolete
- 05 - Knurled coupling nut
- 06 - Combination 01 and 02 codes
- 07 - Ferrules only (see note 4 below)
- 08 - Combination 01 and 07 codes (see note 4 below)
- 09 - Combination 05 and 07 codes (see note 4 below)
- 10 - Anchor nut plates on receptacle shells
- 11 - MS3057 type "A" endbell clamp, less bushing

MODIFIERS (continued)

- 12 - Combination 07 and 10 codes
- 13 - 01 code, with safety wire holes on coupling nut
- 14 - 90° endbell (with saddle clamp and ferrule)
- 15 - Combination 01 and 14 codes
- 16 - 03 code plus ferrules (code 07)
- 17 - Obsolete
- 18 - 01 code and steel conduit adapter
- 19 - FRFO/FVFO receptacle with steel conduit adapter
- A72 - Black chromate finish (by customer request)

NOTES

- Modifier 01: Used for high vibration/shock applications.
- Less Contacts: Use the Modifier "-FO" or "L". The Modifier will not be stamped on the connector. Modifier "-FO" is preferred.
- Numerical FRA/FRF modifiers are assigned consecutively as needed and there is no significance to numerical order.
- The basic FRA and FRF connectors were designed for use without ferrules. Ferrules are suggested when undersized wire is used so that the grommet seals will not spread apart (i. e. opened) when the wires are flexed as the wire maybe too stiff for its bend to be completely damped out by the endbell cable clamp.



Dimensions shown in inches (mm)
Specifications and dimensions subject to change

www.ittcannon.com

FRF/FVF/FRA/FVA
MIL-DTL-5015 Type Firewall Connectors

Design Features



A

Circular

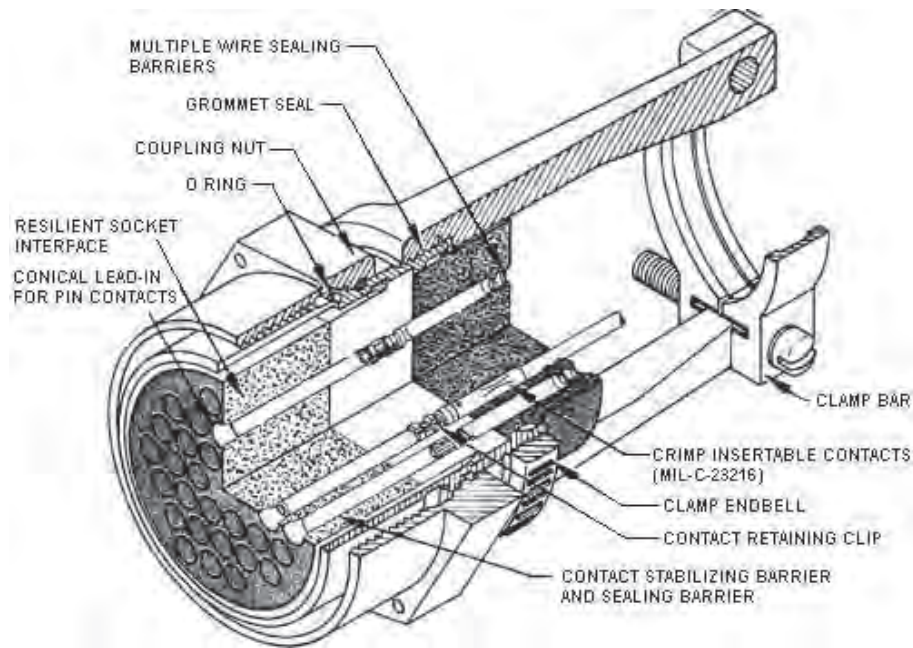

Complete Moisture Sealing

An improved shell-to-barrel O ring seals against pressure differential to 15 psi before and after exposure to +204°C (+392°F).

Positive interfacial sealing is accomplished with a pin and socket interlocking barrier design.

A highly reliable grommet sealing system incorporates multiple wire sealing barriers and a grommet-to-shell seal.

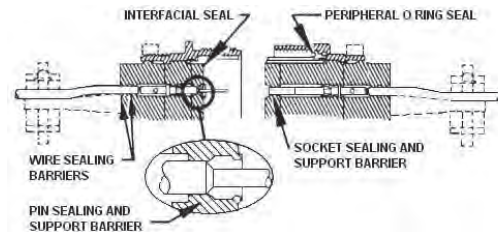

Rugged Metal Clip Retention System

These clips are one-piece metal parts with slotted, inwardly deflected tines assuring positive contact retention. They are retained and positively located in the hard insulator contact cavities by a molded-in-shoulder providing strength where the greatest load from mating and unmating occurs.

Contacts are seated on the clip shoulder, and the contact retaining clip locks on the tape retention undercut of the contact.

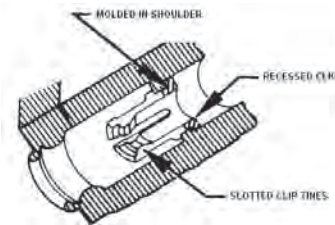

Improved Contact Alignment and Stability

The large lead-in chamfer on the semi-resilient insert provides positive contact alignment by "guiding" the tip of the pin contact into the mating socket. This chamfer provides maximum contact centering without restricting contact float or tool insertion.

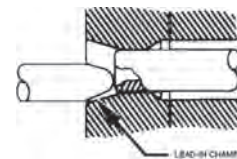

Optimal Self-Locking Coupling Nut

The mechanism employs a spring-loaded detent system that is free running until near full engagement. At this point torque valves increase causing the mechanism to produce an audible clicking until full engagement. The mechanism is effective even when coupling stops at a position between detents.

When full mating is achieved, a color appears in the indicator window on the periphery of the coupling nut. The indicator is serrated so that full mating can be determined in a blind installation by feel, with a probe approximately .0312 (0.79) diameter.

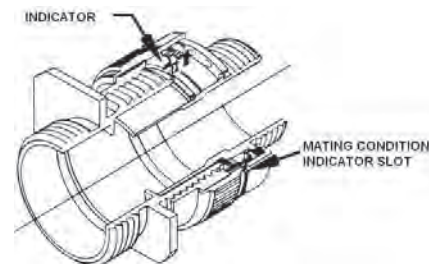

Dimensions shown in inches (mm)
Specifications and dimensions subject to change

www.ittcannon.com



FRF/FVF/FRA/FVA MIL-DTL-5015 Type Firewall Connectors



A

Circular

Performance and Material Specifications

ELECTRICAL DATA

Contact Size	Wire Size (MIL-W-5086)	Insulation OD min.	Limit max.
16	16 thru 20	.068(1.73)	.150 (3.81)
12	12 thru 14	.145 (3.68)	.200(5.08)
8	8 thru 10	.205 (5.21)	.300(7.62)
4	4 thru 6	.315 (8.00)	.425(10.80)
0	0 thru 2	.450 (11.43)	.590(14.99)

MATERIALS AND FINISHES

Shell - Machined cadmium plated steel (FRF/FVF)
- Aluminum (FRA/FVA)
Insulator - Glass-filled epoxy
Contacts - Copper alloy
Grommet and Interfical Seals-FRF-Flourosilicone/FVF
Silicone
Contacts - Copper alloy, gold plating per MIL-DTL-39029
Clip- Copper alloy

MECHANICAL FEATURES

Coupling - Threaded
Polarization - Single keyway per MIL-DTL-5015
Contact Retention - Metal Clip

Test Data (FRF and FVF Only)

Moisture Resistance - Exceed MIL-STD-202E Method 106D

Fire Test - Exceeds MIL-DTL-5015G, Para. 4.6.16

Fluid Emersion - Per MIL-DTL-5015G, Para. 4.6.15.3

Fluid	Use	Fluid	Use
JP-4	Aviation fuel	Navee 427	Alkaline cleaner
Kerosene	Aviation fuel	MIL-L-23699	Turbine lube oil
MIL-H-5606	Hydraulic fluid	Skydrol 500A	Hydraulic fluid
Ethylene Glycol	Synthetic coolant	MIL-L-7808D	Turbine lube oil
Cee-Bee A-693	Alkaline cleaner	Texaco 6256	Turbine lube oil

Contacts

Pin and Socket

Pin and socket contacts are machined from bar stock to assure precision operation. They are designed to resist severe vibration and repeated connection and disconnection. The average force to either engage or separate pin and socket contacts will not exceed the average values given in the latest revision MIL-DTL-39029.

Force in oz.	Contact Sizes				
	16	12	8	4	0
Maximum	30	30	160	240	320
Average	24	24	7	10.5	15
Minimum	2	3	5	10	14

Thermocouple Contacts

Size 12 and 16 contacts, machined from matching thermocouple lead wire alloys, can be supplied in ITT Cannon connectors. These thermocouple contacts maintain continuity from the thermal-sensor leads thru a bulkhead or other closures in temperature measuring applications.

These contacts for matching lead wires are detailed by the standards of the Instrument Society of America (I.S.A.).

I.S.A. Standards	Material
J	Iron and constantan
K	Chromel and alumel
T	Copper and constantan

Service Data

Maximum current ratings of contacts and maximum allowable voltage drop under test conditions when assembled as in service are shown. Maximum total current to be carried per connector is the same as that allowable in wire bundles as specified in MIL-W-5088.

CURRENT RATING WITH SILVER PLATED WIRE

Contact Size	Test Current (amps)	Potential Drop (millivolts)
16	13	49
12	23	42
8	46	26
4	80	23
0	150	21

High Potential Test Data

These connectors show no evidence of breakdown when the test voltage indicated is applied between the two closest contacts and between the shell and the contacts closest to the shell for a period of one minute.

MS Service Rating	TEST Voltage (RMS) 60 cps	Operating Voltages Suggested		Air Spacing nom. inches	Creepage Distance nom. inches
		DC	AC (rms)		
Inst.	1000	250	200	—	1/16
A	2000	700	500	1/16	1/8
D	2800	1250	900	1/8	3/16
E	3500	1750	1250	3/16	1/4
B	4500	2450	1750	1/4	5/16
C	7000	4200	3000	5/16	1



Dimensions shown in inches (mm)
Specifications and dimensions subject to change

www.ittcannon.com

FRF/FVF/FRA/FVA MIL-DTL-5015 Type Firewall Connectors

Wall Mounting Receptacle



A

Circular

FRF0/FVFO

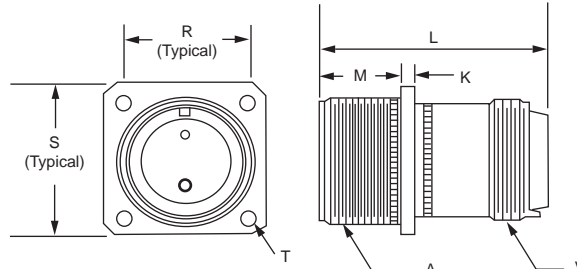

Shell Size	A Thread	L Max.			F Max.	K Max.	M +.031 -0.00	R ±.005	S Max.	T +.010 -0.005	T1 +.010 -0.005	V Thread	Z Min
		#16	#8	#4									
10SL	5/8-24UNEF-2A	1.685 (42.80)*	-	-	.455 (11.30)	.098 (2.49)	.562 (14.27)	.719 (18.26)	1.031 (26.19)	.150 (3.81)	.120 (3.04)	5/8-24UNEF-2A	.375 (9.52)
12S	3/4-20UNEF-2A	1.875 (47.62)	-	-	.455 (11.30)	.098 (2.49)	.562 (14.27)	.812 (20.62)	1.125 (28.58)	.150 (3.81)	.120 (3.04)	5/8-24UNEF-2A	.375 (9.52)
14S	7/8-20UNEF-2A	1.875 (47.62)	-	-	.522 (13.26)	.098 (2.49)	.562 (14.27)	.906 (23.01)	1.219 (30.96)	.150 (3.81)	.120 (3.04)	3/4-20UNEF-2A	.375 (9.52)
16S	1-20UNEF-2A	1.875 (47.62)	-	-	.647 (16.43)	.098 (2.49)	.562 (14.27)	.969 (24.61)	1.312 (30.96)	.150 (3.81)	.120 (3.04)	7/8-20UNEF-2A	.375 (9.52)
16	1-20UNEF-2A	1.922 (48.82)	2.141 (54.38)	-	.647 (16.43)	.098 (2.49)	.750 (19.05)	.969 (24.61)	1.312 (30.96)	.150 (3.81)	.120 (3.04)	7/8-20UNEF-2A	.625 (15.86)
20	1-1/4-18UNEF-2A	1.922 (48.82)	2.141 (54.38)	2.422 (61.52)	.921 (23.39)	.140 (3.56)	.750 (19.05)	1.156 (29.36)	1.531 (38.89)	.177 (4.50)	.120 (3.04)	1-1/8-18UNEF-2A	.625 (15.86)
22	1-3/8-18UNEF-2A	1.922 (48.82)	2.141 (54.38)	2.422 (61.52)	1.016 (25.81)	.140 (3.56)	.750 (19.05)	1.250 (31.75)	1.656 (42.06)	.177 (4.50)	.120 (3.04)	1-1/4-18UNEF-2A	.625 (15.86)
24	1-1/2-18UNEF-2A	1.922 (48.82)	2.141 (54.38)	2.422 (61.52)	1.141 (28.98)	.140 (3.56)	.812 (20.62)	1.375 (34.92)	1.781 (45.24)	.177 (4.50)	.147 (3.73)	1-3/8-18UNEF-2A	.625 (15.86)
28	1-3/4-18UNS-2A	1.922 (48.82)	2.141 (54.38)	2.422 (61.52)	1.361 (34.57)	.140 (3.56)	.812 (20.62)	1.562 (39.67)	2.031 (51.59)	.177 (4.50)	.147 (3.73)	1-5/8-18UNEF-2A	.625 (15.86)
32	2-18UNS-2A	1.922 (48.82)	2.141 (54.38)	2.422 (61.52)	1.611 (40.92)	.140 (3.56)	.875 (22.22)	1.750 (44.45)	2.281 (57.94)	.290 (5.31)	.173 (4.39)	1-7/8-16UN-2A	.625 (15.86)
36	2-1/4-16UN-2A	1.922 (48.82)	2.141 (54.38)	2.422 (61.52)	1.826 (46.38)	.140 (3.56)	.875 (22.22)	1.938 (49.23)	2.531 (64.29)	.290 (5.31)	.173 (4.39)	2-1/8-16UN-2A	.625 (15.86)

*Available with pin inserts only.

Straight Plug

FRF6/FVF6

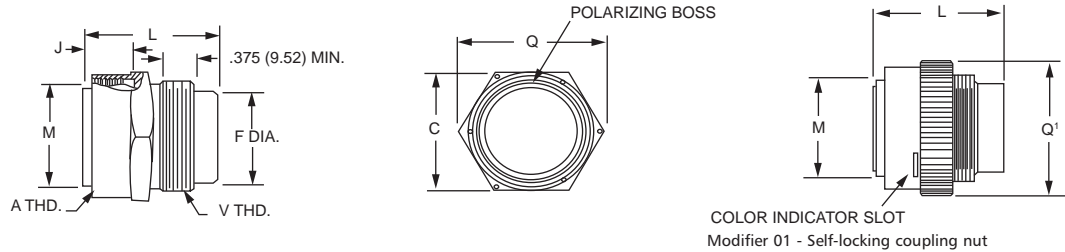

Shell Size	A Thread	L Max.			C Hex.	F Max.	J Max.	M Max.	Q Max.	Q1 Max	V Thread
		#16	#8	#4							
10SL	5/8-24UNEF-2B	1.819 (46.20)	-	-	.812 (20.62)	.455 (11.30)	.564 (14.33)	.446 (11.33)	.950 (24.13)	.970 (24.64)	5/8-24UNEF-2A
12S	3/4-20UNEF-2B	1.875 (47.62)	-	-	.937 (23.80)	.455 (11.30)	.564 (14.33)	.555 (14.10)	1.094 (27.79)	1.092 (27.74)	5/8-24UNEF-2A
14S	7/8-20UNEF-2B	1.875 (47.62)	-	-	1.000 (25.40)	.522 (13.26)	.564 (14.33)	.675 (17.14)	1.167 (29.64)	1.240 (31.50)	3/4-20UNEF-2A
16S	1-20UNEF-2B	1.875 (47.62)	-	-	1.125 (28.58)	.647 (16.43)	.564 (14.33)	.805 (20.45)	1.311 (33.30)	1.386 (35.20)	7/8-20UNEF-2A
16	1-20UNEF-2B	1.922 (48.82)	2.141 (54.38)	-	1.125 (28.58)	.647 (16.43)	.754 (19.15)	.805 (20.45)	1.311 (33.30)	1.386 (35.20)	7/8-20UNEF-2A
20	1-1/4-18UNEF-2B	1.922 (48.82)	2.141 (54.38)	2.422 (61.52)	1.375 (34.92)	.921 (23.39)	.754 (19.15)	1.050 (26.67)	1.600 (40.64)	1.650 (41.91)	1-1/8-18UNEF-2A
22	1-3/8-18UNEF-2B	1.922 (48.82)	2.141 (54.38)	2.422 (61.52)	1.500 (38.10)	1.016 (25.81)	.754 (19.15)	1.175 (29.84)	1.744 (44.30)	1.745 (44.32)	1-1/4-18UNEF-2A
24	1-1/2-18UNEF-2B	1.922 (48.82)	2.141 (54.38)	2.422 (61.52)	1.625 (41.28)	1.141 (28.98)	.754 (19.15)	1.300 (33.02)	1.833 (46.56)	1.962 (49.83)	1-3/8-18UNEF-2A
28	1-3/4-18UNS-2B	1.922 (48.82)	2.141 (54.38)	2.422 (61.52)	1.875 (47.62)	1.361 (34.57)	.754 (19.15)	1.520 (38.61)	2.177 (55.30)	2.125 (53.98)	1-5/8-18UNEF-2A
32	2-18UNS-2B	1.922 (48.82)	2.141 (54.38)	2.422 (61.52)	2.125 (43.96)	1.611 (40.92)	.754 (19.15)	1.770 (44.96)	2.466 (62.64)	2.385 (60.58)	1-7/8-16UN-2A
36	2-1/4-16UN-2B	1.922 (48.82)	2.141 (54.38)	2.422 (61.52)	2.375 (60.33)	1.826 (46.38)	.754 (19.15)	1.980 (50.29)	2.754 (69.95)	2.585 (65.66)	2-1/8-16UN-2A

*Available with socket inserts only.

Dimensions shown in inches (mm)
Specifications and dimensions subject to change

www.ittcannon.com



FRF/FVF/FRA/FVA MIL-DTL-5015 Type Firewall Connectors

Accessory Hardware



Circular

A

FRF0/FVFO

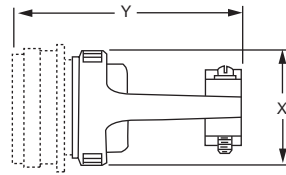
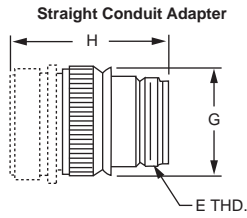

Straight Cable Clamp

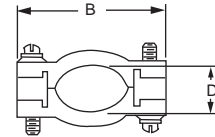

FRF6/FVF6

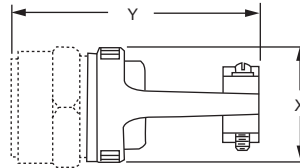
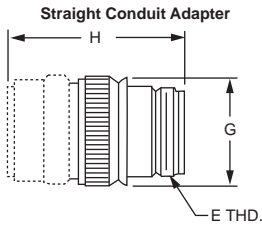

Straight Cable Clamp

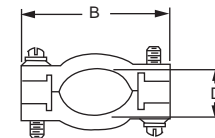

Shell Size	E Thread	B Max.	"D" Cable Diameter Max.	"D" Cable Diameter Min.	H G Max.	H Max.	X Max.	Y Max.
10SL	5/8-24UNEF-2A	1.00 (25.40)	.312 (7.92)	.188 (4.78)	.883 (22.43)	2.350 (59.69)	.953 (24.21)	2.940 (74.68)
12S	5/8-24UNEF-2A	1.00 (25.40)	.312 (7.92)	.188 (4.78)	.883 (22.43)	2.350 (59.69)	.953 (24.21)	2.940 (74.68)
14S	3/4-20UNEF-2A	1.190 (30.23)	.438 (11.12)	.282 (7.16)	1.003 (25.48)	2.350 (59.69)	1.078 (27.38)	3.090 (78.49)
16S	7/8-20UNEF-2A	1.280 (32.51)	.561 (14.25)	.344 (8.74)	1.133 (28.78)	2.350 (59.69)	1.203 (30.56)	3.410 (86.61)
16	7/8-20UNEF-2A	1.280 (32.51)	.561 (14.25)	.344 (8.74)	1.133 (28.78)	2.500 (63.50)	1.203 (30.56)	3.560 (90.42)
20	1-3/16-18UNEF-2A	1.530 (38.86)	.750 (19.05)	.438 (11.13)	1.430 (36.32)	3.000 (76.20)	1.453 (36.91)	3.560 (90.42)
22	1-3/16-18UNEF-2A	1.630 (41.40)	.750 (19.05)	.438 (11.13)	1.497 (38.02)	3.260 (82.80)	1.578 (40.08)	3.560 (90.42)
24	1-7/16-18UNEF-2A	1.775 (45.08)	.937 (23.80)	.562 (14.27)	1.573 (39.95)	3.260 (82.80)	1.703 (43.26)	3.900 (99.06)
28	1-7/16-18UNEF-2A	2.025 (51.44)	1.187 (30.15)	.750 (19.05)	1.792 (45.52)	3.260 (82.80)	1.953 (49.61)	3.900 (99.06)
32	1-3/4-18UNS-2A	2.265 (57.53)	1.250 (31.75)	.750 (19.05)	2.121 (53.87)	3.260 (82.80)	2.203 (55.96)	4.400 (111.76)
36	2-18UNS-2A	2.525 (64.14)	1.375 (34.92)	.782 (19.86)	2.308 (58.62)	3.300 (83.82)	2.453 (62.31)	4.650 (118.11)

Tooling

Contact Size	Crimp Tool	Crimp Head	Locator Number	Insertion Tool	Extraction Tool
16	M22520/1-01	M22520/1-02		MS90455-16 or MIL-I-81969/17-01	CET-FRF-16-22A
12				MS90455-12 or MIL-I-81960/17-02	CET-FRF-12
8	CBT-600B	CCH-8-1	CCHP-8-6	Not Req'd	CET-FRF-8
4	CBT-600B	CCH-4-1	CCHP-4-8	Not Req'd	CET-FRF-4
0	CBT-600B	CCH-0-1	CCHP-0-8	Not Req'd	CET-FRF-0

Contact/ Wire Seal Plugs

Contact Size	Pin	Part Number Socket	Wire Seal Plugs	Colors
16	980-2002-334	980-2002-339	225-0071-000	Blue
12	980-2002-335	980-2002-340	225-0072-000	Yellow
8	980-2002-336	980-2002-341	225-1009-000	Red
4	980-2002-337	980-2002-342	225-1008-000	Blue
0	980-2002-338	980-2002-343	225-1007-000	Yellow



Dimensions shown in inches (mm)
Specifications and dimensions subject to change

www.ittcannon.com

MIL-DTL-5015 Type Firewall Connectors

Availability Status

Layout	MS-K	CA-KE	FRF	Layout	MS-K	CA-KE	FRF
8S-1P	X	X		22-19P	X	X	
8S-1S	X	X		22-19S	X	X	
10SL-3P	X	X	X	22-22P	X	X	
10SL-3S	X	X	X	22-22S	X	X	X
10SL-4P	X	X		24-5P	X	X	
10SL-4S	X	X	X	24-5S	X	X	
12S-3P	X	X	X	24-7P	X	X	
12S-3S	X	X	X	24-7S	X	X	
12S-4P	X	X		24-9P	X		X
12S-4S	X	X		24-9S	X		X
14S-2P	X	X		24-10P		X	X
14S-2S	X	X	X	24-10S		X	X
14S-5P	X	X	X	24-11P			X
14S-5S	X	X	X	24-11S			X
14S-6P		X		24-22P	X		X
14S-6S		X	X	24-22S	X		X
14S-7P	X	X	X	24-28P	X	X	
14S-7S	X	X	X	24-28S	X	X	
14S-9P	X		X	28-2P	X	X	
14S-9S	X		X	28-2S	X	X	
16S-1P	X	X	X	28-11P	X	X	X
16S-1S	X	X	X	28-11S	X	X	X
16S-8P	X	X		28-12P	X	X	X
16S-8S	X	X	X	28-12S	X	X	X
16-11P	X			28-15P	X		
16-11S	X			28-15S	X		X
16-12P	X	X		28-20P	X	X	
16-12S	X	X		28-20S	X	X	
16-13P	X	X	X	28-21P	X	X	X
16-13S	X	X	X	28-21S	X	X	X
18-1P	X	X		28-22P			X
18-1S	X	X		28-22S			X
18-4P	X	X		32-1P	X		X
18-4S	X	X	X	32-1S	X		X
18-8P	X	X		32-5P		X	
18-8S	X	X		32-5S		X	
18-11P	X		X	32-6P	X	X	
18-11S	X		X	32-6S	X	X	X
20-4P	X	X	X	32-7P	X	X	X
20-4S	X	X	X	32-7S	X	X	X
20-7P	X	X		32-8P	X		X
20-7S	X	X		32-8S	X		X
20-15P	X	X		32-17P	X	X	X
20-15S	X	X		32-17S	X	X	X
20-18P	X	X		32A63P	X		
20-18S	X	X		32A63S	X		
20-22P		X		36-3P	X		
20-22S		X		36-3S	X		
20-27P	X	X	X	36-5P		X	X
20-27S	X	X	X	36-5S		X	X
22-2P	X		X	36-8P	X	X	
22-2S	X		X	36-8S	X	X	
22-14P	X	X	X	36-10P	X	X	
22-14S	X	X	X	36-10S	X	X	



A

Circular

For Configuration drawings, see pages A-85 to A-88.

X-ON Electronics

Largest Supplier of Electrical and Electronic Components

Click to view similar products for [D-Sub Standard Connectors](#) category:

Click to view products by [ITT](#) manufacturer:

Other Similar products are found below :

[56F711-015](#) [012-9507-004](#) [LV242999-142T12](#) [015-0341-000](#) [015-0349-000](#) [015-0372-005](#) [015-0372-008](#) [015-8755-001](#) [020419-0104](#) [012-0467-000](#) [012-0515-000](#) [012-9507-034](#) [012-9507-114](#) [020745-0008](#) [609-25P](#) [M24308/2-23Z](#) [CT2-14S-2PCA34](#) [CT2-18-11PCAU](#) [CT2-36-15SC](#) [CT6-14S-2SC](#) [CT6E14SA7SC](#) [CT6E22-14PC](#) [CT6E22-14PS](#) [CT6E22-22PS](#) [M83513/01-FC](#) [M85049/48-3-2F](#) [6STD09PCM99B70X](#) [6STD09SCM99B30X](#) [6STD09SCT99S40X](#) [6STD15PCT99S40X](#) [6STD15SCM99B30X](#) [6STD15SCT99S40X](#) [6STF09PCM05B70X](#) [7-135760-9](#) [MC11E-10-6SN](#) [747552-3](#) [MD1-21PS](#) [MDM-15SCBRM7-F222](#) [MDM96517-699](#) [MDM96521-744](#) [MDVB1-21SL1](#) [MIK0-1-7SH003](#) [MIKQ6-7SH076](#) [MIKQ7-7PH077](#) [MIKQ7-7PH11](#) [MIKQ7-7PH32](#) [MIKQ9-7PH003](#) [MJSV-28SL61](#) [MKJ4A1F14-55S](#) [8-135760-3](#)