



ITT

Interconnect Solutions  
Canon, VEAM, BIW

Defining **innovative**  
**aviation, military, and**  
**industrial circulars** since the DC-1,  
over **70 years** ago



*Engineered for life*

# Cannon KJA/KJB MIL-DTL-38999 Series III Connectors

## How To Order



**A**

Circular

Military Nomenclature

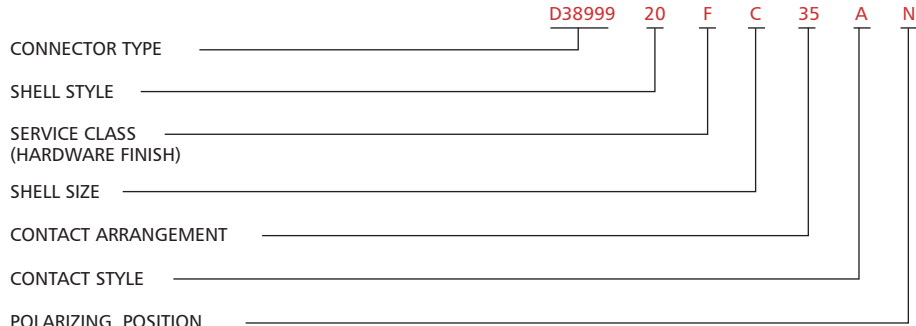

**CONNECTOR TYPE**  
D38999/ - MIL-DTL-38999 Series III

**CONTACT ARRANGEMENT**  
See pages A-24, A-25.

**SHELL STYLE**  
D38999/20 - Wall mount receptacle  
D38999/24 - Jam nut receptacle  
D38999/26 - Straight Plug, Grounded

**CONTACT STYLE**  
P - Pin contacts  
S - Socket contact  
A - Less Pin contacts\*  
B - Less Socket contact\*

**SERVICE CLASS**  
(Hardware Finish)  
F - Electroless nickel - 85°F to +392°F (-65°C to +200°C)  
G - Electroless nickel plated. Space Grade.  
W - Olive drab cadmium over electroless nickel plate, -85°F to +347°F (-65°C to +175°C)

\* Used only when other than power contacts are to be installed (i.e., shielded, thermocouple, etc.)

**POLARIZING POSITION**  
N (normal), A, B, C, D, E. See page A-23.

Note: To order MS connectors less standard power contacts, purchase order must state "Less Contacts".

**SHELL SIZE**

|   |    |    |    |    |    |    |    |    |  | Military Designation |
|---|----|----|----|----|----|----|----|----|--|----------------------|
| A | B  | C  | D  | E  | F  | G  | H  | J  |  |                      |
| 9 | 11 | 13 | 15 | 17 | 19 | 21 | 23 | 25 |  | Cannon Designation   |

Cannon Nomenclature

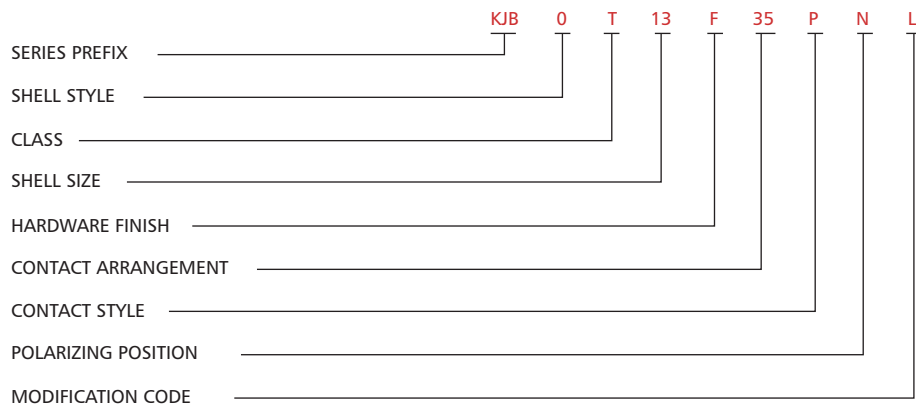

**SERIES PREFIX**  
KJA - Series III - Scoop proof, threaded coupling  
\*KJB - Series III - Scoop proof, threaded coupling, and with plastic contact retention

**SHELL STYLE**  
0 - Wall mount receptacle  
6 - Straight plug  
7 - Jam nut receptacle

**CLASS**  
T - Environment-resistant (without rear accessory)

\* Consult factory for applicable layouts

**SHELL SIZE**

|   |    |    |    |    |    |    |    |    |  | Cannon Designation   |
|---|----|----|----|----|----|----|----|----|--|----------------------|
| 9 | 11 | 13 | 15 | 17 | 19 | 21 | 23 | 25 |  |                      |
| A | B  | C  | D  | E  | F  | G  | H  | J  |  | Military Designation |

**HARDWARE FINISH**  
F - Electroless nickel, - 85°F to +392°F (-65°C to +200°C)  
G - Electroless nickel plated. Space Grade.  
W - Olive drab cadmium over electroless nickel plate, -85°F to +347°F (-65°C to +175°C)  
Z - Zinc Nickel, Black  
- - (Dash) When using a finish modification code

**CONTACT STYLE**  
P -Pin contacts  
S -Socket contacts

**POLARIZING POSITION**  
N (normal) A, B, C, D, E. See page A-23.

**MODIFICATION CODE**  
L - Less contacts, not stamped on connector  
16 - Outgassed  
NASA space graded connector  
27- Outgassed, standard connector  
T-69 Olive Drab (Green) Zinc Cobalt

**CONTACT ARRANGEMENTS**  
See pages A-24 and A-25.



Dimensions shown in inches (mm)  
Specifications and dimensions subject to change

www.ittcannon.com

# Cannon KJA/KJB MIL-DTL-38999 Series III Connectors

## Wall Mount Receptacle

D38999/20

KJA0T

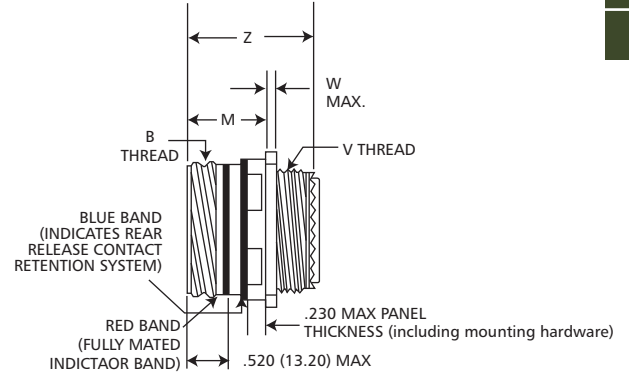
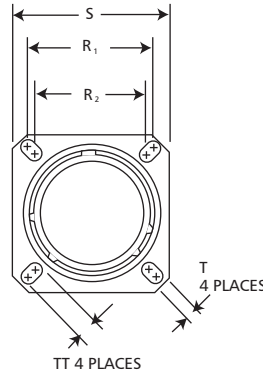

A

Circular

| Shell Size | MS Shell size Code | B Thread Class 2A (Plated) | M +.000 (.000) - .005 (.130) | R 1           | R 2           | S +.004 (.100) +.004 (.100) - .012 (.300) | T +.004 (.100) - .002 (.050) | TT +.004 (.100) - .002 (.050) | Metric V Thread (Plated) | W Max.      | Z +.005 (.130) - .010 (.250) |
|------------|--------------------|----------------------------|------------------------------|---------------|---------------|---|------------------------------|-------------------------------|--------------------------|-------------|------------------------------|
| 9          | A                  | .6250-0.1P-0.3L-TS         | .820 (20.83)                 | .719 (18.26)  | .594 (15.09)  | .938 (23.83)                              | .128 (3.25)                  | .216 (5.49)                   | M12X1-6g0.100R           | .098 (2.50) | 1.235 (31.36)                |
| 11         | B                  | .7500-0.1P-0.3L-TS         | .820 (20.83)                 | .812 (20.62)  | .719 (18.26)  | 1.031 (26.19)                             | .128 (3.25)                  | .194 (4.93)                   | M15X1-6g0.100R           | .098 (2.50) | 1.235 (31.36)                |
| 13         | C                  | .8750-0.1P-0.3L-TS         | .820 (20.83)                 | .906 (23.01)  | .812 (20.62)  | 1.125 (28.58)                             | .128 (3.25)                  | .194 (4.93)                   | M18X1-6g0.100R           | .098 (2.50) | 1.235 (31.36)                |
| 15         | D                  | 1.0000-0.1P-0.3L-TS        | .820 (20.83)                 | .969 (24.61)  | .906 (23.01)  | 1.219 (30.96)                             | .128 (3.25)                  | .173 (4.39)                   | M22X1-6g0.100R           | .098 (2.50) | 1.235 (31.36)                |
| 17         | E                  | 1.1875-0.1P-0.3L-TS        | .820 (20.83)                 | 1.062 (26.97) | .969 (24.61)  | 1.312 (33.32)                             | .128 (3.25)                  | .194 (4.93)                   | M25X1-6g0.100R           | .098 (2.50) | 1.235 (31.36)                |
| 19         | F                  | 1.2500-0.1P-0.3L-TS        | .820 (20.83)                 | 1.156 (29.36) | 1.062 (26.97) | 1.438 (36.53)                             | .128 (3.25)                  | .194 (4.93)                   | M28X1-6g0.100R           | .098 (2.50) | 1.235 (31.36)                |
| 21         | G                  | 1.3750-0.1P-0.3L-TS        | .790 (20.07)                 | 1.250 (31.75) | 1.156 (29.36) | 1.562 (39.67)                             | .128 (3.25)                  | .194 (4.93)                   | M31X1-6g0.100R           | .126 (3.20) | 1.235 (31.36)                |
| 23         | H                  | 1.5000-0.1P-0.3L-TS        | .790 (20.07)                 | 1.375 (34.92) | 1.250 (31.75) | 1.688 (42.88)                             | .154 (3.91)                  | .242 (6.15)                   | M34X1-6g0.100R           | .126 (3.20) | 1.235 (31.36)                |
| 25         | J                  | 1.6250-0.1P-0.3L-TS        | .790 (20.07)                 | 1.500 (38.10) | 1.375 (34.92) | 1.812 (46.02)                             | .154 (3.91)                  | .242 (6.15)                   | M37X1-6g0.100R           | .126 (3.20) | 1.235 (31.36)                |

## Straight Plug Grounded

D38999/26

KJA6T

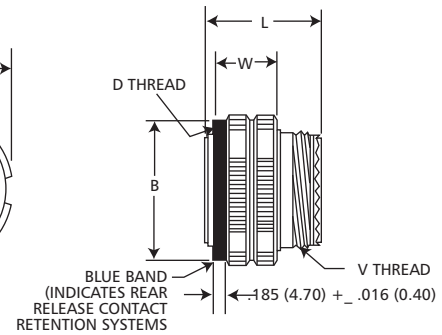
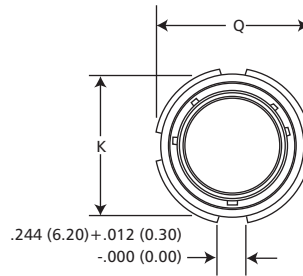

| Shell Size | MS Shell size Code | B +.008 (.200) - .000 (.000) | D Thread Class 2B (Plated) | K Max.        | L Max.        | Q Dia Max.    | Metric V Thread (Plated) | W +.008 (.200) - .004 (.100) |
|------------|--------------------|------------------------------|----------------------------|---------------|---------------|---------------|--------------------------|------------------------------|
| 9          | A                  | .724 (18.40)                 | .6250-0.1P-0.3L-TS         | .748 (19.00)  | 1.234 (31.34) | .859 (21.82)  | M12X1-6g0.100R           | .760 (19.30)                 |
| 11         | B                  | .831 (21.10)                 | .7500-0.1P-0.3L-TS         | .862 (21.90)  | 1.234 (31.34) | .969 (24.61)  | M15X1-6g0.100R           | .760 (19.30)                 |
| 13         | C                  | 1.000 (25.40)                | .8750-0.1P-0.3L-TS         | 1.027 (26.10) | 1.234 (31.34) | 1.141 (28.98) | M18X1-6g0.100R           | .760 (19.30)                 |
| 15         | D                  | 1.130 (28.70)                | 1.0000-0.1P-0.3L-TS        | 1.153 (29.30) | 1.234 (31.34) | 1.266 (32.16) | M22X1-6g0.100R           | .760 (19.30)                 |
| 17         | E                  | 1.268 (32.20)                | 1.1875-0.1P-0.3L-TS        | 1.291 (32.80) | 1.234 (31.34) | 1.391 (35.53) | M25X1-6g0.100R           | .760 (19.30)                 |
| 19         | F                  | 1.374 (34.90)                | 1.2500-0.1P-0.3L-TS        | 1.398 (35.50) | 1.234 (31.34) | 1.500 (38.10) | M28X1-6g0.100R           | .760 (19.30)                 |
| 21         | G                  | 1.500 (38.10)                | 1.3750-0.1P-0.3L-TS        | 1.524 (38.70) | 1.234 (31.34) | 1.625 (41.28) | M31X1-6g0.100R           | .760 (19.30)                 |
| 23         | H                  | 1.618 (41.40)                | 1.5000-0.1P-0.3L-TS        | 1.642 (41.70) | 1.234 (31.34) | 1.750 (44.45) | M34X1-6g0.100R           | .760 (19.30)                 |
| 25         | J                  | 1.744 (44.30)                | 1.6250-0.1P-0.3L-TS        | 1.768 (44.90) | 1.234 (31.34) | 1.875 (47.62) | M37X1-6g0.100R           | .760 (19.30)                 |

Performance Specifications-Pages A-7, A-8.

Contacts, Sealing Plugs, Assembly Tools - Pages A-26, A-32, A-33.

Contact Arrangements - Pages A-24, A-25.

Dimensions shown in inches (mm)  
Specifications and dimensions subject to change

www.ittcannon.com



# Cannon KJA/KJB MIL-DTL-38999 Series III Connectors

## Jam Nut Receptacle



D38999/24

KJA7T

A

Circular

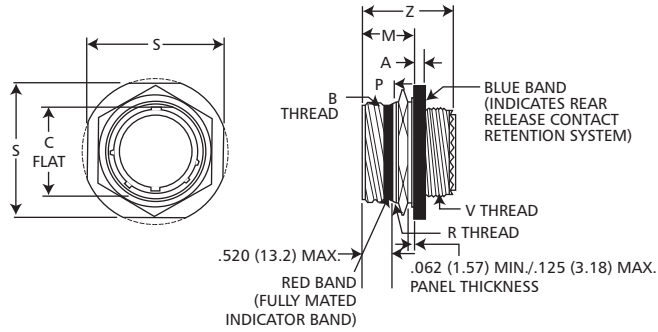

| Shell Size | MS Shell Code | A<br>+.010 (.250)<br>-.005 (.130) | B Thread<br>Class 2A<br>(Plated) | C<br>+.004 (.100)<br>-.010 (.250) | Z<br>+.005 (.130)<br>-.040 (.100) | M<br>+.005 (.130)<br>-.004 (.100) | P<br>+.016 (.410)<br>-.004 (.100) | S             | Metric R Thread<br>(Plated) | Metric V Thread<br>(Plated) |
|------------|---------------|-----------------------------------|----------------------------------|-----------------------------------|-----------------------------------|-----------------------------------|-----------------------------------|---------------|-----------------------------|-----------------------------|
| 9          | A             | .104 (2.64)                       | .6250-0.1P-0.3L-TS               | .651 (16.53)                      | 1.243 (31.57)                     | .871 (22.12)                      | .555 (14.10)                      | 1.062 (26.97) | M17X1-6g0.100R              | M12X1-6g0.100R              |
| 11         | B             | .104 (2.64)                       | .7500-0.1P-0.3L-TS               | .751 (19.07)                      | 1.243 (31.57)                     | .871 (22.12)                      | .555 (14.10)                      | 1.250 (31.75) | M20X1-6g0.100R              | M15X1-6g0.100R              |
| 13         | C             | .104 (2.64)                       | .8750-0.1P-0.3L-TS               | .938 (23.82)                      | 1.243 (31.57)                     | .878 (22.30)                      | .563 (14.30)                      | 1.375 (34.92) | M25X1-6g0.100R              | M18X1-6g0.100R              |
| 15         | D             | .104 (2.64)                       | 1.0000-0.1P-0.3L-TS              | 1.062 (26.97)                     | 1.243 (31.57)                     | .878 (22.30)                      | .563 (14.30)                      | 1.500 (38.10) | M28X1-6g0.100R              | M22X1-6g0.100R              |
| 17         | E             | .104 (2.64)                       | 1.1875-0.1P-0.3L-TS              | 1.187 (30.15)                     | 1.243 (31.57)                     | .878 (22.30)                      | .563 (14.30)                      | 1.625 (41.28) | M32X1-6g0.100R              | M25X1-6g0.100R              |
| 19         | F             | .135 (3.43)                       | 1.2500-0.1P-0.3L-TS              | 1.312 (33.32)                     | 1.243 (31.57)                     | .878 (22.30)                      | .563 (14.30)                      | 1.812 (46.02) | M35X1-6g0.100R              | M28X1-6g0.100R              |
| 21         | G             | .135 (3.43)                       | 1.3750-0.1P-0.3L-TS              | 1.437 (36.50)                     | 1.243 (31.57)                     | .878 (22.30)                      | .563 (14.30)                      | 1.938 (49.23) | M38X1-6g0.100R              | M31X1-6g0.100R              |
| 23         | H             | .135 (3.43)                       | 1.5000-0.1P-0.3L-TS              | 1.562 (39.67)                     | 1.243 (31.57)                     | .878 (22.30)                      | .563 (14.30)                      | 2.062 (52.37) | M41X1-6g0.100R              | M34X1-6g0.100R              |
| 25         | J             | .135 (3.43)                       | 1.6250-0.1P-0.3L-TS              | 1.687 (42.85)                     | 1.243 (31.57)                     | .878 (22.30)                      | .563 (14.30)                      | 2.188 (55.38) | M44X1-6g0.100R              | M37X1-6g0.100R              |

Performance Specifications-Pages A-7, A-8.

Contacts, Sealing Plugs, Assembly Tools - Pages A-26, A-32, A-33.

Contact Arrangements - Pages A-24, A-25.

## Panel Cutouts

### Wall Mounted Receptacle

### Jam Nut Receptacle

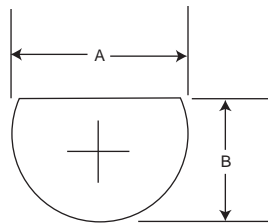
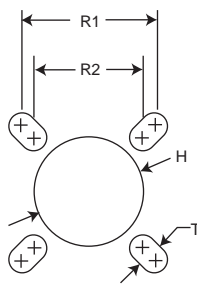

| Shell Size | A<br>+.010 (.25)<br>-.000 (.00) | B<br>+.000 (.00)<br>-.010 (.25) | H<br>+.010 (.25)<br>-.000 (.00) | R1<br>(TP)    | R2<br>(TP)    | T<br>(Max.) |
|------------|---------------------------------|---------------------------------|---------------------------------|---------------|---------------|-------------|
| 9          | .700 (17.78)                    | .670 (17.02)                    | .626 (15.90)                    | .719 (18.26)  | .594 (15.09)  | .134 (3.40) |
| 11         | .825 (20.96)                    | .771 (19.58)                    | .751 (19.08)                    | .812 (20.62)  | .719 (18.26)  | .134 (3.40) |
| 13         | 1.010 (25.65)                   | .955 (24.26)                    | .876 (22.25)                    | .906 (23.01)  | .812 (20.62)  | .134 (3.40) |
| 15         | 1.135 (28.83)                   | 1.085 (27.56)                   | 1.001 (25.43)                   | .969 (24.61)  | .906 (23.01)  | .134 (3.40) |
| 17         | 1.260 (32.00)                   | 1.210 (30.73)                   | 1.188 (30.18)                   | 1.062 (26.97) | .969 (24.61)  | .134 (3.40) |
| 19         | 1.385 (35.18)                   | 1.335 (33.91)                   | 1.251 (31.78)                   | 1.156 (29.36) | 1.062 (26.97) | .134 (3.40) |
| 21         | 1.510 (38.35)                   | 1.460 (37.08)                   | 1.376 (34.95)                   | 1.250 (31.75) | 1.156 (29.36) | .134 (3.40) |
| 23         | 1.635 (41.53)                   | 1.585 (40.26)                   | 1.511 (38.38)                   | 1.375 (34.92) | 1.250 (31.75) | .160 (4.06) |
| 25         | 1.760 (44.70)                   | 1.710 (43.43)                   | 1.626 (41.30)                   | 1.500 (38.10) | 1.375 (34.92) | .160 (4.06) |



Dimensions shown in inches (mm)  
 Specifications and dimensions subject to change

www.ittcannon.com

# Cannon KJL/KJ/KJA/KJB MIL-DTL-38999 Series I, II, III Connectors

## Polarizing Positions



A

Circular

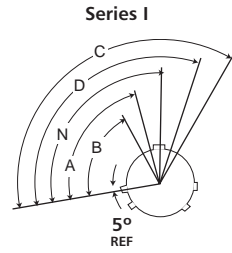

Front face of receptacle (plug opposite). Insert arrangement does not rotate with main key-keyway. The master key is rotated to provide shell polarization; the minor keys remain fixed.

| Shell Size | Angle of Rotation (Degrees) |     |     |      |      |
|------------|-----------------------------|-----|-----|------|------|
|            | Normal                      | A   | B   | C    | D    |
| 9          | 95°                         | 77° |     |      | 113° |
| 11         | 95°                         | 81° | 67° | 123° | 109° |
| 13         | 95°                         | 75° | 63° | 127° | 115° |
| 15         | 95°                         | 74° | 61° | 129° | 116° |
| 17         | 95°                         | 77° | 65° | 125° | 113° |
| 19         | 95°                         | 77° | 65° | 125° | 113° |
| 21         | 95°                         | 77° | 65° | 125° | 113° |
| 23         | 95°                         | 80° | 69° | 121° | 110° |
| 25         | 95°                         | 80° | 69° | 121° | 110° |

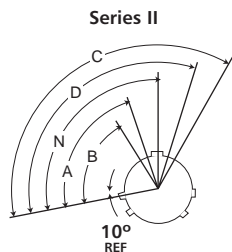

Front face of receptacle (plug opposite). Insert arrangement does not rotate with main key-keyway. The master key is rotated to provide shell polarization; the minor keys remain fixed.

| Shell Size | Angle of Rotation (Degrees) |     |     |      |      |
|------------|-----------------------------|-----|-----|------|------|
|            | Normal                      | A   | B   | C    | D    |
| 8          | 100°                        | 82° |     |      | 118° |
| 10         | 100°                        | 86° | 72° | 128° | 114° |
| 12         | 100°                        | 80° | 68° | 132° | 120° |
| 14         | 100°                        | 79° | 66° | 134° | 121° |
| 16         | 100°                        | 82° | 70° | 130° | 118° |
| 18         | 100°                        | 82° | 70° | 130° | 118° |
| 20         | 100°                        | 82° | 70° | 130° | 118° |
| 22         | 100°                        | 85° | 74° | 126° | 115° |
| 24         | 100°                        | 85° | 74° | 126° | 115° |

**Series III**  
RECEPTACLE  
(Front face shown)

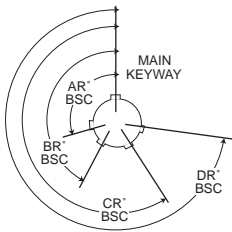

**PLUG**  
(Front face shown)

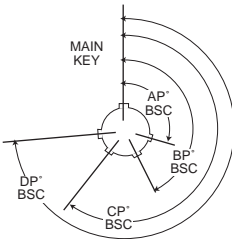

**NOTES**

- All Angles are BSC
- The insert arrangement does not rotate with main key/keyway
- All minor keys are rotated to provide shell polarization, the master key remains fixed at twelve o'clock position.
- Polarization is different from Series I and II.

| Shell Size | Key & Keyway Arrangement Identification Letter | Key Locations  |                |                |                |
|------------|--|----------------|----------------|----------------|----------------|
|            |  | AR° or AP° BSC | BR° or BP° BSC | CR° or CP° BSC | DR° or DP° BSC |
| 9          | N  | 105            | 140            | 215            | 265            |
|            | A  | 102            | 132            | 248            | 320            |
|            | B  | 80             | 118            | 230            | 312            |
|            | C  | 35             | 140            | 205            | 275            |
|            | D  | 64             | 155            | 234            | 304            |
| 11         | E  | 91             | 131            | 197            | 240            |
|            | N  | 95             | 141            | 208            | 236            |
|            | A  | 113            | 156            | 182            | 292            |
|            | B  | 90             | 145            | 195            | 252            |
|            | C  | 53             | 156            | 220            | 255            |
| 13         | D  | 119            | 146            | 176            | 298            |
|            | E  | 51             | 141            | 184            | 242            |
|            | N  | 80             | 142            | 196            | 293            |
|            | A  | 135            | 170            | 200            | 310            |
|            | B  | 49             | 169            | 200            | 244            |
| 15         | C  | 66             | 140            | 200            | 257            |
|            | D  | 62             | 145            | 180            | 280            |
|            | E  | 79             | 153            | 197            | 272            |
|            | N  | 80             | 142            | 196            | 293            |
|            | A  | 135            | 170            | 200            | 310            |
| 17         | B  | 49             | 169            | 200            | 244            |
|            | C  | 66             | 140            | 200            | 257            |
|            | D  | 62             | 145            | 180            | 280            |
|            | E  | 79             | 153            | 197            | 272            |
|            | N  | 80             | 142            | 196            | 293            |
| 19         | A  | 135            | 170            | 200            | 310            |
|            | B  | 49             | 169            | 200            | 244            |
|            | C  | 66             | 140            | 200            | 257            |
|            | D  | 62             | 145            | 180            | 280            |
|            | E  | 79             | 153            | 197            | 272            |
| 21         | N  | 80             | 142            | 196            | 293            |
|            | A  | 135            | 170            | 200            | 310            |
|            | B  | 49             | 169            | 200            | 244            |
|            | C  | 66             | 140            | 200            | 257            |
|            | D  | 62             | 145            | 180            | 280            |
| 23         | E  | 79             | 153            | 197            | 272            |
|            | N  | 80             | 142            | 196            | 293            |
|            | A  | 135            | 170            | 200            | 310            |
|            | B  | 49             | 169            | 200            | 244            |
|            | C  | 66             | 140            | 200            | 257            |
| 25         | D  | 62             | 145            | 180            | 280            |
|            | E  | 79             | 153            | 197            | 272            |



# Cannon KJL/KJ/KJA/KJB MIL-DTL-38999 Series I, II, III Connectors



## Contact Arrangements (Engaging View Pin Insert)

\* Socket insert only

\*\* Pin insert only (Not available in socket insert Series I and III)

Indicates layouts are available in all shell styles including MS27499, MS27508, KJ2E and KJ5E  
† Consult factory MS27505E/KJL5E insert availability

Circular

|                 |       |        |       |       |        |        |         |       |        |       |
|-----------------|-------|--------|-------|-------|--------|--------|---------|-------|--------|-------|
| Series III      | 9-98  | 9-35   | -     | 11-5  | 11-98  | -      | 11-35   | -     | -      | 13-8  |
| Series II       | 8-98† | 8-35†  | -     | 10-5† | 10-98† | 10-99† | 10-35†  | 12-3  | 12-4†  | 12-8† |
| Series I        | 9-98  | 9-35   | 11-4  | 11-5  | 11-98  | 11-99  | 11-35   | -     | 13-4** | 13-8  |
| No. of Contacts | 3 #20 | 6 #22D | 4 #20 | 5 #20 | 6 #20  | 7 #20  | 13 #22D | 3 #16 | 4 #16  | 8 #20 |
| Service Ratings | I     | M      | I     | I     | I      | I      | M       | II    | I      | I     |

|                 |        |         |       |               |        |        |         |
|-----------------|--------|---------|-------|---------------|--------|--------|---------|
| Series III      | 13-98  | 13-35   | 15-5  | 15-15         | 15-18  | 15-19  | 15-35   |
| Series II       | 12-98† | 12-35†  | 14-5† | 14-15†        | 14-18† | -      | 14-35†  |
| Series I        | 13-98  | 13-35   | 15-5  | 15-15         | 15-18  | 15-19  | 15-35   |
| No. of Contacts | 10 #20 | 22 #22D | 5 #16 | 14 #20, 1 #16 | 18 #20 | 19 #20 | 37 #22D |
| Service Ratings | I      | M       | II    | I             | I      | I      | M       |

|                 |              |       |       |        |         |        |               |
|-----------------|--------------|-------|-------|--------|---------|--------|---------------|
| Series III      | 15-97        | 17-6  | 17-8  | 17-26  | 17-35   | -      | -             |
| Series II       | 14-97†       | 16-6  | 16-8† | 16-26† | 16-35†  | 16-42† | 16-99†        |
| Series I        | 15-97        | 17-6  | 17-8  | 17-26  | 17-35   | 42 #22 | 17-99**       |
| No. of Contacts | 8 #20, 4 #16 | 6 #12 | 8 #16 | 26 #20 | 55 #22D | M      | 21 #20, 2 #16 |
| Service Ratings | I            | I     | II    | I      | M       | M      | I             |

|                 |               |               |        |        |         |
|-----------------|---------------|---------------|--------|--------|---------|
| Series III      | -             | -             | 19-11  | 19-32  | 19-35   |
| Series II       | 18-28         | 18-30         | 18-11  | 18-32† | 18-35†  |
| Series I        | 19-28**       | 19-30**       | 19-11  | 19-32  | 19-35   |
| No. of Contacts | 26 #20, 2 #16 | 29 #20, 1 #16 | 11 #16 | 32 #20 | 66 #22D |
| Service Ratings | I             | I             | II     | I      | M       |

|                 |        |        |         |               |        |
|-----------------|--------|--------|---------|---------------|--------|
| Series III      | 21-11  | 21-16  | 21-35   | 21-39         | 21-41  |
| Series II       | -      | 20-16† | 20-35†  | 20-39†        | 20-41† |
| Series I        | 21-11  | 21-16  | 21-35   | 21-39         | 21-41  |
| No. of Contacts | 11 #12 | 16 #16 | 79 #22D | 37 #20, 2 #16 | 41 #20 |
| Service Ratings | I      | II     | M       | I             | I      |

|                 |             |        |         |          |
|-----------------|-------------|--------|---------|----------|
| Series III      | 21-75       | 23-21  | -       | 23-35    |
| Series II       | -           | 22-21  | 22-32   | 22-35†   |
| Series I        | 21-75*      | 23-21  | 23-32** | 23-35    |
| No. of Contacts | 4 #8 Twinax | 21 #16 | 32 #20  | 100 #22D |
| Service Ratings | M           | II     | I       | M        |

Please consult factory for availability of layouts not shown.



Dimensions shown in inches (mm)  
Specifications and dimensions subject to change

www.ittcannon.com

# Cannon KJL/KJ/KJA/KJB MIL-DTL-38999 Series I, II, III Connectors

## Contact Arrangements (Engaging View Pin Insert)

\* Socket insert only  
\*\* Pin insert only (Not available in socket insert Series I and III)

† Indicates layouts are available in all shell styles including MS27499, MS27508, KJ2E and KJ5E  
• Consult factory for MS27505E/KJL5E insert availability



A

Circular

|   |        |        |               |
|---|--------|--------|---------------|
| Series III<br>Series II<br>Series I<br>No. of Contacts<br>Service Ratings |        |        |               |
|   | 23-53  | 23-55  | 25-4          |
|   | 22-53† | 22-55† | 24-4†         |
|   | 23-53  | 23-55  | 25-4          |
|   | 53 #20 | 55 #20 | 48 #20, 8 #16 |
|   | I      | I      | I             |

|   |             |        |   |                |        |
|---|-------------|--------|---|----------------|--------|
| Series III<br>Series II<br>Series I<br>No. of Contacts<br>Service Ratings |             |        |   |                |        |
|   | 25-8        | 25-19  | 25-20   | 25-24          | 25-29  |
|   | 25-8**      | 25-19  | 25-20*  | 24-24†         | 24-29† |
|   | 8 #8 Twinax | 19 #12 | 3 #8 Twinax, 13 #16,<br>4 #12 Coax, 10 #20<br>N / Coax / Twinax | 12 #16, 12 #12 | 25-29  |
|   | Twinax      | I      | I   | I              | I      |

|   |          |        |                              |                |                               |
|---|----------|--------|------------------------------|----------------|-------------------------------|
| Series III<br>Series II<br>Series I<br>No. of Contacts<br>Service Ratings |          |        |                              |                |                               |
|   | 25-35    | 25-37  | 25-42                        | 25-43          | 25-46                         |
|   | 24-35†   | 25-37* | 25-42*                       | 25-43          | 25-46                         |
|   | 128 #22D | 37 #16 | 36 #20, 4 #8 Coax<br>I, Coax | 23 #20, 20 #16 | 40 #20, 4 #16, 2 #8<br>Twinax |
|   | M        | II     | I                            | I              |                               |

|  |        |                                 |                        |
|--|--------|---------------------------------|------------------------|
| Series III<br>Series II<br>Series I<br>No. of Contacts<br>Service Rating |        |                                 |                        |
|  | 25-61  | 25-64                           | 25-66*                 |
|  | 24-61† | 25-64                           | 25-66*                 |
|  | 25-61  | 40 #22D, 8 #20<br>10 #16, 6 #12 | 53 #22D, 2 #20, 11 #16 |
|  | I      | I                               | I                      |

Dimensions shown in inches (mm)  
Specifications and dimensions subject to change

www.ittcannon.com



# Cannon KJL/KJ/KJA/KJB MIL-DTL-38999 Series I, II, III Connectors



A

Circular

## Contacts-Pin (Series I/II/III)

MIL-C-39029/58

KJL/KJ/KJA

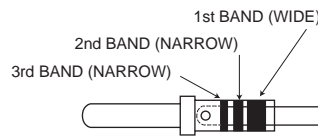

| Contact Size | 1      | Color Bands 2 | 3      | Cannon Part Number | M39029 Military Part Number |
|--------------|--------|---------------|--------|--------------------|-----------------------------|
| 22D          | Orange | Blue          | Black  | 980-0008-878       | M39029/58-360               |
| 20           | Orange | Blue          | Orange | 980-0008-879       | M39029/58-363               |
| 16           | Orange | Blue          | Yellow | 980-0008-880       | M39029/58-364               |
| 12           | Orange | Blue          | Green  | 980-0008-881       | M39029/58-365               |

| Contact Size | Cannon Part Number | Cable Accomodations |
|--------------|--------------------|---------------------|
| 8 Coax       | 95 Ohms            | 249-2196-000        |
|              |                    | 249-2196-001        |
|              |                    | 249-2196-002        |
| 8 Twinax     | 75 Ohms            | 980-1000-012        |
|              |                    | 12 Coax             |

## Contacts-Socket (Series II)

MIL-C-39029/57

KJ

Manufacture identification Code Area - Typical all contacts

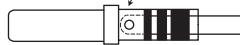

| Contact Size | 1      | Color Bands 2 | 3      | Cannon Part Number | M39029 Military Part Number |
|--------------|--------|---------------|--------|--------------------|-----------------------------|
| 22D          | Orange | Green         | Yellow | 980-0008-874       | M39029/57-354               |
| 20           | Orange | Green         | Violet | 980-0008-875       | M39029/57-357               |
| 16           | Orange | Green         | Gray   | 980-0008-876       | M39029/57-358               |
| 12           | Orange | Green         | White  | 980-0008-877       | M39029/57-359               |

## Contacts-Socket (Series I & III)

MIL-C-39029/56

KJL/KJA



| Contact Size | 1      | Color Bands 2 | 3      | Cannon Part Number | M39029 Military Part Number |
|--------------|--------|---------------|--------|--------------------|-----------------------------|
| 22D          | Orange | Yellow        | Gray   | 980-0008-870       | M39029/56-348               |
| 20           | Orange | Green         | Brown  | 980-0008-871       | M39029/56-351               |
| 16           | Orange | Green         | Red    | 980-0008-872       | M39029/56-352               |
| 12           | Orange | Green         | Orange | 980-0008-873       | M39029/56-353               |

| Contact Size | Cannon Part Number | Cable Accomodations |
|--------------|--------------------|---------------------|
| 8 Coax       | 95 Ohms            | 249-2195-000        |
|              |                    | 249-2195-001        |
|              |                    | 249-2195-002        |
| 8 Twinax     | 75 Ohms            | 980-1000-013        |
|              |                    | 12 Coax             |



Dimensions shown in inches (mm)  
Specifications and dimensions subject to change

www.ittcannon.com



# Cannon KJL/KJ/KJA/KJB MIL-DTL-38999 Series I, II, III Connectors

## Contact Sealing Bushings



A

Circular

**Size 8 Twinax Sealing Bushing** 321-1035-000  
Used with the Twinax contact in Twinax layouts for sealing cable size M17/176-00002

**Size 8 Coax Sealing Bushing** 321-1034-001  
Used with the Coax contact in Twinax layouts for sealing cable size RG-180



Twinax Grommet



Coax Grommet

## Contact Sealing Bushing Sequence into Twinax Grommet

(Bushing only used with Twinax grommet)

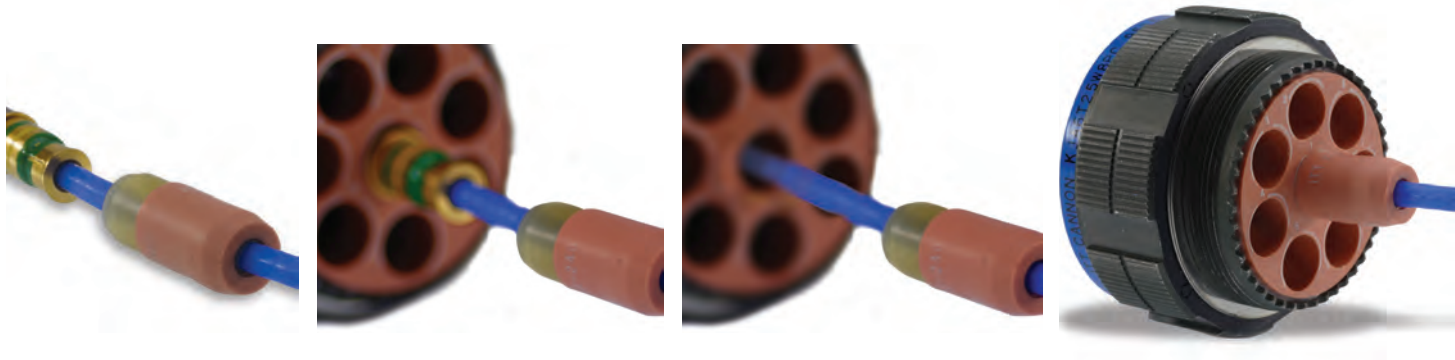

# Cannon KJL/KJ/KJA/KJB MIL-DTL-38999 Series I, II, III Connectors



Circular

## Contacts-Printed Circuit Board

### PIN PRINTED CIRCUIT CONTACT EXTENSION FROM REAR OF CONNECTOR (MAX / MIN)

| PC CONTACT PART NUMBER | CONTACT SIZE | TAIL DIA. ±.001 | MS27466                | MS27656                | MS27505E         | MS27472              | MS27499E                | MS27513E                             | MS27473               | D38999/20      | D38999/26      | D38999/24      | D38999/24      |
|------------------------|--------------|-----------------|------------------------|------------------------|------------------|----------------------|-------------------------|--------------------------------------|-----------------------|----------------|----------------|----------------|----------------|
|                        |              |                 | MS27467<br>KJL0 / KJL6 | MS27468<br>KJL3 / KJL7 | KJL5E            | MS27474<br>KJ0 / KJ7 | MS27508E<br>KJ2E / KJ5E | MS27497 / NO MS<br>KJ2R / KJ3 / KJ5R | MS27484<br>KJ6 / KJG6 |                |                |                |                |
| 030-2097-002           | 22D          | 0.020           | 0.261<br>0.189         | 0.244<br>0.176         | 0.408<br>0.376   | 0.264<br>0.226       | 0.408<br>0.376          | 0.264<br>0.226                       | 0.264<br>0.226        | 0.262<br>0.200 | 0.266<br>0.194 | 0.280<br>0.216 | 0.258<br>0.198 |
| 030-2097-006           | 22D          | 0.020           | 0.069<br>N/A           | 0.052<br>N/A           | 0.216<br>0.184   | 0.072<br>0.034       | 0.216<br>0.184          | 0.072<br>0.034                       | 0.072<br>0.034        | 0.070<br>0.008 | 0.074<br>0.002 | 0.088<br>0.024 | 0.066<br>0.006 |
| 030-2097-008           | 22D          | 0.020           | 0.216<br>0.144         | 0.199<br>0.131         | 0.363<br>0.331   | 0.219<br>0.181       | 0.363<br>0.331          | 0.219<br>0.181                       | 0.219<br>0.181        | 0.217<br>0.155 | 0.221<br>0.149 | 0.235<br>0.171 | 0.213<br>0.153 |
| 030-2097-015           | 22D          | 0.020           | 0.293<br>0.221         | 0.276<br>0.208         | 0.440<br>0.408   | 0.296<br>0.258       | 0.440<br>0.408          | 0.296<br>0.258                       | 0.296<br>0.258        | 0.294<br>0.232 | 0.298<br>0.226 | 0.312<br>0.248 | 0.290<br>0.230 |
| 030-1997-006           | 20           | 0.025           | 0.166<br>0.094         | 0.149<br>0.081         | 0.313<br>0.281   | 0.169<br>0.131       | 0.313<br>0.281          | 0.169<br>0.131                       | 0.169<br>0.131        | 0.167<br>0.105 | 0.171<br>0.099 | 0.185<br>0.121 | 0.163<br>0.103 |
| 030-1997-022           | 20           | 0.025           | 0.281<br>0.209         | 0.264<br>0.196         | 0.428*<br>0.396* | 0.284<br>0.246       | 0.428*<br>0.396*        | 0.284<br>0.246                       | 0.284<br>0.246        | 0.282<br>0.220 | 0.286<br>0.214 | 0.300<br>0.236 | 0.278<br>0.218 |
| 030-1997-030           | 20           | 0.019           | 0.364<br>0.292         | 0.347<br>0.279         | 0.511<br>0.479   | 0.367<br>0.329       | 0.511<br>0.479          | 0.367<br>0.329                       | 0.367<br>0.329        | 0.365<br>0.303 | 0.369<br>0.297 | 0.383<br>0.319 | 0.361<br>0.301 |
| 030-1995-023           | 16           | 0.062           | 0.278<br>0.206         | 0.261<br>0.193         | 0.425<br>0.393   | 0.281<br>0.243       | 0.425<br>0.393          | 0.281<br>0.243                       | 0.281<br>0.243        | 0.279<br>0.217 | 0.283<br>0.211 | 0.297<br>0.233 | 0.275<br>0.215 |
| 030-1995-024           | 16           | 0.062           | 0.118<br>0.046         | 0.101<br>0.033         | 0.265<br>0.233   | 0.121<br>0.083       | 0.265<br>0.233          | 0.121<br>0.083                       | 0.121<br>0.083        | 0.119<br>0.057 | 0.123<br>0.051 | 0.137<br>0.073 | 0.115<br>0.055 |

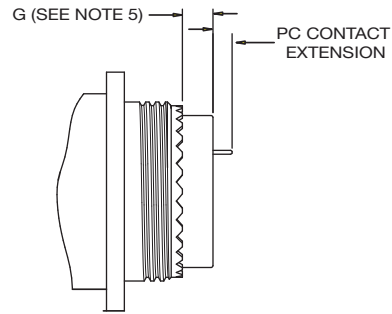
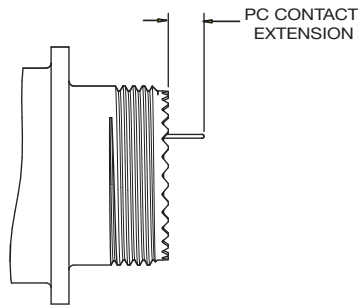

(KJL0/3/6/7 & KJA0/6/7)

(KJL5E, KJ0/2E/2R/3/5E/5R/6/7, & KJG6)

### SOCKET (SERIES II) PRINTED CIRCUIT CONTACT EXTENSION FROM REAR OF CONNECTOR (MAX / MIN)

| PC CONTACT PART NUMBER | CONTACT SIZE | TAIL DIA. ±.001 | MS27472              | MS27499E                | MS27513E                             | MS27473               |
|------------------------|--------------|-----------------|----------------------|-------------------------|--------------------------------------|-----------------------|
|                        |              |                 | MS27474<br>KJ0 / KJ7 | MS27508E<br>KJ2E / KJ5E | MS27497 / NO MS<br>KJ2R / KJ3 / KJ5R | MS27484<br>KJ6 / KJG6 |
| 031-1186-006           | 22D          | 0.020           | 0.179<br>0.141       | 0.323<br>0.291          | 0.179<br>0.141                       | 0.179<br>0.141        |
| 031-1186-011           | 22D          | 0.020           | 0.109<br>0.071       | 0.253<br>0.221          | 0.109<br>0.071                       | 0.109<br>0.071        |
| 031-1186-013           | 22D          | 0.020           | 0.217<br>0.179       | 0.361<br>0.329          | 0.217<br>0.179                       | 0.217<br>0.179        |
| 031-1186-021           | 22D          | 0.020           | 0.262<br>0.224       | 0.406<br>0.374          | 0.262<br>0.224                       | 0.262<br>0.224        |
| 031-1124-021           | 20           | 0.025           | 0.247<br>0.209       | 0.391*<br>0.359*        | 0.247<br>0.209                       | 0.247<br>0.209        |
| 031-1123-007           | 16           | 0.062           | 0.101<br>0.063       | 0.245<br>0.213          | 0.101<br>0.063                       | 0.101<br>0.063        |

### SOCKET (SERIE I & III) PRINTED CIRCUIT CONTACT EXTENSION FROM REAR OF CONNECTOR (MAX / MIN)

| PC CONTACT PART NUMBER | CONTACT SIZE | TAIL DIA. ±.001 | MS27466                | MS27656                | MS27505E         | D38999/20      | D38999/26      | D38999/24      | D38999/24      |
|------------------------|--------------|-----------------|------------------------|------------------------|------------------|----------------|----------------|----------------|----------------|
|                        |              |                 | MS27467<br>KJL0 / KJL6 | MS27468<br>KJL3 / KJL7 | KJL5E            | KJA0           | KJA6           | KJA7 (9-17)    | KJA7 (19-25)   |
| 031-1147-014           | 22D          | 0.021           | 0.244<br>0.172         | 0.227<br>0.159         | 0.391*<br>0.359* | 0.245<br>0.183 | 0.249<br>0.177 | 0.263<br>0.199 | 0.241<br>0.181 |
| 031-1147-039           | 22D          | 0.020           | 0.168<br>0.096         | 0.151<br>0.083         | 0.315*<br>0.283* | 0.169<br>0.107 | 0.173<br>0.101 | 0.187<br>0.123 | 0.165<br>0.105 |
| 031-1147-040           | 22D          | 0.020           | 0.438<br>0.366         | 0.421<br>0.353         | 0.585*<br>0.553* | 0.439<br>0.377 | 0.443<br>0.371 | 0.457<br>0.393 | 0.435<br>0.375 |
| 031-1124-040           | 20           | 0.025           | 0.486<br>0.414         | 0.469<br>0.401         | 0.633<br>0.601   | 0.487<br>0.425 | 0.491<br>0.419 | 0.505<br>0.441 | 0.483<br>0.423 |
| 031-1123-020           | 16           | 0.029           | 0.272<br>0.200         | 0.255<br>0.187         | 0.419<br>0.387   | 0.273<br>0.211 | 0.277<br>0.205 | 0.291<br>0.227 | 0.269<br>0.209 |

NOTES: UNLESS OTHERWISE SPECIFIED.

- PC CONTACTS HAVE GOLD PLATING OVER SUITABLE UNDERPLATE PER MIL-C-39029 SPECIFICATION.
- PC CONTACT EXTENSIONS APPLY TO ITT CANNON CONNECTORS ONLY FOR ALL SHELL SIZES.
- N/A INDICATES NO EXTENSION.
- \* INDICATES PC TAIL WITH STEP EXTENDING FROM REAR OF CONNECTOR.
- G DIM. IS .031 +/- .016 FOR KJL5E AND .120 +/- .030 (SHELL SIZES 8 THRU 22) AND .090 +/- .050 (SHELL SIZE 24) FOR KJ0/2E/2R/3/5E/5R/6/7 & KJG6.
- FOR OTHER SPECIFIC PC CONTACT DATA, CONSULT ITT EC, SANTA ANA, CA, USA.



Dimensions shown in inches (mm)  
Specifications and dimensions subject to change

www.ittcannon.com

Cannon KJL/KJ/KJA/KJB  
MIL-DTL-38999 Series I, II, III Connectors

**Wire Sizes and Diameters**

| Contact Size | Wire size (AWG) | Finished wire outside dimensions |         |
|--------------|-----------------|----------------------------------|---------|
|              |                 | Minimum                          | Maximum |
| 22D          | 28, 26, 24, 22  | 0.030                            | 0.054   |
| 22M*         | 28, 26, 24      | 0.030                            | 0.050   |
| 22*          | 26, 24, 22      | 0.034                            | 0.060   |
| 20           | 24, 22, 20      | 0.040                            | 0.083   |
| 16           | 20, 18, 16      | 0.065                            | 0.109   |
| 12           | 14, 12          | 0.097                            | 0.142   |
| 8 Coax       | RG-180          | 0.136                            | 0.146   |
| 8 Twinax     | M17/176-00002   | 0.124                            | 0.134   |
| 12 Coax      | RG174, 179, 316 | 0.094                            | 0.102   |

\*For reference only



A

Circular

**Recommended Jam Nut Torque Values**

| Series II  |             | Series I & III |             |
|------------|-------------|----------------|-------------|
| Shell Size | Inch-Pounds | Shell Size     | Inch-Pounds |
| 8          | 46/50       | 9              | 30/36       |
| 10         | 55/60       | 11             | 40/46       |
| 12         | 70/75       | 13             | 55/60       |
| 14         | 80/85       | 15             | 70/75       |
| 16         | 90/95       | 17             | 80/85       |
| 18         | 100/110     | 19             | 90/95       |
| 20         | 110/120     | 21             | 100/110     |
| 22         | 120/130     | 23             | 110/120     |
| 24         | 140/150     | 25             | 120/130     |

**Coupling Nut Torque Values (Series I, II and III)**

| Maximum engagement and disengagement |            | Minimum disengagement |
|--------------------------------------|------------|-----------------------|
| Shell Size                           | Inch Pound | Inch Pound            |
| 8                                    | 8          | 2                     |
| 9                                    | 8          | 2                     |
| 10                                   | 12         | 2                     |
| 11                                   | 12         | 2                     |
| 12                                   | 16         | 2                     |
| 13                                   | 16         | 2                     |
| 14                                   | 20         | 4                     |
| 15                                   | 20         | 3                     |
| 16                                   | 24         | 4                     |
| 17                                   | 24         | 3                     |
| 18                                   | 28         | 5                     |
| 19                                   | 28         | 3                     |
| 20                                   | 32         | 6                     |
| 21                                   | 32         | 5                     |
| 22                                   | 36         | 7                     |
| 23                                   | 36         | 5                     |
| 24                                   | 36         | 7                     |
| 25                                   | 40         | 5                     |

Dimensions shown in inches (mm)  
Specifications and dimensions subject to change

www.ittcannon.com



# Cannon KJL/KJ/KJA/KJB MIL-DTL-38999 Series I, II, III Connectors



A

Circular

## Backshell - Type E (Straight), Series II only

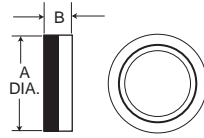

| Shell Size |               |             |
|------------|---------------|-------------|
| Series II  | A Dia. Max.   | B Dia. Max. |
| 8          | .580 (14.73)  | .328 (8.33) |
| 10         | .705 (17.91)  | .328 (8.33) |
| 12         | .830 (21.08)  | .328 (8.33) |
| 14         | .955 (24.26)  | .328 (8.33) |
| 16         | 1.080 (27.32) | .328 (8.33) |
| 18         | 1.205 (30.61) | .328 (8.33) |
| 20         | .330 (33.78)  | .328 (8.33) |
| 22         | 1.455 (36.96) | .328 (8.33) |
| 24         | 1.555 (39.50) | .270 (6.86) |

### How To Order

| Shell Size | Finishes                         |                                |                              |                                |
|------------|----------------------------------|--------------------------------|------------------------------|--------------------------------|
|            | A                                | B                              | C                            | N                              |
| Series II  | Cadmium/Nickel-Clear Part Number | Cadmium/Nickel-O.D Part Number | Anodic Non-Cond. Part Number | Electroless Nickel Part Number |
| 8          | 057-0776-000                     | 057-0862-000                   | 057-0819-000                 | 057-0776-002                   |
| 10         | 057-0777-000                     | 057-0863-000                   | 057-0820-000                 | 057-0777-002                   |
| 12         | 057-0778-000                     | 057-0864-000                   | 057-0821-000                 | 057-0778-002                   |
| 14         | 057-0779-000                     | 057-0846-000                   | 057-0822-000                 | 057-0779-002                   |
| 16         | 057-0780-000                     | 057-0847-000                   | 057-0823-000                 | 057-0780-002                   |
| 18         | 057-0781-000                     | 057-0848-000                   | 057-0824-000                 | 057-0781-002                   |
| 20         | 057-0782-000                     | 057-0849-000                   | 057-0825-000                 | 057-0782-002                   |
| 22         | 057-0783-000                     | 057-0850-000                   | 057-0826-000                 | 057-0783-002                   |
| 24         | 057-0784-000                     | 057-0851-000                   | 057-0827-000                 | 057-0784-002                   |

## Backshell - Type F (Cable Clamp)

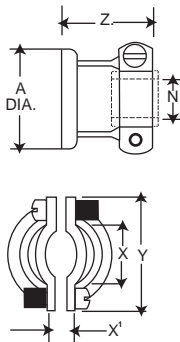

| Shell Size |           |               |              |              |              |               |              |
|------------|-----------|---------------|--------------|--------------|--------------|---------------|--------------|
| Series I   | Series II | A Max.        | N Dia. Max.  | X Dia. Min.  | X' Dia. Min. | Y Max.        | Z Max.       |
| 9          | 8         | .508 (14.73)  | .135 (3.43)  | .234 (5.94)  | .187 (4.75)  | .829 (21.06)  | .813 (20.65) |
| 11         | 10        | .705 (17.91)  | .198 (5.03)  | .297 (7.54)  | .187 (4.75)  | .891 (22.63)  | .813 (20.65) |
| 13         | 12        | .830 (21.08)  | .322 (7.18)  | .422 (10.72) | .281 (7.14)  | 1.016 (25.81) | .813 (20.65) |
| 15         | 14        | .955 (24.26)  | .385 (9.78)  | .547 (12.89) | .325 (8.26)  | 1.141 (28.98) | .813 (20.65) |
| 17         | 16        | 1.080 (27.43) | .510 (12.95) | .609 (15.47) | .356 (9.04)  | 1.203 (30.56) | .933 (23.70) |
| 19         | 18        | 1.205 (30.61) | .635 (16.13) | .734 (18.64) | .456 (11.58) | 1.469 (37.31) | .933 (23.70) |
| 21         | 20        | 1.330 (33.78) | .635 (16.13) | .734 (18.64) | .519 (13.18) | 1.469 (37.31) | .933 (23.70) |
| 23         | 22        | 1.455 (36.96) | .760 (19.30) | .922 (23.42) | .519 (13.18) | 1.656 (42.06) | .933 (23.70) |
| 25         | 24        | 1.555 (39.50) | .810 (20.57) | .984 (24.99) | .657 (16.69) | 1.750 (44.45) | .893 (22.68) |

### How To Order (MS Version)

**MS27506 - A - 8 - 2**

**Military Designation**  
MS27506 Type F Straight with Cable Clamp

**Finish**  
A - Cad/Nickel (Clear)  
B - Cad/Nickel (O.D)  
F - Nickel (Electroless)

**Shell Size**  
Series I - 9, 11, 13, 15, 17, 19, 21, 23, 25  
Series II - 8, 10, 12, 14, 16, 18, 20, 22, 24

**Adapter**  
Geometry - 2

| Shell Size |           | Finishes       |                    |          |      |          |      |          |      |
|------------|-----------|----------------|--------------------|----------|------|----------|------|----------|------|
| Series I   | Series II | MS Part Number | Cannon Part Number | A Cannon | A MS | B Cannon | B MS | N Cannon | F MS |
| 9          | 8         | 27506*-8-2     | 057-3005-***       | -012     | A    | -013     | B    | -015     | F    |
| 11         | 10        | 27506*-10-2    | 057-3006-***       | -011     | A    | -012     | B    | -014     | F    |
| 13         | 12        | 27506*-12-2    | 057-3007-***       | -012     | A    | -013     | B    | -015     | F    |
| 15         | 14        | 27506*-14-2    | 057-3008-***       | -010     | A    | -011     | B    | -013     | F    |
| 17         | 16        | 27506*-16-2    | 057-3009-***       | -012     | A    | -013     | B    | -015     | F    |
| 19         | 18        | 27506*-18-2    | 057-3010-***       | -013     | A    | -014     | B    | -016     | F    |
| 21         | 20        | 27506*-20-2    | 057-3011-***       | -011     | A    | -013     | B    | -015     | F    |
| 23         | 22        | 27506*-22-2    | 057-3012-***       | -015     | A    | -016     | B    | -018     | F    |
| 25         | 24        | 27506*-24-2    | 057-3013-***       | -013     | A    | -014     | B    | -017     | F    |

\* MS Finish      \*\*\* Cannon Finish



Dimensions shown in inches (mm)  
Specifications and dimensions subject to change

www.ittcannon.com

**Cannon KJL/KJ/KJA/KJB  
MIL-DTL-38999 Series I, II, III Connectors**

| Shell Size Series III | Military Part Number | Cannon Part Number | Cannon | Military | Cannon | Military |
|-----------------------|----------------------|--------------------|--------|----------|--------|----------|
| 9                     | M85049/ 38-9 **      | 970-6000-***       | -336   | N        | -345   | W        |
| 11                    | M85049/ 38-11 **     | 970-6000-***       | -337   | N        | -346   | W        |
| 13                    | M85049/ 38-13 **     | 970-6000-***       | -338   | N        | -347   | W        |
| 15                    | M85049/ 38-15 **     | 970-6000-***       | -339   | N        | -348   | W        |
| 17                    | M85049/ 38-17 **     | 970-6000-***       | -340   | N        | -349   | W        |
| 19                    | M85049/ 38-19 **     | 970-6000-***       | -341   | N        | -350   | W        |
| 21                    | M85049/ 38-21 **     | 970-6000-***       | -342   | N        | -351   | W        |
| 23                    | M85049/ 38-23 **     | 970-6000-***       | -343   | N        | -352   | W        |
| 25                    | M85049/ 38-25 **     | 970-6000-***       | -344   | N        | -353   | W        |



Circular

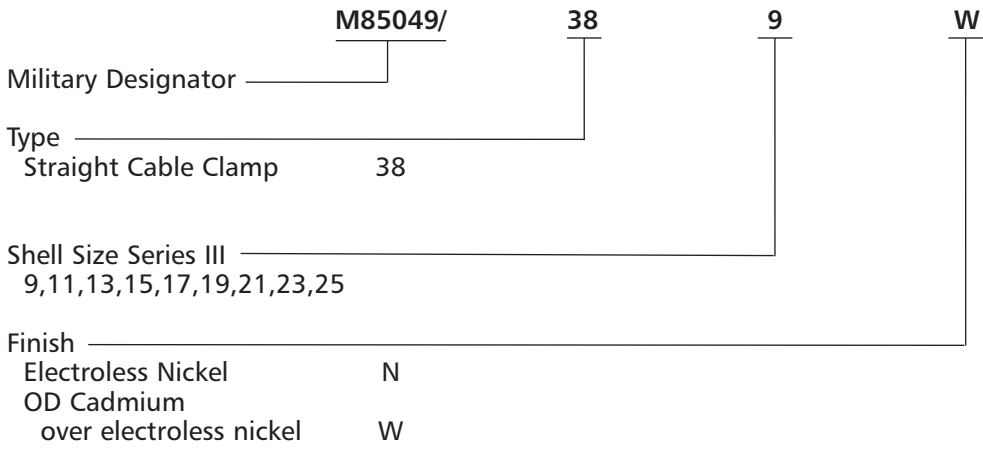

\*\* Finish  
\*\*\* Cannon Part No.



# Cannon KJL/KJ/KJA/KJB MIL-DTL-38999 Series I, II, III Connectors



A

Circular

## Backshell - Type P (Potting Boot)

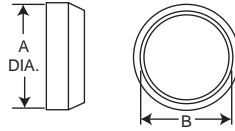

| Shell Size |           | A Dia. Max.   | B Dia. Max.   |
|------------|-----------|---------------|---------------|
| Series I   | Series II |               |               |
| 9          | 8         | .598 (15.19)  | .434 (11.02)  |
| 11         | 10        | .723 (18.36)  | .548 (13.92)  |
| 13         | 12        | .847 (21.51)  | .673 (17.09)  |
| 15         | 14        | .969 (24.61)  | .798 (20.27)  |
| 17         | 16        | 1.087 (27.61) | .899 (22.83)  |
| 19         | 18        | 1.211 (30.76) | 1.024 (26.01) |
| 21         | 20        | 1.336 (33.93) | 1.141 (29.98) |
| 23         | 22        | 1.461 (37.11) | 1.274 (32.36) |
| 25         | 24        | 1.586 (40.28) | 1.399 (35.53) |

How To Order (MS Version)

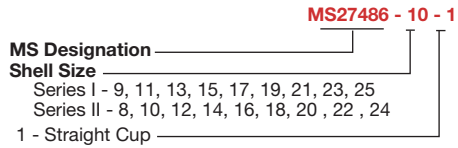

NOTE: When ordering the MS version you must specify both MS numbers for the Potting Boot and the Adapter Ring.

| Shell Size |           | MS27486 Part Number | Cannon Part Number |
|------------|-----------|---------------------|--------------------|
| Series I   | Series II |                     |                    |
| 9          | 8         | 27486--1            | 040-0185-000       |
| 11         | 10        | 27486--1            | 040-0169-000       |
| 13         | 12        | 27486--1            | 040-0170-000       |
| 15         | 14        | 27486--1            | 040-0171-000       |
| 17         | 16        | 27486--1            | 040-0172-000       |
| 19         | 18        | 27486--1            | 040-0173-000       |
| 21         | 20        | 27486--1            | 040-0174-000       |
| 23         | 22        | 27486--1            | 040-0175-000       |
| 25         | 24        | 27486--1            | 040-0176-000       |

\*\* Only even numbered shell size is applicable.

## Potting Boot Adapter Ring

How To Order (MS Version)

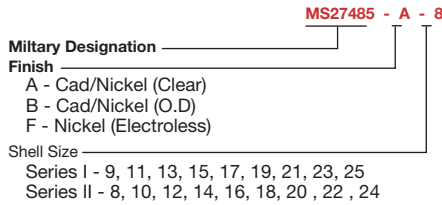

NOTE: When ordering the MS version you must specify both MS numbers for the Potting Boot and the Adapter Ring.

| Shell Size |           | MS27485 Part Number | Cannon Part Number | Finishes       |       |                    |             |        |   |
|------------|-----------|---------------------|--------------------|----------------|-------|--------------------|-------------|--------|---|
| Series I   | Series II |                     |                    | A              |       | B                  | N           | F      |   |
|            |           |                     |                    | Cadmium/Nickel | Clear | Cadmium/Nickel-O.D | Electroless | Nickel |   |
| 9          | 8         | 27485-*--**         | 237-0887-***       | -000           | MS    | MS                 | Cannon      | MS     |   |
| 11         | 10        | 27485-*--**         | 237-0874-***       | -000           | A     | -001               | B           | -002   | F |
| 13         | 12        | 27485-*--**         | 237-0875-***       | -000           | A     | -001               | B           | -002   | F |
| 15         | 14        | 27485-*--**         | 237-0876-***       | -000           | A     | -001               | B           | -002   | F |
| 17         | 16        | 27485-*--**         | 237-0877-***       | -000           | A     | -001               | B           | -002   | F |
| 19         | 18        | 27485-*--**         | 237-0878-***       | -000           | A     | -001               | B           | -002   | F |
| 21         | 20        | 27485-*--**         | 237-0879-***       | -000           | A     | -001               | B           | -002   | F |
| 23         | 22        | 27485-*--**         | 237-0880-***       | -000           | A     | -001               | B           | -003   | F |
| 25         | 24        | 27485-*--**         | 237-0881-***       | -000           | A     | -001               | B           | -003   | F |

\* MS Finish  
 \*\* Only even numbered shell size is applicable  
 \*\*\* Cannon Finish

## Wire Sealing Plugs

| Series III Size | Series I & II Size | Part Number  |              | Color Code |
|-----------------|--------------------|--------------|--------------|------------|
|                 |                    | Cannon       | MS27488      |            |
| 22D             | 22D                | 225-1013-000 | MS27488-22-2 | Black      |
| 20              | 20                 | 225-0070-000 | MS27488-20-2 | Red        |
| 16              | 16                 | 225-0104-000 | MS27488-16-2 | Green      |
| 12              | 12                 | 225-0105-000 | MS27488-12-2 | Orange     |

Wire sealing plugs meet MS27488 standards. The plugs are color coded according to size for easy identification. Wire sealing plugs may be ordered separately.



Dimensions shown in inches (mm)  
 Specifications and dimensions subject to change

www.ittcannon.com

## Cannon KJL/KJ/KJA/KJB MIL-DTL-38999 Series I, II, III Connectors

### Tools - Crimp



A

Circular



M22520/1-01                      CBT-530                      M22520/2-01                      CBT-565

| Contact Size            | Pin Contact Series I/II/III |                               | Socket Contact Series II |                               | Socket Contact Series I & III |                               |
|-------------------------|-----------------------------|-------------------------------|--------------------------|-------------------------------|-------------------------------|-------------------------------|
|                         | Crimp Tool Part Number      | Locator or Turret Part Number | Crimp Tool Part Number   | Locator or Turret Part Number | Crimp Tool Part Number        | Locator or Turret Part Number |
| 22D or 22M*             | M22520/2-01                 | M22520/2-09                   | M22520/2-01              | M22520/2-06                   | M22520/2-01                   | M22520/2-07                   |
| 22*                     | M22520/2-01                 | M22520/2-09                   | M22520/2-01              | M22520/2-06                   | M22520/2-01                   | M22520/2-07                   |
| 20                      | M22520/1-01                 | M22520/1-04 OR TH 187         | M22520/1-01              | M22520/1-04                   | M22520/1-01                   | M22520/1-04                   |
| 16                      | M22520/1-01                 | M22520/1-04 OR TH 187         | M22520/1-01              | M22520/1-04                   | M22520/1-01                   | M22520/1-04                   |
| 12                      | M22520/1-01                 | M22520/1-04                   | M22520/1-01              | M22520/1-04                   | M22520/1-01                   | M22520/1-04                   |
| 8 Coax Inner Conductor  | Crimp Tool                  | Crimp Tool Locator            | Outer Conductor          |                               | Crimp Tool                    | Crimp Tool Locator            |
| RG180                   | M22520/2-01                 | 995-0002-268                  | RG180                    |                               | M22520/5-01                   | M22520/5-39B                  |
| RG 174, 179, 316        | M22520/2-01                 | 995-0002-268                  | RG 174, 179, 316         |                               | M22520/5-01                   | M22520/5-37B                  |
| RG 142                  | M22520/2-01                 | 995-0002-268                  | RG 142                   |                               | M22520/5-01                   | M22520/5-19B                  |
| 12 Coax Inner Conductor | Crimp Tool                  | Crimp Tool Locator            | Outer Conductor          |                               | Crimp Tool                    | Crimp Tool Locator            |
| RG174, 179, 316         | M22520/2-01                 | M22520/2-34                   | RG174, 179, 316          |                               | M22520/31-01                  | M22520/31-02                  |
| 8 Twinax Center Contact | Crimp Tool                  | Crimp Tool Locator            |                          |                               |                               |                               |
| Intermediate Contact    | M22520/2-01                 | K709                          |                          |                               |                               |                               |
| Outer Contact           | M22520/5-01                 | Y631 Die Closure B            |                          |                               |                               |                               |
|                         | M22520/5-01                 | Y631 Die Closure A            |                          |                               |                               |                               |

\* For reference only

### Tools - Plastic



Insertion/Extraction

| Contact Size  | Cannon Description | Cannon Part Number | M81969 Part Number | Superseded Military Part Number | Insertion Color Tip | Extraction Color Tip |
|---------------|--------------------|--------------------|--------------------|---------------------------------|---------------------|----------------------|
| 22D           | CIET-22D-01        | 274-7048-000       | M81969/14-01       | MS27534-22D                     | Green               | White                |
| 22M*          | CIET-22D-01        | 274-7048-000       | M81969/14-01       | MS27534-22D                     | Green               | White                |
| 20            | CIET-20-10         | 274-7001-000       | M81969/14-10       | MS27534-20                      | Red                 | Orange               |
| 16            | CIET-16-03         | 274-7002-000       | M81969/14-03       | MS27534-16                      | Blue                | White                |
| 12            | CIET-12-04         | 274-7003-000       | M81969/14-04       | MS27534-12                      | Yellow              | White                |
| 8 Coax/Twinax | CET8-T             | 323-7004-001       | —                  | —                               | —                   | —                    |
| 12 Coax       | CIET-12-04         | 274-7003-000       | M81969/14-04       | M527534-12                      | Yellow              | White                |

Insertion tool not required for size 8

### Tools - Metal (MS)



Insertion

Extraction

| Contact Size | Insertion           |                        |            | Extraction          |                        |                 |                 |
|--------------|---------------------|------------------------|------------|---------------------|------------------------|-----------------|-----------------|
|              | MS27495 Part Number | ITT CANNON Part Number | Color Band | MS27495 Part Number | ITT CANNON Part Number | Color Band No.1 | Color Band No.2 |
| 22D OR 22M*  | MS27495 A22M        | 995-0001-718           | Black      | MS27495 R22M        | 995-0001-719           | Black           | White           |
| 22*          | MS27495 A22         | 995-0001-720           | Brown      | MS27495 R22         | 995-0001-721           | Brown           | White           |
| 20           | MS27495 A20         | 995-0001-716           | Red        | MS27495 R20         | 995-0001-717           | Red             | White           |
| 16           | MS27495 A16         | 995-0001-732           | Blue       | MS27495 R16         | 995-0001-731           | Blue            | White           |

Band No. 1 indicates tool size.  
Band No. 2 indicates removal tool.  
\* For reference only

Dimensions shown in inches (mm)  
Specifications and dimensions subject to change

www.ittcannon.com



# Cannon KJL/KJ/KJA/KJB MIL-DTL-38999 Series I, II, III Connectors

## Assembly Instructions



A

Circular

### Wire Stripping

Strip insulation from end of wire to be crimped. (See table for proper stripping dimensions.) Do not cut or damage wire strands.



| Wire Size   | A           |
|-------------|-------------|
| 22D or 22M* | .125 (3.18) |
| 20          | .188 (4.77) |
| 16          | .188 (4.77) |
| 12          | .188 (4.77) |

\* For reference only

### Contact Crimping

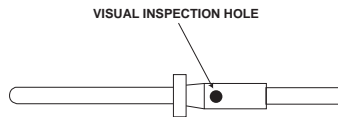

1. Insert stripped wire into contact crimp pot. Wire must be visible thru inspection hole.



2. Using correct crimp tool and locator, cycle the tool once to be sure the indentors are open. Insert contact and wire into locator. Squeeze tool handles firmly and completely to insure a proper crimp. The tool will not release unless the crimp indentors in the tool head have been fully actuated.



3. Release crimped contact and wire from tool. Be certain the wire is visible thru inspection hole in contact.

### Contact Insertion



1. Remove hardware from plug or receptacle and slip over wire bundle in proper order for reassembly.



2. Using proper plastic or metal insertion tool for corresponding contact, position wire in tip of the tool so that the tool tip butts up against the contact shoulder.



3. Press tool against contact shoulder and, with firm and even pressure, insert wired contact and tool tip into center contact cavity. A slight click may be heard as metal retaining tines snap into place behind contact shoulder.



4. Remove tool and pull back lightly on wire to make sure contact is properly seated. Repeat operation with remainder of contacts to be inserted, beginning with the center cavity and working outward in alternating rows.



5. After all contacts are inserted, fill any empty cavities with wire sealing plugs, Resemble plug or receptacle hardware.

### Contact Extraction

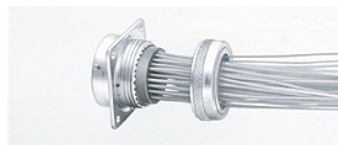

1. Remove hardware from plug or receptacle and slide hardware back along wire bundle.



2. Using plastic or metal extraction tool with proper color code corresponding to contact size, place wire in tool.



3. Insert tool into contact cavity until tool tip bottoms against the contact shoulder, expanding clip retaining tines.



4. Hold wire firmly in tool and extract wired contact and tool. Repeat operation for all contacts to be extracted.



5. Fill any empty wire cavities with wire sealing plugs, and



6. Reassemble plug or receptacle.



Dimensions shown in inches (mm)  
Specifications and dimensions subject to change

www.ittcannon.com



# Cannon KJL/KJ/KJA/KJB MIL-DTL-38999 Series I, II, III Connectors

## MIL-DTL-38999 Specifications



A

Circular

The following excerpts are some of the parameter requirements of the MIL-DTL-3899 Specification.

| Test Description           | Paragraph Reference                         | Requirements   |                            |   |            |                            |   |                      |   |      |                    |   |      |    |            |      |      |            |      |      |            |      |      |            |      |      |     |   |   |    |    |   |    |    |   |    |    |   |       |    |   |    |    |   |    |    |   |    |    |   |    |    |   |    |    |   |    |    |   |    |    |   |    |    |   |    |    |   |    |    |   |    |    |   |
|----------------------------|---|--|----------------------------|---|------------|----------------------------|---|----------------------|---|------|--------------------|---|------|----|------------|------|------|------------|------|------|------------|------|------|------------|------|------|-----|---|---|----|----|---|----|----|---|----|----|---|-------|----|---|----|----|---|----|----|---|----|----|---|----|----|---|----|----|---|----|----|---|----|----|---|----|----|---|----|----|---|----|----|---|----|----|---|
| Contact Retention          | 4 5 19                                      | After preloading to 3 pounds maximum, the force shall be applied at a rate of approximately 1 pound per second and maintained at full load for 5-10 seconds. No damage to contacts or insert shall result nor shall the contacts be dislocated from their normal position in the connector more than 0.012 inch under the given load. Failure to meet these requirements shall be cause for rejection.   |                            |   |            |                            |   |                      |   |      |                    |   |      |    |            |      |      |            |      |      |            |      |      |            |      |      |     |   |   |    |    |   |    |    |   |    |    |   |       |    |   |    |    |   |    |    |   |    |    |   |    |    |   |    |    |   |    |    |   |    |    |   |    |    |   |    |    |   |    |    |   |    |    |   |
|                            |   | <table border="1" style="width: 100%; border-collapse: collapse;"> <tr> <td style="text-align: center;">Contact Size</td> <td style="text-align: center;">22M*</td> <td style="text-align: center;">22D</td> <td style="text-align: center;">22*</td> <td style="text-align: center;">20</td> <td style="text-align: center;">18</td> </tr> <tr> <td style="text-align: center;">Loads in Pounds ± 10%</td> <td style="text-align: center;">10</td> <td style="text-align: center;">10</td> <td style="text-align: center;">10</td> <td style="text-align: center;">15</td> <td style="text-align: center;">25</td> </tr> </table>   | Contact Size               | 22M*  | 22D        | 22*                        | 20  | 18                   | Loads in Pounds ± 10%                       | 10   | 10                 | 10  | 15   | 25 |            |      |      |            |      |      |            |      |      |            |      |      |     |   |   |    |    |   |    |    |   |    |    |   |       |    |   |    |    |   |    |    |   |    |    |   |    |    |   |    |    |   |    |    |   |    |    |   |    |    |   |    |    |   |    |    |   |    |    |   |
|                            |   | Contact Size   | 22M*                       | 22D   | 22*        | 20                         | 18  |                      |   |      |                    |   |      |    |            |      |      |            |      |      |            |      |      |            |      |      |     |   |   |    |    |   |    |    |   |    |    |   |       |    |   |    |    |   |    |    |   |    |    |   |    |    |   |    |    |   |    |    |   |    |    |   |    |    |   |    |    |   |    |    |   |    |    |   |
| Loads in Pounds ± 10%      | 10  | 10   | 10                         | 15  | 25         |                            |   |                      |   |      |                    |   |      |    |            |      |      |            |      |      |            |      |      |            |      |      |     |   |   |    |    |   |    |    |   |    |    |   |       |    |   |    |    |   |    |    |   |    |    |   |    |    |   |    |    |   |    |    |   |    |    |   |    |    |   |    |    |   |    |    |   |    |    |   |
|                            |   |  |                            |   |            |                            |   |                      |   |      |                    |   |      |    |            |      |      |            |      |      |            |      |      |            |      |      |     |   |   |    |    |   |    |    |   |    |    |   |       |    |   |    |    |   |    |    |   |    |    |   |    |    |   |    |    |   |    |    |   |    |    |   |    |    |   |    |    |   |    |    |   |    |    |   |
| Coupling Torque            | 4 5 6                                       | For qualification testing, mating halves shall be coupled and uncoupled, measuring the torques necessary. The torques required to couple and uncouple mating connector halves shall fall within the limits specifications as follows:  |                            |   |            |                            |   |                      |   |      |                    |   |      |    |            |      |      |            |      |      |            |      |      |            |      |      |     |   |   |    |    |   |    |    |   |    |    |   |       |    |   |    |    |   |    |    |   |    |    |   |    |    |   |    |    |   |    |    |   |    |    |   |    |    |   |    |    |   |    |    |   |    |    |   |
|                            |   | <table border="1" style="width: 100%; border-collapse: collapse;"> <thead> <tr> <th colspan="3" style="text-align: center;">Torque</th> <th colspan="3" style="text-align: center;">Torque</th> <th colspan="3" style="text-align: center;">Torque</th> <th colspan="3" style="text-align: center;">Torque</th> </tr> <tr> <th style="text-align: center;">Shell Size</th> <th style="text-align: center;">Max.</th> <th style="text-align: center;">Min.</th> <th style="text-align: center;">Shell Size</th> <th style="text-align: center;">Max.</th> <th style="text-align: center;">Min.</th> <th style="text-align: center;">Shell Size</th> <th style="text-align: center;">Max.</th> <th style="text-align: center;">Min.</th> <th style="text-align: center;">Shell Size</th> <th style="text-align: center;">Max.</th> <th style="text-align: center;">Min.</th> </tr> </thead> <tbody> <tr> <td style="text-align: center;">8/9</td> <td style="text-align: center;">8</td> <td style="text-align: center;">2</td> <td style="text-align: center;">14</td> <td style="text-align: center;">20</td> <td style="text-align: center;">4</td> <td style="text-align: center;">18</td> <td style="text-align: center;">28</td> <td style="text-align: center;">5</td> <td style="text-align: center;">22</td> <td style="text-align: center;">36</td> <td style="text-align: center;">7</td> </tr> <tr> <td style="text-align: center;">10/11</td> <td style="text-align: center;">12</td> <td style="text-align: center;">2</td> <td style="text-align: center;">15</td> <td style="text-align: center;">20</td> <td style="text-align: center;">3</td> <td style="text-align: center;">19</td> <td style="text-align: center;">28</td> <td style="text-align: center;">3</td> <td style="text-align: center;">23</td> <td style="text-align: center;">36</td> <td style="text-align: center;">5</td> </tr> <tr> <td style="text-align: center;">12</td> <td style="text-align: center;">16</td> <td style="text-align: center;">2</td> <td style="text-align: center;">16</td> <td style="text-align: center;">24</td> <td style="text-align: center;">4</td> <td style="text-align: center;">20</td> <td style="text-align: center;">32</td> <td style="text-align: center;">6</td> <td style="text-align: center;">24</td> <td style="text-align: center;">36</td> <td style="text-align: center;">7</td> </tr> <tr> <td style="text-align: center;">13</td> <td style="text-align: center;">16</td> <td style="text-align: center;">2</td> <td style="text-align: center;">17</td> <td style="text-align: center;">24</td> <td style="text-align: center;">3</td> <td style="text-align: center;">21</td> <td style="text-align: center;">32</td> <td style="text-align: center;">5</td> <td style="text-align: center;">25</td> <td style="text-align: center;">40</td> <td style="text-align: center;">5</td> </tr> </tbody> </table> | Torque                     |   |            | Torque                     |   |                      | Torque                                      |      |                    | Torque                                      |      |    | Shell Size | Max. | Min. | Shell Size | Max. | Min. | Shell Size | Max. | Min. | Shell Size | Max. | Min. | 8/9 | 8 | 2 | 14 | 20 | 4 | 18 | 28 | 5 | 22 | 36 | 7 | 10/11 | 12 | 2 | 15 | 20 | 3 | 19 | 28 | 3 | 23 | 36 | 5 | 12 | 16 | 2 | 16 | 24 | 4 | 20 | 32 | 6 | 24 | 36 | 7 | 13 | 16 | 2 | 17 | 24 | 3 | 21 | 32 | 5 | 25 | 40 | 5 |
|                            |   | Torque   |                            |   | Torque     |                            |   | Torque               |   |      | Torque             |   |      |    |            |      |      |            |      |      |            |      |      |            |      |      |     |   |   |    |    |   |    |    |   |    |    |   |       |    |   |    |    |   |    |    |   |    |    |   |    |    |   |    |    |   |    |    |   |    |    |   |    |    |   |    |    |   |    |    |   |    |    |   |
|                            |   | Shell Size   | Max.                       | Min.  | Shell Size | Max.                       | Min.  | Shell Size           | Max.  | Min. | Shell Size         | Max.  | Min. |    |            |      |      |            |      |      |            |      |      |            |      |      |     |   |   |    |    |   |    |    |   |    |    |   |       |    |   |    |    |   |    |    |   |    |    |   |    |    |   |    |    |   |    |    |   |    |    |   |    |    |   |    |    |   |    |    |   |    |    |   |
|                            |   | 8/9  | 8                          | 2   | 14         | 20                         | 4   | 18                   | 28  | 5    | 22                 | 36  | 7    |    |            |      |      |            |      |      |            |      |      |            |      |      |     |   |   |    |    |   |    |    |   |    |    |   |       |    |   |    |    |   |    |    |   |    |    |   |    |    |   |    |    |   |    |    |   |    |    |   |    |    |   |    |    |   |    |    |   |    |    |   |
| 10/11                      | 12  | 2  | 15                         | 20  | 3          | 19                         | 28  | 3                    | 23  | 36   | 5                  |   |      |    |            |      |      |            |      |      |            |      |      |            |      |      |     |   |   |    |    |   |    |    |   |    |    |   |       |    |   |    |    |   |    |    |   |    |    |   |    |    |   |    |    |   |    |    |   |    |    |   |    |    |   |    |    |   |    |    |   |    |    |   |
| 12                         | 16  | 2  | 16                         | 24  | 4          | 20                         | 32  | 6                    | 24  | 36   | 7                  |   |      |    |            |      |      |            |      |      |            |      |      |            |      |      |     |   |   |    |    |   |    |    |   |    |    |   |       |    |   |    |    |   |    |    |   |    |    |   |    |    |   |    |    |   |    |    |   |    |    |   |    |    |   |    |    |   |    |    |   |    |    |   |
| 13                         | 16  | 2  | 17                         | 24  | 3          | 21                         | 32  | 5                    | 25  | 40   | 5                  |   |      |    |            |      |      |            |      |      |            |      |      |            |      |      |     |   |   |    |    |   |    |    |   |    |    |   |       |    |   |    |    |   |    |    |   |    |    |   |    |    |   |    |    |   |    |    |   |    |    |   |    |    |   |    |    |   |    |    |   |    |    |   |
|                            |   |  |                            |   |            |                            |   |                      |   |      |                    |   |      |    |            |      |      |            |      |      |            |      |      |            |      |      |     |   |   |    |    |   |    |    |   |    |    |   |       |    |   |    |    |   |    |    |   |    |    |   |    |    |   |    |    |   |    |    |   |    |    |   |    |    |   |    |    |   |    |    |   |    |    |   |
|                            |   |  |                            |   |            |                            |   |                      |   |      |                    |   |      |    |            |      |      |            |      |      |            |      |      |            |      |      |     |   |   |    |    |   |    |    |   |    |    |   |       |    |   |    |    |   |    |    |   |    |    |   |    |    |   |    |    |   |    |    |   |    |    |   |    |    |   |    |    |   |    |    |   |    |    |   |
|                            |   |  |                            |   |            |                            |   |                      |   |      |                    |   |      |    |            |      |      |            |      |      |            |      |      |            |      |      |     |   |   |    |    |   |    |    |   |    |    |   |       |    |   |    |    |   |    |    |   |    |    |   |    |    |   |    |    |   |    |    |   |    |    |   |    |    |   |    |    |   |    |    |   |    |    |   |
| Durability                 | 4 5 7                                       | Connector halves shall be mated and unmated 250 times for Series II with ground fingers and 500 times for Series I and III at a rate not exceeding 300 cycles per hour. The test may be performed by hand or by mechanical means, but the coupling ring shall be operated as in normal service. Failure to complete this test because of mechanical malfunction shall be cause for rejection.  |                            |   |            |                            |   |                      |   |      |                    |   |      |    |            |      |      |            |      |      |            |      |      |            |      |      |     |   |   |    |    |   |    |    |   |    |    |   |       |    |   |    |    |   |    |    |   |    |    |   |    |    |   |    |    |   |    |    |   |    |    |   |    |    |   |    |    |   |    |    |   |    |    |   |
| Insulation Resistance      | 4 5 9                                       | An insulation resistance test shall be performed on unmated connectors in accordance with MIL-STD-202, Method 302, Test condition B. Measurement shall be made between three pairs of adjacent contacts and the shell. Failure to meet the minimum requirement of 50,000 megohms for Classes E, P, F, R, and T shall be cause for rejection.   |                            |   |            |                            |   |                      |   |      |                    |   |      |    |            |      |      |            |      |      |            |      |      |            |      |      |     |   |   |    |    |   |    |    |   |    |    |   |       |    |   |    |    |   |    |    |   |    |    |   |    |    |   |    |    |   |    |    |   |    |    |   |    |    |   |    |    |   |    |    |   |    |    |   |
| Vibration                  | 4 5 22                                      | Wired, mated connectors shall be subjected to the vibration test of MIL-STD-202, Method 214, Test Condition II, except that the duration shall be one hour in each plane. Receptacles shall be mounted on the vibration fixture by normal means. All contacts shall be wired in a series circuit and 100-500 milliamperes of current shall be allowed to flow through the series circuit during vibration. Suitable means shall be employed to monitor the current flow and to indicate any discontinuity of more than 1 microsecond. The wire bundle shall be damped to the nonvibrating points at least 8 inches from the rear of the connector. Current discontinuity of 1 microsecond or more, disengagement of the mated connectors, evidence of cracking, breaking, or loosening of parts shall be cause for rejection.  |                            |   |            |                            |   |                      |   |      |                    |   |      |    |            |      |      |            |      |      |            |      |      |            |      |      |     |   |   |    |    |   |    |    |   |    |    |   |       |    |   |    |    |   |    |    |   |    |    |   |    |    |   |    |    |   |    |    |   |    |    |   |    |    |   |    |    |   |    |    |   |    |    |   |
| Shock                      | 4 5 23                                      | Wired mated connectors shall be subjected to one shock in each direction in each of three mutually perpendicular axes. The pulse shall be approximate half sine wave of 300g ± 15% magnitude with a duration of 3 ± 1 milliseconds. Receptacles shall be mounted on a shock fixture by normal means. All contacts shall be wired in a series circuit and 100-150 ma. of current shall flow through the series circuit during shock. Suitable means shall be employed to monitor the current flow and to indicate any discontinuity of more than 1 microsecond. The wire bundle shall be clamped to fixed points at least 8 inches from the rear of the connector. Current discontinuity of 1 microsecond or more, disengagement of the mated connectors, evidence of cracking, breaking, or loosening of parts shall be cause for rejection.   |                            |   |            |                            |   |                      |   |      |                    |   |      |    |            |      |      |            |      |      |            |      |      |            |      |      |     |   |   |    |    |   |    |    |   |    |    |   |       |    |   |    |    |   |    |    |   |    |    |   |    |    |   |    |    |   |    |    |   |    |    |   |    |    |   |    |    |   |    |    |   |    |    |   |
| Thermal Shock              | 4 5 4                                       | Unmated receptacles shall be subjected to 10 cycles of thermal shock in the following manner:<br>Step a The receptacle shall be suspended for 10 + 1 - 0 minutes in the center of a cold water bath with a volume of approximately one cubic foot. No dimension of the bath shall be less than 10 inches. The water temperature shall not exceed 4°C (39.20°F)<br>Step b The receptacle shall be suspended for 10 1 - 0 minutes in the center of a hot water bath with a volume of approximately one cubic foot. No dimension of the bath shall be less than 10 inches. The water temperature shall be not less than 94°C (201°F).<br>The time of transfer from one bath to the other shall not exceed 5 seconds. At the end of the tenth cycle, the receptacle shall have the excess moisture shaken off and shall then be dried in a forced air oven at 66±5°C for 15 ± 1 minutes. Any evidence of damage resulting from this test shall be cause for rejection.   |                            |   |            |                            |   |                      |   |      |                    |   |      |    |            |      |      |            |      |      |            |      |      |            |      |      |     |   |   |    |    |   |    |    |   |    |    |   |       |    |   |    |    |   |    |    |   |    |    |   |    |    |   |    |    |   |    |    |   |    |    |   |    |    |   |    |    |   |    |    |   |    |    |   |
| Altitude Immersion         | 4 5 8                                       | Mated connectors shall be placed in a container of water at approximately 20°C and placed in an altitude chamber. All wire ends shall be located within the chamber and exposed to the chamber atmosphere, but not submerged. The exposed wire ends shall not be sealed. A quantity of salt, 5 percent by weight, shall be added to make the water conductive. The chamber pressure shall then be reduced to approximately one inch of mercury and maintained for thirty minutes. The chamber pressure shall then be slowly returned to atmospheric. This shall be considered one cycle. Two additional cycles shall be performed. At the end of the last cycle, while the mated connectors are still submerged, the Insulation Resistance Test (room temperature), and the High Potential Test (sea level voltages) shall be performed upon the same circuits. Failure to meet an insulation resistance minimum of 2,000 megohms or any evidence of dielectric breakdown or -flashover shall be cause for rejection.  |                            |   |            |                            |   |                      |   |      |                    |   |      |    |            |      |      |            |      |      |            |      |      |            |      |      |     |   |   |    |    |   |    |    |   |    |    |   |       |    |   |    |    |   |    |    |   |    |    |   |    |    |   |    |    |   |    |    |   |    |    |   |    |    |   |    |    |   |    |    |   |    |    |   |
| Solvent Immersion          | 4 5 29                                      | Unmated connectors shall be immersed fully in the applicable fluid specified below for 20 hours. After removal from the fluid, each connector shall remain for one hour in free air at room temperature.<br>a.) Jet fuel JP-4 to MIL-J-5624 b.) Aircraft lubricating oil to MIL-L-9236   |                            |   |            |                            |   |                      |   |      |                    |   |      |    |            |      |      |            |      |      |            |      |      |            |      |      |     |   |   |    |    |   |    |    |   |    |    |   |       |    |   |    |    |   |    |    |   |    |    |   |    |    |   |    |    |   |    |    |   |    |    |   |    |    |   |    |    |   |    |    |   |    |    |   |
| Corrosion                  | 4 5 12                                      | Unmated connectors and individual contact samples shall be subjected to the soft spray of MIL-STD-202, Method 101, Test Condition 8 (tin plated, Class Y receptacles-24 hours). Immediately after exposure, the surfaces of the specimens shall be thoroughly washed in tap water and dried in a circulatory oven at a temperature of 38 ± 3°C (100°F) for a period of approximately 12 hours. Any exposure of basis metal as a result of this test, shall be cause for rejection.   |                            |   |            |                            |   |                      |   |      |                    |   |      |    |            |      |      |            |      |      |            |      |      |            |      |      |     |   |   |    |    |   |    |    |   |    |    |   |       |    |   |    |    |   |    |    |   |    |    |   |    |    |   |    |    |   |    |    |   |    |    |   |    |    |   |    |    |   |    |    |   |    |    |   |
| Dynamic Salt Spray         | 4 5 12 2                                    | (Series I and 11, finish B; Series III, class W). The wired assembled plugs and receptacles shall be mated and unmated 50 cycles at a rate of 300 cycles per hour maximum. The mating and unmating shall be accomplished so that the plug and receptacle are completely separated during each cycle. The connectors shall then be subjected to the salt spray test in accordance with method 1001 of MIL-STD- 1344. The connectors shall be tested for 452 hours mated followed by 48 hours unmated. After the salt spray exposure the remaining number of durability cycles specified in 4.7.7 shall be completed.  |                            |   |            |                            |   |                      |   |      |                    |   |      |    |            |      |      |            |      |      |            |      |      |            |      |      |     |   |   |    |    |   |    |    |   |    |    |   |       |    |   |    |    |   |    |    |   |    |    |   |    |    |   |    |    |   |    |    |   |    |    |   |    |    |   |    |    |   |    |    |   |    |    |   |
| Temperature Durability     | 4 5 33                                      | Wired rated connectors shall be subjected to the indicated ambient temperature for a period of 1,000 hours<br><table style="width: 100%; border: none;"> <tr> <td style="width: 50%; border: none;">Series I and II (finish A)</td> <td style="width: 25%; border: none; text-align: center;">150<sup>+3°</sup><sub>-0°C</sub> (302° F)</td> <td style="width: 5%; border: none;"></td> <td style="width: 20%; border: none;">Series I and II (finish B)</td> <td style="width: 20%; border: none; text-align: center;">175<sup>+3°</sup><sub>-0°C</sub> (347° F)</td> </tr> <tr> <td style="border: none;">Series III (class W)</td> <td style="border: none; text-align: center;">175<sup>+3°</sup><sub>-0°C</sub> (347° F)</td> <td style="border: none;"></td> <td style="border: none;">All other finishes</td> <td style="border: none; text-align: center;">200<sup>+3°</sup><sub>-0°C</sub> (392° F)</td> </tr> </table>   | Series I and II (finish A) | 150 <sup>+3°</sup> <sub>-0°C</sub> (302° F) |            | Series I and II (finish B) | 175 <sup>+3°</sup> <sub>-0°C</sub> (347° F) | Series III (class W) | 175 <sup>+3°</sup> <sub>-0°C</sub> (347° F) |      | All other finishes | 200 <sup>+3°</sup> <sub>-0°C</sub> (392° F) |      |    |            |      |      |            |      |      |            |      |      |            |      |      |     |   |   |    |    |   |    |    |   |    |    |   |       |    |   |    |    |   |    |    |   |    |    |   |    |    |   |    |    |   |    |    |   |    |    |   |    |    |   |    |    |   |    |    |   |    |    |   |
| Series I and II (finish A) | 150 <sup>+3°</sup> <sub>-0°C</sub> (302° F) |  | Series I and II (finish B) | 175 <sup>+3°</sup> <sub>-0°C</sub> (347° F) |            |                            |   |                      |   |      |                    |   |      |    |            |      |      |            |      |      |            |      |      |            |      |      |     |   |   |    |    |   |    |    |   |    |    |   |       |    |   |    |    |   |    |    |   |    |    |   |    |    |   |    |    |   |    |    |   |    |    |   |    |    |   |    |    |   |    |    |   |    |    |   |
| Series III (class W)       | 175 <sup>+3°</sup> <sub>-0°C</sub> (347° F) |  | All other finishes         | 200 <sup>+3°</sup> <sub>-0°C</sub> (392° F) |            |                            |   |                      |   |      |                    |   |      |    |            |      |      |            |      |      |            |      |      |            |      |      |     |   |   |    |    |   |    |    |   |    |    |   |       |    |   |    |    |   |    |    |   |    |    |   |    |    |   |    |    |   |    |    |   |    |    |   |    |    |   |    |    |   |    |    |   |    |    |   |

\* For reference only

Dimensions shown in inches (mm)  
 Specifications and dimensions subject to change

www.ittcannon.com



## X-ON Electronics

Largest Supplier of Electrical and Electronic Components

*Click to view similar products for [Circular MIL Spec Connector](#) category:*

*Click to view products by [ITT](#) manufacturer:*

Other Similar products are found below :

[89075GULPR](#) [0025-264-3014](#) [58-570121-04S](#) [58-584653-12P](#) [0134-213-1007](#) [0134-213-1208](#) [0134-213-2209](#) [0025-258-000](#) [60-042022-02P](#) [60-042022-19P](#) [60-042022-23P](#) [012-0467-000](#) [602GB06EG24-61SN](#) [0134-201-1207](#) [0134-207-2009](#) [0134-213-1006](#) [6104-207-2302](#) [6104-208-1902](#) [6131-202-19149P](#) [6131-204-21149P](#) [6131-207-13149P](#) [6131-208-13149P](#) [6131-209-17149P](#) [6131-210-11149P](#) [6131-211-19149P](#) [6131-216-19149P](#) [6131-220-25149P](#) [6131-259-11149P](#) [6131-259-21149P](#) [6131-259-23149P](#) [6131-263-19149P](#) [6131-265-17149P](#) [6131-265-19149P](#) [6134-203-21149](#) [CS3100A18-1P-472](#) [CS3100A-36-77S](#) [CS3101A36-79S-SR](#) [CS3102A-10SL-53P](#) [CS3102A10SL-64S](#) [CS3102A-20-15S](#) [CS3102A-22-70S](#) [CS3102A-24-79S](#) [CS3102A24-AJS](#) [CS3102A-32-17P](#) [CS3102A32-25S](#) [CS3106A10SL3S004](#) [CS3106A-18-73S](#) [CS3106A-28-20P](#) [CS3106A-32-82S](#) [CS3106A36-79P-SR](#)