



ITT

Interconnect Solutions
Canon, VEAM, BIW



Ensuring over **20 years**
of mission critical communication

between two worlds across

250,000,000 miles



Engineered for life

Environmental D D*D

D*D

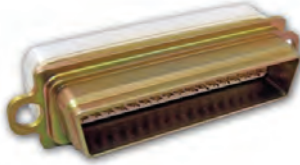

The Cannon D*D Environmental Series is designed to meet the demand for subminiature rectangular plugs with superior vibration and moisture resistance characteristics for aircraft, missile, and ground support equipment applications.

Featuring a rugged aluminum shell and peripheral seal, the D*D connector meets all applicable requirements of MIL-C-24308. Available in both sol-

der and crimp versions, all assemblies are provided with nylon potting cups and dust caps. Solder type contacts are non-removable and are factory-installed. Crimp type connectors utilize the field-proven LITTLE CAESAR® rear insertion, rear-release retention system.

PLEASE NOTE: The D*D Series is not intermateable with other D Subminiature connectors.

Performance and Material Specifications

Shell	Aluminum, cadmium plated with yellow chromate supplementary coating.
Contacts	Solder pot: Copper alloy, gold plated .00002 (.0005) over nickel .00004 (.0010) Crimp type: Copper alloy, gold plated .00002 (.0005) over nickel .00004 (.0010)
Contact Termination	Solder pot accommodating up to #20 AWG stranded wire. Crimp type accommodating #20, #22, and #24 AWG stranded wire.
Socket Type	Closed entry
Float Mounting Rivets & Washers	Stainless Steel. Passivated per DQ-P-35

0.0000
C

Test Data

Specifications	
Voltage Rating	All voltage figures are AC (rms), 60 Hz measured at approximately 25.0°C 50% RH.
Insulation Resistance (per MIL-C-24308)	Greater than 5,000 megohms, determined in accordance with MIL-STD-202A, Method 302
Contact Voltage Drop	2.67 millivolts, maximum, per amp
Contact Separation Force	1 to 8 ounces when tested in accordance with MIL-C-24308
Air Leakage	When properly wired and potted, 1 cubic inch of air per hour max. when subjected to 30 PSI pressure differential in accordance with MIL-C-50150, Paragraph 4.5.3.1
Vibration (per MIL-C-24308)	Exceeds test requirements of MIL-STD-202A, Method 204, Condition D
Corrosion Resistance (per MIL-C-24308)	Exceeds requirements of 50 hour exposure to salt spray in accordance with MIL-STD-202A, Method 101A, Condition B
Moisture Resistance (per MIL-C-24308)	Exceeds requirements of MIL-STD-202A, Method 106
Shock	Exceeds requirements of MIL-STD-202A, Method 213, Condition G
Environmental Seal	Effective from full engagement to 1/16 short of full engagement
Contact Retention Force	(Crimp type) 8 pounds (35.6 newtons) minimum for first cycle; 5 pounds (22.2 newtons) minimum after tenth cycle
Standard Layout Plugs	Measured from contact-to-contact, and contact-to-shell in unmated condition

ALTITUDE (FEET)

	Sea Level	20,000	50,000	70,000
Average Flashover	1700	1000	650	500
Test	1250	750	475	375

D Sub



Dimensions shown in inches (mm)
Specifications and dimensions subject to change

www.ittcannon.com

How to Order

Solder Cup Terminals

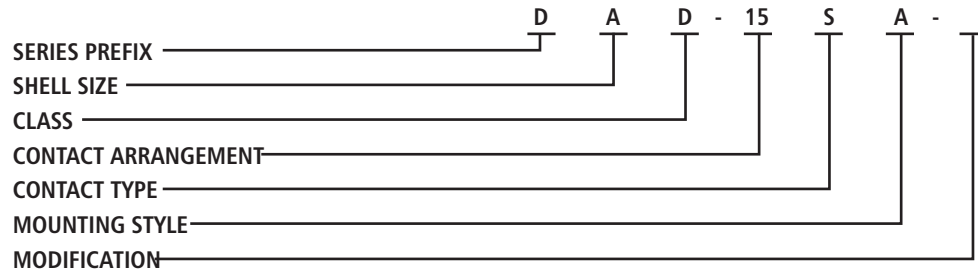

SERIES PREFIX
ITT Cannon Designation

SHELL SIZE
A, B, C, D, E

CONTACT TYPE
P – Pin
S – Socket

CLASS
D – Environmental

MOUNTING STYLE
A – Standard Mounting Holes
B – Float Mounts supplied

CONTACT ARRANGEMENT
9, 15, 25, 37, 50 Std Density
Combo-D Layouts also available

MODIFICATION
Contact factory

Snap-In Crimp Terminals

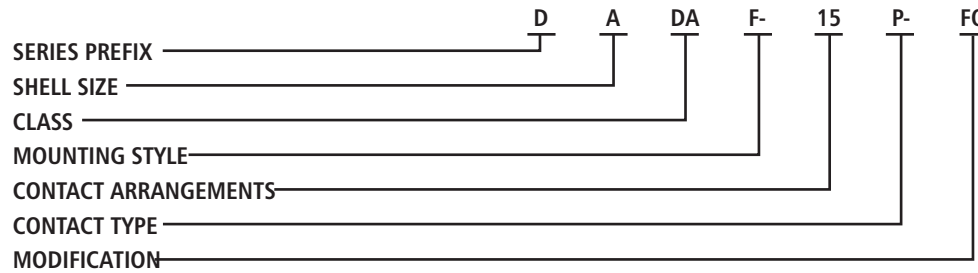

SERIES PREFIX
ITT Cannon Designation

SHELL SIZE
A, B, C, D, E

CONTACT ARRANGEMENTS
9, 15, 25, 37, 50 Std Density
15, 26, 44, 62, 88 Hi Density
Combo-D Layouts also available

CLASS
DA – Environmental, crimp type

CONTACT TYPE
P – Pin
S – Socket

MOUNTING STYLE
No Designator – Standard mounting
F – Float mounts supplied

MODIFICATION
FO – Connector supplied less contacts, for other modifications consult factory

Panel Cutouts

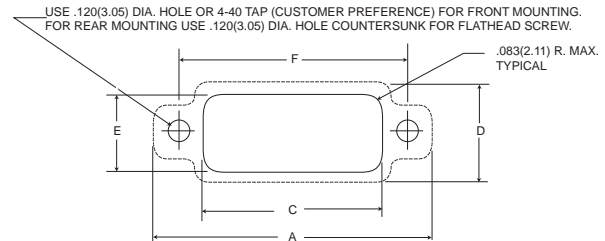

Add .032 (0.81) to dimensions C and E for float mounting.
Note: Panel cutout does not allow for potting cup clearance.

	A	C	D	E	F
Shell Size	±.010 (0.25)	Min.	±.010 (0.25)	±.010 (0.25)	±.010 (0.25)
DED-15	1.442 (36.63)	.839 (21.31)	.614 (15.60)	.497 (12.62)	1.125 (28.58)
DAD-26	1.755 (44.58)	1.157 (29.39)	.614 (15.60)	.497 (12.62)	1.437 (36.50)
DBD-44	2.295 (58.29)	1.697 (43.10)	.614 (15.60)	.497 (12.62)	1.993 (50.62)
DCD-62	2.937 (74.60)	2.357 (59.87)	.614 (15.60)	.497 (12.62)	2.625 (66.68)
DDD-78	2.859 (72.62)	2.265 (57.53)	.735 (18.67)	.610 (15.49)	2.531 (64.29)

Dimensions shown in inches (mm)
Specifications and dimensions subject to change

www.ittcannon.com

Environmental D D*D

Shell Dimensions, Standard Mount

Receptacle

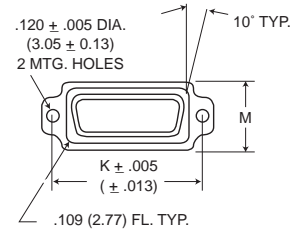
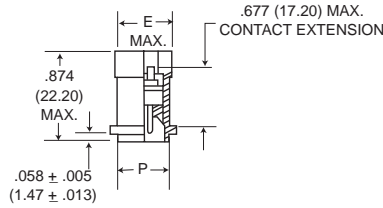
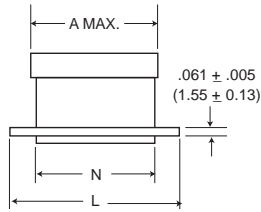

Plug

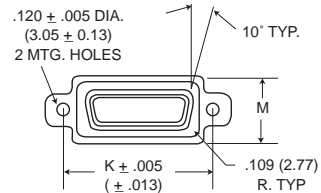
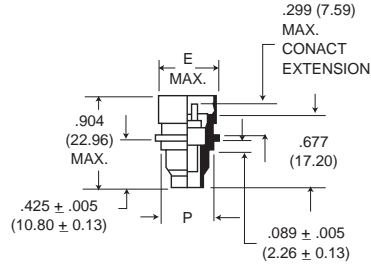
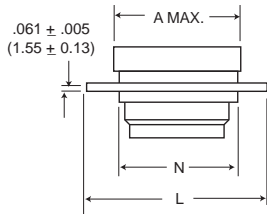

Float Mount Dimensions

Receptacle

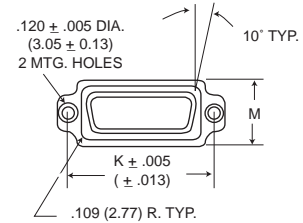
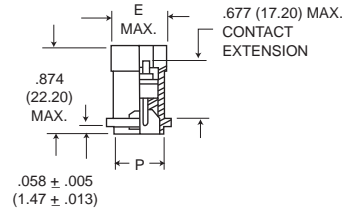
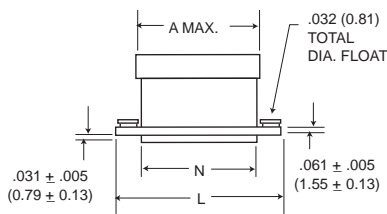

Plug

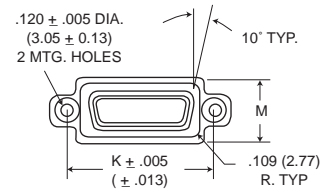
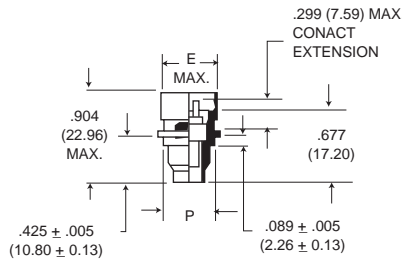
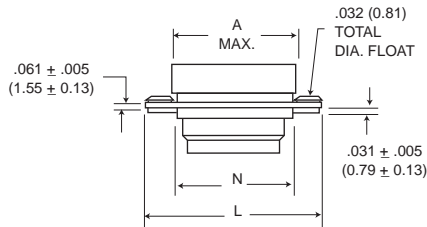

NOTE: All D*D Environmental plugs and receptacles are provided with dust caps and removable potting caps.

Shell Size	A Max.	E Max.	K ± .005 (0.13)	L ± .010 (0.25)	M ± .010 (0.25)	N ± .010 (0.25)	P ± .010 (0.25)
DED-9P, 15P	.915 (23.24)	.596 (15.14)	1.125 (28.58)	1.442 (36.63)	.614 (15.60)	.825 (20.86)	.483 (12.27)
DED-9S, 15S	.915 (23.24)	.596 (15.14)	1.125 (28.58)	1.442 (36.63)	.614 (15.60)	.825 (20.86)	.483 (12.27)
DAD-15P, 26P	1.233 (31.32)	.596 (15.14)	1.437 (36.50)	1.755 (44.58)	.614 (15.60)	1.143 (29.03)	.483 (12.27)
DAD-15S, 26S	1.233 (31.32)	.596 (15.14)	1.437 (36.50)	1.755 (44.58)	.614 (15.60)	1.143 (29.03)	.483 (12.27)
DBD-25P, 44P	1.786 (45.36)	.596 (15.14)	1.993 (50.62)	2.295 (58.29)	.614 (15.60)	1.683 (42.75)	.483 (12.27)
DBD-25S, 44S	1.786 (45.36)	.596 (15.14)	1.993 (50.62)	2.295 (58.29)	.614 (15.60)	1.683 (42.75)	.483 (12.27)
DCD-37P, 62P	2.458 (62.43)	.567 (14.40)	2.625 (66.68)	2.937 (74.60)	.614 (15.60)	2.343 (59.51)	.483 (12.27)
DCD-37S, 62S	2.458 (62.43)	.567 (14.40)	2.625 (66.68)	2.937 (74.60)	.614 (15.60)	2.343 (59.51)	.483 (12.27)
DDD-50P, 78P	2.390 (60.71)	.680 (17.12)	2.531 (64.29)	2.859 (72.62)	.735 (18.67)	2.251 (57.18)	.596 (15.14)
DDD-50S, 78S	2.390 (60.71)	.680 (17.12)	2.531 (64.29)	2.859 (72.62)	.735 (18.67)	2.251 (57.18)	.596 (15.14)

All tolerances are ± .010 (0.25) unless noted otherwise.



Dimensions shown in inches (mm)
Specifications and dimensions subject to change

www.ittcannon.com

**Combo D
Contact Cavity Arrangements**

Contact Cavity Arrangements

Plug

Face View Pin Insert
(Use a mirror image for receptacle).

Shell Size	E	E	E	A	A	A	A
Contact Arrangement	2W2	2WK2	5W1	3W3	3WK3	7W2	11W1
No. of Size 20 Cavities	0#20	0#20	4#20	0#20	0#20	5#20	10#20
No. of Size 8 Cavities	2#8	2#8	1#8	3#8	3#8	2#8	1#8

Shell Size	B	B	B
Contact Arrangement	5W54	9W4	13W3
No. of Size 20 Cavities	0#20	5#20	10#20
No. of Size 8 Cavities	5#8	4#8	3#8

Shell Size	B	B
Contact Arrangement	17W2	21W1
No. of Size 20 Cavities	15#20	20#20
No. of Size 8 Cavities	2#8	1#8

Shell Size	C	C	C
Contact Arrangement	8W8	13W6	17W5
No. of Size 20 Cavities	0#20	7#20	12#20
No. of Size 8 Cavities	8#8	6#8	5#8

Shell Size	C	C	C
Contact Arrangement	21WA4	25W3	27W2
No. of Size 20 Cavities	17#20	22#20	25#20
No. of Size 8 Cavities	4#8	3#8	2#8

Shell Size	D	D
Contact Arrangement	24W7	36W4
No. of Size 20 Cavities	17#20	32#20
No. of Size 8 Cavities	7#8	4#8

Shell Size	D	D
Contact Arrangement	43W2	47W1
No. of Size 20 Cavities	41#20	46#20
No. of Size 8 Cavities	2#8	1#8

Dimensions shown in inches (mm)
Specifications and dimensions subject to change

www.ittcannon.com



D Sub

Contact Cavities and Assembly Instructions

Contact Arrangements

Face View Pin Insert
(Use a mirror image for receptacle).

Shell Size
Contact Arrangement
Contact Size

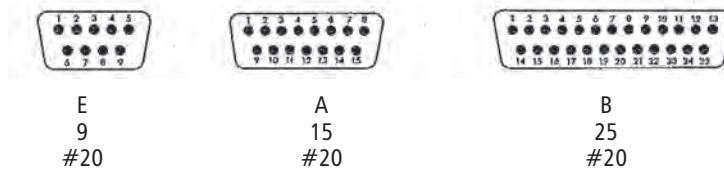

Standard Density



Face View Pin Insert
(Use a mirror image for receptacle).

Shell size
Contact Arrangement
Contact Size

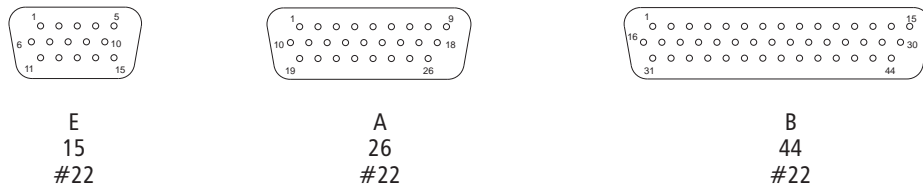

High Density

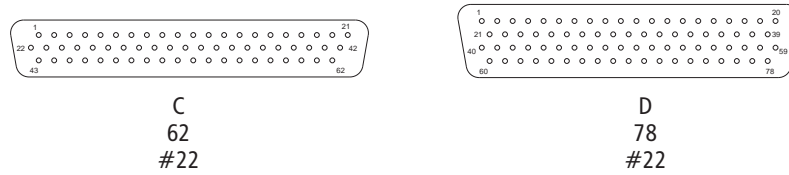

D Sub

Assembly Instructions

Wire-Stripping – Machine Contacts

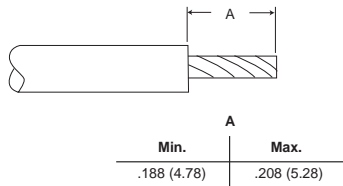

Contact Crimping



Contact Insertion



1. Cut wires to length. Strip insulation per above illustration. Check for frayed or broken wires.

2. Insert contact and wire into proper crimp tool (and locator, if required). Crimp contact to wire. Inspect crimp.

3. Center wired contact into groove of insertion tool with tool tip butting contact shoulder. Insert contact into cavity until a positive stop is felt. Inspect insertion.

Contact Extraction



4. To be sure contact is locked securely, pull back lightly on wire. Repeat for balance of contacts working row by row across the insulator.

5. Place wire into extraction tool tip.

6. Insert tool tip into contact cavity until tip bottoms against contact shoulder, releasing tines. Hold wire against tool with finger and remove tool and contact. Repeat for balance of contacts.



Dimensions shown in inches (mm)
Specifications and dimensions subject to change

www.ittcannon.com

D*M Standard Density Straight PCB Hole Pattern

Straight PCB Plug and Receptacle

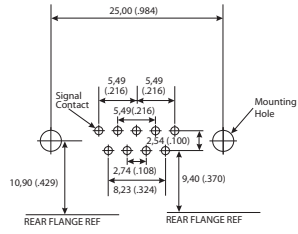

9 Contacts

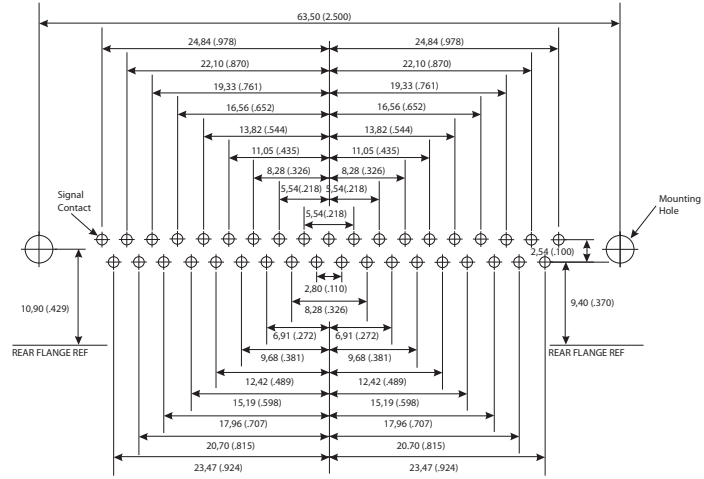

37 Contacts

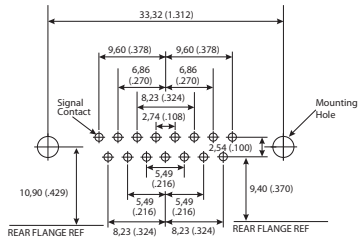

15 Contacts

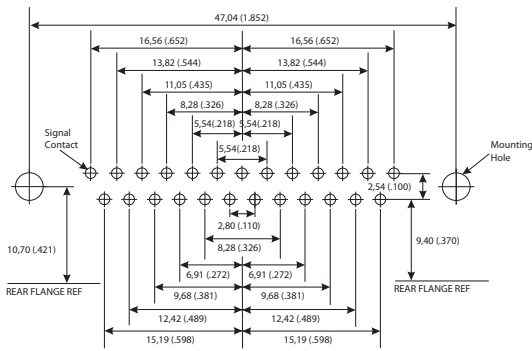

25 Contacts

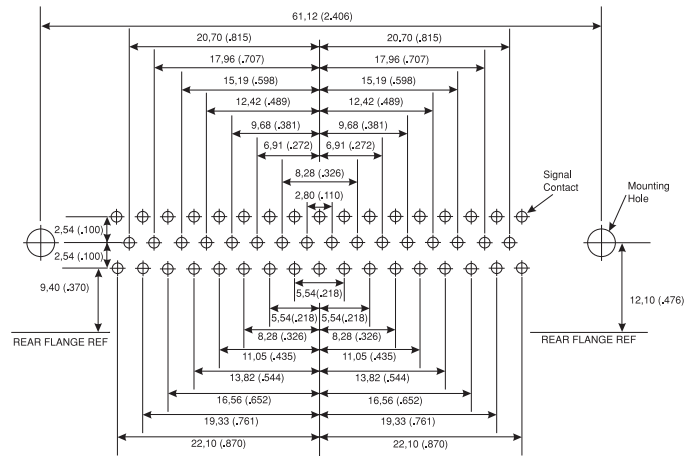

50 Contacts

Signal Contact	Recommended PCB Hole
0,60 (.024)	1,00 (.039)
Mounting Type	Recommended PCB Hole
Without Boardlock	3,05 (.120)
With Boardlock	3,10 (.122)

Dimensions shown in inches (mm)
 Specifications and dimensions subject to change
www.ittcannon.com



D Sub

90° D*M Standard Density

90° Plug and Receptacle

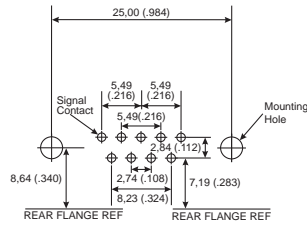

9 Contacts

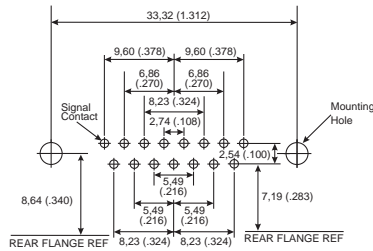

15 Contacts

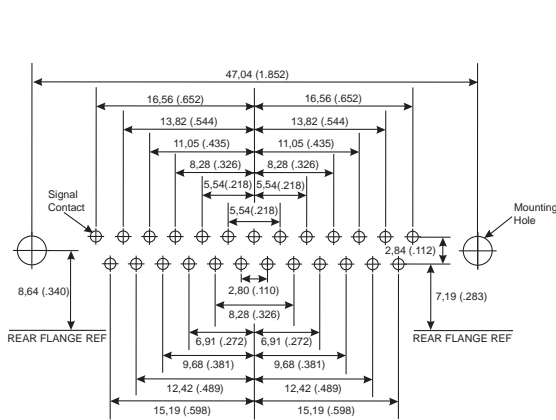

25 Contacts

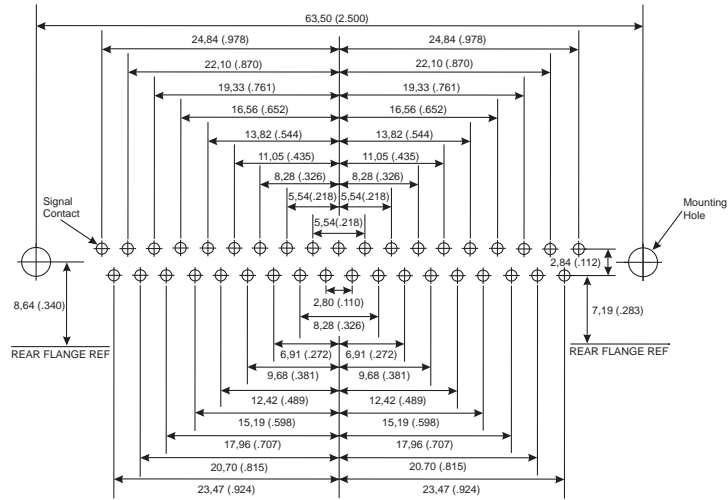

37 Contacts

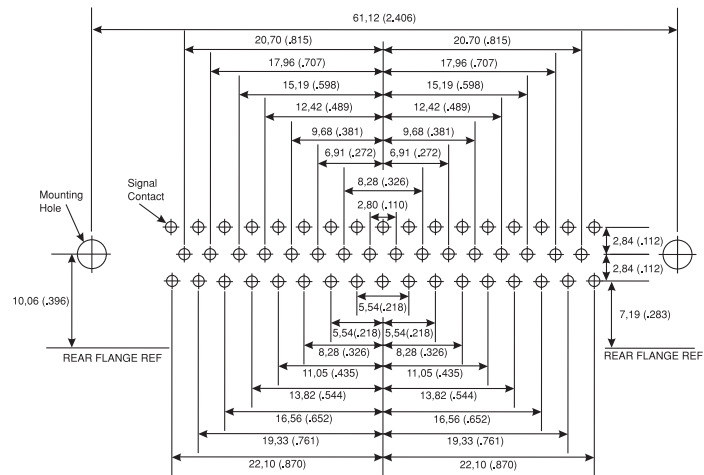

50 Contacts

Signal Contact	Recommended PCB Hole
0,76 (.030)	1,14 (.045)
1,00 (.040)	1,40 (.055)
Mounting Type	Recommended PCB Hole
Without Boardlock	3,05 (.120)
With Boardlock	3,10 (.122)

Dimensions shown in inches (mm)
Specifications and dimensions subject to change

www.ittcannon.com

D Sub



C



Straight PCB Hole Pattern

Face view, pin insert for plug
(use a mirror image for receptacle)

SIZE E
15 Contacts

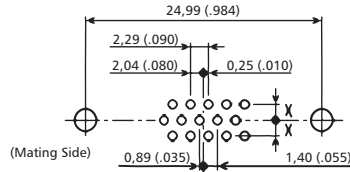

SIZE A
26 Contacts

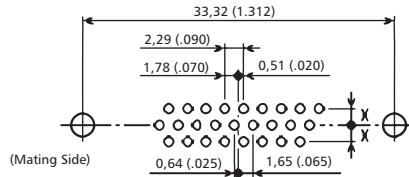

SIZE B
44 Contacts

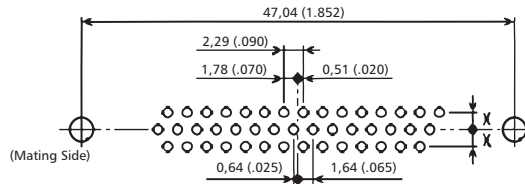

SIZE C
62 Contacts

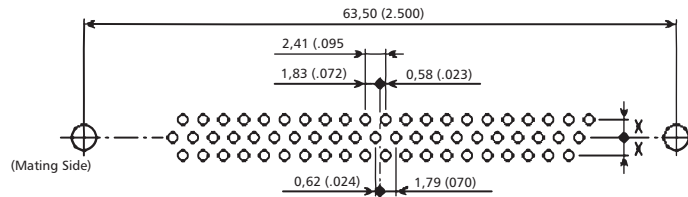

SIZE D
78 Contacts

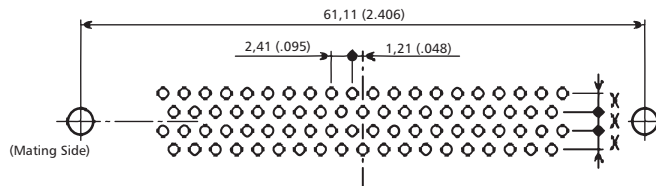

SIZE F
104 Contacts

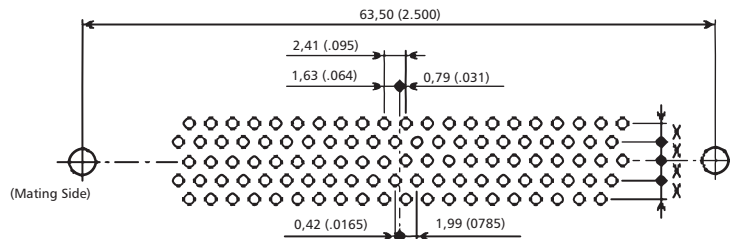

Dimension X
1,98 (.078) for sizes E, A, B, C
2,08 (.082) for size D

Recommended PC hole for signal contacts
? 0,90 (.035) min for terminations ? 0,51 (.020)
? 1,00 (.040) min for terminations ? 0,57 (.022)

Dimensions shown in inches (mm)
Specifications and dimensions subject to change

www.ittcannon.com

PCB Hole Pattern D*MA High Density

90° PCB Hole Pattern

Face view, pin insert for plug
(use a mirror image for receptacle)

SIZE E
15 Contacts

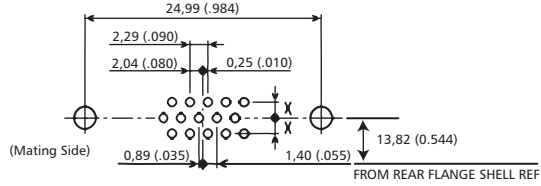

SIZE A
26 Contacts

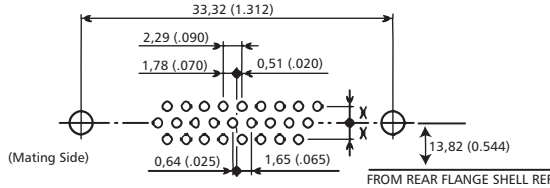

SIZE B
44 Contacts

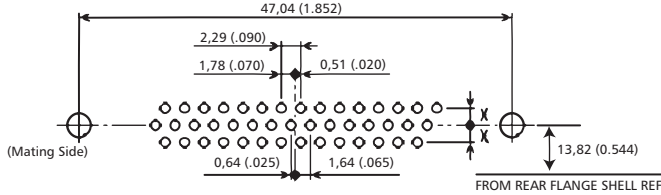

SIZE C
62 Contacts

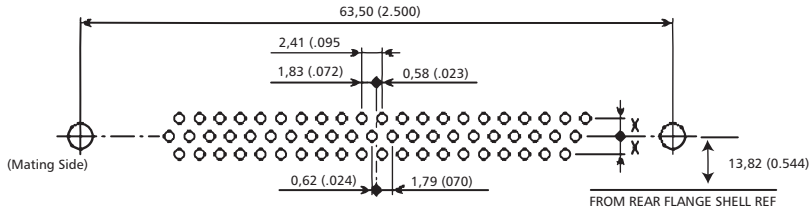

SIZE D
78 Contacts

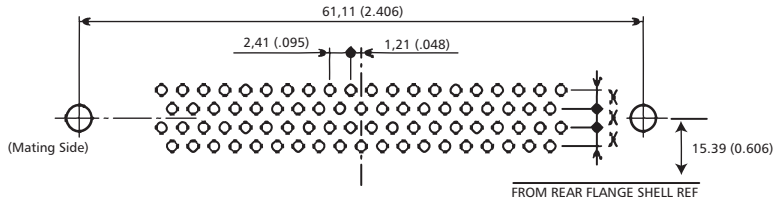

SIZE F
104 Contacts

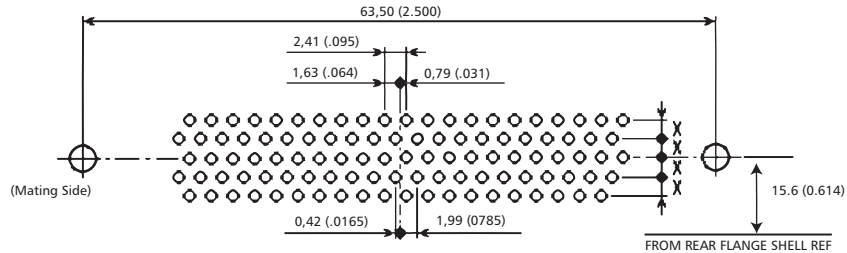

Dimension X
1,98 (.078) for sizes E, A, B, C
2,08 (.082) for size D

Recommended PC hole for signal contacts
? 0,90 (.035) min for terminations ? 0,51 (.020)
? 1,00 (.040) min for terminations ? 0,57 (.022)

Recommended PCB mounting hole
? 3.05 (.120)



Dimensions shown in inches (mm)
Specifications and dimensions subject to change

www.ittcannon.com

Standard Panel Cutouts

Panel Cutouts

Standard Cutout

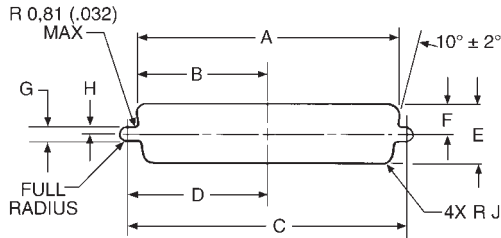

Rear Mounting Cutout (Optional)

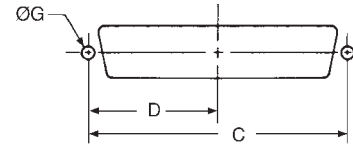

Front Panel Mounting

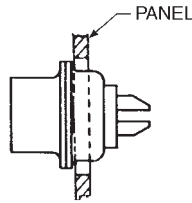

Standard Shell

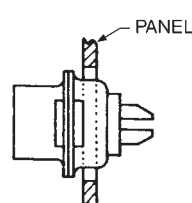

Dual Float Mount Shell

Rear Panel Mounting

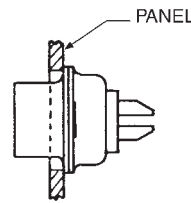

Standard Shell

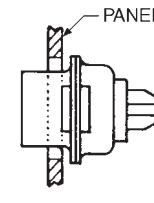

Dual Float Mount Shell

Standard Shell

Shell Size	Mounting Method	A	B	C	D	E	F	G	H	J
		± 0,13 (.005)	± 0,13 (.005)	± 0,13 (.005)	± 0,13 (.005)	± 0,13 (.005)	± 0,13 (.005)	± 0,05 (.002)	± 0,05 (.002)	± 0,05 (.002)
DE	Front	22,19 (.874)	11,09 (.437)	24,99 (.984)	12,49 (.492)	13,03 (.513)	6,52 (.257)	3,04 (.120)	1,52 (.060)	2,10 (.083)
	Rear	20,47 (.806)	10,23 (.403)	24,99 (.984)	12,49 (.492)	11,40 (.449)	5,71 (.225)	3,04 (.120)	1,52 (.060)	3,35 (.132)
DA	Front	30,53 (1.202)	15,26 (.601)	33,32 (1.312)	16,66 (.656)	13,03 (.513)	6,52 (.257)	3,04 (.120)	1,52 (.060)	2,10 (.083)
	Rear	28,80 (1.134)	14,40 (.567)	33,32 (1.312)	16,66 (.656)	11,40 (.449)	5,71 (.225)	3,04 (.120)	1,52 (.060)	3,35 (.132)
DB	Front	44,27 (1.743)	22,14 (.872)	47,04 (1.852)	23,52 (.926)	13,03 (.513)	6,52 (.257)	3,04 (.120)	1,52 (.060)	2,10 (.083)
	Rear	42,51 (1.674)	21,25 (.837)	47,04 (1.852)	23,52 (.926)	11,40 (.449)	5,71 (.225)	3,04 (.120)	1,52 (.060)	3,35 (.132)
DC	Front	60,73 (2.391)	30,37 (1.196)	63,50 (2.500)	31,75 (1.250)	13,03 (.513)	6,52 (.257)	3,04 (.120)	1,52 (.060)	2,10 (.083)
	Rear	59,08 (2.326)	29,54 (1.163)	63,50 (2.500)	31,75 (1.250)	11,40 (.449)	5,71 (.225)	3,04 (.120)	1,52 (.060)	3,35 (.132)
DD	Front	58,34 (2.297)	29,18 (1.149)	61,11 (2.406)	30,55 (1.203)	15,82 (.623)	7,92 (.312)	3,04 (.120)	1,52 (.060)	2,10 (.083)
	Rear	56,33 (2.218)	28,16 (1.109)	61,11 (2.406)	30,55 (1.203)	14,09 (.555)	7,06 (.278)	3,04 (.120)	1,52 (.060)	3,35 (.132)

Dual Float Mount Shell

Shell Size	Mounting Method	A	B	C	D	E	F	G	H	J
		± 0,13 (.005)	± 0,13 (.005)	± 0,13 (.005)	± 0,13 (.005)	± 0,13 (.005)	± 0,13 (.005)	± 0,05 (.002)	± 0,05 (.002)	± 0,05 (.002)
DE	Front	23,01 (.906)	11,50 (.453)	24,99 (.984)	12,49 (.492)	13,84 (.545)	6,93 (.273)	2,23 (.088)	1,11 (.044)	2,10 (.083)
	Rear	21,28 (.838)	10,64 (.419)	24,99 (.984)	12,49 (.492)	12,21 (.481)	6,12 (.241)	2,23 (.088)	1,11 (.044)	3,35 (.132)
DA	Front	31,34 (1.234)	15,67 (.617)	33,32 (1.312)	16,66 (.656)	13,84 (.545)	6,93 (.273)	2,23 (.088)	1,11 (.044)	2,10 (.083)
	Rear	29,61 (1.166)	14,80 (.583)	33,32 (1.312)	16,66 (.656)	12,21 (.481)	6,12 (.241)	2,23 (.088)	1,11 (.044)	3,35 (.132)
DB	Front	45,08 (1.775)	22,55 (.888)	47,04 (1.852)	23,52 (.926)	13,84 (.545)	6,93 (.273)	2,23 (.088)	1,11 (.044)	2,10 (.083)
	Rear	43,33 (1.706)	21,66 (.853)	47,04 (1.852)	23,52 (.926)	12,21 (.481)	6,12 (.241)	2,23 (.088)	1,11 (.044)	3,35 (.132)
DC	Front	61,54 (2.423)	30,78 (1.212)	63,50 (2.500)	31,75 (1.250)	13,84 (.545)	6,93 (.273)	2,23 (.088)	1,11 (.044)	2,10 (.083)
	Rear	59,79 (2.354)	29,89 (1.177)	63,50 (2.500)	31,75 (1.250)	12,21 (.481)	6,12 (.241)	2,23 (.088)	1,11 (.044)	3,35 (.132)
DD	Front	59,15 (2.329)	29,59 (1.165)	61,11 (2.406)	30,55 (1.203)	16,63 (.655)	8,33 (.328)	2,23 (.088)	1,11 (.044)	2,10 (.083)
	Rear	57,15 (2.250)	28,57 (1.125)	61,11 (2.406)	30,55 (1.203)	14,90 (.587)	7,46 (.294)	2,23 (.088)	1,11 (.044)	3,35 (.132)

Dimensions shown in inches (mm)
Specifications and dimensions subject to change

www.ittcannon.com



D Sub

M24308 Cross Reference

Gov't Designation	ITT Part Number
M24308/1-1Z	DEMAM9S
M24308/1-1F	DEMAM9S-A101
M24308/1-2Z	DAMM15S
M24308/1-2F	DAMM15S-A101
M24308/1-3Z	DBMM25S
M24308/1-3F	DBMM25S-A101
M24308/1-4Z	DCMM37S
M24308/1-4F	DCMM37S-A101
M24308/1-5Z	DDMM50S
M24308/1-5F	DDMM50S-A101
M24308/1-12Z	DEMMY9S
M24308/1-12F	DEMMY9S-A101
M24308/1-13Z	DAMMY15S
M24308/1-13F	DAMMY15S-A101
M24308/1-14Z	DBMMY25S
M24308/1-14F	DBMMY25S-A101
M24308/1-15Z	DCMMY37S
M24308/1-15F	DCMMY37S-A101
M24308/1-16Z	DDMMY50S
M24308/1-16F	DDMMY50S-A101
M24308/1-23Z	DEMMY9S
M24308/1-23F	DEMMY9S-A101
M24308/1-24Z	DAMMY15S
M24308/1-24F	DAMMY15S-A101
M24308/1-25Z	DBMMY25S
M24308/1-25F	DBMMY25S-A101
M24308/1-26Z	DCMMY37S
M24308/1-26F	DCMMY37S-A101
M24308/1-27Z	DDMMY50S
M24308/1-27F	DDMMY50S-A101
M24308/2-1Z	DEMAM9S
M24308/2-1F	DEMAM9S-A101
M24308/2-2Z	DAMAM15S
M24308/2-2F	DAMAM15S-A101
M24308/2-3Z	DCMAM25S
M24308/2-3F	DCMAM25S-A101
M24308/2-4Z	DCMAM37S
M24308/2-4F	DCMAM37S-A101
M24308/2-5Z	DDMAM50S
M24308/2-5F	DDMAM50S-A101
M24308/2-6Z	DEMAMT9S
M24308/2-6F	DEMAMT9S-A101
M24308/2-7Z	DAMAMT15S
M24308/2-7F	DAMAMT15S-A101
M24308/2-8Z	DBMAMT25S
M24308/2-8F	DBMAMT25S-A101
M24308/2-9Z	DCMAMT37S
M24308/2-9F	DCMAMT37S-A101
M24308/2-10Z	DDMAMT50S
M24308/2-10F	DDMAMT50S-A101
M24308/2-11Z	DEMAM15S
M24308/2-11F	DEMAM15S-A101
M24308/2-12Z	DAMAM26S
M24308/2-12F	DAMAM26S-A101
M24308/2-13Z	DBMAM44S
M24308/2-13F	DBMAM44S-A101
M24308/2-14Z	DCMAM62S
M24308/2-14F	DCMAM62S-A101

Gov't Designation	ITT Part Number
M24308/2-15Z	DDMAM78S
M24308/2-15F	DDMAM78S-A101
M24308/2-17Z	DEMAMT15S
M24308/2-17F	DEMAMT15S-A101
M24308/2-18Z	DAMAMT26S
M24308/2-18F	DAMAMT26S-A101
M24308/2-19Z	DBMAMT44S
M24308/2-19F	DBMAMT44S-A101
M24308/2-20Z	DCMAMT62S
M24308/2-20F	DCMAMT62S-A101
M24308/2-21Z	DDMAMT78S
M24308/2-21F	DDMAMT78S-A101
M24308/2-23Z	DEMAMY9S
M24308/2-23F	DEMAMY9S-A101
M24308/2-24Z	DAMAMY15S
M24308/2-24F	DAMAMY15S-A101
M24308/2-25Z	DBMAMY25S
M24308/2-25F	DBMAMY25S-A101
M24308/2-26Z	DCMAMY37S
M24308/2-26F	DCMAMY37S-A101
M24308/2-27Z	DDMAMY50S
M24308/2-27F	DDMAMY50S-A101
M24308/2-28Z	DEMAMY15S
M24308/2-28F	DEMAMY15S-A101
M24308/2-29Z	DAMAMY26S
M24308/2-29F	DAMAMY26S-A101
M24308/2-30Z	DBMAMY44S
M24308/2-30F	DBMAMY44S-A101
M24308/2-31Z	DCMAMY62S
M24308/2-31F	DCMAMY62S-A101
M24308/2-32Z	DDMAMY78S
M24308/2-32F	DDMAMY78S-A101
M24308/2-34Z	DEMAMYT9S
M24308/2-34F	DEMAMYT9S-A101
M24308/2-35Z	DAMAMYT15S
M24308/2-35F	DAMAMYT15S-A101
M24308/2-36Z	DBMAMYT25S
M24308/2-36F	DBMAMYT25S-A101
M24308/2-37Z	DCMAMYT37S
M24308/2-37F	DCMAMYT37S-A101
M24308/2-38Z	DDMAMYT50S
M24308/2-38F	DDMAMYT50S-A101
M24308/2-39Z	DEMAMYT15S
M24308/2-39F	DEMAMYT15S-A101
M24308/2-40Z	DAMAMYT26S
M24308/2-40F	DAMAMYT26S-A101
M24308/2-41Z	DBMAMYT44S
M24308/2-41F	DBMAMYT44S-A101
M24308/2-42Z	DCMAMYT62S
M24308/2-42F	DCMAMYT62S-A101
M24308/2-43Z	DDMAMYT78S
M24308/2-43F	DDMAMYT78S-A101
M24308/2-281Z	DEMAM9S-FO
M24308/2-281F	DEMAM9S-A101-FO
M24308/2-282Z	DAMAM15S-FO
M24308/2-282F	DAMAM15S-A101-FO
M24308/2-283Z	DBMAM25S-FO
M24308/2-283F	DBMAM25S-A101-FO

Gov't Designation	ITT Part Number
M24308/2-284Z	DCMAM37S-FO
M24308/2-284F	DCMAM37S-A101-FO
M24308/2-285Z	DDMAM50S-FO
M24308/2-285F	DDMAM50S-A101-FO
M24308/2-286Z	DEMAM15S-FO
M24308/2-286F	DEMAM15S-A101-FO
M24308/2-287Z	DAMAM26S-FO
M24308/2-287F	DAMAM26S-A101-FO
M24308/2-288Z	DBMAM44S-FO
M24308/2-288F	DBMAM44S-A101-FO
M24308/2-289Z	DCMAM62S-FO
M24308/2-289F	DCMAM62S-A101-FO
M24308/2-290Z	DDMAM78S-FO
M24308/2-290F	DDMAM78S-A101-FO
M24308/2-292Z	DEMAMY9S-FO
M24308/2-292F	DEMAMY9S-A101-FO
M24308/2-293Z	DAMAMY15S-FO
M24308/2-293F	DAMAMY15S-A101-FO
M24308/2-294Z	DBMAMY25S-FO
M24308/2-294F	DBMAMY25S-A101-FO
M24308/2-295Z	DCMAMY37S-FO
M24308/2-295F	DCMAMY37S-A101-FO
M24308/2-296Z	DDMAMY50S-FO
M24308/2-296F	DDMAMY50S-A101-FO
M24308/2-297Z	DEMAMY15S-FO
M24308/2-297F	DEMAMY15S-A101-FO
M24308/2-298Z	DAMAMY26S-FO
M24308/2-298F	DAMAMY26S-A101-FO
M24308/2-299Z	DBMAMY44S-FO
M24308/2-299F	DBMAMY44S-A101-FO
M24308/2-300Z	DCMAMY62S-FO
M24308/2-300F	DCMAMY62S-A101-FO
M24308/2-301Z	DDMAMY78S-FO
M24308/2-301F	DDMAMY78S-A101-FO
M24308/2-335Z	DBMAMY25S
M24308/2-335F	DBMAMY25S-A101
M24308/2-336Z	DCMAMY37S
M24308/2-336F	DCMAMY37S-A101
M24308/2-341Z	DAMAMY15S
M24308/2-341F	DAMAMY15S-A101
M24308/2-342Z	DEMAMY9S
M24308/2-342F	DEMAMY9S-A101
M24308/2-343Z	DAMAMY15S
M24308/2-343F	DAMAMY15S-A101
M24308/2-344Z	DBMAMY25S
M24308/2-344F	DBMAMY25S-A101
M24308/2-345Z	DCMAMY37S
M24308/2-345F	DCMAMY37S-A101
M24308/2-346Z	DDMAMY50S
M24308/2-346F	DDMAMY50S-A101
M24308/2-347Z	DEMAMY15S
M24308/2-347F	DEMAMY15S-A101
M24308/2-348Z	DAMAMY26S
M24308/2-348F	DAMAMY26S-A101
M24308/2-349Z	DBMAMY44S
M24308/2-349F	DBMAMY44S-A101
M24308/2-350Z	DCMAMY62S
M24308/2-350F	DCMAMY62S-A101

D Sub



Dimensions shown in inches (mm)
Specifications and dimensions subject to change

www.ittcannon.com

M24308 Cross Reference

Gov't Designation	ITT Part Number
M24308/2-351Z	DDMAMY78S
M24308/2-351F	DDMAMY78S-A101
M24308/2-353Z	DEMAMYT9S
M24308/2-353F	DEMAMYT9S-A101
M24308/2-354Z	DAMAMYT15S
M24308/2-354F	DAMAMYT15S-A101
M24308/2-355Z	DBMAMYT25S
M24308/2-355F	DBMAMYT25S-A101
M24308/2-356Z	DCMAMYT37S
M24308/2-356F	DCMAMYT37S-A101
M24308/2-357Z	DDMAMYT50S
M24308/2-357F	DDMAMYT50S-A101
M24308/2-358Z	DEMAMYT15S
M24308/2-358F	DEMAMYT15S-A101
M24308/2-359Z	DAMAMYT26S
M24308/2-359F	DAMAMYT26S-A101
M24308/2-360Z	DBMAMYT44S
M24308/2-360F	DBMAMYT44S-A101
M24308/2-361Z	DCMAMYT62S
M24308/2-361F	DCMAMYT62S-A101
M24308/2-362Z	DDMAMYT78S
M24308/2-362F	DDMAMYT78S-A101
M24308/2-482Z	DEMAMY9S-FO
M24308/2-482F	DEMAMY9S-A101-FO
M24308/2-483Z	DAMAMY15-S-FO
M24308/2-483F	DAMAMY15-S-A101-FO
M24308/2-484Z	DBMAMY25S-FO
M24308/2-484F	DBMAMY25S-A101-FO
M24308/2-485Z	DCMAMY37S-FO
M24308/2-485F	DCMAMY37S-A101-FO
M24308/2-486Z	DDMAMY50S-FO
M24308/2-486F	DDMAMY50S-A101-FO
M24308/2-487Z	DEMAMY15S-FO
M24308/2-487F	DEMAMY15S-A101-FO
M24308/2-488Z	DAMAMY26S-FO
M24308/2-488F	DAMAMY26S-A101-FO
M24308/2-489Z	DBMAMY44S-FO
M24308/2-489F	DBMAMY44S-A101-FO
M24308/2-490Z	DCMAMY62S-FO
M24308/2-490F	DCMAMY62S-A101-FO
M24308/2-491Z	DDMAMY78S-FO
M24308/2-491F	DDMAMY78S-A101-FO
M24308/2-509Z	DBMAMY25S
M24308/2-509F	DBMAMY25S-A101
M24308/2-510Z	DCMAMY37S
M24308/2-510F	DCMAMY37S-A101
M24308/2-515Z	DAMAMY15S
M24308/2-515F	DAMAMY15S-A101
M24308/3-1Z	DEMAM9P
M24308/3-1F	DEMAM9P-A101
M24308/3-2Z	DAMAM15P
M24308/3-2F	DAMAM15P-A101
M24308/3-3Z	DBMAM25P
M24308/3-3F	DBMAM25P-A101
M24308/3-4Z	DCMAM37P
M24308/3-4F	DCMAM37P-A101
M24308/3-5Z	DDMM50P
M24308/3-5F	DDMM50P-A101

Gov't Designation	ITT Part Number
M24308/3-12Z	DEMAMY9P
M24308/3-12F	DEMAMY9P-A101
M24308/3-13Z	DAMMY-15P
M24308/3-13F	DAMMY-15P-A101
M24308/3-14Z	DBMMY-25P
M24308/3-14F	DBMMY-25P-A101
M24308/3-15Z	DCMMY-37P
M24308/3-15F	DCMMY-37P-A101
M24308/3-16Z	DDMMY-50P
M24308/3-16F	DDMMY-50P-A101
M24308/3-17Z	DEMAMY9P
M24308/3-17F	DEMAMY9P-A101
M24308/3-18Z	DAMMY-15P
M24308/3-18F	DAMMY-15P-A101
M24308/3-19Z	DBMMY-25P
M24308/3-19F	DBMMY-25P-A101
M24308/3-20Z	DCMMY-37P
M24308/3-20F	DCMMY-37P-A101
M24308/3-21Z	DDMMY-50P
M24308/3-21F	DDMMY-50P-A101
M24308/4-1Z	DEMAM9P
M24308/4-1F	DEMAM9P-A101
M24308/4-2Z	DAMAM15P
M24308/4-2F	DAMAM15P-A101
M24308/4-3Z	DBMAM25P
M24308/4-3F	DBMAM25P-A101
M24308/4-4Z	DCMAM37P
M24308/4-4F	DCMAM37P-A101
M24308/4-5Z	DDMAM50P
M24308/4-5F	DDMAM50P-A101
M24308/4-6Z	DEMAMT9P
M24308/4-6F	DEMAMT9P-A101
M24308/4-7Z	DAMAMT15P
M24308/4-7F	DAMAMT15P-A101
M24308/4-8Z	DBMAMT25P
M24308/4-8F	DBMAMT25P-A101
M24308/4-9Z	DCMAMT37P
M24308/4-9F	DCMAMT37P-A101
M24308/4-10Z	DDMAMT50P
M24308/4-10F	DDMAMT50P-A101
M24308/4-11Z	DEMAM15P
M24308/4-11F	DEMAM15P-A101
M24308/4-12Z	DAMAM26P
M24308/4-12F	DAMAM26P-A101
M24308/4-13Z	DBMAM44P
M24308/4-13F	DBMAM44P-A101
M24308/4-14Z	DCMAM62P
M24308/4-14F	DCMAM62P-A101
M24308/4-15Z	DDMAM78P
M24308/4-15F	DDMAM78P-A101
M24308/4-17Z	DEMAMT15P
M24308/4-17F	DEMAMT15P-A101
M24308/4-18Z	DAMAMT26P
M24308/4-18F	DAMAMT26P-A101
M24308/4-19Z	DBMAMT44P
M24308/4-19F	DBMAMT44P-A101
M24308/4-20Z	DCMAMT62P
M24308/4-20F	DCMAMT62P-A101

Gov't Designation	ITT Part Number
M24308/4-21Z	DDMAMT78P
M24308/4-21F	DDMAMT78P-A101
M24308/4-259Z	DEMAM9P-FO
M24308/4-259F	DEMAM9P-A101-FO
M24308/4-260Z	DAMAM15P-FO
M24308/4-260F	DAMAM15P-A101-FO
M24308/4-261Z	DBMAM25P-FO
M24308/4-261F	DBMAM25P-A101-FO
M24308/4-262Z	DCMAM37P-FO
M24308/4-262F	DCMAM37P-A101-FO
M24308/4-263Z	DDMAM50P-FO
M24308/4-263F	DDMAM50P-A101-FO
M24308/4-264Z	DEMAM15P-FO
M24308/4-264F	DEMAM15P-A101-FO
M24308/4-265Z	DAMAM26P-FO
M24308/4-265F	DAMAM26P-A101-FO
M24308/4-266Z	DBMAM44P-FO
M24308/4-266F	DBMAM44P-A101-FO
M24308/4-267Z	DCMAM62P-FO
M24308/4-267F	DCMAM62P-A101-FO
M24308/4-268Z	DDMAM78P-FO
M24308/4-268F	DDMAM78P-A101-FO
M24308/4-302Z	DEMAMY9P
M24308/4-302F	DEMAMY9P-A101
M24308/4-303Z	DAMAMY15P
M24308/4-303F	DAMAMY15P-A101
M24308/4-304Z	DBMAMY25P
M24308/4-304F	DBMAMY25P-A101
M24308/4-305Z	DCMAMY37P
M24308/4-305F	DCMAMY37P-A101
M24308/4-306Z	DDMAMY50P
M24308/4-306F	DDMAMY50P-A101
M24308/4-307Z	DEMAMY15P
M24308/4-307F	DEMAMY15P-A101
M24308/4-308Z	DAMAMY26P
M24308/4-308F	DAMAMY26P-A101
M24308/4-309Z	DBMAMY44P
M24308/4-309F	DBMAMY44P-A101
M24308/4-310Z	DCMAMY62P
M24308/4-310F	DCMAMY62P-A101
M24308/4-311Z	DDMAMY78P
M24308/4-311F	DDMAMY78P-A101
M24308/4-313Z	DEMAMYT9P
M24308/4-313F	DEMAMYT9P-A101
M24308/4-314Z	DAMAMYT15P
M24308/4-314F	DAMAMYT15P-A101
M24308/4-315Z	DBMAMYT25P
M24308/4-315F	DBMAMYT25P-A101
M24308/4-316Z	DCMAMYT37P
M24308/4-316F	DCMAMYT37P-A101
M24308/4-317Z	DDMAMYT50P
M24308/4-317F	DDMAMYT50P-A101
M24308/4-318Z	DEMAMYT15P
M24308/4-318F	DEMAMYT15P-A101
M24308/4-319Z	DAMAMYT26P
M24308/4-319F	DAMAMYT26P-A101
M24308/4-320Z	DBMAMYT44P
M24308/4-320F	DBMAMYT44P-A101



Sub D

Dimensions shown in inches (mm)
 Specifications and dimensions subject to change

www.ittcannon.com



M24308 Cross Reference

Gov't Designation	ITT Part Number
M24308/4-321Z	DCMAMYT62P
M24308/4-321F	DCMAMYT62P-A101
M24308/4-322Z	DDMAMYT78P
M24308/4-322F	DDMAMYT78P-A101
M24308/4-324Z	DEMAMY9PFO
M24308/4-324F	DEMAMY9P-A101-FO
M24308/4-325Z	DAMAMY15PFO
M24308/4-325F	DAMAMY15P-A101-FO
M24308/4-326Z	DBMAMY25PFO
M24308/4-326F	DBMAMY25P-A101-FO
M24308/4-327Z	DCMAMY37PFO
M24308/4-327F	DCMAMY37P-A101-FO
M24308/4-328Z	DDMAMY50PFO
M24308/4-328F	DDMAMY50P-A101-FO
M24308/4-329Z	DEMAMY15P-FO
M24308/4-329F	DEMAMY15P-A101-FO
M24308/4-330Z	DAMAMY26P-FO
M24308/4-330F	DAMAMY26P-A101-FO
M24308/4-331Z	DBMAMY44P-FO
M24308/4-331F	DBMAMY44P-A101-FO
M24308/4-332Z	DCMAMY62P-FO
M24308/4-332F	DCMAMY62P-A101-FO
M24308/4-333Z	DDMAMY78P-FO
M24308/4-333F	DDMAMY78P-A101-FO
M24308/4-435Z	DEMAMY9P
M24308/4-435F	DEMAMY9P-A101
M24308/4-436Z	DAMAMY15P
M24308/4-436F	DAMAMY15P-A101
M24308/4-437Z	DBMAMY25P
M24308/4-437F	DBMAMY25P-A101
M24308/4-438Z	DCMAMY37P
M24308/4-438F	DCMAMY37P-A101
M24308/4-439Z	DDMAMY50P
M24308/4-439F	DDMAMY50P-A101
M24308/4-440Z	DEMAMY15P
M24308/4-440F	DEMAMY15P-A101
M24308/4-441Z	DAMAMY26P
M24308/4-441F	DAMAMY26P-A101
M24308/4-442Z	DBMAMY44P
M24308/4-442F	DBMAMY44P-A101
M24308/4-443Z	DCMAMY62P
M24308/4-443F	DCMAMY62P-A101
M24308/4-444Z	DDMAMY78P
M24308/4-444F	DDMAMY78P-A101
M24308/4-446Z	DEMAMY9P
M24308/4-446F	DEMAMY9P-A101
M24308/4-447Z	DAMAMYT15P
M24308/4-447F	DAMAMYT15P-A101
M24308/4-448Z	DBMAMYT25P
M24308/4-448F	DBMAMYT25P-A101
M24308/4-449Z	DCMAMYT37P
M24308/4-449F	DCMAMYT37P-A101
M24308/4-450Z	DDMAMY50P
M24308/4-450F	DDMAMY50P-A101
M24308/4-451Z	DEMAMYT15P
M24308/4-451F	DEMAMYT15P-A101
M24308/4-452Z	DAMAMYT26P
M24308/4-452F	DAMAMYT26P-A101

Gov't Designation	ITT Part Number
M24308/4-452F	DAMAMYT26P-A101
M24308/4-453Z	DBMAMYT44P
M24308/4-453F	DBMAMYT44P-A101
M24308/4-454Z	DCMAMYT62P
M24308/4-454F	DCMAMYT62P-A101
M24308/4-455Z	DDMAMYT78P
M24308/4-455F	DDMAMYT78P-A101
M24308/4-457Z	DEMAMY9P-FO
M24308/4-457F	DEMAMY9P-A101-FO
M24308/4-458Z	DAMAMY15P-FO
M24308/4-458F	DAMAMY15P-A101-FO
M24308/4-459Z	DBMAMY25P-FO
M24308/4-459F	DBMAMY25P-A101-FO
M24308/4-460Z	DCMAMY37P-FO
M24308/4-460F	DCMAMY37P-A101-FO
M24308/4-461Z	DDMAMY50P-FO
M24308/4-461F	DDMAMY50P-A101-FO
M24308/4-462Z	DEMAMY15P-FO
M24308/4-462F	DEMAMY15P-A101-FO
M24308/4-463Z	DAMAMY26P-FO
M24308/4-463F	DAMAMY26P-A101-FO
M24308/4-464Z	DBMAMY44P-FO
M24308/4-464F	DBMAMY44P-A101-FO
M24308/4-465Z	DCMAMY62P-FO
M24308/4-465F	DCMAMY62P-A101-FO
M24308/4-466Z	DDMAMY78P-FO
M24308/4-466F	DDMAMY78P-A101-FO
M24308/5-1Z	DEMAM9SNM
M24308/5-1F	DEMAM9SNM-A101
M24308/5-1P	DEMAM9SNM-F225
M24308/5-2Z	DAMM15SNM
M24308/5-2F	DAMM15SNM-A101
M24308/5-2P	DAMM15SNM-F225
M24308/5-3Z	DBMM25SNM
M24308/5-3F	DBMM25SNM-A101
M24308/5-3P	DBMM25SNM-F225
M24308/5-4Z	DCMM37SNM
M24308/5-4F	DCMM37SNM-A101
M24308/5-4P	DCMM37SNM-F225
M24308/5-5Z	DDMM50SNM
M24308/5-5F	DDMM50SNM-A101
M24308/5-5P	DDMM50SNM-F225
M24308/5-12Z	DEMMY9SNM
M24308/5-12F	DEMMY9SNM-A101
M24308/5-13Z	DAMMY15SNM
M24308/5-13F	DAMMY15SNM-A101
M24308/5-14Z	DBMMY25SNM
M24308/5-14F	DBMMY25SNM-A101
M24308/5-15Z	DCMMY37SNM
M24308/5-15F	DCMMY37SNM-A101
M24308/5-16Z	DDMMY50SNM
M24308/5-16F	DDMMY50SNM-A101
M24308/5-23Z	DEMMY9SNM
M24308/5-23F	DEMMY9SNM-A101
M24308/5-24Z	DAMMY15SNM
M24308/5-24F	DAMMY15SNM-A101
M24308/5-25Z	DBMMY25SNM
M24308/5-25F	DBMMY25SNM-A101
M24308/5-26Z	DCMMY37SNM

Gov't Designation	ITT Part Number
M24308/5-26F	DCMMY37SNM-A101
M24308/5-27Z	DDMMY50SNM
M24308/5-27F	DDMMY50SNM-A101
M24308/5-34	DEMAM9SNMBK52
M24308/5-35	DAMM15SNMBK52
M24308/5-36	DBMM25SNMBK52
M24308/5-37	DCMM37SNMBK52
M24308/5-38	DDMM50SNMBK52
M24308/5-45	DEMMY9SNMBK52
M24308/5-46	DAMMY15SNMBK52
M24308/5-47	DBMMY25SNMBK52
M24308/5-48	DCMMY37SNMBK52
M24308/5-49	DDMMY50SNMBK52
M24308/5-56	DEMMY9SNMBK52
M24308/5-57	DAMMY15SNMBK52
M24308/5-58	DBMMY25SNMBK52
M24308/5-59	DCMMY37SNMBK52
M24308/5-60	DDMMY50SNMBK52
M24308/6-1Z	DEMAM9SNM
M24308/6-1F	DEMAM9SNM-A101
M24308/6-1P	DEMAM9SNM-F225
M24308/6-2Z	DAMAM15SNM
M24308/6-2F	DAMAM15SNM-A101
M24308/6-2P	DAMAM15SNM-F225
M24308/6-3Z	DBMAM25SNM
M24308/6-3F	DBMAM25SNM-A101
M24308/6-3P	DBMAM25SNM-F225
M24308/6-4Z	DCMAM37SNM
M24308/6-4F	DCMAM37SNM-A101
M24308/6-4P	DCMAM37SNM-F225
M24308/6-5Z	DDMAM50SNM
M24308/6-5F	DDMAM50SNM-A101
M24308/6-5P	DDMAM50SNM-F225
M24308/6-6Z	DEMAMT9SNM
M24308/6-6F	DEMAMT9SNM-A101
M24308/6-6P	DEMAMT9SNM-F225
M24308/6-7Z	DAMAMT15SNM
M24308/6-7F	DAMAMT15SNM-A101
M24308/6-7P	DAMAMT15SNM-F225
M24308/6-8Z	DBMAMT25SNM
M24308/6-8F	DBMAMT25SNM-A101
M24308/6-8P	DBMAMT25SNM-F225
M24308/6-9Z	DCMAMT37SNM
M24308/6-9F	DCMAMT37SNM-A101
M24308/6-9P	DCMAMT37SNM-F225
M24308/6-10Z	DDMAMT50SNM
M24308/6-10F	DDMAMT50SNM-A101
M24308/6-10P	DDMAMT50SNM-F225
M24308/6-11Z	DEMAM15SNM
M24308/6-11F	DEMAM15SNM-A101
M24308/6-11P	DEMAM15SNM-F225
M24308/6-12Z	DAMAM26SNM
M24308/6-12F	DAMAM26SNM-A101
M24308/6-12P	DAMAM26SNM-F225
M24308/6-13Z	DBMAM44SNM
M24308/6-13F	DBMAM44SNM-A101
M24308/6-13P	DBMAM44SNM-F225
M24308/6-14Z	DCMAM62SNM

D Sub



Dimensions shown in inches (mm)
Specifications and dimensions subject to change

www.ittcannon.com

M24308 Cross Reference

Gov't Designation	ITT Part Number
M24308/6-14F	DCMAM62SNM-A101
M24308/6-14P	DCMAM62SNM-F225
M24308/6-15Z	DDMAM78SNM
M24308/6-15F	DDMAM78SNM-A101
M24308/6-15P	DDMAM78SNM-F225
M24308/6-17Z	DEMAMT15SNM
M24308/6-17F	DEMAMT15SNM-A101
M24308/6-17P	DEMAMT15SNM-F225
M24308/6-18Z	DAMAMT26SNM
M24308/6-18F	DAMAMT26SNM-A101
M24308/6-18P	DAMAMT26SNM-F225
M24308/6-19Z	DBMAMT44SNM
M24308/6-19F	DBMAMT44SNM-A101
M24308/6-19P	DBMAMT44SNM-F225
M24308/6-20Z	DCMAMT62SNM
M24308/6-20F	DCMAMT62SNM-A101
M24308/6-20P	DCMAMT62SNM-F225
M24308/6-21Z	DDMAMT78SNM
M24308/6-21F	DDMAMT78SNM-A101
M24308/6-21P	DDMAMT78SNM-F225
M24308/6-259Z	DEMAMY9SNM
M24308/6-259F	DEMAMY9SNM-A101
M24308/6-260Z	DAMAMY15SNM
M24308/6-260F	DAMAMY15SNM-A101
M24308/6-261Z	DBMAMY25SNM
M24308/6-261F	DBMAMY25SNM-A101
M24308/6-262Z	DCMAMY37SNM
M24308/6-262F	DCMAMY37SNM-A101
M24308/6-263Z	DDMAMY50SNM
M24308/6-263F	DDMAMY50SNM-A101
M24308/6-264Z	DEMAMY15SNM
M24308/6-264F	DEMAMY15SNM-A101
M24308/6-265Z	DAMAMY26SNM
M24308/6-265F	DAMAMY26SNM-A101
M24308/6-266Z	DBMAMY44SNM
M24308/6-266F	DCMAMY44SNM-A101
M24308/6-267Z	DCMAMY62SNM
M24308/6-267F	DCMAMY62SNM-A101
M24308/6-268Z	DDMAMY78SNM
M24308/6-268F	DDMAMY78SNM-A101
M24308/6-270Z	DEMAMYT9SNM
M24308/6-270F	DEMAMYT9SNM-A101
M24308/6-271Z	DAMAMYT15SNM
M24308/6-271F	DAMAMYT15SNM-A101
M24308/6-272Z	DBMAMYT25SNM
M24308/6-272F	DBMAMYT25SNM-A101
M24308/6-273Z	DCMAMYT37SNM
M24308/6-273F	DCMAMYT37SNM-A101
M24308/6-274Z	DDMAMY50SNM
M24308/6-274F	DDMAMY50SNM-A101
M24308/6-275Z	DEMAMYT15SNM
M24308/6-275F	DEMAMYT15SNM-A101
M24308/6-276Z	DAMAMYT26SNM
M24308/6-276F	DAMAMYT26SNM-A101
M24308/6-277Z	DBMAMYT44SNM
M24308/6-277F	DCMAMYT44SNM-A101
M24308/6-278Z	DCMAMYT62SNM
M24308/6-278F	DCMAMYT62SNM-A101

Gov't Designation	ITT Part Number
M24308/6-279Z	DDMAMYT78SNM
M24308/6-279F	DDMAMYT78SNM-A101
M24308/6-281Z	DEMAM9SNM-FO
M24308/6-281F	DEMAM9SNM-A101-FO
M24308/6-281P	DEMAM9SNM-F225-FO
M24308/6-282Z	DAMAM15SNM-FO
M24308/6-282F	DAMAM15SNM-A101-FO
M24308/6-282P	DAMAM15SNM-F225-FO
M24308/6-283Z	DBMAM25SNM-FO
M24308/6-283F	DBMAM25SNM-A101-FO
M24308/6-283P	DBMAM25SNM-F225-FO
M24308/6-284Z	DCMAM37SNM-FO
M24308/6-284F	DCMAM37SNM-A101-FO
M24308/6-284P	DCMAM37SNM-F225-FO
M24308/6-285Z	DDMAM50SNM-FO
M24308/6-285F	DDMAM50SNM-A101-FO
M24308/6-285P	DDMAM50SNM-F225-FO
M24308/6-286Z	DEMAM15SNM-FO
M24308/6-286F	DEMAM15SNM-A101-FO
M24308/6-286P	DEMAM15SNM-F225-FO
M24308/6-287Z	DAMAM26SNM-FO
M24308/6-287F	DAMAM26SNM-A101-FO
M24308/6-287P	DAMAM26SNM-F225-FO
M24308/6-288Z	DBMAM44SNM-FO
M24308/6-288F	DBMAM44SNM-A101-FO
M24308/6-288P	DBMAM44SNM-F225-FO
M24308/6-289Z	DCMAM62SNM-FO
M24308/6-289F	DCMAM62SNM-A101-FO
M24308/6-289P	DCMAM62SNM-F225-FO
M24308/6-290Z	DDMAM78SNM-FO
M24308/6-290F	DDMAM78SNM-A101-FO
M24308/6-290P	DDMAM78SNM-F225-FO
M24308/6-324	DEMAMY9SNM-FO
M24308/6-324F	DEMAMY9SNM-A101-FO
M24308/6-325	DAMAMY15SNM-FO
M24308/6-325F	DAMAMY15SNM-A101-FO
M24308/6-326	DBMAMY25SNM-FO
M24308/6-326F	DBMAMY25SNM-A101-FO
M24308/6-327	DCMAMY37SNM-FO
M24308/6-327F	DCMAMY37SNM-A101-FO
M24308/6-328	DDMAMY50SNM-FO
M24308/6-328F	DDMAMY50SNM-A101-FO
M24308/6-453	DEMAMY9SNM
M24308/6-453F	DEMAMY9SNM-A101
M24308/6-454	DAMAMY15SNM
M24308/6-454F	DAMAMY15SNM-A101
M24308/6-455	DBMAMY25SNM
M24308/6-455F	DBMAMY25SNM-A101
M24308/6-456	DCMAMY37SNM
M24308/6-456F	DCMAMY37SNM-A101
M24308/6-457	DDMAMY50SNM
M24308/6-457F	DDMAMY50SNM-A101
M24308/6-458	DEMAMY15SNM
M24308/6-458F	DEMAMY15SNM-A101
M24308/6-459	DAMAMY26SNM
M24308/6-459F	DAMAMY26SNM-A101
M24308/6-460	DBMAMY44SNM
M24308/6-460F	DBMAMY44SNM-A101

Gov't Designation	ITT Part Number
M24308/6-461	DCMAMY62SNM
M24308/6-461F	DCMAMY62SNM-A101
M24308/6-462	DDMAMY78SNM
M24308/6-462F	DDMAMY78SNM-A101
M24308/6-464Z	DEMAMYT9SNM
M24308/6-464F	DEMAMYT9SNM-A101
M24308/6-465Z	DAMAMYT15SNM
M24308/6-465F	DAMAMYT15SNM-A101
M24308/6-466Z	DBMAMYT25SNM
M24308/6-466F	DBMAMYT25SNM-A101
M24308/6-467Z	DCMAMYT37SNM
M24308/6-467F	DCMAMYT37SNM-A101
M24308/6-468Z	DDMAMY50SNM
M24308/6-468F	DDMAMY50SNM-A101
M24308/6-469Z	DEMAMYT15SNM
M24308/6-469F	DEMAMYT15SNM-A101
M24308/6-470Z	DAMAMYT26SNM
M24308/6-470F	DAMAMYT26SNM-A101
M24308/6-471Z	DBMAMYT44SNM
M24308/6-471F	DBMAMYT44SNM-A101
M24308/6-472Z	DCMAMYT62SNM
M24308/6-472F	DCMAMYT62SNM-A101
M24308/6-473Z	DDMAMYT78SNM
M24308/6-473F	DDMAMYT78SNM-A101
M24308/6-491Z	DEMAMY9SNM-FO
M24308/6-491F	DEMAMY9SNM-A101-FO
M24308/6-492Z	DAMAMY15SNM-FO
M24308/6-492F	DAMAMY15SNM-A101-FO
M24308/6-493Z	DBMAMY25SNM-FO
M24308/6-493F	DBMAMY25SNM-A101-FO
M24308/6-494Z	DCMAMY37SNM-FO
M24308/6-494F	DCMAMY37SNM-A101-FO
M24308/6-495Z	DDMAMY50SNM-FO
M24308/6-495F	DDMAMY50SNM-A101-FO
M24308/6-496Z	DEMAMY15SNM-FO
M24308/6-496F	DEMAMY15SNM-A101-FO
M24308/6-497Z	DAMAMY26SNM-FO
M24308/6-497F	DAMAMY26SNM-A101-FO
M24308/6-498Z	DBMAMY44SNM-FO
M24308/6-498F	DBMAMY44SNM-A101-FO
M24308/6-499Z	DCMAMY62SNM-FO
M24308/6-499F	DCMAMY62SNM-A101-FO
M24308/6-500Z	DDMAMY78SNM-FO
M24308/6-500F	DDMAMY78SNM-A101-FO
M24308/6-502	DEMAM9SNMBK52
M24308/6-503	DAMAM15SNMBK52
M24308/6-504	DBMAM25SNMBK52
M24308/6-505	DCMAM37SNMBK52
M24308/6-506	DDMAM50SNMBK52
M24308/6-507	DEMAMT9SNMBK52
M24308/6-508	DAMAMT15SNMBK52
M24308/6-509	DBMAMT25SNMBK52
M24308/6-510	DCMAMT37SNMBK52
M24308/6-511	DDMAMT50SNMBK52
M24308/6-512	DEMAM15SNMBK52
M24308/6-513	DAMAM26SNMBK52
M24308/6-514	DBMAM44SNMBK52
M24308/6-515	DCMAM62SNMBK52



D Sub

Dimensions shown in inches (mm)
Specifications and dimensions subject to change

www.ittcannon.com



M24308 Cross Reference

Gov't Designation	ITT Part Number
M24308/6-516	DDMAM78SNMBK52
M24308/6-518	DEMAMT15SNMBK52
M24308/6-519	DAMAMT26SNMBK52
M24308/6-520	DBMAMT44SNMBK52
M24308/6-521	DCMAMT62SNMBK52
M24308/6-522	DDMAMT78SNMBK52
M24308/6-518	DEMAMY9SNMBK52
M24308/6-519	DAMAMY15SNMBK52
M24308/6-520	DBMAMY25SNMBK52
M24308/6-521	DCMAMY37SNMBK52
M24308/6-522	DDMAMY50SNMBK52
M24308/6-523	DEMAMY15SNMBK52
M24308/6-524	DAMAMY26SNMBK52
M24308/6-525	DBMAMY44SNMBK52
M24308/6-526	DCMAMY62SNMBK52
M24308/6-527	DDMAMY78SNMBK52
M24308/6-528	DEMAMY9SNMBK52
M24308/6-529	DAMAMY15SNMBK52
M24308/6-531	DBMAMY25SNMBK52
M24308/6-532	DCMAMY37SNMBK52
M24308/6-533	DDMAMY50SNMBK52
M24308/6-534	DEMAMY15SNMBK52
M24308/6-535	DAMAMY26SNMBK52
M24308/6-536	DBMAMY44SNMBK52
M24308/6-537	DCMAMY62SNMBK52
M24308/6-538	DDMAMY78SNMBK52
M24308/6-540	DEMAM9SNMBK52-FO
M24308/6-541	DAMAM15SNMBK52-FO
M24308/6-542	DBMAM25SNMBK52-FO
M24308/6-543	DCMAM37SNMBK52-FO
M24308/6-544	DDMAM50SNMBK52-FO
M24308/6-545	DEMAM15SNMBK52-FO
M24308/6-546	DAMAM26SNMBK52-FO
M24308/6-547	DBMAM44SNMBK52-FO
M24308/6-548	DCMAM62SNMBK52-FO
M24308/6-549	DDMAM78SNMBK52-FO
M24308/6-551	DEMAMY9SNMBK52
M24308/6-552	DAMAMY15SNMBK52
M24308/6-553	DBMAMY25SNMBK52
M24308/6-554	DCMAMY37SNMBK52
M24308/6-555	DDMAMY50SNMBK52
M24308/6-556	DEMAMY15SNMBK52
M24308/6-557	DAMAMY26SNMBK52
M24308/6-558	DBMAMY44SNMBK52
M24308/6-559	DCMAMY62SNMBK52
M24308/6-560	DDMAMY78SNMBK52
M24308/6-562	DEMAMYT9SNMBK52
M24308/6-563	DAMAMYT15SNMBK52
M24308/6-564	DBMAMYT25SNMBK52
M24308/6-565	DCMAMYT37SNMBK52
M24308/6-566	DDMAMYT50SNMBK52
M24308/6-567	DEMAMYT15SNMBK52
M24308/6-568	DAMAMYT26SNMBK52
M24308/6-569	DBMAMYT44SNMBK52
M24308/6-570	DCMAMYT62SNMBK52
M24308/6-571	DDMAMYT78SNMBK52
M24308/6-573	DEMAMY9SNMBK52-FO
M24308/6-574	DAMAMY15SNMBK52-FO

Gov't Designation	ITT Part Number
M24308/6-575	DBMAMY25SNMBK52-FO
M24308/6-576	DCMAMY37SNMBK52-FO
M24308/6-577	DDMAMY50SNMBK52-FO
M24308/6-578	DEMAMY15SNMBK52-FO
M24308/6-579	DAMAMY26SNMBK52-FO
M24308/6-580	DBMAMY44SNMBK52-FO
M24308/6-581	DCMAMY62SNMBK52-FO
M24308/6-582	DDMAMY78SNMBK52-FO
M24308/7-1Z	DEMAM9PNM
M24308/7-1F	DEMAM9PNM-A101
M24308/7-1P	DEMAM9PNM-F225
M24308/7-2Z	DAMM15PNM
M24308/7-2F	DAMM15PNM-A101
M24308/7-2P	DAMM15PNM-F225
M24308/7-3Z	DBMM25PNM
M24308/7-3F	DBMM25PNM-A101
M24308/7-3P	DBMM25PNM-F225
M24308/7-4Z	DCMM37PNM
M24308/7-4F	DCMM37PNM-A101
M24308/7-4P	DCMM37PNM-F225
M24308/7-5Z	DDMM50PNM
M24308/7-5F	DDMM50PNM-A101
M24308/7-5P	DDMM50PNM-F225
M24308/7-12Z	DEMMY9PNM
M24308/7-12F	DEMMY9PNM-A101
M24308/7-13Z	DAMMY15PNM
M24308/7-13F	DAMMY15PNM-A101
M24308/7-14Z	DBMMY25PNM
M24308/7-14F	DBMMY25PNM-A101
M24308/7-15Z	DCMMY37PNM
M24308/7-15F	DCMMY37PNM-A101
M24308/7-16Z	DDMMY50PNM
M24308/7-16F	DDMMY50PNM-A101
M24308/7-17Z	DEMMY9PNM
M24308/7-17F	DEMMY9PNM-A101
M24308/7-18Z	DAMMY15PNM
M24308/7-18F	DAMMY15PNM-A101
M24308/7-19Z	DBMMY25PNM
M24308/7-19F	DBMMY25PNM-A101
M24308/7-20Z	DCMMY37PNM
M24308/7-20F	DCMMY37PNM-A101
M24308/7-21Z	DDMMY50PNM
M24308/7-21F	DDMMY50PNM-A101
M24308/7-23	DEMM9PNMBK52
M24308/7-24	DAMM15PNMBK52
M24308/7-25	DBMM25PNMBK52
M24308/7-26	DCMM37PNMBK52
M24308/7-27	DDMM50PNMBK52
M24308/7-34	DEMMY9PNMBK52
M24308/7-35	DAMMY15PNMBK52
M24308/7-36	DBMMY25PNMBK52
M24308/7-37	DCMMY37PNMBK52
M24308/7-38	DDMMY50PNMBK52
M24308/7-39	DEMMY9PNMBK52
M24308/7-40	DAMMY15PNMBK52
M24308/7-41	DBMMY25PNMBK52
M24308/7-42	DCMMY37PNMBK52
M24308/7-43	DDMMY50PNMBK52

Gov't Designation	ITT Part Number
M24308/8-1Z	DEMAM9PNM
M24308/8-1F	DEMAM9PNM-A101
M24308/8-1P	DEMAM9PNM-F225
M24308/8-2Z	DAMAM15PNM
M24308/8-2F	DAMAM15PNM-A101
M24308/8-2P	DAMAM15PNM-F225
M24308/8-3Z	DBMAM25PNM
M24308/8-3F	DBMAM25PNM-A101
M24308/8-3P	DBMAM25PNM-F225
M24308/8-4Z	DCMAM37PNM
M24308/8-4F	DCMAM37PNM-A101
M24308/8-4P	DCMAM37PNM-F225
M24308/8-5Z	DDMAM50PNM
M24308/8-5F	DDMAM50PNM-A101
M24308/8-5P	DDMAM50PNM-F225
M24308/8-6Z	DEMAMT9PNM
M24308/8-6F	DEMAMT9PNM-A101
M24308/8-6P	DEMAMT9PNM-F225
M24308/8-7Z	DEMAMT15PNM
M24308/8-7F	DEMAMT15PNM-A101
M24308/8-7P	DEMAMT15PNM-F225
M24308/8-8Z	DBMAMT25PNM
M24308/8-8F	DBMAMT25PNM-A101
M24308/8-8P	DBMAMT25PNM-F225
M24308/8-9Z	DCMAMT37PNM
M24308/8-9F	DCMAMT37PNM-A101
M24308/8-9P	DCMAMT37PNM-F225
M24308/8-10Z	DDMAMT50PNM
M24308/8-10F	DDMAMT50PNM-A101
M24308/8-10P	DDMAMT50PNM-F225
M24308/8-11Z	DEMAM15PNM
M24308/8-11F	DEMAM15PNM-A101
M24308/8-11P	DEMAM15PNM-F225
M24308/8-12Z	DAMAM26PNM
M24308/8-12F	DAMAM26PNM-A101
M24308/8-12P	DAMAM26PNM-F225
M24308/8-13Z	DBMAM44PNM
M24308/8-13F	DBMAM44PNM-A101
M24308/8-13P	DBMAM44PNM-F225
M24308/8-14Z	DCMAM62PNM
M24308/8-14F	DCMAM62PNM-A101
M24308/8-14P	DCMAM62PNM-F225
M24308/8-15Z	DDMAM78PNM
M24308/8-15F	DDMAM78PNM-A101
M24308/8-15P	DDMAM78PNM-F225
M24308/8-17Z	DEMAMT15PNM
M24308/8-17F	DEMAMT15PNM-A101
M24308/8-17P	DEMAMT15PNM-F225
M24308/8-18Z	DAMAMT26PNM
M24308/8-18F	DAMAMT26PNM-A101
M24308/8-18P	DAMAMT26PNM-F225
M24308/8-19Z	DBMAMT44PNM
M24308/8-19F	DBMAMT44PNM-A101
M24308/8-19P	DBMAMT44PNM-F225
M24308/8-20Z	DCMAMT62PNM
M24308/8-20F	DCMAMT62PNM-A101
M24308/8-20P	DCMAMT62PNM-F225
M24308/8-21Z	DDMAMT78PNM



C

D Sub



Dimensions shown in inches (mm)
Specifications and dimensions subject to change

www.ittcannon.com

M24308 Cross Reference

Gov't Designation	ITT Part Number
M24308/8-21F	DDMAMT78PNM-A101
M24308/8-21P	DDMAMT78PNM-F225
M24308/8-259Z	DEMAM9PNM-FO
M24308/8-259F	DEMAM9PNM-A101-FO
M24308/8-259P	DEMAM9PNM-F225-FO
M24308/8-260Z	DAMAM15PNM-FO
M24308/8-260F	DAMAM15PNM-A101-FO
M24308/8-260P	DAMAM15PNM-F225-FO
M24308/8-261Z	DBMAM25PNM-FO
M24308/8-261F	DBMAM25PNM-A101-FO
M24308/8-261P	DBMAM25PNM-F225-FO
M24308/8-262Z	DCMAM37PNM-FO
M24308/8-262F	DCMAM37PNM-A101-FO
M24308/8-262P	DCMAM37PNM-F225-FO
M24308/8-263Z	DDMAM50PNM-FO
M24308/8-263F	DDMAM50PNM-A101-FO
M24308/8-263P	DDMAM50PNM-F225-FO
M24308/8-264Z	DEMAM15PNM-FO
M24308/8-264F	DEMAM15PNM-A101-FO
M24308/8-264P	DEMAM15PNM-F225-FO
M24308/8-265Z	DAMAM26PNM-FO
M24308/8-265F	DAMAM26PNM-A101-FO
M24308/8-265P	DAMAM26PNM-F225-FO
M24308/8-266Z	DBMAM44PNM-FO
M24308/8-266F	DBMAM44PNM-A101-FO
M24308/8-266P	DBMAM44PNM-F225-FO
M24308/8-267Z	DCMAM62PNM-FO
M24308/8-267F	DCMAM62PNM-A101-FO
M24308/8-267P	DCMAM62PNM-F225-FO
M24308/8-268Z	DDMAM78PNM-FO
M24308/8-268F	DDMAM78PNM-A101-FO
M24308/8-268P	DDMAM78PNM-F225-FO
M24308/8-302Z	DEMAMY9PNM
M24308/8-302F	DEMAMY9PNM-A101
M24308/8-303Z	DAMAMY15PNM
M24308/8-303F	DAMAMY15PNM-A101
M24308/8-304Z	DBMAMY25PNM
M24308/8-304F	DBMAMY25PNM-A101
M24308/8-305Z	DCMAMY37PNM
M24308/8-305F	DCMAMY37PNM-A101
M24308/8-306Z	DDMAMY50PNM
M24308/8-306F	DDMAMY50PNM-A101
M24308/8-307Z	DEMAMY15PNM
M24308/8-307F	DEMAMY15PNM-A101
M24308/8-308Z	DAMAMY26PNM
M24308/8-308F	DAMAMY26PNM-A101
M24308/8-309Z	DBMAMY44PNM
M24308/8-309F	DBMAMY44PNM-A101
M24308/8-310Z	DCMAMY62PNM
M24308/8-310F	DCMAMY62PNM-A101
M24308/8-311Z	DDMAMY78PNM
M24308/8-311F	DDMAMY78PNM-A101
M24308/8-313Z	DEMAMYT9PNM
M24308/8-313F	DEMAMYT9PNM-A101
M24308/8-314Z	DAMAMYT15PNM
M24308/8-314F	DAMAMYT15PNM-A101
M24308/8-315Z	DBMAMYT25PNM
M24308/8-315F	DBMAMYT25PNM-A101
M24308/8-316Z	DCMAMYT37PNM

Gov't Designation	ITT Part Number
M24308/8-316F	DCMAMYT37PNM-A101
M24308/8-317Z	DDMAMY50PNM
M24308/8-317F	DDMAMY50PNM-A101
M24308/8-318Z	DEMAMYT15PNM
M24308/8-318F	DEMAMYT15PNM-A101
M24308/8-319Z	DAMAMYT26PNM
M24308/8-319F	DAMAMYT26PNM-A101
M24308/8-320Z	DBMAMYT44PNM
M24308/8-320F	DBMAMYT44PNM-A101
M24308/8-321Z	DCMAMY62PNM
M24308/8-321F	DCMAMY62PNM-A101
M24308/8-322Z	DDMAMY78PNM
M24308/8-322F	DDMAMY78PNM-A101
M24308/8-324Z	DEMAMY9PNM-FO
M24308/8-324F	DEMAMY9PNM-FO-A101
M24308/8-325Z	DAMAMY15PNM-FO
M24308/8-325F	DAMAMY15PNM-FO-A101
M24308/8-326Z	DBMAMY25PNM-FO
M24308/8-326F	DBMAMY25PNM-FO-A101
M24308/8-327Z	DCMAMY37PNM-FO
M24308/8-327F	DCMAMY37PNM-FO-A101
M24308/8-328Z	DDMAMY50PNM-FO
M24308/8-328F	DDMAMY50PNM-A101-FO
M24308/8-329Z	DEMAMY15PNM-FO
M24308/8-329F	DEMAMY15PNM-A101-FO
M24308/8-330Z	DAMAMY26PNM-FO
M24308/8-331F	DAMAMY26PNM-A101-FO
M24308/8-331Z	DBMAMY44PNM-FO
M24308/8-332F	DBMAMY44PNM-A101-FO
M24308/8-332Z	DCMAMY62PNM-FO
M24308/8-333F	DCMAMY62PNM-A101-FO
M24308/8-333Z	DDMAMY78PNM-FO
M24308/8-333F	DDMAMY78PNM-A101-FO
M24308/8-335	DEMAM9PNMNBK52
M24308/8-336	DAMAM15PNMNBK52
M24308/8-337	DBMAM25PNMNBK52
M24308/8-338	DCMAM37PNMNBK52
M24308/8-339	DDMAM50PNMNBK52
M24308/8-340	DEMAMT9PNMNBK52
M24308/8-341	DEMAMT15PNMNBK52
M24308/8-342	DBMAMT25PNMNBK52
M24308/8-343	DCMAMT37PNMNBK52
M24308/8-344	DDMAMT50PNMNBK52
M24308/8-345	DEMAM15PNMNBK52
M24308/8-346	DAMAM26PNMNBK52
M24308/8-347	DBMAM44PNMNBK52
M24308/8-348	DCMAM62PNMNBK52
M24308/8-349	DDMAM78PNMNBK52
M24308/8-351	DEMAMT15PNMNBK52
M24308/8-352	DAMAMT26PNMNBK52
M24308/8-353	DBMAMT44PNMNBK52
M24308/8-354	DCMAMT62PNMNBK52
M24308/8-355	DDMAMT78PNMNBK52
M24308/8-357	DEMAM9PNMNBK52-FO
M24308/8-358	DAMAM15PNMNBK52-FO
M24308/8-359	DBMAM25PNMNBK52-FO
M24308/8-360	DCMAM37PNMNBK52-FO
M24308/8-361	DDMAM50PNMNBK52-FO

Gov't Designation	ITT Part Number
M24308/8-362	DEMAM15PNMNBK52-FO
M24308/8-363	DAMAM26PNMNBK52-FO
M24308/8-364	DBMAM44PNMNBK52-FO
M24308/8-365	DCMAM62PNMNBK52-FO
M24308/8-366	DDMAM78PNMNBK52-FO
M24308/8-368	DEMAMY9PNMNBK52
M24308/8-369	DAMAMY15PNMNBK52
M24308/8-370	DBMAMY25PNMNBK52
M24308/8-371	DCMAMY37PNMNBK52
M24308/8-372	DDMAMY50PNMNBK52
M24308/8-373	DEMAMY15PNMNBK52
M24308/8-374	DAMAMY26PNMNBK52
M24308/8-375	DBMAMY44PNMNBK52
M24308/8-376	DCMAMY62PNMNBK52
M24308/8-377	DDMAMY78PNMNBK52
M24308/8-379	DEMAMYT9PNMNBK52
M24308/8-380	DAMAMYT15PNMNBK52
M24308/8-381	DBMAMYT25PNMNBK52
M24308/8-382	DCMAMYT37PNMNBK52
M24308/8-383	DDMAMYT50PNMNBK52
M24308/8-384	DEMAMYT15PNMNBK52
M24308/8-385	DAMAMYT26PNMNBK52
M24308/8-386	DBMAMYT44PNMNBK52
M24308/8-387	DCMAMYT62PNMNBK52
M24308/8-388	DDMAMYT78PNMNBK52
M24308/8-390	DEMAMY9PNMNBK52-FO
M24308/8-391	DAMAMY15PNMNBK52-FO
M24308/8-392	DBMAMY25PNMNBK52-FO
M24308/8-393	DCMAMY37PNMNBK52-FO
M24308/8-394	DDMAMY50PNMNBK52-FO
M24308/8-395	DEMAMY15PNMNBK52-FO
M24308/8-396	DAMAMY26PNMNBK52-FO
M24308/8-397	DBMAMY44PNMNBK52-FO
M24308/8-398	DCMAMY62PNMNBK52-FO
M24308/8-399	DDMAMY78PNMNBK52-FO
M24308/8-401	DEMAMY9PNMNBK52
M24308/8-402	DAMAMY15PNMNBK52
M24308/8-403	DBMAMY25PNMNBK52
M24308/8-404	DCMAMY37PNMNBK52
M24308/8-405	DDMAMY50PNMNBK52
M24308/8-406	DEMAMY15PNMNBK52
M24308/8-407	DAMAMY26PNMNBK52
M24308/8-408	DBMAMY44PNMNBK52
M24308/8-409	DCMAMY62PNMNBK52
M24308/8-410	DDMAMY78PNMNBK52
M24308/8-412	DEMAMYT9PNMNBK52
M24308/8-413	DAMAMYT15PNMNBK52
M24308/8-414	DBMAMYT25PNMNBK52
M24308/8-415	DCMAMYT37PNMNBK52
M24308/8-416	DDMAMYT50PNMNBK52
M24308/8-417	DEMAMYT15PNMNBK52
M24308/8-418	DAMAMYT26PNMNBK52
M24308/8-419	DBMAMYT44PNMNBK52
M24308/8-420	DCMAMYT62PNMNBK52
M24308/8-421	DDMAMYT78PNMNBK52
M24308/8-423	DEMAMY9PNMNBK52-FO
M24308/8-424	DAMAMY15PNMNBK52-FO
M24308/8-425	DBMAMY25PNMNBK52-FO



D Sub

Dimensions shown in inches (mm)
 Specifications and dimensions subject to change

www.ittcannon.com



M24308 Cross Reference

Gov't Designation	ITT Part Number
M24308/8-427	DDMAMY50PNMBK52-FO
M24308/8-428	DEMAMY15PNMBK52-FO
M24308/8-429	DAMAMY26PNMBK52-FO
M24308/8-430	DBMAMY44PNMBK52-FO
M24308/8-431	DCMAMY62PNMBK52-FO
M24308/8-432	DDMAMY78PNMBK52-FO
M24308/8-435Z	DEMAMY9PNM
M24308/8-435F	DEMAMY9PNM-A101
M24308/8-436Z	DAMAMY15PNM
M24308/8-436F	DAMAMY15PNM-A101
M24308/8-437Z	DBMAMY25PNM
M24308/8-437F	DBMAMY25PNM-A101
M24308/8-438Z	DCMAMY37PNM
M24308/8-438F	DCMAMY37PNM-A101
M24308/8-439Z	DDMAMY50PNM
M24308/8-439F	DDMAMY50PNM-A101
M24308/8-440Z	DEMAMY15PNM
M24308/8-440F	DEMAMY15PNM-A101
M24308/8-441Z	DAMAMY26PNM
M24308/8-441F	DAMAMY26PNM-A101
M24308/8-442Z	DBMAMY44PNM
M24308/8-442F	DBMAMY44PNM-A101
M24308/8-443Z	DCMAMY62PNM
M24308/8-443F	DCMAMY62PNM-A101
M24308/8-444Z	DDMAMY78PNM
M24308/8-444F	DDMAMY78PNM-A101
M24308/8-446Z	DEMAMYT9PNM
M24308/8-446F	DEMAMYT9PNM-A101
M24308/8-447Z	DAMAMYT15PNM
M24308/8-447F	DAMAMYT15PNM-A101
M24308/8-448Z	DBMAMYT25PNM
M24308/8-448F	DBMAMYT25PNM-A101
M24308/8-449Z	DCMAMYT37PNM
M24308/8-449F	DCMAMYT37PNM-A101
M24308/8-450Z	DDMAMYT50PNM
M24308/8-450F	DDMAMYT50PNM-A101
M24308/8-451Z	DEMAMYT15PNM
M24308/8-451F	DEMAMYT15PNM-A101
M24308/8-452Z	DAMAMYT26PNM
M24308/8-452F	DAMAMYT26PNM-A101
M24308/8-453Z	DBMAMYT44PNM
M24308/8-453F	DBMAMYT44PNM-A101
M24308/8-454Z	DCMAMYT62PNM
M24308/8-454F	DCMAMYT62PNM-A101
M24308/8-455Z	DDMAMYT78PNM
M24308/8-455F	DDMAMYT78PNM-A101
M24308/8-457Z	DEMAMY9PNM-FO
M24308/8-457F	DEMAMY9PNM-A101-FO
M24308/8-458Z	DAMAMY15PNM-FO
M24308/8-458F	DAMAMY15PNM-A101-FO
M24308/8-459Z	DBMAMY25PNM-FO
M24308/8-459F	DBMAMY25PNM-A101-FO
M24308/8-460Z	DCMAMY37PNM-FO
M24308/8-460F	DCMAMY37PNM-A101-FO
M24308/8-461Z	DDMAMY50PNM-FO
M24308/8-461F	DDMAMY50PNM-A101-FO
M24308/8-462Z	DEMAMY15PNM-FO
M24308/8-462F	DEMAMY15PNM-A101-FO
M24308/8-463Z	DAMAMY26PNM-FO

Gov't Designation	ITT Part Number
M24308/8-463F	DAMAMY26PNM-A101-FO
M24308/8-464Z	DBMAMY44PNM-FO
M24308/8-464F	DBMAMY44PNM-A101-FO
M24308/8-465Z	DCMAMY62PNM-FO
M24308/8-465F	DCMAMY62PNM-A101-FO
M24308/8-466Z	DDMAMY78PNM-FO
M24308/8-466F	DDMAMY78PNM-A101-FO
M24308/9-1	DEH9P002
M24308/9-2	DAH15P002
M24308/9-3	DBH25P002
M24308/9-4	DCH37P002
M24308/9-5	DDH50P002
M24308/9-6	DEH9P001
M24308/9-7	DAH15P001
M24308/9-8	DBH25P001
M24308/9-9	DCH37P001
M24308/9-10	DDH50P001
M24308/9-11	DEH9P202
M24308/9-12	DAH15P202
M24308/9-13	DBH25P202
M24308/9-14	DCH37P202
M24308/9-15	DDH50P202
M24308/9-16	DEH9P201
M24308/9-17	DAH15P201
M24308/9-18	DBH25P201
M24308/9-19	DCH37P201
M24308/9-20	DDH50P201
M24308/23-1Z	DEMMS9SM
M24308/23-1F	DEMMS9SM-A101
M24308/23-1P	DEMMS9SM-F225
M24308/23-2Z	DAMM15SM
M24308/23-2F	DAMM15SM-A101
M24308/23-2P	DAMM15SM-F225
M24308/23-3Z	DBMM25SM
M24308/23-3F	DBMM25SM-A101
M24308/23-3P	DBMM25SM-F225
M24308/23-4Z	DCMM37SM
M24308/23-4F	DCMM37SM-A101
M24308/23-4P	DCMM37SM-F225
M24308/23-5Z	DDMM50SM
M24308/23-5F	DDMM50SM-A101
M24308/23-5P	DDMM50SM-F225
M24308/23-7Z	DEMMS9SZ
M24308/23-7F	DEMMS9SZ-A101
M24308/23-7P	DEMMS9SZ-F225
M24308/23-8Z	DAMM15SZ
M24308/23-8F	DAMM15SZ-A101
M24308/23-8P	DAMM15SZ-F225
M24308/23-9Z	DBMM25SZ
M24308/23-9F	DBMM25SZ-A101
M24308/23-9P	DBMM25SZ-F225
M24308/23-10Z	DCMM37SZ
M24308/23-10F	DCMM37SZ-A101
M24308/23-10P	DCMM37SZ-F225
M24308/23-11Z	DDMM50SZ
M24308/23-11F	DDMM50SZ-A101
M24308/23-11P	DDMM50SZ-F225
M24308/23-13Z	DEMMS9SH
M24308/23-13F	DEMMS9SH-A101

Gov't Designation	ITT Part Number
M24308/23-13P	DEMMS9SH-F225
M24308/23-14Z	DAMM15SH
M24308/23-14F	DAMM15SH-A101
M24308/23-14P	DAMM15SH-F225
M24308/23-15Z	DBMM25SH
M24308/23-15F	DBMM25SH-A101
M24308/23-15P	DBMM25SH-F225
M24308/23-16Z	DCMM37SH
M24308/23-16F	DCMM37SH-A101
M24308/23-16P	DCMM37SH-F225
M24308/23-17Z	DDMM50SH
M24308/23-17F	DDMM50SH-A101
M24308/23-17P	DDMM50SH-F225
M24308/23-19Z	DEMMS9SX
M24308/23-19F	DEMMS9SX-A101
M24308/23-19P	DEMMS9SX-F225
M24308/23-20Z	DAMM15SX
M24308/23-20F	DAMM15SX-A101
M24308/23-20P	DAMM15SX-F225
M24308/23-21Z	DBMM25SX
M24308/23-21F	DBMM25SX-A101
M24308/23-21P	DBMM25SX-F225
M24308/23-22Z	DCMM37SX
M24308/23-22F	DCMM37SX-A101
M24308/23-22P	DCMM37SX-F225
M24308/23-23Z	DDMM50SX
M24308/23-23F	DDMM50SX-A101
M24308/23-23P	DDMM50SX-F225
M24308/23-25Z	DEMMS9SD
M24308/23-25F	DEMMS9SD-A101
M24308/23-26Z	DAMM15SD
M24308/23-26F	DAMM15SD-A101
M24308/23-27Z	DBMM25SD
M24308/23-27F	DBMM25SD-A101
M24308/23-28Z	DCMM37SD
M24308/23-28F	DCMM37SD-A101
M24308/23-29Z	DDMM50SD
M24308/23-29F	DDMM50SD-A101
M24308/23-31Z	DEMMS9SL
M24308/23-31F	DEMMS9SL-A101
M24308/23-32Z	DAMM15SL
M24308/23-32F	DAMM15SL-A101
M24308/23-33Z	DBMM25SL
M24308/23-33F	DBMM25SL-A101
M24308/23-34Z	DCMM37SL
M24308/23-34F	DCMM37SL-A101
M24308/23-35Z	DDMM50SL
M24308/23-35F	DDMM50SL-A101
M24308/23-37Z	DEMMS9SA
M24308/23-37F	DEMMS9SA-A101
M24308/23-38Z	DAMM15SA
M24308/23-38F	DAMM15SA-A101
M24308/23-39Z	DBMM25SA
M24308/23-39F	DBMM25SA-A101
M24308/23-40Z	DCMM37SA
M24308/23-40F	DCMM37SA-A101
M24308/23-41Z	DDMM50SA
M24308/23-41F	DDMM50SA-A101
M24308/23-43Z	DEMMS9SG

D Sub



Dimensions shown in inches (mm)
Specifications and dimensions subject to change

www.ittcannon.com

M24308 Cross Reference

Gov't Designation	ITT Part Number
M24308/23-43F	DEMM9SG-A101
M24308/23-44Z	DAMM15SG
M24308/23-44F	DAMM15SG-A101
M24308/23-45Z	DBMM25SG
M24308/23-45F	DBMM25SG-A101
M24308/23-46Z	DCMM37SG
M24308/23-46F	DCMM37SG-A101
M24308/23-47Z	DDMM50SG
M24308/23-47F	DDMM50SG-A101
M24308/23-49Z	DEMM9SS
M24308/23-49F	DEMM9SS-A101
M24308/23-50Z	DAMM15SS
M24308/23-50F	DAMM15SS-A101
M24308/23-51Z	DBMM25SS
M24308/23-51F	DBMM25SS-A101
M24308/23-52Z	DCMM37SS
M24308/23-52F	DCMM37SS-A101
M24308/23-53Z	DDMM50SS
M24308/23-53F	DDMM50SS-A101
M24308/23-55Z	DEMM9SW
M24308/23-55F	DEMM9SW-A101
M24308/23-56Z	DAMM15SW
M24308/23-56F	DAMM15SW-A101
M24308/23-57Z	DBMM25SW
M24308/23-57F	DBMM25SW-A101
M24308/23-58Z	DCMM37SW
M24308/23-58F	DCMM37SW-A101
M24308/23-59Z	DDMM50SW
M24308/23-59F	DDMM50SW-A101
M24308/23-61Z	DEMAM15SM
M24308/23-61F	DEMAM15SM-A101
M24308/23-61P	DEMAM15SM-F225
M24308/23-62Z	DAMAM25SM
M24308/23-62F	DAMAM25SM-A101
M24308/23-62P	DAMAM25SM-F225
M24308/23-63Z	DBMAM44SM
M24308/23-63F	DBMAM44SM-A101
M24308/23-63P	DBMAM44SM-F225
M24308/23-64Z	DCMAM62SM
M24308/23-64F	DCMAM62SM-A101
M24308/23-64P	DCMAM62SM-F225
M24308/23-65Z	DDMAM78SM
M24308/23-65F	DDMAM78SM-A101
M24308/23-65P	DDMAM78SM-F225
M24308/23-67Z	DEMAM15SQ
M24308/23-67F	DEMAM15SQ-A101
M24308/23-67P	DEMAM15SQ-F225
M24308/23-68Z	DAMAM25SQ
M24308/23-68F	DAMAM25SQ-A101
M24308/23-68P	DAMAM25SQ-F225
M24308/23-69Z	DBMAM44SQ
M24308/23-69F	DBMAM44SQ-A101
M24308/23-69P	DBMAM44SQ-F225
M24308/23-70Z	DCMAM62SQ
M24308/23-70F	DCMAM62SQ-A101
M24308/23-70P	DCMAM62SQ-F225
M24308/23-71Z	DDMAM78SQ
M24308/23-71F	DDMAM78SQ-A101
M24308/23-71P	DDMAM78SQ-F225

Gov't Designation	ITT Part Number
M24308/23-73Z	DEMAM15SA
M24308/23-73F	DEMAM15SA-A101
M24308/23-74Z	DAMAM25SA
M24308/23-74F	DAMAM25SA-A101
M24308/23-75Z	DBMAM44SA
M24308/23-75F	DBMAM44SA-A101
M24308/23-76Z	DCMAM62SA
M24308/23-76F	DCMAM62SA-A101
M24308/23-77Z	DDMAM78SA
M24308/23-77F	DDMAM78SA-A101
M24308/23-101	DEMM9SMNMBK52
M24308/23-102	DAMM15SMNMBK52
M24308/23-103	DBMM25SMNMBK52
M24308/23-104	DCMM37SMNMBK52
M24308/23-105	DDMM50SMNMBK52
M24308/23-107	DEMM9SZNMBK52
M24308/23-108	DAMM15SZNMBK52
M24308/23-109	DBMM25SZNMBK52
M24308/23-110	DCMM37SZNMBK52
M24308/23-111	DDMM50SZNMBK52
M24308/23-113	DEMM9SHNMBK52
M24308/23-114	DAMM15SHNMBK52
M24308/23-115	DBMM25SHNMBK52
M24308/23-116	DCMM37SHNMBK52
M24308/23-117	DDMM50SHNMBK52
M24308/23-119	DEMM9SXNMBK52
M24308/23-120	DAMM15SXNMBK52
M24308/23-121	DBMM25SXNMBK52
M24308/23-122	DCMM37SXNMBK52
M24308/23-123	DDMM50SXNMBK52
M24308/23-125	DEMM9SDNMBK52
M24308/23-126	DAMM15SDNMBK52
M24308/23-127	DBMM25SDNMBK52
M24308/23-128	DCMM37SDNMBK52
M24308/23-129	DDMM50SDNMBK52
M24308/23-131	DEMM9SLNMBK52
M24308/23-132	DAMM15SLNMBK52
M24308/23-133	DBMM25SLNMBK52
M24308/23-134	DCMM37SLNMBK52
M24308/23-135	DDMM50SLNMBK52
M24308/23-137	DEMM9SANMBK52
M24308/23-138	DAMM15SANMBK52
M24308/23-139	DBMM25SANMBK52
M24308/23-140	DCMM37SANMBK52
M24308/23-141	DDMM50SANMBK52
M24308/23-143	DEMM9SGNMBK52
M24308/23-144	DAMM15SGNMBK52
M24308/23-145	DBMM25SGNMBK52
M24308/23-146	DCMM37SGNMBK52
M24308/23-147	DDMM50SGNMBK52
M24308/23-149	DEMM9SSNMBK52
M24308/23-150	DAMM15SSNMBK52
M24308/23-151	DBMM25SSNMBK52
M24308/23-152	DCMM37SSNMBK52
M24308/23-153	DDMM50SSNMBK52
M24308/23-155	DEMM9SWNMBK52
M24308/23-156	DAMM15SWNMBK52
M24308/23-157	DBMM25SWNMBK52
M24308/23-158	DCMM37SWNMBK52

Gov't Designation	ITT Part Number
M24308/23-159	DDMM50SWNMBK52
M24308/23-161Z	DEMAM15SMNMBK52
M24308/23-162Z	DAMAM25SMNMBK52
M24308/23-163Z	DBMAM44SMNMBK52
M24308/23-164Z	DCMAM62SMNMBK52
M24308/23-165Z	DDMAM78SMNMBK52
M24308/23-167Z	DEMAM15SQNMBK52
M24308/23-168Z	DAMAM25SQNMBK52
M24308/23-169Z	DBMAM44SQNMBK52
M24308/23-170Z	DCMAM62SQNMBK52
M24308/23-171Z	DDMAM78SQNMBK52
M24308/23-173Z	DEMAM15SANMBK52
M24308/23-174Z	DAMAM25SANMBK52
M24308/23-175Z	DBMAM44SANMBK52
M24308/23-176Z	DCMAM62SANMBK52
M24308/23-177Z	DDMAM78SANMBK52
M24308/23-201Z	DEMM9SMNM
M24308/23-201F	DEMM9SMNM-A101
M24308/23-201P	DEMM9SMNM-F225
M24308/23-202Z	DAMM15SMNM
M24308/23-202F	DAMM15SMNM-A101
M24308/23-202P	DAMM15SMNM-F225
M24308/23-203Z	DBMM25SMNM
M24308/23-203F	DBMM25SMNM-A101
M24308/23-203P	DBMM25SMNM-F225
M24308/23-204Z	DCMM37SMNM
M24308/23-204F	DCMM37SMNM-A101
M24308/23-204P	DCMM37SMNM-F225
M24308/23-205Z	DDMM50SMNM
M24308/23-205F	DDMM50SMNM-A101
M24308/23-205P	DDMM50SMNM-F225
M24308/23-207Z	DEMM9SZNM
M24308/23-207F	DEMM9SZNM-A101
M24308/23-207P	DEMM9SZNM-F225
M24308/23-208Z	DAMM15SZNM
M24308/23-208F	DAMM15SZNM-A101
M24308/23-208P	DAMM15SZNM-F225
M24308/23-209Z	DBMM25SZNM
M24308/23-209F	DBMM25SZNM-A101
M24308/23-209P	DBMM25SZNM-F225
M24308/23-210Z	DCMM37SZNM
M24308/23-210F	DCMM37SZNM-A101
M24308/23-210P	DCMM37SZNM-F225
M24308/23-211Z	DDMM50SZNM
M24308/23-211F	DDMM50SZNM-A101
M24308/23-211P	DDMM50SZNM-F225
M24308/23-213Z	DEMM9SHNM
M24308/23-213F	DEMM9SHNM-A101
M24308/23-213P	DEMM9SHNM-F225
M24308/23-214Z	DAMM15SHNM
M24308/23-214F	DAMM15SHNM-A101
M24308/23-214P	DAMM15SHNM-F225
M24308/23-215Z	DBMM25SHNM
M24308/23-215F	DBMM25SHNM-A101
M24308/23-215P	DBMM25SHNM-F225
M24308/23-216Z	DCMM37SHNM
M24308/23-216F	DCMM37SHNM-A101
M24308/23-216P	DCMM37SHNM-F225
M24308/23-217Z	DDMM50SHNM

Dimensions shown in inches (mm)
 Specifications and dimensions subject to change

www.ittcannon.com



M24308 Cross Reference

Gov't Designation	ITT Part Number
M24308/23-217F	DDMM50SHNM-A101
M24308/23-217P	DDMM50SHNM-F225
M24308/23-219Z	DEMM9SXNM
M24308/23-219F	DEMM9SXNM-A101
M24308/23-219P	DEMM9SXNM-F225
M24308/23-220Z	DAMM15SXNM
M24308/23-220F	DAMM15SXNM-A101
M24308/23-220P	DAMM15SXNM-F225
M24308/23-221Z	DBMM25SXNM
M24308/23-221F	DBMM25SXNM-A101
M24308/23-221P	DBMM25SXNM-F225
M24308/23-222Z	DCMM37SXNM
M24308/23-222F	DCMM37SXNM-A101
M24308/23-222P	DCMM37SXNM-F225
M24308/23-223Z	DDMM50SXNM
M24308/23-223F	DDMM50SXNM-A101
M24308/23-223P	DDMM50SXNM-F225
M24308/23-225Z	DEMM9SDNM
M24308/23-225F	DEMM9SDNM-A101
M24308/23-226Z	DAMM15SDNM
M24308/23-226F	DAMM15SDNM-A101
M24308/23-227Z	DBMM25SDNM
M24308/23-227F	DBMM25SDNM-A101
M24308/23-228Z	DCMM37SDNM
M24308/23-228F	DCMM37SDNM-A101
M24308/23-229Z	DDMM50SDNM
M24308/23-229F	DDMM50SDNM-A101
M24308/23-231Z	DEMM9SLNM
M24308/23-231F	DEMM9SLNM-A101
M24308/23-232Z	DAMM15SLNM
M24308/23-232F	DAMM15SLNM-A101
M24308/23-233Z	DBMM25SLNM
M24308/23-233F	DBMM25SLNM-A101
M24308/23-234Z	DCMM37SLNM
M24308/23-234F	DCMM37SLNM-A101
M24308/23-235Z	DDMM50SLNM
M24308/23-235F	DDMM50SLNM-A101
M24308/23-237Z	DEMM9SANM
M24308/23-237F	DEMM9SANM-A101
M24308/23-238Z	DAMM15SANM
M24308/23-238F	DAMM15SANM-A101
M24308/23-239Z	DBMM25SANM
M24308/23-239F	DBMM25SANM-A101
M24308/23-240Z	DCMM37SANM
M24308/23-240F	DCMM37SANM-A101
M24308/23-241Z	DDMM50SANM
M24308/23-241F	DDMM50SANM-A101
M24308/23-243Z	DEMM9SGNM
M24308/23-243F	DEMM9SGNM-A101
M24308/23-244Z	DAMM15SGNM
M24308/23-244F	DAMM15SGNM-A101
M24308/23-245Z	DBMM25SGNM
M24308/23-245F	DBMM25SGNM-A101
M24308/23-246Z	DCMM37SGNM
M24308/23-246F	DCMM37SGNM-A101
M24308/23-247Z	DDMM50SGNM
M24308/23-247F	DDMM50SGNM-A101
M24308/23-249Z	DEMM9SSNM
M24308/23-249F	DEMM9SSNM-A101

Gov't Designation	ITT Part Number
M24308/23-250Z	DAMM15SSNM
M24308/23-250F	DAMM15SSNM-A101
M24308/23-251Z	DBMM25SSNM
M24308/23-251F	DBMM25SSNM-A101
M24308/23-252Z	DCMM37SSNM
M24308/23-252F	DCMM37SSNM-A101
M24308/23-253Z	DDMM50SSNM
M24308/23-253F	DDMM50SSNM-A101
M24308/23-255Z	DEMM9SWNM
M24308/23-255F	DEMM9SWNM-A101
M24308/23-256Z	DAMM15SWNM
M24308/23-256F	DAMM15SWNM-A101
M24308/23-257Z	DBMM25SWNM
M24308/23-257F	DBMM25SWNM-A101
M24308/23-258Z	DCMM37SWNM
M24308/23-258F	DCMM37SWNM-A101
M24308/23-259Z	DDMM50SWNM
M24308/23-259F	DDMM50SWNM-A101
M24308/23-261Z	DEMAM15SMNM
M24308/23-261F	DEMAM15SMNM-A101
M24308/23-261P	DEMAM15SMNM-F225
M24308/23-262Z	DAMAM25SMNM
M24308/23-262F	DAMAM25SMNM-A101
M24308/23-262P	DAMAM25SMNM-F225
M24308/23-263Z	DBMAM44SMNM
M24308/23-263F	DBMAM44SMNM-A101
M24308/23-263P	DBMAM44SMNM-F225
M24308/23-264Z	DCMAM62SMNM
M24308/23-264F	DCMAM62SMNM-A101
M24308/23-264P	DCMAM62SMNM-F225
M24308/23-265Z	DDMAM78SMNM
M24308/23-265F	DDMAM78SMNM-A101
M24308/23-265P	DDMAM78SMNM-F225
M24308/23-267Z	DEMAM15SQNM
M24308/23-267F	DEMAM15SQNM-A101
M24308/23-267P	DEMAM15SQNM-F225
M24308/23-268Z	DAMAM25SQNM
M24308/23-268F	DAMAM25SQNM-A101
M24308/23-268P	DAMAM25SQNM-F225
M24308/23-269Z	DBMAM44SQNM
M24308/23-269F	DBMAM44SQNM-A101
M24308/23-269P	DBMAM44SQNM-F225
M24308/23-270Z	DCMAM62SQNM
M24308/23-270F	DCMAM62SQNM-A101
M24308/23-270P	DCMAM62SQNM-F225
M24308/23-271Z	DDMAM78SQNM
M24308/23-271F	DDMAM78SQNM-A101
M24308/23-271P	DDMAM78SQNM-F225
M24308/23-273Z	DEMAM15SANM
M24308/23-273F	DEMAM15SANM-A101
M24308/23-274Z	DAMAM25SANM
M24308/23-274F	DAMAM25SANM-A101
M24308/23-275Z	DBMAM44SANM
M24308/23-275F	DBMAM44SANM-A101
M24308/23-276Z	DCMAM62SANM
M24308/23-276F	DCMAM62SANM-A101
M24308/23-277Z	DDMAM78SANM
M24308/23-277F	DDMAM78SANM-A101
M24308/24-1Z	DEMM9PM

Gov't Designation	ITT Part Number
M24308/24-1F	DEMM9PM-A101
M24308/24-1P	DEMM9PM-F225
M24308/24-2Z	DAMM15PM
M24308/24-2F	DAMM15PM-A101
M24308/24-2P	DAMM15PM-F225
M24308/24-3Z	DBMM25PM
M24308/24-3F	DBMM25PM-A101
M24308/24-3P	DBMM25PM-F225
M24308/24-4Z	DCMM37PM
M24308/24-4F	DCMM37PM-A101
M24308/24-4P	DCMM37PM-F225
M24308/24-5Z	DDMM50PM
M24308/24-5F	DDMM50PM-A101
M24308/24-5P	DDMM50PM-F225
M24308/24-7Z	DEMM9PZ
M24308/24-7F	DEMM9PZ-A101
M24308/24-7P	DEMM9PZ-F225
M24308/24-8Z	DAMM15PZ
M24308/24-8F	DAMM15PZ-A101
M24308/24-8P	DAMM15PZ-F225
M24308/24-9Z	DBMM25PZ
M24308/24-9F	DBMM25PZ-A101
M24308/24-9P	DBMM25PZ-F225
M24308/24-10Z	DCMM37PZ
M24308/24-10F	DCMM37PZ-A101
M24308/24-10P	DCMM37PZ-F225
M24308/24-11Z	DDMM50PZ
M24308/24-11F	DDMM50PZ-A101
M24308/24-11P	DDMM50PZ-F225
M24308/24-13Z	DEMM9PH
M24308/24-13F	DEMM9PH-A101
M24308/24-13P	DEMM9PH-F225
M24308/24-14Z	DAMM15PH
M24308/24-14F	DAMM15PH-A101
M24308/24-14P	DAMM15PH-F225
M24308/24-15Z	DBMM25PH
M24308/24-15F	DBMM25PH-A101
M24308/24-15P	DBMM25PH-F225
M24308/24-16Z	DCMM37PH
M24308/24-16F	DCMM37PH-A101
M24308/24-16P	DCMM37PH-F225
M24308/24-17Z	DDMM50PH
M24308/24-17F	DDMM50PH-A101
M24308/24-17P	DDMM50PH-F225
M24308/24-19Z	DEMM9PX
M24308/24-19F	DEMM9PX-A101
M24308/24-19P	DEMM9PX-F225
M24308/24-20Z	DAMM15PX
M24308/24-20F	DAMM15PX-A101
M24308/24-20P	DAMM15PX-F225
M24308/24-21Z	DBMM25PX
M24308/24-21F	DBMM25PX-A101
M24308/24-21P	DBMM25PX-F225
M24308/24-22Z	DCMM37PX
M24308/24-22F	DCMM37PX-A101
M24308/24-22P	DCMM37PX-F225
M24308/24-23Z	DDMM50PX
M24308/24-23F	DDMM50PX-A101
M24308/24-23P	DDMM50PX-F225



C

D Sub



Dimensions shown in inches (mm)
Specifications and dimensions subject to change

www.ittcannon.com

M24308 Cross Reference

Gov't Designation	ITT Part Number
M24308/24-25Z	DEM99PD
M24308/24-25F	DEM99PD-A101
M24308/24-26Z	DAM15PD
M24308/24-26F	DAM15PD-A101
M24308/24-27Z	DBM25PD
M24308/24-27F	DBM25PD-A101
M24308/24-28Z	DCM37PD
M24308/24-28F	DCM37PD-A101
M24308/24-29Z	DDM50PD
M24308/24-29F	DDM50PD-A101
M24308/24-31Z	DEM99PL
M24308/24-31F	DEM99PL-A101
M24308/24-32Z	DAM15PL
M24308/24-32F	DAM15PL-A101
M24308/24-33Z	DBM25PL
M24308/24-33F	DBM25PL-A101
M24308/24-34Z	DCM37PL
M24308/24-34F	DCM37PL-A101
M24308/24-35Z	DDM50PL
M24308/24-35F	DDM50PL-A101
M24308/24-37Z	DEM99PA
M24308/24-37F	DEM99PA-A101
M24308/24-38Z	DAM15PA
M24308/24-38F	DAM15PA-A101
M24308/24-39Z	DBM25PA
M24308/24-39F	DBM25PA-A101
M24308/24-40Z	DCM37PA
M24308/24-40F	DCM37PA-A101
M24308/24-41Z	DDM50PA
M24308/24-41F	DDM50PA-A101
M24308/24-43Z	DEM99PG
M24308/24-43F	DEM99PG-A101
M24308/24-44Z	DAM15PG
M24308/24-44F	DAM15PG-A101
M24308/24-45Z	DBM25PG
M24308/24-45F	DBM25PG-A101
M24308/24-46Z	DCM37PG
M24308/24-46F	DCM37PG-A101
M24308/24-47Z	DDM50PG
M24308/24-47F	DDM50PG-A101
M24308/24-49Z	DEM99PS
M24308/24-49F	DEM99PS-A101
M24308/24-50Z	DAM15PS
M24308/24-50F	DAM15PS-A101
M24308/24-51Z	DBM25PS
M24308/24-51F	DBM25PS-A101
M24308/24-52Z	DCM37PS
M24308/24-52F	DCM37PS-A101
M24308/24-53Z	DDM50PS
M24308/24-53F	DDM50PS-A101
M24308/24-55Z	DEM99PW
M24308/24-55F	DEM99PW-A101
M24308/24-56Z	DAM15PW
M24308/24-56F	DAM15PW-A101
M24308/24-57Z	DBM25PW
M24308/24-57F	DBM25PW-A101
M24308/24-58Z	DCM37PW
M24308/24-58F	DCM37PW-A101
M24308/24-59Z	DDM50PW

Gov't Designation	ITT Part Number
M24308/24-59F	DDM50PW-A101
M24308/24-61Z	DEMAM15PM
M24308/24-61F	DEMAM15PM-A101
M24308/24-61P	DEMAM15PM-F225
M24308/24-62Z	DAMAM25PM
M24308/24-62F	DAMAM25PM-A101
M24308/24-62P	DAMAM25PM-F225
M24308/24-63Z	DBMAM44PM
M24308/24-63F	DBMAM44PM-A101
M24308/24-63P	DBMAM44PM-F225
M24308/24-64Z	DCMAM62PM
M24308/24-64F	DCMAM62PM-A101
M24308/24-64P	DCMAM62PM-F225
M24308/24-65Z	DDMAM78PM
M24308/24-65F	DDMAM78PM-A101
M24308/24-65P	DDMAM78PM-F225
M24308/24-67Z	DEMAM15PQ
M24308/24-67F	DEMAM15PQ-A101
M24308/24-67P	DEMAM15PQ-F225
M24308/24-68Z	DAMAM25PQ
M24308/24-68F	DAMAM25PQ-A101
M24308/24-68P	DAMAM25PQ-F225
M24308/24-69Z	DBMAM44PQ
M24308/24-69F	DBMAM44PQ-A101
M24308/24-69P	DBMAM44PQ-F225
M24308/24-70Z	DCMAM62PQ
M24308/24-70F	DCMAM62PQ-A101
M24308/24-70P	DCMAM62PQ-F225
M24308/24-71Z	DDMAM78PQ
M24308/24-71F	DDMAM78PQ-A101
M24308/24-71P	DDMAM78PQ-F225
M24308/24-73Z	DEMAM15PA
M24308/24-73F	DEMAM15PA-A101
M24308/24-73P	DEMAM15PA-F225
M24308/24-74Z	DAMAM25PA
M24308/24-74F	DAMAM25PA-A101
M24308/24-74P	DAMAM25PA-F225
M24308/24-75Z	DBMAM44PA
M24308/24-75F	DBMAM44PA-A101
M24308/24-75P	DBMAM44PA-F225
M24308/24-76Z	DCMAM62PA
M24308/24-76F	DCMAM62PA-A101
M24308/24-76P	DCMAM62PA-F225
M24308/24-77Z	DDMAM78PA
M24308/24-77F	DDMAM78PA-A101
M24308/24-77P	DDMAM78PA-F225
M24308/24-101	DEM99PMNMBK52
M24308/24-102	DAM15PMNMBK52
M24308/24-103	DBM25PMNMBK52
M24308/24-104	DCM37PMNMBK52
M24308/24-105	DDM50PMNMBK52
M24308/24-107	DEM99PNMBK52
M24308/24-108	DAM15PNMBK52
M24308/24-109	DBM25PNMBK52
M24308/24-110	DCM37PNMBK52
M24308/24-111	DDM50PNMBK52
M24308/24-113	DEM99PHNMBK52
M24308/24-114	DAM15PHNMBK52
M24308/24-115	DBM25PHNMBK52

Gov't Designation	ITT Part Number
M24308/24-115	DBM25PHNMBK52
M24308/24-116	DCM37PHNMBK52
M24308/24-117	DDM50PHNMBK52
M24308/24-119	DEM99PXNMBK52
M24308/24-120	DAM15PXNMBK52
M24308/24-121	DBM25PXNMBK52
M24308/24-122	DCM37PXNMBK52
M24308/24-123	DDM50PXNMBK52
M24308/24-125	DEM99PDNMBK52
M24308/24-126	DAM15PDNMBK52
M24308/24-127	DBM25PDNMBK52
M24308/24-128	DCM37PDNMBK52
M24308/24-129	DDM50PDNMBK52
M24308/24-131	DEM99PLNMBK52
M24308/24-132	DAM15PLNMBK52
M24308/24-133	DBM25PLNMBK52
M24308/24-134	DCM37PLNMBK52
M24308/24-135	DDM50PLNMBK52
M24308/24-137	DEM99PANMBK52
M24308/24-138	DAM15PANMBK52
M24308/24-139	DBM25PANMBK52
M24308/24-140	DCM37PANMBK52
M24308/24-141	DDM50PANMBK52
M24308/24-143	DEM99PGNMBK52
M24308/24-144	DAM15PGNMBK52
M24308/24-145	DBM25PGNMBK52
M24308/24-146	DCM37PGNMBK52
M24308/24-147	DDM50PGNMBK52
M24308/24-149	DEM99PSNMBK52
M24308/24-150	DAM15PSNMBK52
M24308/24-151	DBM25PSNMBK52
M24308/24-152	DCM37PSNMBK52
M24308/24-153	DDM50PSNMBK52
M24308/24-155	DEM99PWNMBK52
M24308/24-156	DAM15PWNMBK52
M24308/24-157	DBM25PWNMBK52
M24308/24-158	DCM37PWNMBK52
M24308/24-159	DDM50PWNMBK52
M24308/24-161Z	DEMAM15PMNMBK52
M24308/24-162Z	DAMAM25PMNMBK52
M24308/24-163Z	DBMAM44PMNMBK52
M24308/24-164Z	DCMAM62PMNMBK52
M24308/24-165Z	DDMAM78PMNMBK52
M24308/24-167Z	DEMAM15PQNMBK52
M24308/24-168Z	DAMAM25PQNMBK52
M24308/24-169Z	DBMAM44PQNMBK52
M24308/24-170Z	DCMAM62PQNMBK52
M24308/24-171Z	DDMAM78PQNMBK52
M24308/24-173Z	DEMAM15PANMBK52
M24308/24-174Z	DAMAM25PANMBK52
M24308/24-175Z	DBMAM44PANMBK52
M24308/24-176Z	DCMAM62PANMBK52
M24308/24-177Z	DDMAM78PANMBK52
M24308/24-201Z	DEM99PMNM
M24308/24-201F	DEM99PMNM-A101
M24308/24-201P	DEM99PMNM-F225
M24308/24-202Z	DAM15PMNM
M24308/24-202F	DAM15PMNM-A101
M24308/24-202P	DAM15PMNM-F225
M24308/24-203Z	DBM25PMNM

Dimensions shown in inches (mm)
 Specifications and dimensions subject to change

www.ittcannon.com



D Sub

M24308 Cross Reference

Gov't Designation	ITT Part Number
M24308/24-203F	DBMM25PMNM-A101
M24308/24-203P	DBMM25PMNM-F225
M24308/24-204Z	DCMM37PMNM
M24308/24-204F	DCMM37PMNM-A101
M24308/24-204P	DCMM37PMNM-F225
M24308/24-205Z	DDMM50PMNM
M24308/24-205F	DDMM50PMNM-A101
M24308/24-205P	DDMM50PMNM-F225
M24308/24-207Z	DEMM9PZNM
M24308/24-207F	DEMM9PZNM-A101
M24308/24-207P	DEMM9PZNM-F225
M24308/24-208Z	DAMM15PZNM
M24308/24-208F	DAMM15PZNM-A101
M24308/24-208P	DAMM15PZNM-F225
M24308/24-209Z	DBMM25PZNM
M24308/24-209F	DBMM25PZNM-A101
M24308/24-209P	DBMM25PZNM-F225
M24308/24-210Z	DCMM37PZNM
M24308/24-210F	DCMM37PZNM-A101
M24308/24-210P	DCMM37PZNM-F225
M24308/24-211Z	DDMM50PZNM
M24308/24-211F	DDMM50PZNM-A101
M24308/24-211P	DDMM50PZNM-F225
M24308/24-213Z	DEMM9PHNM
M24308/24-213F	DEMM9PHNM-A101
M24308/24-213P	DEMM9PHNM-F225
M24308/24-214Z	DAMM15PHNM
M24308/24-214F	DAMM15PHNM-A101
M24308/24-214P	DAMM15PHNM-F225
M24308/24-215Z	DBMM25PHNM
M24308/24-215F	DBMM25PHNM-A101
M24308/24-215P	DBMM25PHNM-F225
M24308/24-216Z	DCMM37PHNM
M24308/24-216F	DCMM37PHNM-A101
M24308/24-216P	DCMM37PHNM-F225
M24308/24-217Z	DDMM50PHNM
M24308/24-217F	DDMM50PHNM-A101
M24308/24-217P	DDMM50PHNM-F225
M24308/24-219Z	DEMM9PXNM
M24308/24-219F	DEMM9PXNM-A101
M24308/24-219P	DEMM9PXNM-F225
M24308/24-220Z	DAMM15PXNM
M24308/24-220F	DAMM15PXNM-A101
M24308/24-220P	DAMM15PXNM-F225
M24308/24-221Z	DBMM25PXNM
M24308/24-221F	DBMM25PXNM-A101
M24308/24-221P	DBMM25PXNM-F225
M24308/24-222Z	DCMM37PXNM
M24308/24-222F	DCMM37PXNM-A101
M24308/24-222P	DCMM37PXNM-F225
M24308/24-223Z	DDMM50PXNM
M24308/24-223F	DDMM50PXNM-A101
M24308/24-223P	DDMM50PXNM-F225
M24308/24-225Z	DEMM9PDNM
M24308/24-225F	DEMM9PDNM-A101
M24308/24-226Z	DAMM15PDNM
M24308/24-226F	DAMM15PDNM-A101
M24308/24-227Z	DBMM25PDNM
M24308/24-227F	DBMM25PDNM-A101

Gov't Designation	ITT Part Number
M24308/24-228Z	DCMM37PDNM
M24308/24-228F	DCMM37PDNM-A101
M24308/24-229Z	DDMM50PDNM
M24308/24-229F	DDMM50PDNM-A101
M24308/24-231Z	DEMM9PLNM
M24308/24-231F	DEMM9PLNM-A101
M24308/24-232Z	DAMM15PLNM
M24308/24-232F	DAMM15PLNM-A101
M24308/24-233Z	DBMM25PLNM
M24308/24-233F	DBMM25PLNM-A101
M24308/24-234Z	DCMM37PLNM
M24308/24-234F	DCMM37PLNM-A101
M24308/24-235Z	DDMM50PLNM
M24308/24-235F	DDMM50PLNM-A101
M24308/24-237Z	DEMM9PANM
M24308/24-237F	DEMM9PANM-A101
M24308/24-238Z	DAMM15PANM
M24308/24-238F	DAMM15PANM-A101
M24308/24-239Z	DBMM25PANM
M24308/24-239F	DBMM25PANM-A101
M24308/24-240Z	DCMM37PANM
M24308/24-240F	DCMM37PANM-A101
M24308/24-241Z	DDMM50PANM
M24308/24-241F	DDMM50PANM-A101
M24308/24-243Z	DEMM9PGNM
M24308/24-243F	DEMM9PGNM-A101
M24308/24-244Z	DAMM15PGNM
M24308/24-244F	DAMM15PGNM-A101
M24308/24-245Z	DBMM25PGNM
M24308/24-245F	DBMM25PGNM-A101
M24308/24-246Z	DCMM37PGNM
M24308/24-246F	DCMM37PGNM-A101
M24308/24-247Z	DDMM50PGNM
M24308/24-247F	DDMM50PGNM-A101
M24308/24-249Z	DEMM9PSNM
M24308/24-249F	DEMM9PSNM-A101
M24308/24-250Z	DAMM15PSNM
M24308/24-250F	DAMM15PSNM-A101
M24308/24-251Z	DBMM25PSNM
M24308/24-251F	DBMM25PSNM-A101
M24308/24-252Z	DCMM37PSNM
M24308/24-252F	DCMM37PSNM-A101
M24308/24-253Z	DDMM50PSNM
M24308/24-253F	DDMM50PSNM-A101
M24308/24-255Z	DEMM9PWNM
M24308/24-255F	DEMM9PWNM-A101
M24308/24-256Z	DAMM15PWNM
M24308/24-256F	DAMM15PWNM-A101
M24308/24-257Z	DBMM25PWNM
M24308/24-257F	DBMM25PWNM-A101
M24308/24-258Z	DCMM37PWNM
M24308/24-258F	DCMM37PWNM-A101
M24308/24-259Z	DDMM50PWNM
M24308/24-259F	DDMM50PWNM-A101
M24308/24-261Z	DEMAM15PMNM
M24308/24-261F	DEMAM15PMNM-A101
M24308/24-261P	DEMAM15PMNM-F225
M24308/24-262Z	DAMAM25PMNM
M24308/24-262F	DAMAM25PMNM-A101

Gov't Designation	ITT Part Number
M24308/24-262P	DAMAM25PMNM-F225
M24308/24-263Z	DBMAM44PMNM
M24308/24-263F	DBMAM44PMNM-A101
M24308/24-263P	DBMAM44PMNM-F225
M24308/24-264Z	DCMAM62PMNM
M24308/24-264F	DCMAM62PMNM-A101
M24308/24-264P	DCMAM62PMNM-F225
M24308/24-265Z	DDMAM78PMNM
M24308/24-265F	DDMAM78PMNM-A101
M24308/24-265P	DDMAM78PMNM-F225
M24308/24-267Z	DEMAM15PQNM
M24308/24-267F	DEMAM15PQNM-A101
M24308/24-267P	DEMAM15PQNM-F225
M24308/24-268Z	DAMAM25PQNM
M24308/24-268F	DAMAM25PQNM-A101
M24308/24-268P	DAMAM25PQNM-F225
M24308/24-269Z	DBMAM44PQNM
M24308/24-269F	DBMAM44PQNM-A101
M24308/24-269P	DBMAM44PQNM-F225
M24308/24-270Z	DCMAM62PQNM
M24308/24-270F	DCMAM62PQNM-A101
M24308/24-270P	DCMAM62PQNM-F225
M24308/24-271Z	DDMAM78PQNM
M24308/24-271F	DDMAM78PQNM-A101
M24308/24-271P	DDMAM78PQNM-F225
M24308/24-273Z	DEMAM15PANM
M24308/24-273F	DEMAM15PANM-A101
M24308/24-274Z	DAMAM25PANM
M24308/24-274F	DAMAM25PANM-A101
M24308/24-275Z	DBMAM44PANM
M24308/24-275F	DBMAM44PANM-A101
M24308/24-276Z	DCMAM62PANM
M24308/24-276F	DCMAM62PANM-A101
M24308/24-277Z	DDMAM78PANM
M24308/24-277F	DDMAM78PANM-A101
M24308/26-1	D20418-128
M24308/26-1F	D20418-2
M24308/26-2	D20418-129
M24308/26-2F	D20418-39

D Sub



ITT

Dimensions shown in inches (mm)
Specifications and dimensions subject to change

www.ittcannon.com

NASA Part Number Reference

S-311-P Specification	ITT Part Number
311P10-1P-B-12	DEM-9P-NMB-K52
311P10-1P-C-12	DEM-9P-NMC-K52
311p10-1S-B-12	DEM-9S-NMB-K52
311P10-1S-C-12	DEM-9S-NMC-K52
311P10-2P-C-12	DAM-15P-NMC-K52
311P10-2S-B-12	DAM-15S-NMB-K52
311P10-2S-C-12	DAM-15S-NMC-K52
311P10-3P-B-12	DBM-25P-NMB-K52
311P10-3P-C-12	DBM-25P-NMC-K52
311P10-3S-B-12	DBM-25S-NMB-K52
311P10-3S-C-12	DBM-26S-NMC-K52
311P10-4P-B-12	DCM-37P-NMB-K52
311P10-4P-C-12	DCM-37P-NMC-K52
311P10-4S-B-12	DCM-37S-NMB-K52
311P10-4S-C-12	DCM-37S-NMC-K52
311P10-5P-B-12	DDM-50P-NMB-K52
311P10-5P-C-12	DDM-50P-NMC-K52
311P10-5S-B-12	DDM-50S-NMB-K52
311P10-5S-C-12	DDM-50S-NMC-K52
311P10-6P-B-12	DEM-5W1P-NMB-K52
311P10-6P-C-12	DEM-5W1P-NMC-K52
311P10-6S-B-12	DEM-5W1S-NMB-K52
311P10-6S-C-12	DEM-5W1S-NMC-K52
311P10-7P-B-12	DAM-3W3P-NMB-K52
311P10-7P-C-12	DAM-3W3P-NMC-K52
311P10-7S-B-12	DAM-3W3S-NMB-K52
311P10-7S-C-12	DAM-3W3S-NMC-K52
311P10-8P-B-12	DAM-7W2P-NMB-K52
311P10-8P-C-12	DAM-7W2P-NMC-K52
311P10-8S-B-12	DAM-7W2S-NMB-K52
311P10-8S-C-12	DAM-7W2S-NMC-K52
311P10-9P-B-12	DAM-11W1P-NMB-K52
311P10-9P-C-12	DAM-11W1P-NMC-K52
311P10-9S-B-12	DAM-11W1S-NMB-K52
311P10-9S-C-12	DAM-11W1S-NMC-K52
311P10-10P-B-12	DBM-5W5P-NMB-K52
311P10-10P-C-12	DBM-5W5P-NMC-K52
311P10-10S-B-12	DBM-5W5S-NMB-K52
311P10-10S-C-12	DBM-5W5S-NMC-K52
311P10-11P-B-12	DBM-9W4P-NMB-K52
311P10-11P-C-12	DBM-9W4P-NMC-K52
311P10-11S-B-12	DBM-9W4S-NMB-K52
311P10-11S-C-12	DBM-9W4S-NMC-K52
311P10-12P-B-12	DBM-13W3P-NMB-K52
311P10-12P-C-12	DBM-13W3P-NMC-K52
311P10-12S-B-12	DBM-13W3S-NMB-K52
311P10-12S-C-12	DBM-13W3S-NMC-K52
311P10-13P-B-12	DBM-17W2P-NMB-K52
311P10-13P-C-12	DBM-17W3P-NMC-K52
311P10-13S-B-12	DBM-17W2S-NMB-K52
311P10-13S-C-12	DBM-13W3S-NMC-K52

S-311-P Specification	ITT Part Number
311P10-14P-B-12	DBM-21W1P-NMB-K52
311P10-14P-C-12	DBM-21W1P-NMC-K52
311P10-14S-B-12	DBM-21W1S-NMB-K52
311P10-14S-C-12	DBM-21W1S-NMC-K52
311P10-15P-B-12	DCM-8W8P-NMB-K52
311P10-15P-C-12	DCM-8W8P-NMC-K52
311P10-15S-B-12	DCM-8W8S-NMB-K52
311P10-15S-C-12	DCM-8W8S-NMC-K52
311P10-16P-B-12	DCM-13W6P-NMB-K52
311P10-16P-C-12	DCM-13W6P-NMC-K52
311P10-16S-B-12	DCM-13W6S-NMB-K52
311P10-16S-C-12	DCM-13W6S-NMC-K52
311P10-17P-B-12	DCM-17W5P-NMB-K52
311P10-17P-C-12	DCM-17W5P-NMC-K52
311P10-17S-C-12	DCM-17W5S-NMC-K52
311P10-18P-B-12	DCM-21WA4P-NMB-K52
311P10-18P-C-12	DCM-21WA4P-NMC-K52
311P10-18S-B-12	DCM-21WA4S-NMB-K52
311P10-18S-C-12	DCM-21WA4S-NMC-K52
311P10-23P-B-12	DDM-36W4P-NMB-K52
311P10-23P-C-12	DDM-36W4S-NMC-K52
311P10-23S-B-12	DDM-36W4S-NMB-K52
311P10-23S-C-12	DDM-36W4S-NMC-K52
311P10-24P-B-12	DDM-43W2P-NMB-K52
311P10-24P-C-12	DDM-43W2S-NMC-K52
311P10-24S-B-12	DDM-43W2S-NMB-K52
311P10-24S-C-12	DDM-43W2S-NMC-K52
311P10-25P-B-12	DDM-47W1P-NMB-K52
311P10-25P-C-12	DDM-47W1P-NMC-K52
311P10-25S-B-12	DDM-47W1S-NMB-K52
311P10-25S-C-12	DDM-47W1S-NMC-K52
311P10-25P-B-12	DDM-47W1P-NMB-K52
311P10-25P-C-12	DDM-47W1P-NMC-K52
311P10-25S-B-12	DDM-47W1S-NMB-K52
311P10-25S-C-12	DDM-47W1S-NMC-K52
311P405-9P-B-12	DAA-11W1P-NMB-K52
311P405-9S-B-12	DAA-11W1S-NMB-K52
311P405-10P-B-12	DAM-5W5P-NMB-K52
311P405-10S-B-12	DAM-5W5S-NMB-K52
311P405-11P-B-12	DAM-9W4P-NMB-K52
311P405-12P-B-12	DBA-13W3P-NMB-K52
311P405-12S-B-12	DBA-13W3S-NMB-K52
311P405-13P-B-12	DBMA-17W2P-NMB-K52
311P405-13S-B-12	DBMA-17W2S-NMB-K52
311P405-14P-B-12	DCA-21W1P-NMB-K52
311P405-15P-B-12	DCM-8W8P-NMB-K52
311P405-15S-B-12	DCM-8W8S-NMB-K52
311P405-18P-B-12	DCA-21W1P-NMB-K52
311P405-18S-B-12	DCA-21WA1S-NMB-K52
311P405-24S-B-12	DDA-43W2S-NMB-K52
311P407-1P-B-12	DEMA-15P-NMB-K47FO
311P407-1S-B-12	DEMA-15S-NMB-K47FO
311P407-2P-B-12	DAMA-26P-NMB-K47FO

S-311-P Specification	ITT Part Number
311P407-2S-B-12	DAMA-26S-NMB-K47FO
311P407-3P-B-12	DBMA-44P-NMB-K47FO
311P407-3S-B-12	DBMA-44S-NMB-K47FO
311P407-4P-B-12	DCMA-62P-NMB-K47FO
311P407-4S-B-12	DCMA-62S-NMB-K47FO
311P407-5P-B-12	DDMA-78P-NMB-K47FO
311P407-5S-B-12	DDMA-78S-NMB-K47FO
311P409-1P-B-12	DEMA-9P-NMB-K47FO
311P409-1S-B-12	DEMA-9S-NMB-K47FO
311P409-2P-B-12	DAMA-15P-NMB-K47FO
311P409-2S-B-12	DAMA-15S-NMB-K47FO
311P409-3P-B-12	DBMA-25P-NMB-K47FO
311P409-3S-B-12	DBMA-25S-NMB-K47FO
311P409-4P-B-12	DCMA-37-NMB-K47FO
311P409-4S-B-12	DCMA-37S-NMB-K47FO
311P409-5P-B-12	DDMA-50P-NMB-K47FO
311P409-5S-B-12	DDMA-50S-NMB-K47FO
G08P1	030-2042-002
G08S1	031-1147-002
G10P1	330-5291-037
G10S1	031-1007-052
GCP1	DM53740-17
GCP2	DM53740-15
GCP3	DM53740-16
GCP4	DM53740-18
GCRP1	DM53741-12
GCRP2	DM53741-11
GCRP3	DM53741-10
GCRP4	DM53741-13
GCS1	DM53742-18
GCS2	DM53742-16
GCS3	DM53742-17
GCS4	DM53742-19
GCSR1	DM43743-18
GCSR2	DM43743-16
GCSR3	DM43743-17
GCSR4	DM43743-19
GHP6	DM51157-8
GHRP6	DM51157-5005
GHR6	DM51155-5004
GHS6	DM51155-7

D Sub

Dimensions shown in inches (mm)
 Specifications and dimensions subject to change

www.ittcannon.com



X-ON Electronics

Largest Supplier of Electrical and Electronic Components

Click to view similar products for [Circular MIL Spec Connector](#) category:

Click to view products by [ITT](#) manufacturer:

Other Similar products are found below :

[89075GULPR](#) [0025-262-542](#) [0025-264-3014](#) [58-570121-04S](#) [0134-213-1208](#) [0134-213-2209](#) [0025-258-000](#) [60-042022-07P](#) [60-042022-19P](#)
[60-042022-23P](#) [60-042217-10P](#) [0114-201-1278](#) [012-0467-000](#) [602GB06EG24-61SN](#) [0134-201-1207](#) [0134-213-1006](#) [6104-207-2302](#) [6104-](#)
[208-1902](#) [61-168211-04P](#) [61-168617-10P](#) [6131-202-19149P](#) [6131-204-21149P](#) [6131-208-13149P](#) [6131-209-17149P](#) [6131-210-11149P](#) [6131-](#)
[211-19149P](#) [6131-216-19149P](#) [6131-259-21149P](#) [6131-259-23149P](#) [6131-265-17149P](#) [6131-265-19149P](#) [CS3100A18-1P-472](#) [CS3100A-36-](#)
[77P](#) [CS3101A-16-55P](#) [CS3102A-10SL-55P](#) [CS3102A-14S-58P](#) [CS3102A-32-17P](#) [CS3102A32-25S](#) [CS3102C18-4P-472](#)
[CS3106A10SL3S004](#) [CS3106A-18-73S](#) [CS3108A-14S-52S](#) [CS3108A-28-51S](#) [6162-233-1277](#) [6162-324-1231](#) [M243082296Z](#)
[M2884010AC1S1](#) [CT0-24-10SC](#) [CT0M20-7PCAU](#) [M28840/17AC1G3](#)