

cannon

CA Threaded Catalog



ITT

Proven Quality, Reliability & Expertise

ITT Cannon is a leading global manufacturer of connector products serving international customers in the aerospace and defense, medical, energy, transportation and industrial end markets.

Whether delivering critical specs to aircraft pilots, streaming data through communications satellites or giving expectant parents a first look at their unborn children, Cannon connects the world's most important information to the people who need it.



About ITT

ITT is a diversified leading manufacturer of highly engineered critical components and customized technology solutions for the energy, transportation and industrial markets. Building on its heritage of innovation, ITT partners with its customers to deliver enduring solutions to the key industries that underpin our modern way of life.

Founded in 1920, ITT is headquartered in Stamford, Connecticut, with employees in more than 35 countries and sales in a total of approximately 125 countries. For more information, visit itt.com



Industrial / Instrumentation



Defense Vehicles



Medical



Heavy Equipment



Rail



Oil & Gas



Commercial & Military Aerospace

Our connector portfolio remains the most extensive in the industry.

Offering a reliable and cost effective range of interconnect solutions.

Introduction

ITT Cannon's circular metal connector series CA Threaded is one of the market standards for harsh environment applications in commercial as well as military applications. Derived from the military standard MIL-C-5015 the product portfolio expanded to meet the needs of industrial and heavy vehicle applications around the globe. As a result the commercial offering exceeds the military portfolio by more than 30%.

Features and benefits

CA Threaded offers a range of features and benefits to customers in all kind of industrial and heavy vehicle markets:

- Threaded coupling mechanism offering extraordinary vibration resistance
- A wide range of contacts for both solder and crimp applications allowing to connect the full wire range up to 50mm² cross section
- An extensive range of backshells offering connections of all typical cable solutions with individual wires or jacket cables in shielded or unshielded versions
- Materials that allow to meet the stringent requirements of industrial and especially heavy vehicle markets as
 - temperatures ranging from -55°C up to +200°C
 - media resistance* as brake liquids, gasoline, lubricants and others
 - RoHS compliant product versions including Military VG approved A241 Tin Zinc Matt Grey and Industrial A240 Zinc Nickel Blue Generation plated products

Contact us for detail or your request for a customized solution.

*short time wetting

This document solely applies to European manufactured CA Threaded products.

This document solely applies to European manufactured CA Threaded products
Dimensions shown in mm | Specifications and dimensions subject to change

How to use

This catalog is split in several sections to provide...

- A brief introduction to ITT Cannon and CA Threaded
- A general overview of the CA Threaded product lines
- Detailed product information including contact arrangements, performance and part number data
- Detailed supporting information including accessories and tooling

The fastest way to find your product of choice is to follow these steps

1 **Select your product** using the “ordering reference” option

3 **Add accessories and tooling options** on the related pages. A connector assembly instruction is available upon request or visit www.ittcannon.com

2 **Use the detail pages** to better understand the available options like connector styles, contact arrangements and contacts options

4 **Use the contact information** on the back cover to contact us for further questions or to get advise on where you can purchase our products

Table of contents

How to use this catalogue.....	5
Product overview	7
Ordering reference.....	8
Endbell Modification -F42	9
Contact arrangements.....	10-22
Mounting dimensions	23
Separating and coupling dimensions	24
Wall mounting receptacles	25-27
Cable connecting plugs.....	28-30
Box mounting receptacles	31-32
Straight and right angle plugs.....	33-37
Accessories	38-42
Contacts	43-44
CA Layout Overview.....	45-46
Tooling.....	47-48

Product overview

ELECTRICAL DATA

Contact Rating at 20°C (68°F), ambient temperature

Contact size (AWG/metric)	Rated Current (A _{max.}) ¹
20/10	8
16S/15S	22
16/15	22
12	41
8/60/100	74
4/160	135
0/500	245

¹This applies only to the max. rated current for one contact. If several contacts in one contact arrangement are loaded with higher current the temperature may not exceed 125°C

Rated Current vs. Ambient Temperature

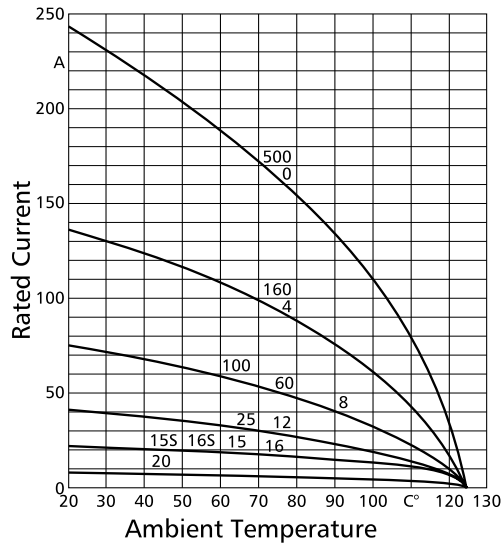

Contacts Resistance (Millivolt test)

Contact size (AWG/metric)	Contact resistance mΩ max.
20/10	12,0
16S/15S	6,0
16/15	6,0
12/25	3,0
8/100	1,0
4/160	0,3
0/500	0,2

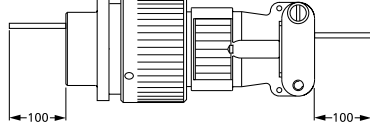

Insulation Resistance

Standard insulator material >1000 MΩ
FKM insulator material (upon request) >5000 MΩ

Air and Creepage Path (min.)

Voltage class	Instr.	A	D	E
Air path, mm	0,7	1,1	2,8	4,8
Creepage path, mm	0,7	1,1	2,8	4,8

Operation Voltage

Operating voltage for CA Threaded connectors is limited to 50VAC / 75VDC according to the safety regulations defined in the European Low Voltage Directive (LVD) 2014/35/EU. For other uses or regions please see appropriate regional regulations.

This document solely applies to European manufactured CA Threaded products
Dimensions shown in mm | Specifications and dimensions subject to change

Test voltage

Service rating	Test voltage V _{rms}
Instruments	1050
A	1600
B	4500
D	2500
E	3000

MECHANICAL FEATURES

Ambient temperature

Neoprene: -55/125°C (-67/257°F), FKM: -30/200°C (-22/392°F)*

ENVIRONMENTAL SEALING

Up to IP 65 (in mated condition) Acc. to DIN EN 60068-1

Mating Cycles min. 500

Min. Separating Force per Contact

Contact size		Separating force
metric	AWG	N min
10	20	0,3
15S/15	16S/16	1,0
25	12	1,5
60/100	8	3,0
160	4	4,0
500	0	8,5

Contact Retention Apply test force in mating direction

Contact size		Test force
metric	AWG	N
10	20	30
15S/15	16S/16	35
25	12	55
60/100	8	80
160	4	90
500	0	95

Coupling Torque

The admissible coupling torque has to be tested under harnessed condition

Shell size	Admissible torque	
	Closing and opening (Nm _{max})	Opening (Nm _{min})
10SL	3,0	0,15
12S	2,8	0,23
14S	5,9	0,35
16S/16	7,0	0,46
18	8,0	0,58
20	9,0	0,70
22	10,6	0,80
24	12,9	0,80
28	16,7	0,92
32	18,1	1,02
36	23,9	1,05

Materials

Shell	Aluminum alloy
Contacts	Copper alloy, silver plated or gold plated
Insulator/Grommet	Polychloroprene (Standard) FKM (High temperature)

* consult factory

Ordering reference

Part number explanation

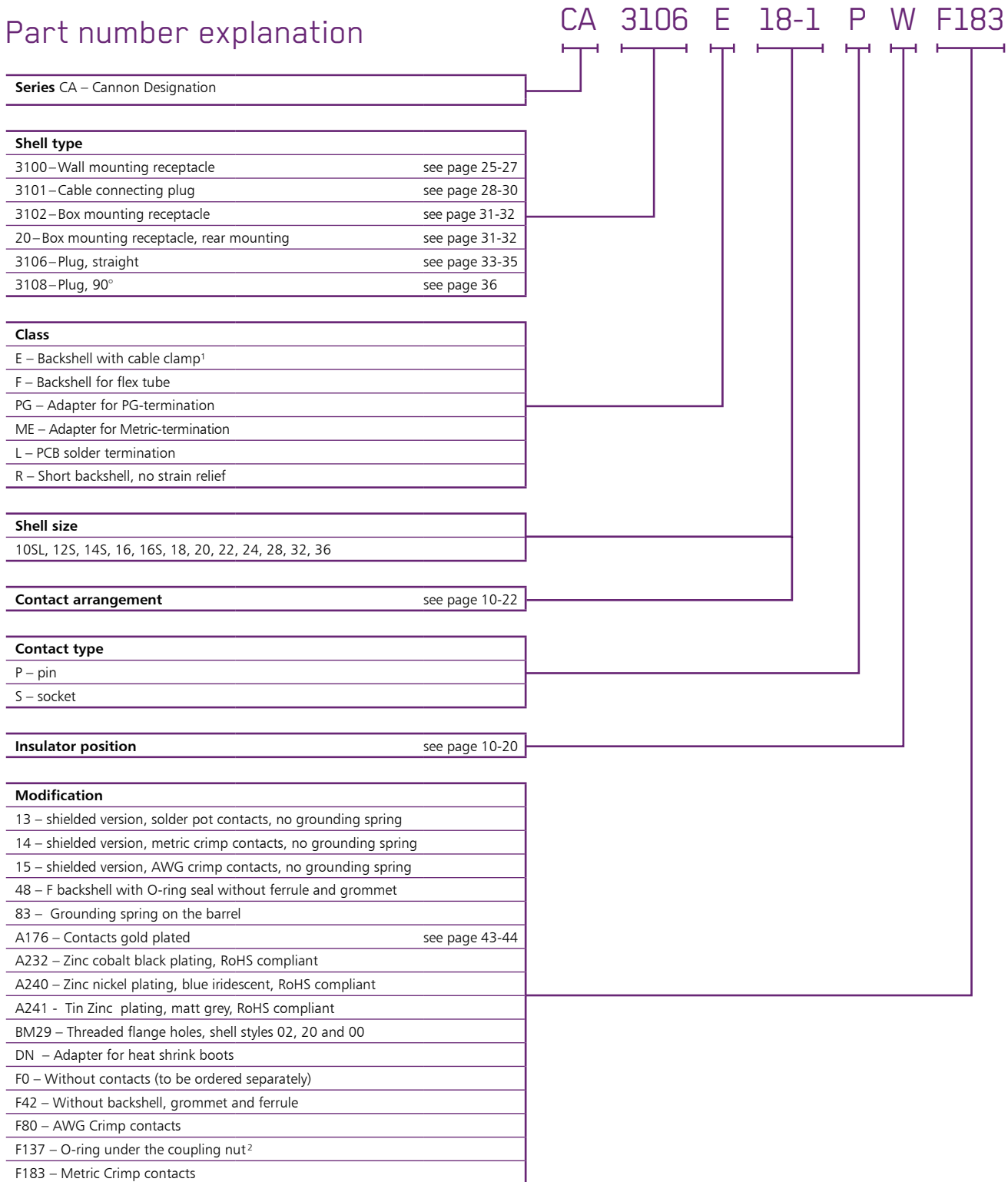

¹ except shell style 02/20 ² a number of plugs are already featured with this O-ring

Default for any CA Threaded connector is solder cup contacts. Unless one of the contact modification codes listed above is used the connectors will be supplied with solder cup contacts.

This document solely applies to European manufactured CA Threaded products.

This document solely applies to European manufactured CA Threaded products
Dimensions shown in mm | Specifications and dimensions subject to change







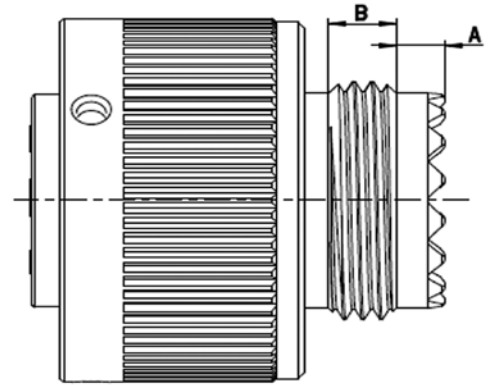









ENDBELL MODIFICATION -F42

Below table shows the different threads that come with the respective shell sizes when choosing the modification -F42 (no endbell/grommet seal). This modification is only applicable to styles 0 (wall mounting receptacle), 1 (cable connecting plug), 6 (straight plug) and 8 (90° angled plug).

Shell size	Thread	A +/- 0,1 (mm)	B (mm)
10SL	9/16-24UNEF-2A	3.40	5.05
12S	5/8-24UNEF-2A	3.4	4.7
14S	3/4-20UNEF-2A	3.4	4.7
16	7/8-20UNEF-2A	4.1	7.6
16S	7/8-20UNEF-2A	4.1	4
18	1-20UNEF-2A	3.5	6.9
20	1 1/8-18UNEF-2A	4.6	5.5
22	1 1/4-18UNEF-2A	4.6	5.5
24	1 3/8-18UNEF-2A	4.6	7.2
28	1 5/8-18UNEF-2A	4.6	7.2
32	1 7/8-16UNEF-2A	4.6	7.9
36	2 1/8-16UN-2A	4.6	7.9



















CONTACT ARRANGEMENTS

View on Mating face of Pin Insulator	No. of Contacts	Contact arrangement Contact size	Service rating	Insulator position				Position	Special polarization
				W	X	Y	Z		
	3	10SL-3 16S	A	–	–	–	–	–	–
	2	10SL-4 16S	A	–	–	–	–	–	–
◆ 	2	12S-3 16S	A	70	145	215	290	–	–
	1	12S-4 16S	D	–	–	–	–	–	–
	4	12SA10 16S	Instr.	–	–	–	–	3 8	110 250
	3	14S-1 16S	A	–	–	–	–	–	–
	4	14S-2 16S	Instr.	–	120	240	–	–	–
	1	14S-4 16S	D	–	–	–	–	–	–
	5	14S-5 16S	Instr.	–	110	–	–	–	–
	6	14S-6 16S	Instr.	–	–	–	–	–	–
◆ 	3	14S-7 16S	A	90	180	270	–	–	–
	2	14S-9 16S	Instr.	70	145	215	290	–	–
	7	14SA7 16S	Instr.	–	–	–	–	–	–
◆ 	7	16S-1 16S	A	80	–	–	280	–	–
	2	16S-4 16S	D	35	110	250	325	–	–
◆ 	3	16S-5 16S	A	70	145	215	290	–	–
	5	16S-8 16S	A	–	170	265	–	–	–

◆Attention: For all insert rotations, it is possible for miss-mating to occur. It is the responsibility of the customer to ensure they have selected correctly.

















CONTACT ARRANGEMENTS

View on Mating face of Pin Insulator	No. of Contacts	Contact arrangement Contact size	Service rating	Insulator position				Position	Special polarization
				W	X	Y	Z		
	3 2 1	16-7 16 8	A	80	110	250	280	-	-
	4 2 2	16-9 12 16	A	35	110	250	325	-	-
◆ 	3	16-10 12	A	90	180	270	-	-	-
	2	16-11 12	A	35	110	250	325	-	-
	1	16-12 4	A	-	-	-	-	-	-
	2	16A11 12	A	35	110	250	325	-	-
◆ 	10	18-1 16	A (B, C, F, G) Instr. (all others)	70	145	215*	290	-	-
	2	18-3 12	D	35	110	250	325	-	-
	4	18-4 16	D	35	110	250	325	-	-
	3 2 1	18-5 12 16	D	80	110	250	280	-	-
	1	18-6 4	D	-	-	-	-	-	-
	1	18-7 8	D	-	-	-	-	-	-
	8 1 7	18-8 12 16	A	70	-	-	290	-	-
	7 2 5	18-9 12 16	Instr.	80	110	250	280	-	-
	4	18-10 12	A	-	120	240	-	-	-
	5	18-11 12	A	-	170	265	-	-	-
	6	18-12 16	A	80	-	-	280	-	-

*Caution: This insulator rotation is not recommended as it can mate with normal rotation connectors.

◆Attention: For all insert rotations, it is possible for miss-mating to occur. It is the responsibility of the customer to ensure they have selected correctly.

CONTACT ARRANGEMENTS

View on Mating face of Pin Insulator	No. of Contacts	Contact arrangement Contact size	Service rating	Insulator position				Position	Special polarization
				W	X	Y	Z		
	4 1 3	18-13 8 12	A	80	110	250	280	-	-
	7 2 5	18-17 12 16	Instr.	-	-	-	-	12	100
	10	18-19 16	A	-	120	240	-	-	-
	5	18-20 16	A	90	180	270	-	-	-
	3	18-21 12	A	-	-	-	-	-	-
	3	18-22 16	D	70	145	215	290	-	-
	1	20-2 0	D	-	-	-	-	-	-
	3	20-3 12	D	70	145	215	290	-	-
	4	20-4 12	D	45	110	250	-	-	250 (20A37)
	3	20-6 16	D	-	-	-	-	-	-
	8	20-7 16	A (C, D, E, F) D (A, B, H, G)	80	110	250	280	-	-
	6 2 4	20-8 8 16	Instr.	80	110	250	280	-	-
	13	20-11 16	Instr.	-	-	-	-	-	-
	5 3 2	20-14 12 8	A	80	110	250	280	-	-
	7	20-15 12	A	80	-	-	280	-	-
	9 2 7	20-16 12 16	A	80	110	250	280	-	-
	6 5 1	20-17 12 16	A	90	180	270	-	-	-

◆Attention: For all insert rotations, it is possible for miss-mating to occur. It is the responsibility of the customer to ensure they have selected correctly.

CONTACT ARRANGEMENTS

View on Mating face of Pin Insulator	No. of Contacts	Contact arrangement Contact size	Service rating	Insulator position				Position	Special polarization
				W	X	Y	Z		
	9 3 6	20-18 12 16	A	35	110	250	325	–	–
	3	20-19 8	A	90	180	270	–	–	–
	6 3 3	20-22 8 16	A	80	◆ 110	◆ 250	280	–	–
	2	20-23 8	A	35	110	250	325	–	–
	4 2 2	20-24 8 16	A	35	110	250	325	–	–
	14	20-27 16	A	35	110	250	325	–	–
	17	20-29 16	A	80	–	–	280	–	–
	11	20-33 16	A	–	–	–	2 3 17	260 110 130	–
	9	20A9 12	Instr. (all others)	–	110	250	–	–	–
	24	20A24 20	–	–	–	–	–	–	–
No solder pot contacts available for #10/20									
	19	20A48 16	Instr.	–	80	280	–	–	–
	2	22-1 8	D	35	110	250	325	–	–
	3	22-2 8	D	70	145	215	290	–	–
	4 2 2	22-4 8 12	A	5	110	250	325	–	–
	6 2 4	22-5 12 16	D	35	110	250	325	–	–
	1	22-7 0	E	–	–	–	–	–	–

◆Attention: For all insert rotations, it is possible for miss-mating to occur. It is the responsibility of the customer to ensure they have selected correctly.

*Reduced contact termination 0,3mm².

This document solely applies to European manufactured CA Threaded products
Dimensions shown in mm | Specifications and dimensions subject to change

CONTACT ARRANGEMENTS

View on Mating face of Pin Insulator	No. of Contacts	Contact arrangement Contact size	Service rating	Insulator position				Position	Special polarization
				W	X	Y	Z		
	2	22-8 12	E	35	110	250	325	-	-
	3	22-9 12	E	70	145	215	290	-	-
	4	22-10 16	E	35	110	250	325	-	-
	5	22-12 8 16	D	80	110	250	280	-	-
	19	22-14 16	A	80	-	-	280	-	-
	6	22-15 12 16	A (A, B, C, E, F) E (D)	80	110	250	280	-	-
	9	22-16 12 16	A	80	110	250	280	-	-
	14	22-19 16	A	80	110	250	280	-	-
	9	22-20 16	A	35	110	250	325	-	-
	3	22-21 16 0	A	80	110	250	280	-	-
	4	22-22 8	A	-	110	250	-	-	-
	8	22-23 12	D (H) A (all others)	35	-	250	-	-	-
	9	22-27 8 16	A (A to H)	80	-	250	280	-	-
	7	22-28 12	A	80	-	-	280	-	-
	7	24-2 12	D	80	-	-	280	-	-

♦Attention: For all insert rotations, it is possible for miss-mating to occur. It is the responsibility of the customer to ensure they have selected correctly.

This document solely applies to European manufactured CA Threaded products
Dimensions shown in mm | Specifications and dimensions subject to change

CONTACT ARRANGEMENTS

View on Mating face of Pin Insulator	No. of Contacts	Contact arrangement Contact size	Service rating	Insulator position				Position	Special polarization
				W	X	Y	Z		
	4 1 3	24-4 0 16	D	80	110	250	280	–	–
	16	24-5 16	A	80	110	250	280	–	–
	16 2 14	24-7 12 16	A	80	110	250	280	–	–
	2	24-9 4	A	35	110	250	325	–	–
	7	24-10 8	A	80	–	–	280	–	–
	9 3 6	24-11 8 12	A	35	110	250	325	–	–
	5 2 3	24-12 4 12	A	80	110	250	280	–	–
	12	24-19 16	A	–	–	–	–	–	–
	11 2 9	24-20 12 16	D	80	110	250	280	–	–
	4	24-22 8	D	45	110	250		–	–
	7	24-27 16	E	80	–	–	280	–	–
	24	24-28 16	Instr.	80	110	250	280	–	–
	12	24A24 12	A	–	–	–	–	2 4 9 12	260 80 280 100
	28	24A28 16	Instr.	65	146	235	–	–	–
	19 13 5 1	24A51 16 12 8	A	–	–	–	–	14	30

This document solely applies to European manufactured CA Threaded products
Dimensions shown in mm | Specifications and dimensions subject to change

CONTACT ARRANGEMENTS

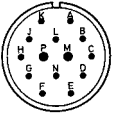
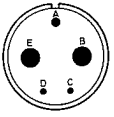
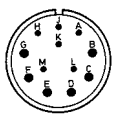
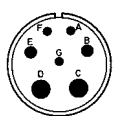
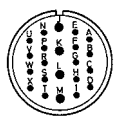
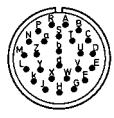
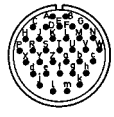
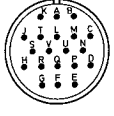
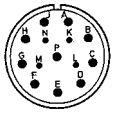
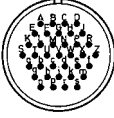
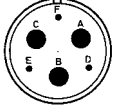
View on Mating face of Pin Insulator	No. of Contacts	Contact arrangement Contact size	Service rating	Insulator position				Position	Special polarization
				W	X	Y	Z		
	14 12 2	28-2 16 12	D	35	110	250	325	–	–
	5 2 2 1	28-5 4 16 12	D	35	110	250	325	–	–
	12 6 6	28-9 16 12	D	80	110	250	280	–	–
	7 2 2 3	28-10 4 8 12	A (= A, B, C, D, E, F) D (= G)	80	110	250	280	–	–
	22 4 18	28-11 12 16	A	80	110	250	280	–	–
	26	28-12 16	A	90	180	270	–	–	–
	35	28-15 16	A	80	110	250	280	–	–
	20	28-16 16	A (A-L) D (M, N, P)	80	110	250	280	–	–
	14 10 4	28-20 12 16	A	80	110	250	280	–	–
	37	28-21 16	A	80	110	250	280	–	–
	6 3 3	28-22 4 16	D	70	145	215	290	–	–

This document solely applies to European manufactured CA Threaded products
Dimensions shown in mm | Specifications and dimensions subject to change

CONTACT ARRANGEMENTS

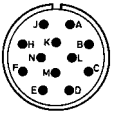
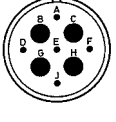
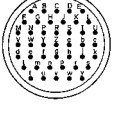
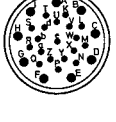
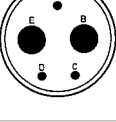
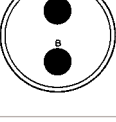
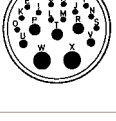
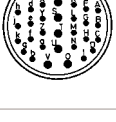
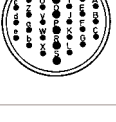
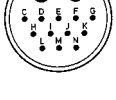
View on Mating face of Pin Insulator	No. of Contacts	Contact arrangement Contact size	Service rating	Insulator position				Position	Special polarization
				W	X	Y	Z		
	12	28-51 12	D	80	135	195	–	–	–
	9 4 5	28A16 4 16	A (e) Instr.	– – – –	– – – –	– – – –	– – – –	2 3 8 9	260 110 250 280
	43	28A51 16	A	– – – – –	– – – – –	– – – – –	– – – – –	3 4 8 9 12	110 80 250 280 100
	28 9 19	28A63 12 16	A	– – –	100 – –	260 – –	– – –	– – –	– – –
	5 2 3	32-1 0 12	E (A) D (all others)	80 – –	110 – –	250 – –	280 – –	– – –	– – –
	2	32-5 0	D	35 –	110 –	250 –	325 –	– –	– –
	23 2 3 2 16	32-6 4 8 12 16	A	80 – – –	110 – – –	250 – – –	280 – – –	– – – –	– – – –
	35 7 28	32-7 12 16	Instr. (A, B, U, I.) A (all others)	80 – –	125 – –	235 – –	280 – –	– – –	– – –
	30 6 24	32-8 12 16	A	80 – –	125 – –	235 – –	280 – –	– – –	– – –
	14 12 2	32-9 16 4	D	80 – –	110 – –	250 – –	280 – –	– – –	– – –



This document solely applies to European manufactured CA Threaded products
Dimensions shown in mm | Specifications and dimensions subject to change

CONTACT ARRANGEMENTS

View on Mating face of Pin Insulator	No. of Contacts	Contact arrangement Contact size	Service rating	Insulator position				Position	Special polarization
				W	X	Y	Z		
	23 5 18	32-13 12 16	D	80	110	250	280	–	–
	8 2 6	32-15 0 12	D	35	110	250	325	–	–
	4	32-17 4	D	45	110	250	–	–	–
	54	32A10 16	A	– 80 – – –	– 110 – – –	– 250 – – –	– 280 – – –	3 4 8 9 12	110 80 250 280 100
	47	32A47 16	– A	– – – – – –	– – – – – –	– – – – – –	– – – – – –	2 3 4 8 9 12	260 110 80 250 280 100
	55	32A55 16	A	80	110	250	280	–	–
	61 20 41	32A69 16 20	Instr.	–	110	250	–	–	–
No solder pot contacts available for #10/20 contacts.									
	6 3 3	36-3 0 12	D	70	145	215	290	–	–
	4	36-5 0	A	–	120	240	–	–	–

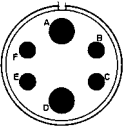
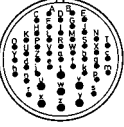

This document solely applies to European manufactured CA Threaded products
Dimensions shown in mm | Specifications and dimensions subject to change

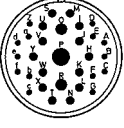
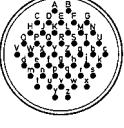
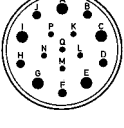
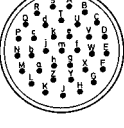
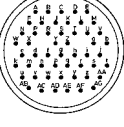
CONTACT ARRANGEMENTS

View on Mating face of Pin Insulator	No. of Contacts	Contact arrangement Contact size	Service rating	Insulator position				Position	Special polarization
				W	X	Y	Z		
	6 4 2	36-6 4 0	A	35	110	250	25	–	–
	47 7 40	36-7 12 16	A	80	110	250	280	–	–
	47 1 46	36-8 12 16	A	80	110	250	280	–	–
	31 14 14 2 1	36-9 16 12 8 4	A	80	125	235	280	–	–
	48	36-10 16	A	80	125	235	280	–	–
	16 5 5 6	36-14 8 12 16	D	–	–	–	–	–	–
	35	36-15 16	D (m) A (all others)	60	125	245	305	–	–
	52	36A34 16	A	–	–	–	–	2 3 4 8 9 12 20	260 110 80 250 280 100 220

This document solely applies to European manufactured CA Threaded products
Dimensions shown in mm | Specifications and dimensions subject to change

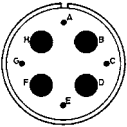
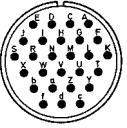
CONTACT ARRANGEMENTS

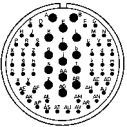
View on Mating face of Pin Insulator	No. of Contacts	Contact arrangement Contact size	Service rating	Insulator position				Position	Special polarization
				W	X	Y	Z		
	8 4 4	36A35 16 0	A	-	-	-	-	2 3 8 9	260 110 250 280
	27	36A46 12	A	-	-	-	-	2 3 4 8 9 12	260 110 80 250 280 100
	39 8 31	36A98 8 16	A	-	110	-	-	-	-
	65 15 50	36A99 16 20*	Instr.	30	135	-	-	-	-
No solder pot contacts available for #10/20 contacts.									

*Reduced contact termination 0,3 mm².

◆ Attention: For all insert rotations, it is possible for miss-mating to occur. It is the responsibility of the customer to ensure they have selected correctly.

ALTERNATE INSERT POSITION

Indicates location of centerline of key or keyway of shells in fixed normal position. Insert is rotated as shown by arrow and letters.

Tolerances:

Pin insulator 10SL-20: $\pm 2,0^\circ$

Pin insulator 22-36: $\pm 1,5^\circ$

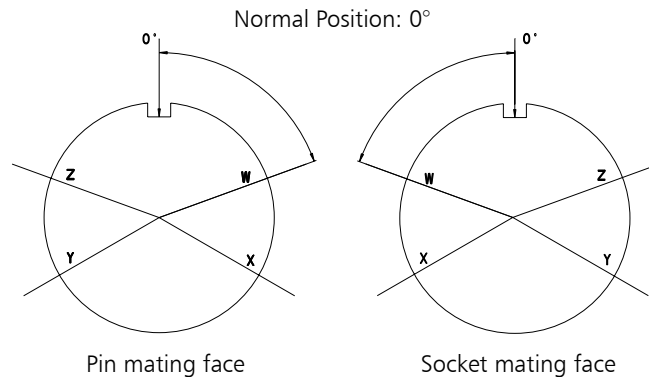

This document solely applies to European manufactured CA Threaded products
Dimensions shown in mm | Specifications and dimensions subject to change

CONTACT ARRANGEMENTS

Contact arrangement	No. of Contacts	Contact size					
		0	4	8	12	16	20
		500	160	100	25	15	10
12S4	1					1	
14S4	1					1	
16-12	1		1				
18-6	1		1				
18-7	1			1			
20-2	1	1					
22-7	1	1					
10SL4	2					2	
14S9	2					2	
16S4	2					2	
16-11	2				2		
16A11	2				2		
18-3	2				2		
20-23	2			2			
22-1	2			2			
22-8	2				2		
24-9	2		2				
32-5	2	2					
10SL3	3					3	
14S1	3					3	
14S7	3					3	
16S5	3					3	
16-7	3			1		2	
16-10	3				3		
18-5	3				2	1	
18-21	3				3		
18-22	3					3	
20-3	3				3		
20-6	3					3	
20-19	3				3		
22-2	3			3			
22-9	3				3		
22-21	3	1				2	
12SA10	4					4	
14S2	4					4	
16-9	4				2	2	
18-4	4					4	
18-10	4				4		
18-13	4			1	3		
20-4	4				4		
20-24	4			2		2	
22-4	4			2	2		
22-10	4					4	
22-22	4			4			
24-4	4	1				3	
24-22	4			4			
32-17	4		4				
36-5	4	4					

Contact arrangement	No. of Contacts	Contact size					
		0	4	8	12	16	20
		500	160	100	25	15	10
14S5	5					5	
16S8	5					5	
18-11	5				5		
18-20	5					5	
20-14	5			2	3		
22-12	5				2	3	
24-12	5		2		3		
28-5	5		2		1	2	
32-1	5	2			3		
14S6	6					6	
18-12	6					6	
20-8	6			2		4	
20-17	6				5	1	
20-22	6			3		3	
22-5	6				2	4	
22-15	6				5	1	
28-22	6		3			3	
36-3	6	3			3		
36-6	6	2	4				
14SA7	7					7	
16S1	7					7	
18-9	7				2	5	
18-17	7				2	5	
20-15	7				7		
22-28	7				7		
24-2	7				7		
24-10	7			7			
24-27	7					7	
28-10	7		2	2	3		
18-8	8				1	7	
20-7	8					8	
22-23	8				8		
32-15	8	2			6		
36A35	8	4				4	
24-6	8				8		
20-16	9				2	7	
20-18	9				3	6	
20A9	9				9		
22-16	9				3	6	
22-20	9					9	
22-27	9			1		8	
24-11	9			3	6		
28A16	9		4			5	
18-1	10					10	
18-19	10					10	

This document solely applies to European manufactured CA Threaded products
Dimensions shown in mm | Specifications and dimensions subject to change

Contact arrangement	No. of Contacts	Contact size					
		0	4	8	12	16	20
		500	160	100	25	15	10
20-33	11					11	
24-20	11				2	9	
24-19	12					12	
24A24	12				12		
28-9	12				6	6	
28-51	12				12		
20-11	13					13	
20-27	14					14	
22-19	14					14	
28-2	14				2	12	
28-20	14				10	4	
32-9	14		2			12	
24-5	16					16	
24-7	16				2	14	
36-14	16			5	5	6	
20-29	17					17	
20A48	19					19	
22-14	19					19	
28-16	20					20	
28-11	22				4	18	
32-6	23		2	3	2	16	
32-13	23				5	18	
24-28	24					24	
20A24	24						24
28-12	26					26	
36A46	27				27		
24A28	28					28	
28A63	28				9	19	
32-8	30				6	24	
36-9	31		1	2	14	14	
28-15	35					35	
32-7	35				7	28	
36-15	35					35	
28-21	37					37	
36A98	39			8		31	
28A51	43					43	

Contact arrangement	No. of Contacts	Contact size					
		0	4	8	12	16	20
		500	160	100	25	15	10
28A51	43					43	
32A47	47					47	
36-7	47				7	40	
36-8	47				1	46	
36-10	48					48	
36A34	52					52	
32A10	54					54	
32A55	55					55	
32A69	61					20	41
36A99	65					15	50

This document solely applies to European manufactured CA Threaded products
Dimensions shown in mm | Specifications and dimensions subject to change

MOUNTING HOLES

Shell size	CA Threaded				Mounting holes for connectors styles, complete receptacle range
	d1 H12		d2 H13	e	
	CA3100..., CA20...	CA3102..., CA02...			
10SL	16,0	16,4	3,4	18,2	
12S	19,1	16,4	3,4	20,6	
14S	22,3	19,7	3,4	23,0	
16S/16	25,5	22,9	3,4	24,6	
18	28,7	26,1	3,4	27,0	
20	31,8	29,5	3,4	29,4	
22	35,0	32,7	3,4	31,8	
24	38,2	36,0	3,9	34,9	
28	44,5	42,0	3,9	39,7	
32	50,9	48,3	4,5	44,5	
36	57,2	53,1	4,5	49,2	

HARNESSING

CA Threaded connectors are designed for single wire harnessing, if an individual wire sealing grommet is used. Wires have to conform to wire and insulation diameters with the data given in the following table:

Contact size		Crimp/solder contacts		Insulation Ø	
AWG	metric mm	AWG	metric mm ²	AWG	metric mm
–	10	–	0,75-1,0	–	1,45-2,5
16S/15S	16/15	16	0,75-1,5	1,6-2,8	1,60-2,8
12	25	12	2,5	2,9-3,5	2,9-3,5
–	60	–	6,0	–	3,5-4,9
8	100	8	10,0	4,2-5,8	5,5-6,5
4	160	4	16,0	6,2-9,0	7,1-9,0
0	500	0	50,0	10,5-13,0	10,5-13,0

WIRE STRIPPING

Either mechanical or hot stripping can be used. Prevent conductors or insulators damage. For solder contacts, conductors have to be pretinned.

Note: Do not twist conductors used with crimp contacts. Do not touch uninsulated conductors before crimping, twisting of conductors and grease or lubricants on the wires cause poor crimp quality.

Contact size		Stripping length mm
AWG	metric	
–	10	4,0 + 0,4
16S/15S	16/15	6,0 + 0,5
12	25	6,0 + 0,5
8	60/100	11,0 + 0,8 – 0,4
4	160	11,0 + 0,8 – 0,4
0	500	13,0 + 0,8 – 0,4

WIRING HINTS

Strip wires carefully. Do not damage conductors and insulation. For solder connections, wires have to be pretinned. Do not twist conductors used in crimp contacts, otherwise no perfect crimp connection will be achieved. Do not touch conductors before crimping. Film of grease or lubricants on the strands will cause poor crimp quality.

For detailed assembly instructions please visit www.ittcannon.com and search for the keyword "CA Bayonet Assembly Instruction".

SEPARATING AND COUPLING DIMENSIONS

PLUG

CA3106E

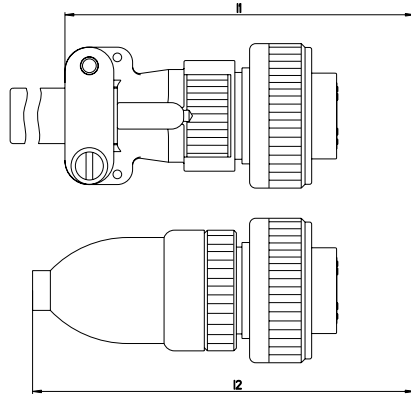

CA3106E-DN

RECEPTACLE

CA3102E

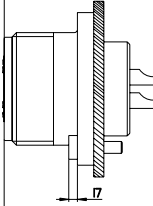

PLUG

CA3106F

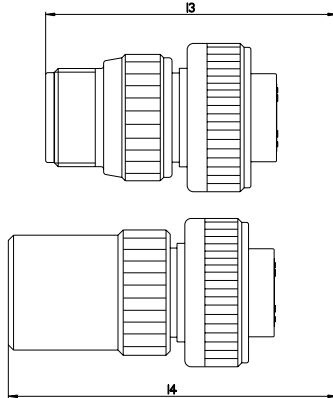

CA06PG/ME

RECEPTACLE

CA3102E

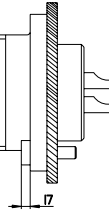

PLUG

CA3108E

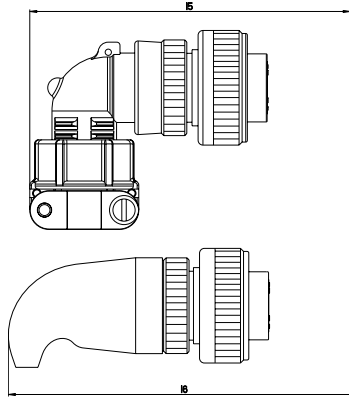

CA3106E-DN

RECEPTACLE

CA3102E

CA20L
CA20E

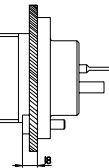

Shell size	I1 min.	I2 min.	I3 min.	I4 min.	I5 min.	I6 min.	I7 max.	I8 max.
10SL	70	70	65	80	70	65	3,5	8,0
12S	70	75	65	80	75	70	3,5	8,0
14S	70	75	65	80	75	80	3,5	8,0
16S	70	90	65	80	80	80	3,5	8,0
16	80	100	70	100	90	100	3,5	8,0
18	90	100	70	110	95	110	3,5	8,0
20	90	100	70	110	95	110	3,5	8,0
22	90	100	70	110	95	110	3,5	8,0
24	110	120	90	120	105	120	5,0	8,0
28	110	120	90	120	105	120	5,0	9,0
32	110	180	90	120	115	120	6,0	9,0
36	110	190	100	130	120	130	6,0	9,0

This document solely applies to European manufactured CA Threaded products
Dimensions shown in mm | Specifications and dimensions subject to change

WALL MOUNTING RECEPTACLE CLASS F, E

CA3100E

CA3100E designates a wall mounting receptacle. It mates with plugs CA3106 and CA3108. If crimp version is required please order CA3100E...F80 or CA3100E...F183.

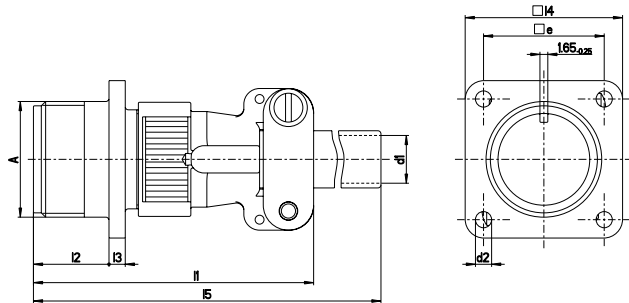

Part No. CA (pin insert*)	A Thread	I1 max.	I2 ±0,3	I3 max.	I4 +0,2/-0,1	I5 max.	d1 ¹	d2 +0,2	e ±0,3
CA3100E10SL-**p***	5/8-24UNEF-2A	53	14,2	2,8	25,4	120	6,5	3,1	18,2
CA3100E12S-**p***	3/4-20UNEF-2A	53	14,2	3,2	28,0	120	6,5	3,1	20,6
CA3100E14S-**p***	7/8-20UNEF-2A	55	14,2	3,2	30,0	120	9,0	3,1	23,0
CA3100E16S-**p***	1-20UNEF-2A	56	14,2	3,2	32,5	125	11,0	3,1	24,6
CA3100E16-**p***	1-20UNEF-2A	66	19,0	3,2	32,5	125	11,0	3,1	24,6
CA3100E18-**p***	1-1/8-18UNEF-2A	68	19,0	4,0	35,0	125	14,2	3,1	27,0
CA3100E20-**p***	1-1/4-18UNEF-2A	68	19,0	4,0	38,0	125	15,8	3,1	29,4
CA3100E22-**p***	1-3/8-18UNEF-2A	68	19,0	4,0	41,0	125	15,8	3,1	31,8
CA3100E24-**p***	1-1/2-18UNEF-2A	76	20,6	4,0	44,5	125	21,4	3,7	34,9
CA3100E28-**p***	1-3/4-18UNS-2A	76	20,6	4,0	50,8	125	21,4	3,7	39,7
CA3100E32-**p***	2-18UNS-2A	76	22,2	4,0	57,0	125	26,7	4,4	44,5
CA3100E36-**p***	2-1/4-16UN-2A	76	22,2	4,0	63,5	135	31,7	4,4	49,2

¹ max. cable dia

CA3100R

CA3100R designates a receptacle with a shorter and lightweight backshell. It mates with plugs CA3106 and CA3108. If crimp version is required please order CA3100R...F80 or CA3100R...F183.

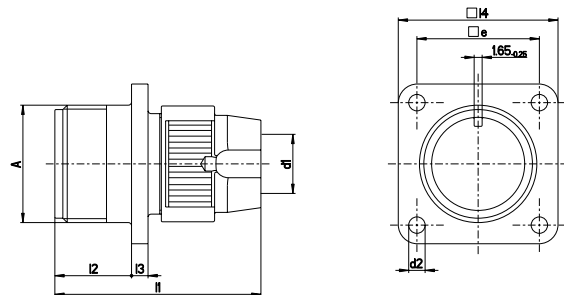

Part No. CA (pin insert*)	A Thread	I1 max.	I2 ±0,3	I3 max.	I4 ±0,2	d1 ¹	d2 ±0,2	e ±0,3
CA3100R10SL-**p***	5/8-24UNEF-2A	53	14,2	2,8	25,4	9,6	3,1	18,2
CA3100R12S-**p***	3/4-20UNEF-2A	53	14,2	3,2	28,0	10,3	3,1	20,6
CA3100R14S-**p***	7/8-20UNEF-2A	55	14,2	3,2	30,0	12,4	3,1	23,0
CA3100R16S-**p***	1-20UNEF-2A	56	14,2	3,2	32,5	15,4	3,1	24,6
CA3100R16-**p***	1-20UNEF-2A	66	19,0	3,2	32,5	15,4	3,1	24,6
CA3100R18-**p***	1-1/8-18UNEF-2A	68	19,0	4,0	35,0	18,4	3,1	27,0
CA3100R20-**p***	1-1/4-18UNEF-2A	68	19,0	4,0	38,0	22,0	3,1	29,4
CA3100R22-**p***	1-3/8-18UNEF-2A	68	19,0	4,0	41,0	24,7	3,1	31,8
CA3100R24-**p***	1-1/2-18UNEF-2A	76	20,6	4,0	44,5	27,6	3,7	34,9
CA3100R28-**p***	1-3/4-18UNS-2A	76	20,6	4,0	50,8	31,6	3,7	39,7
CA3100R32-**p***	2-18UNS-2A	76	22,2	4,0	57,0	38,5	4,4	44,5
CA3100R36-**p***	2-1/4-16UN-2A	76	22,2	4,0	63,5	44,5	4,4	49,2

*For socket inserts substitute "P" with "S" **Add contact arrangement number; see pages 9-21 *** Add modification code; see page 8

¹ max. cable dia

This document solely applies to European manufactured CA Threaded products
Dimensions shown in mm | Specifications and dimensions subject to change

CANNON CA THREADED

WALL MOUNTING RECEPTACLE CLASS F, DN

CA3100F

CA3100F designates a wall mounting receptacle with backshell for flex tubes or to be combined with a cable clamp. It mates with plugs CA3106 and CA3108.

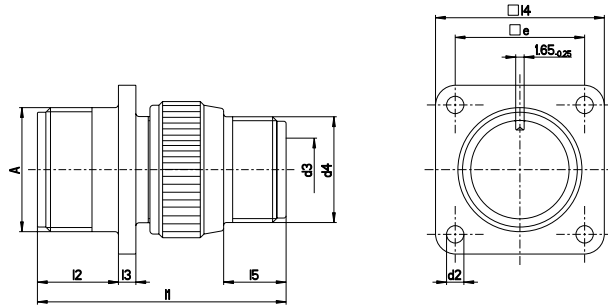

Part No. CA (pin insert*)	A Thread	d2 +0,2/-0,1	d3 ¹	d4 Thread	l1 max.	l2 +0,4	l3 ±0,3	l4 ±0,3	l5 min.	e ±0,1
CA3100F10SL-**P-***	5/8-24UNEF-2A	3,1	8,2	5/8-24UNEF-2A	45,0	14,2	2,8	25,4	9,5	18,2
CA3100F12S-**P-***	3/4-20UNEF-2A	3,1	8,2	5/8-20UNEF-2A	45,0	14,2	3,2	28,0	9,5	20,6
CA3100F14S-**P-***	7/8-20UNEF-2A	3,1	11,1	3/4-20UNEF-2A	45,0	14,2	3,2	30,0	9,5	23,0
CA3100F16S-**P-***	1-20UNEF-2A	3,1	14,3	7/8-20UNEF-2A	45,0	14,2	3,2	32,5	9,5	24,6
CA3100F16-**P-***	1-20UNEF-2A	3,1	14,3	7/8-20UNEF-2A	54,0	19,0	3,2	32,5	9,5	24,6
CA3100F18-**P-***	1-1/8-18UNEF-2A	3,1	16,7	1-20UNEF-2A	54,0	19,0	4,0	35,0	9,5	27,0
CA3100F20-**P-***	1-1/4-18UNEF-2A	3,1	19,8	1-3/16-18UNEF-2A	55,0	19,0	4,0	38,0	9,5	29,4
CA3100F22-**P-***	1-3/8-18UNEF-2A	3,1	19,8	1-3/16-18UNEF-2A	58,0	19,0	4,0	41,0	9,5	31,8
CA3100F24-**P-***	1-1/2-18UNEF-2A	3,7	25,4	1-7/16-18UNEF-2A	59,0	20,6	4,0	44,5	9,5	34,9
CA3100F28-**P-***	1-3/4-18UNS-2A	3,7	27,0	1-7/16-18UNEF-2A	60,0	20,6	4,0	50,8	9,5	39,7
CA3100F32-**P-***	2-18UNS-2A	4,4	32,5	1-3/4-18UNS-2A	62,0	22,2	4,0	57,0	11,0	44,5
CA3100F36-**P-***	2-1/4-16UN-2A	4,4	35,7	2-18UNS-2A	64,0	22,2	4,0	63,5	11,8	49,2

¹ max. cable dia

CA3100E-DN

CA3100E-DN designates a wall mounting receptacle with backshell for heat-shrinkable boots. It mates with plugs CA3106 and CA3108.

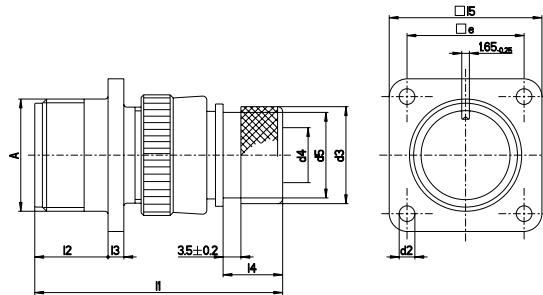

Part No. CA (pin insert*)	A Thread	d2 +0,2/-0,1	d3 ±0,2	d4 ¹	d5 max.	l1 max.	l2 +0,4	l3 ±0,3	l4 ±0,5	l5 ±0,3	e ±0,1
CA3100E10SL-**P-DN	5/8-24UNEF-2A	3,1	15,5	7,7	13,3	49,0	14,2	2,8	11,7	25,4	18,2
CA3100E12S-**P-DN	3/4-20UNEF-2A	3,1	15,5	7,9	13,3	49,0	14,2	3,2	11,7	28,0	20,6
CA3100E14S-**P-DN	7/8-20UNEF-2A	3,1	19,1	10,6	17,0	49,0	14,2	3,2	11,7	30,0	23,0
CA3100E16S-**P-DN	1-20UNEF-2A	3,1	23,9	13,5	21,9	49,0	14,2	3,2	11,7	32,5	24,6
CA3100E16-**P-DN	1-20UNEF-2A	3,1	23,9	13,5	21,9	58,0	19,0	3,2	11,5	32,5	24,6
CA3100E18-**P-DN	1-1/8-18UNEF-2A	3,1	23,9	14,6	21,9	58,0	19,0	4,0	11,5	35,0	27,0
CA3100E20-**P-DN	1-1/4-18UNEF-2A	3,1	29,6	18,7	26,2	60,0	19,0	4,0	12,7	35,0	27,0
CA3100E22-**P-DN	1-3/8-18UNEF-2A	3,1	29,6	20,8	26,2	60,0	19,0	4,0	12,7	41,0	31,8
CA3100E24-**P-DN	1-1/2-18UNEF-2A	3,7	37,8	24,6	34,5	63,0	20,6	4,0	12,7	44,5	34,9
CA3100E28-**P-DN	1-3/4-18UNS-2A	3,7	37,8	27,0	34,5	63,0	20,6	4,0	12,7	50,8	39,7
CA3100E32-**P-DN	2-18UNS-2A	4,4	47,8	33,3	43,6	67,0	22,2	4,0	15,2	57,0	44,5
CA3100E36-**P-DN	2-1/4-16UN-2A	4,4	47,8	38,5	43,6	68,0	22,2	4,0	15,2	63,5	49,2

*For socket inserts substitute "P" with "S" **Add contact arrangement number; see pages 10-22 *** Add modification code; see page 8

¹ max. cable dia

This document solely applies to European manufactured CA Threaded products
Dimensions shown in mm | Specifications and dimensions subject to change

WALL MOUNTING RECEPTACLE CLASS PG/ME, SHIELDED

CA00PG and CA00ME

CA00PG/ME designates a wall mounting receptacle for usage with PG or metric glands. It mates with plugs CA3106 and CA3108. The cable gland is not content of the delivery.

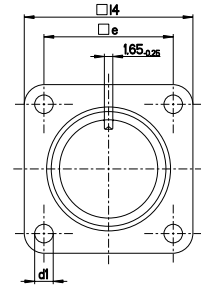
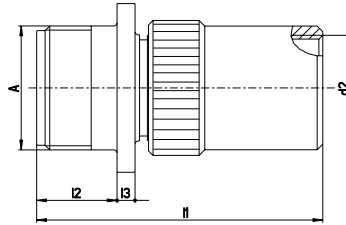

Part No. CA (pin insert*)	A Thread	d1 +0,2/-0,1	d2		l1 max.	l2 +0,4	l3 ±0,3	l4 ±0,3	e ±0,1
			PG-Thread	Metric					
CA00PG10SL-**P-*** CA00ME10SL-**P-***	5/8-24UNEF-2A	3,1	PG9	M16 × 1,5	52,0	14,2	2,8	25,4	18,2
CA00PG12S-**P-*** CA00ME12S-**P-***	3/4-20UNEF-2A	3,1	PG9	M16 × 1,5	52,0	14,2	3,2	28,0	20,6
CA00PG14S-**P-*** CA00ME14S-**P-***	7/8-20UNEF-2A	3,1	PG11	M20 × 1,5	52,0	14,2	3,2	30,0	23,0
CA00PG16S-**P-*** CA00ME16S-**P-***	1-20UNEF-2A	3,1	PG13,5	M20 × 1,5	54,0	14,2	3,2	32,5	24,6
CA00PG16-**P-*** CA00ME16-**P-***	1-20UNEF-2A	3,1	PG13,5	M20 × 1,5	64,0	19,0	3,2	32,5	24,6
CA00PG18-**P-*** CA00ME18-**P-***	1-1/8-18UNEF-2A	3,1	PG13,5	M25 × 1,5	69,0	19,0	4,0	35,0	27,0
CA00PG20-**P-*** CA00ME20-**P-***	1-1/4-18UNEF-2A	3,1	PG16	M25 × 1,5	70,0	19,0	4,0	38,0	29,4
CA00PG22-**P-*** CA00ME22-**P-***	1-3/8-18UNEF-2A	3,1	PG16	M32 × 1,5	73,0	19,0	4,0	41,0	31,8
CA00PG24-**P-*** CA00ME24-**P-***	1-1/2-18UNEF-2A	3,7	PG16	M32 × 1,5	74,0	20,6	4,0	44,5	34,9
CA00PG28-**P-*** CA00ME28-**P-***	1-3/4-18UNS-2A	3,7	PG21	M32 × 1,5	74,0	20,6	4,0	50,8	39,7
CA00PG32-**P-*** CA00ME32-**P-***	2-18UNS-2A	4,4	PG29	M40 × 1,5	76,0	22,2	4,0	57,0	44,5
CA00PG36-**P-*** CA00ME36-**P-***	2-1/4-16UN-2A	4,4	PG29	M40 × 1,5	87,0	22,2	4,0	63,5	49,2

CA3100E...-13/-14/-15

CA3100E...-13/-14/-15 designates a shielded wall mounting receptacle with backshell to accommodate cable braids and heat-shrinkable boots. For Mod. codes please see page 8. It mates with plugs CA3106...-13/-14/-15.

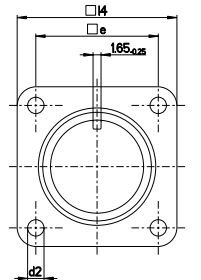
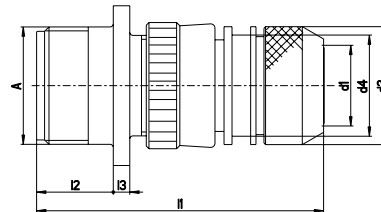

Part No. CA (pin insert*)	A Thread	d1 ¹	d2 +0,2/-0,1	d3 ±0,5	d4 max.	l1 max.	l2 +0,4	l3 ±0,3	l4 ±0,5	e ±0,1
CA3100E12S-**P-***	3/4-20UNEF-2A	7,9	3,1	20,0	17,0	55,0	14,2	3,2	28,0	20,6
CA3100E14S-**P-***	7/8-20UNEF-2A	10,6	3,1	22,0	20,0	58,0	14,2	3,2	30,0	23,0
CA3100E16S-**P-***	1-20UNEF-2A	13,5	3,1	25,0	23,0	70,0	14,2	3,2	32,5	24,6
CA3100E16-**P-***	1-20UNEF-2A	13,5	3,1	25,0	23,0	70,0	19,0	3,2	32,5	24,6
CA3100E18-**P-***	1-1/8-18UNEF-2A	14,6	3,1	28,0	24,5	70,0	19,0	4,0	35,0	27,0
CA3100E20-**P-***	1-1/4-18UNEF-2A	18,5	3,1	32,0	28,5	70,0	19,0	4,0	38,0	27,0
CA3100E22-**P-***	1-3/8-18UNEF-2A	20,8	3,1	34,0	30,5	70,0	19,0	4,0	41,0	31,8
CA3100E24-**P-***	1-1/2-18UNEF-2A	24,6	3,7	38,0	34,5	70,0	20,6	4,0	44,5	34,9
CA3100E28-**P-***	1-3/4-18UNS-2A	27,0	3,7	41,0	37,5	70,0	20,6	4,0	50,8	39,7
CA3100E32-**P-***	2-18UNS-2A	33,3	4,4	48,0	44,0	75,0	22,2	4,0	57,0	44,5
CA3100E36-**P-***	2-1/4-16UN-2A	38,5	4,4	55,0	51,0	85,0	22,2	4,0	63,5	49,2

*For socket inserts substitute "P" with "S" **Add contact arrangement number; see pages 10-22 *** Add modification code; see page 8

¹ max. cable dia

This document solely applies to European manufactured CA Threaded products
Dimensions shown in mm | Specifications and dimensions subject to change

CANNON CA THREADED

CABLE CONNECTING PLUG CLASS F, E, R

CA3101E

CA3101E designates a cable connecting plug (without flange and coupling nut). It mates with plugs CA3106 and CA3108.

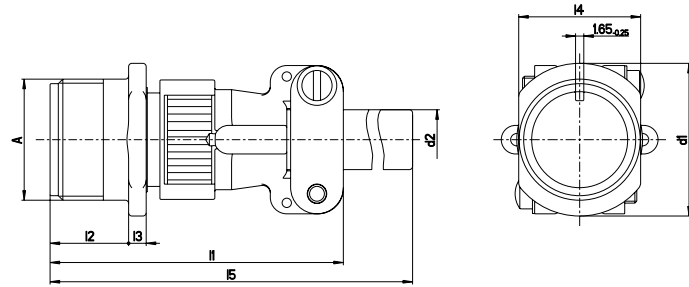

Part No. CA (pin insert*)	A Thread	d1 max.	d2 ¹	I1 max.	I2 +0,4	I3 ±0,3	I4 max.	I5 max.
CA3101E10SL-**p***	5/8-24UNEF-2A	21,8	6,5	53,0	14,2	2,8	16,2	120
CA3101E12S-**p***	3/4-20UNEF-2A	25,0	6,5	53,0	14,2	3,2	19,4	120
CA3101E14S-**p***	7/8-20UNEF-2A	28,2	9,0	55,0	14,2	3,2	22,5	120
CA3101E16S-**p***	1-20UNEF-2A	31,4	11,0	56,0	14,2	3,2	25,7	120
CA3101E16-**p***	1-20UNEF-2A	31,4	11,0	66,0	19,0	3,2	25,7	125
CA3101E18-**p***	1-1/8-18UNEF-2A	34,5	14,2	68,0	19,0	4,0	28,9	125
CA3101E20-**p***	1-1/4-18UNEF-2A	37,3	15,8	68,0	19,0	4,0	32,1	125
CA3101E22-**p***	1-3/8-18UNEF-2A	40,9	15,8	68,0	19,0	4,0	35,2	125
CA3101E24-**p***	1-1/2-18UNEF-2A	43,8	21,4	76,0	20,6	4,0	38,4	125
CA3101E28-**p***	1-3/4-18UNS-2A	50,4	21,4	76,0	20,6	4,0	44,8	125
CA3101E32-**p***	2-18UNS-2A	56,8	26,7	76,0	22,2	4,0	51,1	125
CA3101E36-**p***	2-1/4-16UN-2A	63,1	31,7	76,0	22,2	4,0	57,5	135

¹ max. cable dia

CA3101R

CA3101R designates a cable connecting plug (without flange and coupling nut) with a shorter and lightweight backshell. It mates with plugs CA3106 and CA3108. Utilized to realize a cable to cable connection. If crimp version is required please order CA3101R...F80 or CA3101R...F183

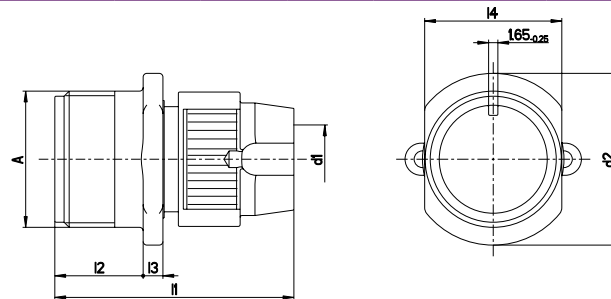

Part No. CA (pin insert*)	A Thread	d1 ¹	I1 max.	I2 + 0,4	I3 ± 0,3	I4 ± 0,2
CA3101R10SL-**p***	5/8-24UNEF-2A	9,6	53,0	14,2	2,8	16,2
CA3101R12S-**p***	3/4-20UNEF-2A	10,3	53,0	14,2	3,2	19,4
CA3101R14S-**p***	7/8-20UNEF-2A	12,4	55,0	14,2	3,2	22,5
CA3101R16S-**p***	1-20UNEF-2A	15,4	56,0	14,2	3,2	25,7
CA3101R16-**p***	1-20UNEF-2A	15,4	66,0	19,0	3,2	25,7
CA3101R18-**p***	1-1/8-18UNEF-2A	18,4	68,0	19,0	4,0	28,9
CA3101R20-**p***	1-1/4-18UNEF-2A	22,0	68,0	19,0	4,0	32,1
CA3101R22-**p***	1-3/8-18UNEF-2A	24,7	68,0	19,0	4,0	35,2
CA3101R24-**p***	1-1/2-18UNEF-2A	27,6	76,0	20,6	4,0	38,4
CA3101R28-**p***	1-3/4-18UNS-2A	31,6	76,0	20,6	4,0	44,8
CA3101R32-**p***	2-18UNS-2A	38,5	76,0	22,2	4,0	51,1
CA3101R36-**p***	2-1/4-16UN-2A	44,5	76,0	22,2	4,0	57,5

*For socket inserts substitute "P" with "S" **Add contact arrangement number; see pages 10-22 ***Add modification code; see page 8

¹ max. cable dia

This document solely applies to European manufactured CA Threaded products
Dimensions shown in mm | Specifications and dimensions subject to change

CABLE CONNECTING PLUG CLASS F, DN

CA3101F

CA3101F designates a cable connecting plug (without flange and coupling nut) with backshell for flex tubes or to be combined with a cable clamp. It mates with plugs CA3106 and CA3108. Utilized to realize a cable to cable connection. If crimp version is required please order CA3101F...F80 or CA3101F...F183

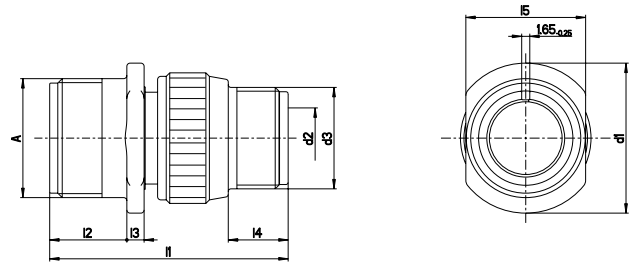

Part No. CA (pin insert*)	A Thread	d1 max.	d2 ¹	d3 Thread	L1 max.	L2 +0,4	L3 ±0,3	L4 min.	L5 ±0,2
CA3101F10SL**P***	5/8-24UNEF-2A	21,8	8,2	5/8-24UNEF-2A	45,0	14,2	2,8	9,5	16,2
CA3101F12S**P***	3/4-20UNEF-2A	25,0	8,2	5/8-20UNEF-2A	45,0	14,2	3,2	9,5	19,4
CA3101F14S**P***	7/8-20UNEF-2A	28,2	11,1	3/4-20UNEF-2A	45,0	14,2	3,2	9,5	22,5
CA3101F16S**P***	1-20UNEF-2A	31,4	14,3	7/8-20UNEF-2A	45,0	14,2	3,2	9,5	25,7
CA3101F16**P***	1-20UNEF-2A	31,4	14,3	7/8-20UNEF-2A	54,0	14,2	3,2	9,5	25,7
CA3101F18**P***	1-1/8-18UNEF-2A	34,5	16,7	1-20UNEF-2A	54,0	19,0	4,0	9,5	28,9
CA3101F20**P***	1-1/4-18UNEF-2A	37,3	19,8	1-3/16-18UNEF-2A	55,0	19,0	4,0	9,5	32,1
CA3101F22**P***	1-3/8-18UNEF-2A	40,9	19,8	1-3/16-18UNEF-2A	58,0	20,6	4,0	9,5	35,2
CA3101F24**P***	1-1/2-18UNEF-2A	43,8	25,4	1-7/16-18UNEF-2A	59,0	20,6	4,0	9,5	38,4
CA3101F28**P***	1-3/4-18UNS-2A	50,4	27,0	1-7/16-18UNEF-2A	60,0	20,6	4,0	9,5	44,8
CA3101F32**P***	2-18UNS-2A	56,8	32,5	1-3/4-18UNS-2A	62,0	22,2	4,0	11,0	51,1
CA3101F36**P***	2-1/4-16UN-2A	63,1	35,7	2-18UNS-2A	64,0	22,2	4,0	11,8	57,5

¹ max. cable dia

CA3101E-DN

CA3101E-DN designates a cable connecting plug (without flange and coupling nut) with backshell for heat-shrinkable boots. It mates with plugs CA3106 and CA3108. Utilized to realize a cable to cable connection. If crimp version is required please order CA3101E-DN-F80 or CA3101E-DN-F183

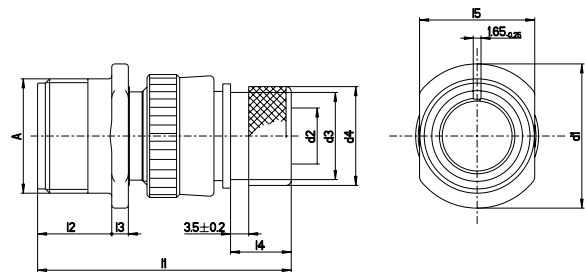

Part No. CA (pin insert*)	A Thread	d1 max.	d2 ¹	d3 ±0,5	d4 ±0,2	I1 max.	I2 ±0,3	I3 ±0,3	I4 max.	I5 ±0,2
CA3101E10SL**P-DN	5/8-24UNEF-2A	21,8	7,7	15,5	7,7	49,0	14,2	2,8	11,7	16,2
CA3101E12S**P-DN	3/4-20UNEF-2A	25,0	7,9	15,5	7,9	49,0	14,2	3,2	11,7	19,4
CA3101E14S**P-DN	7/8-20UNEF-2A	28,2	10,6	19,1	10,6	49,0	14,2	3,2	11,7	22,5
CA3101E16S**P-DN	1-20UNEF-2A	31,4	13,5	23,9	13,5	49,0	14,1	3,2	11,7	25,7
CA3101E16**P-DN	1-20UNEF-2A	31,4	13,5	23,9	13,5	58,0	19,0	3,2	11,5	25,7
CA3101E18**P-DN	1-1/8-18UNEF-2A	34,5	14,6	23,9	14,6	58,0	19,0	4,0	11,5	28,9
CA3101E20**P-DN	1-1/4-18UNEF-2A	37,3	18,7	29,6	18,7	60,0	19,0	4,0	12,7	32,1
CA3101E22**P-DN	1-3/8-18UNEF-2A	40,9	20,8	29,6	20,8	60,0	19,0	4,0	12,7	35,2
CA3101E24**P-DN	1-1/2-18UNEF-2A	43,8	24,6	37,8	24,6	63,0	20,6	4,0	12,7	38,4
CA3101E28**P-DN	1-3/4-18UNS-2A	50,4	27,0	37,8	27,0	63,0	20,6	4,0	12,7	44,8
CA3101E32**P-DN	2-18UNS-2A	56,8	33,3	47,8	33,3	67,0	22,2	4,0	15,2	51,1
CA3101E36**P-DN	2-1/4-16UN-2A	63,1	38,5	47,8	38,5	68,0	22,2	4,0	15,2	57,5

* For socket inserts substitute "P" with "S" **Add contact arrangement number; see pages 10-22 *** Add modification code; see page 8

¹ max. cable dia

This document solely applies to European manufactured CA Threaded products
Dimensions shown in mm | Specifications and dimensions subject to change



CANNON CA THREADED

CABLE CONNECTING PLUG PG/ME, SHIELDED

CA01PG and CA01ME

CA01PG/ME designates a cable connecting plug (without flange and coupling nut) for usage with PG or metric glands. It mates with plugs CA3106 and CA3108. The cable gland is not content of the delivery.

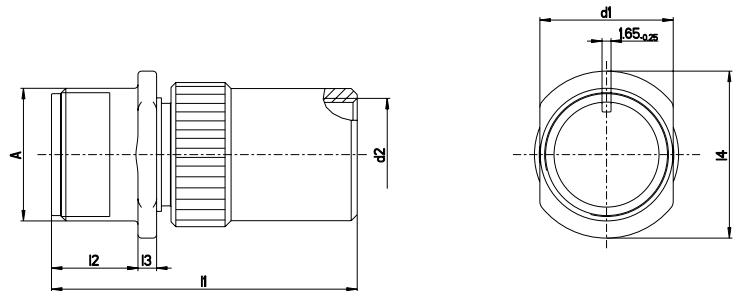

Part No. CA (pin insert*)	A Thread	d1 max.	d2 PG-Thread	Metric	d4 max.	I2 +0,4	I3 ±0,3	I4 max.
CA01PG10SL-**P-*** CA01ME10SL-**P-***	5/8-24UNEF-2A	16,2	PG9	M16 × 1,5	52,0	14,2	2,8	21,8
CA01PG12S-**P-*** CA01ME12S-**P-***	3/4-20UNEF-2A	19,4	PG9	M16 × 1,5	52,0	14,2	3,2	25,0
CA01PG14S-**P-*** CA01ME14S-**P-***	7/8-20UNEF-2A	22,5	PG11	M20 × 1,5	52,0	14,2	3,2	28,2
CA01PG16S-**P-*** CA01ME16S-**P-***	1-20UNEF-2A	25,7	PG13,5	M20 × 1,5	54,0	14,2	3,2	31,4
CA01PG16-***P-*** CA01ME16-***P-***	1-20UNEF-2A	25,7	PG13,5	M20 × 1,5	64,0	19,0	3,2	31,4
CA01PG18-***P-*** CA01ME18-***P-***	1-1/8-18UNEF-2A	28,9	PG13,5	M25 × 1,5	69,0	19,0	4,0	34,5
CA01PG20-***P-*** CA01ME20-***P-***	1-1/4-18UNEF-2A	32,1	PG16	M25 × 1,5	70,0	19,0	4,0	37,3
CA01PG22-***P-*** CA01ME22-***P-***	1-3/8-18UNEF-2A	35,2	PG16	M32 × 1,5	73,0	19,0	4,0	40,9
CA01PG24-***P-*** CA01ME24-***P-***	1-1/2-18UNEF-2A	38,4	PG16	M32 × 1,5	74,0	20,6	4,0	43,8
CA01PG28-***P-*** CA01ME28-***P-***	1-3/4-18UNS-2A	44,8	PG21	M32 × 1,5	74,0	20,6	4,0	50,4
CA01PG32-***P-*** CA01ME32-***P-***	2-18UNS-2A	51,1	PG29	M40 × 1,5	76,0	22,2	4,0	56,8
CA01PG36-***P-*** CA01ME36-***P-***	2-1/4-16UN-2A	57,5	PG29	M40 × 1,5	87,0	22,2	4,0	63,1

CA3101E...-13/-14/-15

CA3101E...-13/-14/-15 designates a shielded cable connecting plug (without flange and coupling nut) to accommodate cable braids and heat-shrinkable boots. For Mod. codes please see page 8. It mates with plugs CA3106...-13/-14/-15. Utilized to realize a cable to cable connection.

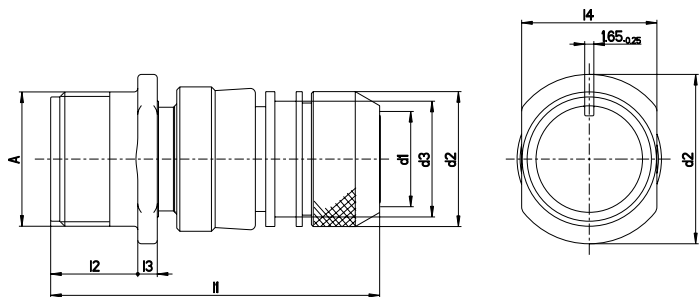

Part No. CA (pin insert*)	A Thread	d1 ¹	d2 ±0,5	d3 max.	I1 max.	I2 ±0,3	I3 ±0,3	I4 max.
CA3101E10SL-**P-***	5/8-24UNEF-2A	7,7	18,5	16,3	55,0	14,2	2,8	16,2
CA3101E12S-**P-***	3/4-20UNEF-2A	7,9	20,0	17,0	55,0	14,2	3,2	19,4
CA3101E14S-**P-***	7/8-20UNEF-2A	10,6	22,0	20,0	58,0	14,2	3,2	22,5
CA3101E16S-**P-***	1-20UNEF-2A	13,5	25,0	23,0	70,0	14,1	3,2	25,7
CA3101E16-***P-***	1-20UNEF-2A	13,5	25,0	23,0	70,0	19,0	3,2	25,7
CA3101E18-***P-***	1-1/8-18UNEF-2A	14,6	28,0	24,5	70,0	19,0	4,0	28,9
CA3101E20-***P-***	1-1/4-18UNEF-2A	14,6	32,0	28,5	70,0	19,0	4,0	32,1
CA3101E22-***P-***	1-3/8-18UNEF-2A	20,8	34,0	30,5	70,0	19,0	4,0	35,2
CA3101E24-***P-***	1-1/2-18UNEF-2A	24,6	38,0	34,5	70,0	20,6	4,0	38,4
CA3101E28-***P-***	1-3/4-18UNS-2A	27,0	41,0	37,5	70,0	20,6	4,0	44,8
CA3101E32-***P-***	2-18UNS-2A	33,3	48,0	44,0	75,0	22,2	4,0	51,1
CA3101E36-***P-***	2-1/4-16UN-2A	38,5	55,0	51,0	85,0	22,2	4,0	57,5

*For socket inserts substitute "P" with "S" **Add contact arrangement number; see pages 10-22 ***Add modification code; see page 8

¹ max. cable dia

This document solely applies to European manufactured CA Threaded products
Dimensions shown in mm | Specifications and dimensions subject to change

BOX MOUNTING RECEPTACLE

CA3102

CA3102E designates a box mounting receptacle for front panel mounting with square flange. It mates with plugs CA3106 and CA3108.
If crimp version is required please order CA3102E...F80 or CA3102E...F183.

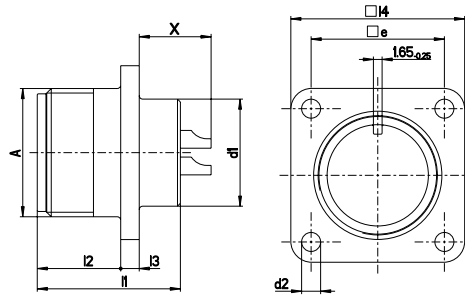

Shell size	Contact size			
	16	12	8	4 0
10SL	13,6	-	-	-
12S,14S,16S	13,2	-	-	-
12	17,9	17,9	-	-
14	17,9	17,9	19,5	-
16	17,9	17,9	19,5	19,5
18	17,1	17,1	18,7	18,7
20, 22	17,1	17,1	18,7	18,7
24, 28	15,5	15,5	17,1	17,1
32, 36	13,9	13,9	15,5	15,5

Part No. CA (pin insert*)	A Thread	I1 max.	I2 +0,4	I3 ±0,7	I4 ±0,3	d1 max.	d2 +0,2/-0,1	e ±0,1
CA3102E10SL-***p***	5/8-24UNEF-2A	25,1	14,2	3,0	25,4	15,9	3,1	18,2
CA3102E12S-***p***	3/4-20UNEF-2A	25,1	14,2	3,0	28,0	15,9	3,1	20,6
CA3102E14S-***p***	7/8-20UNEF-2A	25,1	14,2	3,0	30,0	19,0	3,1	23,0
CA3102E16S-***p***	1-20UNEF-2A	25,1	14,2	3,0	32,5	22,2	3,1	24,6
CA3102E16-***p***	1-20UNEF-2A	34,6	19,0	3,0	32,5	22,2	3,1	24,6
CA3102E18-***p***	1-1/8-18UNEF-2A	34,6	19,0	3,9	35,0	25,4	3,1	27,0
CA3102E20-***p***	1-1/4-18UNEF-2A	34,6	19,0	3,9	38,0	29,0	3,1	29,4
CA3102E22-***p***	1-3/8-18UNEF-2A	34,6	19,0	3,9	41,0	32,2	3,1	31,8
CA3102E24-***p***	1-1/2-18UNEF-2A	36,2	20,6	3,9	44,5	35,3	3,7	34,9
CA3102E28-***p***	1-3/4-18UNS-2A	36,2	20,6	3,9	50,8	41,2	3,7	39,7
CA3102E32-***p***	2-18UNS-2A	37,8	22,2	3,9	57,0	47,6	4,4	44,5
CA3102E36-***p***	2-1/4-16UN-2A	37,8	22,2	3,9	63,5	52,4	4,4	49,2

Note: Older versions also used the designation CA3102R instead of the CA3102E. These parts would be identical but the designation is no longer valid.

CA20E

CA20E designates a box mounting receptacle for rear panel mounting. It mates with plugs CA3106 and CA3108.

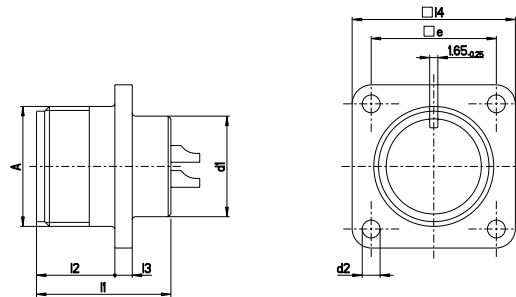

Part No. CA (pin insert*)	A Thread	d1 max.	d2		I1 max.	I2 +0,4	I3 ±0,3	I4 ±0,3	e ±0,1
			H13	Code: BM29					
CA20E10SL-**-p-***	5/8-24UNEF-2A	14,5	3,2	M4	25,1	18,2	2,8	25,4	18,2
CA20E12S-**-p-***	3/4-20UNEF-2A	16,1	3,2	M4	25,1	18,2	3,2	28,0	20,6
CA20E14S-**-p-***	7/8-20UNEF-2A	19,2	3,2	M4	25,1	18,2	3,2	30,0	23,0
CA20E16S-**-p-***	1-20UNEF-2A	22,4	3,2	M4	25,1	18,2	3,2	32,5	24,6
CA20E16-**-p-***	1-20UNEF-2A	22,4	3,2	M4	34,2	21,5	3,2	32,5	24,6
CA20E18-**-p-***	1-1/8-18UNEF-2A	25,6	3,2	M4	34,2	23,05	4,0	35,0	27,0
CA20E20-**-p-***	1-1/4-18UNEF-2A	29,0	3,2	M4	34,2	23,05	4,0	38,0	29,4
CA20E22-**-p-***	1-3/8-18UNEF-2A	32,2	3,2	M4	34,2	23,05	4,0	41,0	31,8
CA20E24-**-p-***	1-1/2-18UNEF-2A	35,3	3,7	M5	34,2	24,05	4,0	44,5	34,9
CA20E28-**-p-***	1-3/4-18UNS-2A	41,4	3,7	M5	34,2	24,05	4,0	50,8	39,7
CA20E32-**-p-***	2-18UNS-2A	47,8	4,4	M6	34,2	24,05	4,0	57,0	44,5
CA20E36-**-p-***	2-1/4-16UN-2A	54,1	4,4	M6	34,2	24,05	4,0	63,5	49,2

*For socket inserts substitute "P" with "S" **Add contact arrangement number; see pages 10-22 ***Add modification code; see page 8

BOX MOUNTING RECEPTACLE PCB VERSION

CA02L

CA02L designates a box mounting receptacle for front panel mounting with PCB termination. It mates with plugs CA3106 and CA3108. Available for contact arrangements with #16 contacts only. For #12 contacts consult factory.

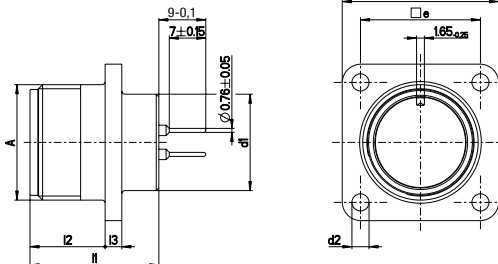

Part No. CA (pin insert*)	A Thread	d1 max.	d2 +0,2/-0,1	l1 max.	l2 +0,4	l3 0,3	l4 0,3	e 0,1
CA02L10SL-**-p-***	5/8-24UNEF-2A	15,9	3,1	25,1	14,2	2,8	25,4	18,2
CA02L12S-**-p-***	3/4-20UNEF-2A	15,9	3,1	25,1	14,2	3,2	28,0	20,6
CA02L14S-**-p-***	7/8-20UNEF-2A	19,0	3,1	25,1	14,2	3,2	30,0	23,0
CA02L16S-**-p-***	1-20UNEF-2A	22,2	3,1	25,1	14,2	3,2	32,5	24,6
CA02L16-**-p-***	1-20UNEF-2A	22,2	3,1	34,2	19,0	3,2	32,5	24,6
CA02L18-**-p-***	1-1/8-18UNEF-2A	25,4	3,1	34,2	19,0	4,0	35,0	27,0
CA02L20-**-p-***	1-1/4-18UNEF-2A	29,0	3,1	34,2	19,0	4,0	38,0	29,4
CA02L22-**-p-***	1-3/8-18UNEF-2A	32,2	3,1	34,2	19,0	4,0	41,0	31,8
CA02L24-**-p-***	1-1/2-18UNEF-2A	35,3	3,7	34,2	20,6	4,0	44,5	34,9
CA02L28-**-p-***	1-3/4-18UNS-2A	41,2	3,7	34,2	20,6	4,0	50,8	39,7
CA02L32-**-p-***	2-18UNS-2A	47,6	4,4	34,2	22,2	4,0	57,0	44,5
CA02L36-**-p-***	2-1/4-16UN-2A	52,4	4,4	34,2	22,2	4,0	63,5	49,2

CA20L

CA20L designates a box mounting receptacle for rear panel mounting with PCB termination. It mates with plugs CA3106 and CA3108. Available for contact arrangements with #16 contacts only. For #12 contacts consult factory.

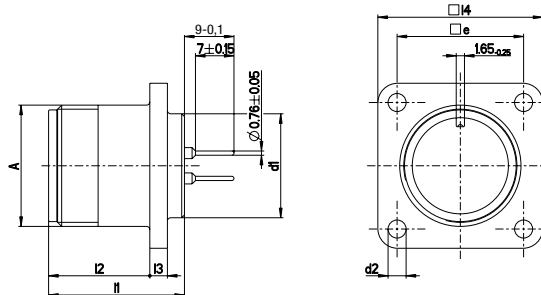

Part No. CA (pin insert*)	A Thread	d1 max.	d2		l1 max.	l2 0,4	l3 ±0,3	l4 ±0,3	e ±0,1
			H13 (Std.)	Code BM29					
CA20L10SL-**-p-***	5/8-24UNEF-2A	14,5	3,2	M4	25,1	18,2	2,8	25,4	18,2
CA20L12S-**-p-***	3/4-20UNEF-2A	16,1	3,2	M4	25,1	18,2	3,2	28,0	20,6
CA20L14S-**-p-***	7/8-20UNEF-2A	19,2	3,2	M4	25,1	18,2	3,2	30,0	23,0
CA20L16S-**-p-***	1-20UNEF-2A	22,4	3,2	M4	25,1	18,2	3,2	32,5	24,6
CA20L16-**-p-***	1-20UNEF-2A	22,4	3,2	M4	34,2	21,5	3,2	32,5	24,6
CA20L18-**-p-***	1-1/8-18UNEF-2A	25,6	3,2	M4	34,2	23,05	4,0	35,0	27,0
CA20L20-**-p-***	1-1/4-18UNEF-2A	29,0	3,2	M4	34,2	23,05	4,0	38,0	29,4
CA20L22-**-p-***	1-3/8-18UNEF-2A	32,2	3,2	M4	34,2	23,05	4,0	41,0	31,8
CA20L24-**-p-***	1-1/2-18UNEF-2A	35,3	3,7	M5	34,2	24,05	4,0	44,5	34,9
CA20L28-**-p-***	1-3/4-18UNS-2A	41,4	3,7	M5	34,2	24,05	4,0	50,8	39,7
CA20L32-**-p-***	2-18UNS-2A	47,8	4,4	M6	34,2	24,05	4,0	57,0	44,5
CA20L36-**-p-***	2-1/4-16UN-2A	54,1	4,4	M6	34,2	24,05	4,0	63,5	49,2

*For socket inserts substitute "P" with "S" **Add contact arrangement number; see pages 10-22 *** Add modification code; see page 8

This document solely applies to European manufactured CA Threaded products
Dimensions shown in mm | Specifications and dimensions subject to change

STRAIGHT PLUG GENERAL DUTY CLASS E, R

CA06R/CA3106E

CA06R and CA3106E are straight plugs. They mate with 3100, 3102, CA02L, CA20E, CA20L receptacles and 3101 plugs. If crimp version is required please order CA3106E...F80/F183 (without O-ring) or CA06R...F80/F183 (with O-ring).

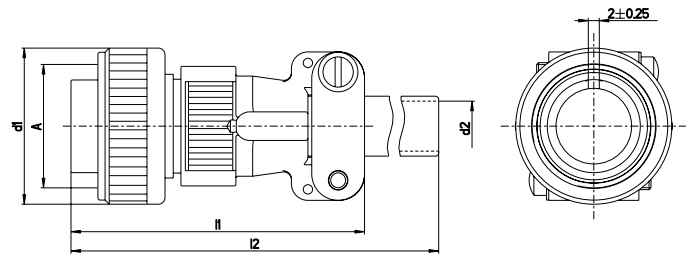

Part No. CA (pin insert*)	A Thread	d1 max.	d2 ¹	l1 max.	l2 max.
CA06R10SL-***p***	5/8-24UNEF-2B	24,1	6,5	53,0	115,0
CA06R12S-***p***	3/4-20UNEF-2B	25,8	6,5	53,0	115,0
CA06R14S-***p***	7/8-20UNEF-2B	28,8	9,0	55,0	115,0
CA06R16S-***p***	1-20UNEF-2B	31,8	11,0	56,0	115,0
CA06R16-***p***	1-20UNEF-2B	31,8	11,0	66,0	120,0
CA06R18-***p***	1-1/8-18UNEF-2B	34,1	14,2	68,0	120,0
CA06R20-***p***	1-1/4-18UNEF-2B	37,4	15,8	68,0	120,0
CA06R22-***p***	1-3/8-18UNEF-2B	40,5	15,8	68,0	120,0
CA06R24-***p***	1-1/2-18UNEF-2B	43,8	21,4	76,0	120,0
CA06R28-***p***	1-3/4-18UNS-2B	50,2	21,4	76,0	120,0
CA06R32-***p***	2-18UNS-2B	56,4	26,7	76,0	120,0
CA06R36-***p***	2-1/4-16UN-2B	62,8	31,7	76,0	130,0

¹ max. cable dia

CA3106R

The CA3106R straight plug has a shorter lightweight backshell than CA3106E. It contains an O-ring seal under the coupling nut.

CA3106R plugs mate with 3100, 3102, CA02L, CA20E, CA20L receptacles and 3101 plugs. If crimp version is required please order CA3106R...F80, CA3106R...F183.

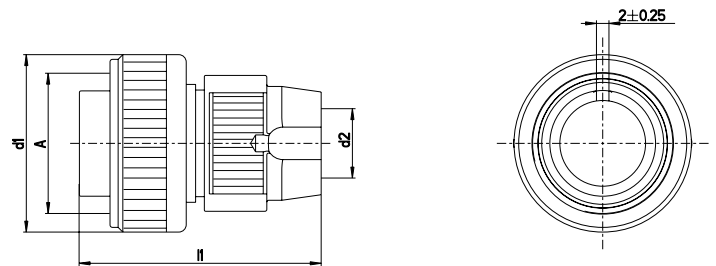

Part No. CA (pin insert*)	A Thread	d1 max.	d2 ¹	l1 max.
CA3106R10SL-***p***	5/8-24UNEF-2B	24,1	9,6	53,0
CA3106R12S-***p***	3/4-20UNEF-2B	25,8	10,3	53,0
CA3106R14S-***p***	7/8-20UNEF-2B	28,8	12,4	55,0
CA3106R16S-***p***	1-20UNEF-2B	31,8	15,4	56,0
CA3106R16-***p***	1-20UNEF-2B	31,8	15,4	66,0
CA3106R18-***p***	1-1/8-18UNEF-2B	34,1	18,4	68,0
CA3106R20-***p***	1-1/4-18UNEF-2B	37,4	22,0	68,0
CA3106R22-***p***	1-3/8-18UNEF-2B	40,5	24,7	68,0
CA3106R24-***p***	1-1/2-18UNEF-2B	43,8	27,6	76,0
CA3106R28-***p***	1-3/4-18UNS-2B	50,2	31,6	76,0
CA3106R32-***p***	2-18UNS-2B	56,4	38,5	76,0
CA3106R36-***p***	2-1/4-16UN-2B	62,8	44,5	76,0

*For socket inserts substitute "P" with "S" **Add contact arrangement number; see pages 10-22 *** Add modification code; see page 8

¹ max. cable dia

CANNON CA THREADED

STRAIGHT PLUG CLASS F, DN

CA3106F

CA3106F designates a straight plug with backshell for flex tubes or to be combined with a cable clamp. It mates with receptacles 3100, 3102, CA02L, CA20E, CA20L and 3101 plugs.

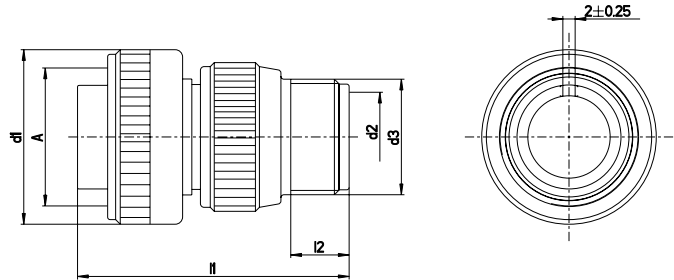

Part No. CA (pin insert*)	A Thread	d1 max.	d2 ¹	d3 Thread	l1 max.	l2 min.	
CA3106F10SL-**P	5/8-24UNEF-2B	24,1	8,2	5/8-24UNEF-2A	45,0	9,5	
CA3106F12S-**P	3/4-20UNEF-2B	25,8	8,2	5/8-20UNEF-2A	45,0	9,5	
CA3106F14S-**P	7/8-20UNEF-2B	28,8	11,1	3/4-20UNEF-2A	45,0	9,5	
CA3106F16S-**P	1-20UNEF-2B	31,8	14,3	7/8-20UNEF-2A	45,0	9,5	
CA3106F16-**P	1-20UNEF-2B	31,8	14,3	7/8-20UNEF-2A	54,0	9,5	
CA3106F18-**P	1-1/8-18UNEF-2B	34,1	16,7	1-20UNEF-2A	54,0	9,5	
CA3106F20-**P	1-1/4-18UNEF-2B	37,4	19,8	1-3/16-18UNEF-2A	55,0	9,5	
CA3106F22-**P	1-3/8-18UNEF-2B	40,5	19,8	1-3/16-18UNEF-2A	58,0	9,5	
CA3106F24-**P	1-1/2-18UNEF-2B	43,8	25,4	1-7/16-18UNEF-2A	59,0	9,5	
CA3106F28-**P	1-3/4-18UNS-2B	50,2	27,0	1-7/16-18UNEF-2A	60,0	9,5	
CA3106F32-**P	2-18UNS-2B	56,4	32,5	1-3/4-18UNS-2A	62,0	11,0	
CA3106F36-**P	2-1/4-16UN-2B	62,8	35,7	2-18UNS-2A	64,0	11,8	

¹ max. cable dia

CA3106E-DN

CA3106E-DN designates a straight plug with backshell for heat-shrinkable boots. CA3106E-DN has an O-ring seal under the coupling nut. It mates with receptacles 3100, 3102, CA02L, CA20E, CA20L and 3101 plugs

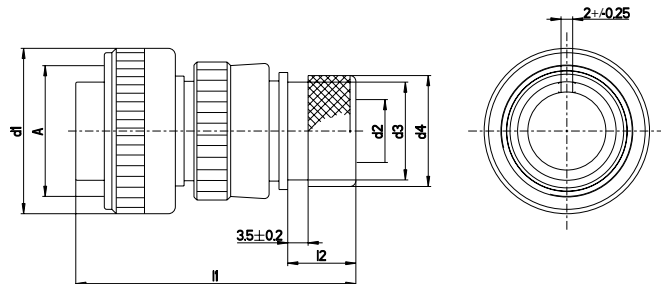

Part No. CA (pin insert*)	A Thread	d1 max.	d2 ¹	d3 max.	d4 ±0,2	l1 max.	l2 ±0,5	
CA3106E10SL-**P-DN	5/8-24UNEF-2B	24,1	7,7	13,3	15,5	49,0	11,7	
CA3106E12S-**P-DN	3/4-20UNEF-2B	25,8	7,9	13,3	15,5	49,0	11,7	
CA3106E14S-**P-DN	7/8-20UNEF-2B	28,8	10,6	17,0	19,1	49,0	11,7	
CA3106E16S-**P-DN	1-20UNEF-2B	31,8	13,5	21,9	23,9	49,0	11,7	
CA3106E16-**P-DN	1-20UNEF-2B	31,8	13,5	21,9	23,9	58,0	11,5	
CA3106E18-**P-DN	1-1/8-18UNEF-2B	34,1	14,6	21,9	23,9	58,0	11,5	
CA3106E20-**P-DN	1-1/4-18UNEF-2B	37,4	18,7	26,2	29,6	60,0	12,7	
CA3106E22-**P-DN	1-3/8-18UNEF-2B	40,5	20,8	26,2	29,6	60,0	12,7	
CA3106E24-**P-DN	1-1/2-18UNEF-2B	43,8	24,6	34,5	37,8	63,0	12,7	
CA3106E28-**P-DN	1-3/4-18UNS-2B	50,2	27,0	34,5	37,8	63,0	12,7	
CA3106E32-**P-DN	2-18UNS-2B	56,4	33,3	43,6	47,8	67,0	15,2	
CA3106E36-**P-DN	2-1/4-16UN-2B	62,8	38,5	43,6	47,8	68,0	15,2	

*For socket inserts substitute "P" with "S" **Add contact arrangement number; see pages 10-22 *** Add modification code; see page 8

¹ max. cable dia

This document solely applies to European manufactured CA Threaded products
Dimensions shown in mm | Specifications and dimensions subject to change

STRAIGHT PLUG PG/ME, SHIELDED

CA3106E...-13/-14/-15

CA3106E...-13/-14/-15 is a shielded straight plug with backshell to accommodate cable braids and heat-shrinkable boots. It has an O-ring under the coupling nut. It mates with receptacles 3100E...-13/-14/-15, 3102, CA02L, CA20E, CA20L and 3101...-13/-14/-15 plugs.

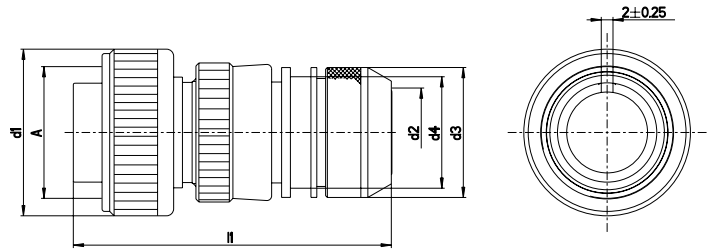

Part No. CA (pin insert*)	A Thread	d1 max.	d2 ¹	d3 ±0,5	d4 max.	l1 max.	l1 max.
CA3106E10SL-**P**	5/8-24UNEF-2B	24,1	7,7	18,5	16,3	55,0	55,0
CA3106E12S-**P**	3/4-20UNEF-2B	25,8	7,9	20,0	17,0	55,0	55,0
CA3106E14S-**P**	7/8-20UNEF-2B	28,8	10,6	22,0	20,0	55,0	55,0
CA3106E16S-**P**	1-20UNEF-2B	31,8	13,5	25,0	23,0	60,0	60,0
CA3106E16-**P**	1-20UNEF-2B	31,8	13,5	25,0	23,0	70,0	70,0
CA3106E18-**P**	1-1/8-18UNEF-2B	34,1	14,6	28,0	24,5	70,0	70,0
CA3106E20-**P**	1-1/4-18UNEF-2B	37,4	14,6	32,0	28,5	70,0	70,0
CA3106E22-**P**	1-3/8-18UNEF-2B	40,5	20,8	34,0	30,5	70,0	70,0
CA3106E24-**P**	1-1/2-18UNEF-2B	43,8	24,6	38,0	34,5	70,0	70,0
CA3106E28-**P**	1-3/4-18UNS-2B	50,2	27,0	41,0	37,5	70,0	70,0
CA3106E32-**P**	2-18UNS-2B	56,4	33,3	48,0	44,0	70,0	70,0
CA3106E36-**P**	2-1/4-16UN-2B	62,8	38,5	55,0	51,0	80,0	80,0

¹ max. cable dia

CA06PG/ME

CA06PG/ME is a straight plug for usage of PG or metric glands. CA06PG / ME has an O-ring seal under the coupling nut. The cable gland is not content of the delivery. It mates with receptacles 3100, 3102, CA02L, CA20E, CA20L and 3101 plugs.

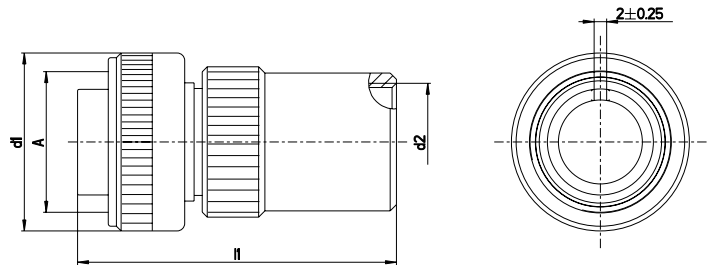

Part No. CA (pin insert*)	CA (pin insert*)	A Thread	d1 max.	d2		l1 max.
				PG-Thread	Metric	
CA06PG10SL-**P-***	CA06ME10SL-**P-***	5/8-24UNEF-2B	24,1	PG9	M16 × 1,5	52,0
CA06PG12S-**P-***	CA06ME12S-**P-***	3/4-20UNEF-2B	25,8	PG9	M16 × 1,5	52,0
CA06PG14S-**P-***	CA06ME14S-**P-***	7/8-20UNEF-2B	28,8	PG11	M20 × 1,5	52,0
CA06PG16S-**P-***	CA06ME16S-**P-***	1-20UNEF-2B	31,8	PG13,5	M20 × 1,5	54,0
CA06PG16-**P-***	CA06ME16-**P-***	1-20UNEF-2B	31,8	PG13,5	M20 × 1,5	64,0
CA06PG18-**P-***	CA06ME18-**P-***	1-1/8-18UNEF-2B	34,1	PG13,5	M25 × 1,5	69,0
CA06PG20-**P-***	CA06ME20-**P-***	1-1/4-18UNEF-2B	37,4	PG16	M25 × 1,5	70,0
CA06PG22-**P-***	CA06ME22-**P-***	1-3/8-18UNEF-2B	40,5	PG16	M32 × 1,5	73,0
CA06PG24-**P-***	CA06ME24-**P-***	1-1/2-18UNEF-2B	43,8	PG16	M32 × 1,5	74,0
CA06PG28-**P-***	CA06ME28-**P-***	1-3/4-18UNS-2B	50,2	PG21	M32 × 1,5	74,0
CA06PG32-**P-***	CA06ME32-**P-***	2-18UNS-2B	56,4	PG29	M40 × 1,5	76,0
CA06PG36-**P-***	CA06ME36-**P-***	2-1/4-16UN-2B	62,8	PG29	M40 × 1,5	87,0

*For socket inserts substitute "P" with "S" **Add contact arrangement number; see pages 10-22 *** Add modification code; see page 8

This document solely applies to European manufactured CA Threaded products
 Dimensions shown in mm | Specifications and dimensions subject to change

CANNON CA THREADED

90° PLUG

CA3108E

CA3108E are right angle plugs which mate with receptacles 3100, 3102, CA02L, CA20E, CA20L and 3101 plugs.
If crimp version is required please order CA3108E...F80 (without O-ring), CA3108E...F183 (without O-ring).

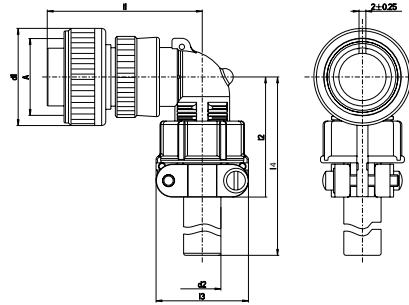

Part No. CA (pin insert*)	A Thread	d1 max.	d2 ¹	I1 max.	I2 max.	I3 max.	I4 max.
CA3108E10SL-**p***	5/8-24UNEF-2B	24,1	6,5	45,0	42,0	22,7	100
CA3108E12S-**p***	3/4-20UNEF-2B	25,8	6,5	45,0	42,0	22,7	100
CA3108E14S-**p***	7/8-20UNEF-2B	28,8	9,0	47,0	42,0	27,5	100
CA3108E16S-**p***	1-20UNEF-2B	31,8	11,0	48,0	45,0	30,0	100
CA3108E16-**p***	1-20UNEF-2B	31,8	11,0	48,0	45,0	30,0	100
CA3108E18-**p***	1-1/8-18UNEF-2B	34,1	14,2	58,0	53,0	33,0	100
CA3108E20-**p***	1-1/4-18UNEF-2B	37,4	15,8	61,0	53,0	37,5	100
CA3108E22-**p***	1-3/8-18UNEF-2B	40,5	15,8	61,0	53,0	37,5	100
CA3108E24-**p***	1-1/2-18UNEF-2B	43,8	21,4	66,0	58,0	43,3	100
CA3108E28-**p***	1-3/4-18UNS-2B	50,2	21,4	66,0	58,0	43,3	100
CA3108E32-**p***	2-18UNS-2B	56,4	26,7	72,0	66,0	51,7	110
CA3108E36-**p***	2-1/4-16UN-2B	62,8	31,7	75,0	69,0	58,0	110

¹ max. cable dia

CA3108R

CA3108R are right angle plugs which mate with receptacles CA3100, CA3101, CA3102, CA02L, CA20E and CA20L. CA 3108R comes without cable clamp. If crimp version is required please order CA3108R...F80 (with O-ring), CA3108R...F183 (with O-ring). It mates with receptacles 3100, 3102, CA02L, CA20L and 3101 plugs.

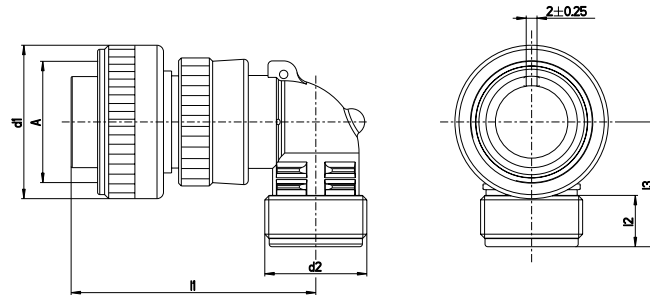

Part No. CA (pin insert*)	A Thread	d1 max.	d2 Thread	I1 max.	I2 min.	I3 max.	I4 max.
CA3108R10SL-**p***	5/8-24UNEF-2B	24,1	5/8-24UNEF-2A	45,0	9,4	22,0	
CA3108R12S-**p***	3/4-20UNEF-2B	25,8	5/8-20UNEF-2A	45,0	9,4	22,0	
CA3108R14S-**p***	7/8-20UNEF-2B	28,8	3/4-20UNEF-2A	47,0	9,4	24,0	
CA3108R16S-**p***	1-20UNEF-2B	31,8	7/8-20UNEF-2A	48,0	9,4	25,0	
CA3108R16-**p***	1-20UNEF-2B	31,8	7/8-20UNEF-2A	48,0	9,4	25,0	
CA3108R18-**p***	1-1/8-18UNEF-2B	34,1	1-20UNEF-2A	58,0	9,4	27,0	
CA3108R20-**p***	1-1/4-18UNEF-2B	37,4	1-3/16-18UNEF-2A	61,0	9,4	29,0	
CA3108R22-**p***	1-3/8-18UNEF-2B	40,5	1-3/16-18UNEF-2A	61,0	9,4	30,0	
CA3108R24-**p***	1-1/2-18UNEF-2B	43,8	1-7/16-18UNEF-2A	66,0	9,4	32,0	
CA3108R28-**p***	1-3/4-18UNS-2B	50,2	1-7/16-18UNEF-2A	66,0	9,4	34,0	
CA3108R32-**p***	2-18UNS-2B	56,4	1-3/4-18UNS-2A	72,0	11,0	39,5	
CA3108R36-**p***	2-1/4-16UN-2B	62,8	2-18UNS-2A	75,0	12,6	45,0	

*For socket inserts substitute "P" with "S" **Add contact arrangement number; see pages 10-22 *** Add modification code; see page 8

¹ max. cable dia

This document solely applies to European manufactured CA Threaded products
Dimensions shown in mm | Specifications and dimensions subject to change

STRAIGHT PLUG ENFORCED BACKSHELL, THROUGH-BULKHEAD CLASS E, R

CA06EA

CA06EA is a straight plug with adapter for gland nut sealing and cable clamp. It is designed for usage with jacketed cable. It provides cable strain relief, individual wire sealing plus sealing of the outer cable jacket. It has an O-ring under the coupling nut. It mates with receptacles 3100, 3102, CA02L, CA20E, CA20L and 3101 plugs

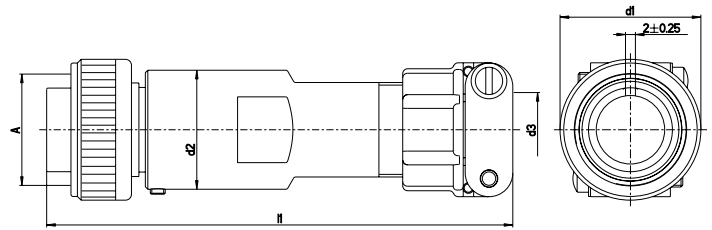

Part No. CA (pin insert*)	A Thread	d1 max.	d2 max.	d3 ¹	l1 max.
CA06EA14S-**p***	7/8-20UNEF-2B	28,8	24,2	11,2	102,0
CA06EA16S-**p***	1-20UNEF-2B	31,8	27,2	13,5	102,0
CA06EA16-**p***	1-20UNEF-2B	31,8	27,2	13,5	112,0
CA06EA18-**p***	1-1/8-18UNEF-2B	34,1	32,2	15,9	112,0
CA06EA20-**p***	1-1/4-18UNEF-2B	37,4	35,2	19,1	112,0
CA06EA22-**p***	1-3/8-18UNEF-2B	40,5	37,2	19,1	112,0
CA06EA24-**p***	1-1/2-18UNEF-2B	43,6	41,2	23,9	115,0
CA06EA28-**p***	1-3/4-18UNS-2B	50,2	47,2	23,9	115,0
CA06EA32-**p***	2-18UNS-2B	56,4	53,2	31,8	120,0
CA06EA36-**p***	2-1/4-16UN-2B	62,8	59,2	34,9	120,0

¹ max. cable dia

THRU-BULKHEAD

TBF

TBF designates a thru-bulkhead featured by a double face construction allowing mating from both ends. It mates with 3106 and 3108 plugs.

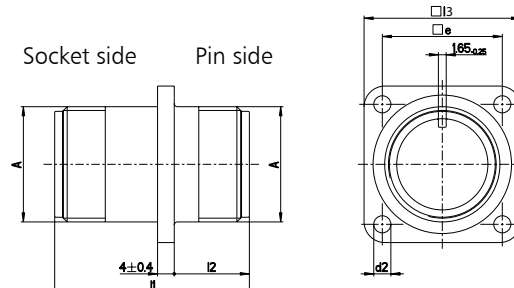

Part No. TBF	A Thread	l1 max.	l2 +0,4	l3 ±0,3	e ±0,1	d2 +0,2/-0,1
TBF10SL-**-**pS***	5/8-24UNEF-2A	40,1	14,2	25,4	18,2	3,1
TBF14S-**-**pS***	7/8-20UNEF-2A	40,1	14,2	30,0	23,0	3,1
TBF16S-**-**pS***	1-20UNEF-2A	40,1	14,2	32,5	24,6	3,1
TBF16-**-**pS***	1-20UNEF-2A	54,4	19,0	32,5	29,4	3,1
TBF18-**-**pS***	1-1/8-18UNEF-2A	54,4	19,0	35,0	31,8	3,1
TBF20-**-**pS***	1-1/4-18UNEF-2A	54,4	19,0	38,0	29,4	3,1
TBF22-**-**pS***	1-3/8-18UNEF-2A	54,4	19,0	41,0	31,8	3,1
TBF24-**-**pS***	1-1/2-18UNEF-2A	54,4	20,6	44,5	34,9	3,7
TBF28-**-**pS***	1-3/4-18UNS-2A	54,4	20,6	50,8	39,7	3,7
TBF32-**-**pS***	2-18UNS-2A	54,4	22,2	57,0	44,5	4,4
TBF36-**-**pS***	2-1/4-16UN-2A	54,4	22,2	63,5	49,2	4,4

*For socket inserts substitute "P" with "S" **Add contact arrangement number; see pages 10-22 *** Add modification code; see page 8

ACCESSORIES

Cable Clamp

These cable clamps can be used with or without bushings. Bushings need to be ordered separately, please see table below.. It is utilized to complete the F class plugs and receptacles on page 25, 28, 33 and CA3108 90° plug on page 35.

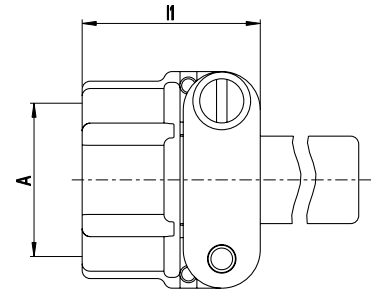
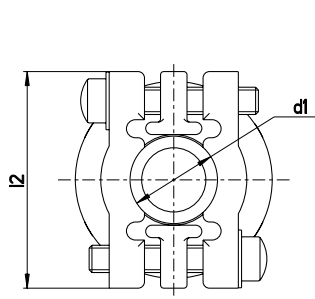

Part No. CA	Shell size	A Thread	d1 max	l1 max	l2 max
VG95234KK 4	10S, 12S, 12	5/8-24NEF-2B	7,9	20,8	22,5
VG95234KK 6	14S, 14	3/4-20UNEF-2B	11,1	22,4	27,4
VG95234KK 8	16S, 16	7/8-20UNEF-2B	14,2	24,0	29,8
VG95234KK10	18	1-20UNEF-2B	15,8	24,0	32,2
VG95234KK12	20, 22	1-3/16-18UNEF-2B	19,0	24,0	37,4
VG95234KK16	24, 28	1-7/16-18UNEF-2B	23,7	26,4	43,5
VG95234KK20	32	1-3/4-18NS-2B	31,8	28,0	51,7
VG95234KK24	36	2-18NS-2B	34,6	29,6	57,8

TELESCOPING BUSHING

Telescoping bushings (used with cable clamp) keep dirt, moisture out of backshell. Taping or wrapping wires is eliminated since bushing protects wires going through clamp. Combination of bushings may be used to decrease cable entry diameter to improve sealing. Material is Polychloroprene.

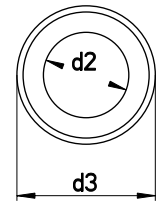
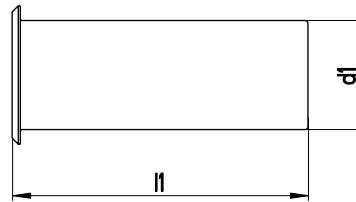

Shell size	part no.	d1	d2	d3	l	Weight g
10SL	012-8552-000	8.0	6.6	9.9	70.0	4
14S	012-8554-000	10.9	9.1	12.7	67.0	5
16S, 16	012-0218-000	14.0	11.1	19.0	64.0	6
18	012-0219-000	15.7	14.3	22.0	60.0	4
20, 22	012-0220-000	18.8	15.9	26.9	57.0	7
24, 28	012-8556-000	23.6	21.5	33.3	54.0	13
32	012-8558-000	31.5	26.8	40.4	51.0	26
36	012-0223-000	34.7	31.8	46.8	48.0	30
24.28	012-8555-000	21.2	16.6	26.9	57.0	13
32	012-8557-000	26.5	21.5	33.3	54.0	26

Shell size	Combination of:
24, 28	012-8556-000 and 012-8555-000
32	012-8558-000 and 012-8557-000
36	012-0223-000 and 012-8558-000

This document solely applies to European manufactured CA Threaded products
Dimensions shown in mm | Specifications and dimensions subject to change

ACCESSORIES

METAL PROTECTING CAPS FOR RECEPTACLES WITH CORD

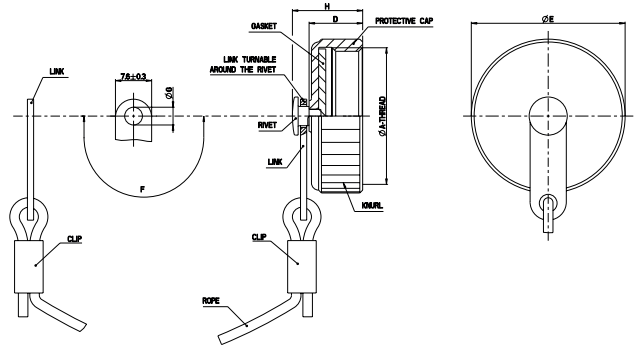

Shell Size	Order designation				ØA Thread	D max.	ØE max.	F ca.	ØG +0,4	H max.
	A66	A232	A240	A241						
10SL	CA121003-801	CA121003-1621	CA121003-1681	CA121003-1721	5/8-24UNEF-2B	11.7	20.2	100	3.4	16.0
12S	CA121003-802	CA121003-1622	CA121003-1682	CA121003-1722	3/4-20UNEF-2B	11.7	23.4	115	3.4	16.0
14S	CA121003-803	CA121003-1623	CA121003-1683	CA121003-1723	7/8-20UNEF-2B	11.7	26.6	115	3.4	16.0
16S, 16	CA121003-804	CA121003-1624	CA121003-1684	CA121003-1724	1-20UNEF-2B	11.7	29.8	115	3.4	16.0
18	CA121003-806	CA121003-1626	CA121003-1686	CA121003-1726	1 1/8-18UNEF-2B	11.7	32.9	115	3.4	16.0
20	CA121003-807	CA121003-1627	CA121003-1687	CA121003-1727	1 1/4-18UNEF-2B	11.7	36.1	125	3.4	16.0
22	CA121003-808	CA121003-1628	CA121003-1688	CA121003-1728	1 3/8-18UNEF-2B	11.7	39.4	125	3.4	16.0
24	CA121003-809	CA121003-1629	CA121003-1689	CA121003-1729	1 1/2-18UNEF-2B	11.7	42.6	140	4.2	16.0
28	CA121003-810	CA121003-1630	CA121003-1690	CA121003-1730	1 3/4-18UNS-2B	13.3	48.9	200	4.2	18.0
32	CA121003-811	CA121003-1631	CA121003-1691	CA121003-1731	2-18UNS-2B	13.3	55.3	200	4.6	18.0
36	CA121003-812	CA121003-1632	CA121003-1692	CA121003-1732	2 1/4-16UN-2B	13.3	61.6	200	4.6	18.0

METAL PROTECTING CAPS FOR RECEPTACLES WITH CHAIN

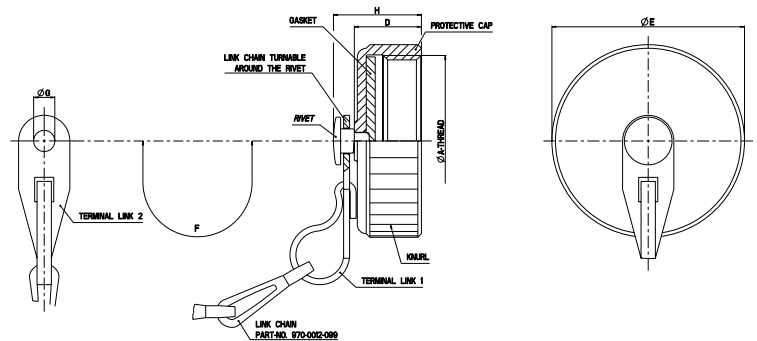

Shell Size	Order designation				ØA Thread	D max.	ØE max.	F ca.	ØG +0,4	H max.
	A66	A232	A240	A241						
10SL	CA2209-5101	CA121003-641	CA121003-681	CA121003-721	5/8-24UNEF-2B	11.7	20.2	100	3.4	16.0
12S	CA2209-5102	CA121003-642	CA121003-682	CA121003-722	3/4-20UNEF-2B	11.7	23.4	115	3.4	16.0
14S	CA2209-5103	CA121003-643	CA121003-683	CA121003-723	7/8-20UNEF-2B	11.7	26.6	115	3.4	16.0
16S, 16	CA2209-5104	CA121003-644	CA121003-684	CA121003-724	1-20UNEF-2B	11.7	29.8	115	3.4	16.0
18	CA2209-5105	CA121003-646	CA121003-686	CA121003-725	1 1/8-18UNEF-2B	11.7	32.9	115	3.4	16.0
20	CA2209-5106	CA121003-647	CA121003-687	CA121003-726	1 1/4-18UNEF-2B	11.7	36.1	125	3.4	16.0
22	CA2209-5107	CA121003-648	CA121003-688	CA121003-727	1 3/8-18UNEF-2B	11.7	39.4	125	3.4	16.0
24	CA2209-5108	CA121003-649	CA121003-689	CA121003-728	1 1/2-18UNEF-2B	11.7	42.6	140	4.2	16.0
28	CA2209-5109	CA121003-650	CA121003-690	CA121003-729	1 3/4-18UNS-2B	13.3	48.9	200	4.2	18.0
32	CA2209-5110	CA121003-651	CA121003-691	CA121003-730	2-18UNS-2B	13.3	55.3	200	4.6	18.0
36	CA2209-5111	CA121003-652	CA121003-692	CA121003-731	2 1/4-16UN-2B	13.3	61.6	200	4.6	18.0

This document solely applies to European manufactured CA Threaded products
 Dimensions shown in mm | Specifications and dimensions subject to change

ACCESSORIES

METAL PROTECTING CAPS FOR PLUGS WITH CORD

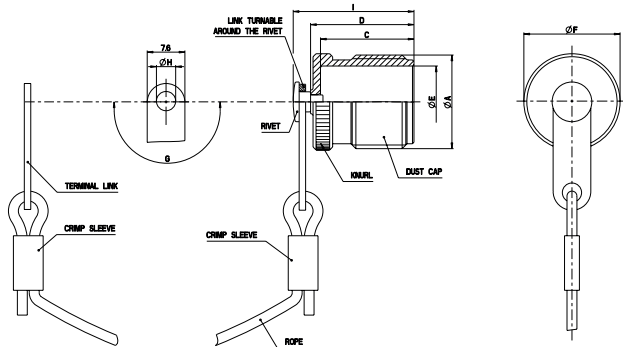

Shell Size	Order designation				ØA Thread	C ±0,5	D max.	ØE +0,2	ØF max.	G ca.	ØH +0,4	I max.
	A66	A232	A240	A241								
10SL	CA121004-801	CA121004-1621	CA121004-1681	CA121004-1721	5/8-24UNEF-2A	14.1	16.3	11.5	16.7	100	3.8	20.5
12S	CA121004-802	CA121004-1622	CA121004-1682	CA121004-1722	3/4-20UNEF-2A	18.9	21.0	14.4	19.8	115	3.8	25.0
14S	CA121004-803	CA121004-1623	CA121004-1683	CA121004-1723	7/8-20UNEF-2A	18.9	21.0	17.6	23.0	115	3.8	25.0
16S, 16	CA121004-804	CA121004-1624	CA121004-1684	CA121004-1724	1-20UNEF-2A	18.9	21.0	20.8	26.2	115	3.8	25.0
18	CA121004-806	CA121004-1626	CA121004-1686	CA121004-1726	1 1/8-18UNEF-2A	18.9	21.0	23.9	29.4	115	3.8	25.0
20	CA121004-807	CA121004-1627	CA121004-1687	CA121004-1727	1 1/4-18UNEF-2A	18.9	21.0	27.1	32.5	125	4.6	25.0
22	CA121004-808	CA121004-1628	CA121004-1688	CA121004-1728	1 3/8-18UNEF-2A	18.9	21.0	30.3	35.7	125	4.6	25.0
24	CA121004-809	CA121004-1629	CA121004-1689	CA121004-1729	1 1/2-18UNEF-2A	18.9	21.0	33.5	38.9	140	4.6	25.0
28	CA121004-810	CA121004-1630	CA121004-1690	CA121004-1730	1 3/4-18UNS-2A	18.9	21.0	39.0	45.2	200	4.6	25.0
32	CA121004-811	CA121004-1631	CA121004-1691	CA121004-1731	2-18UNS-2A	18.9	21.0	45.4	51.6	200	5.4	25.0
36	CA121004-812	CA121004-1632	CA121004-1692	CA121004-1732	2 1/4-16UN-2A	18.9	21.0	50.9	57.9	200	5.4	25.0

METAL PROTECTING CAPS FOR PLUGS WITH CHAIN

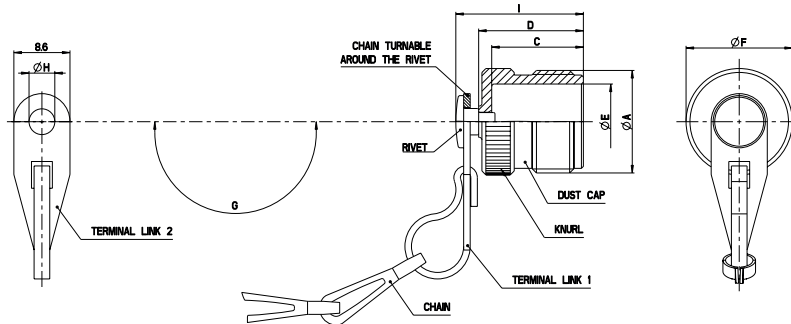

Shell Size	Order designation				ØA Thread	C ±0,5	D max.	ØE +0,2	ØF max.	G ca.	ØH +0,4	I max.
	A66	A232	A240	A241								
10SL	CA17530-5101	CA121004-641	CA121004-681	CA121004-721	5/8-24UNEF-2A	14.1	16.3	11.5	16.7	100	3.8	20.5
12S	CA17530-5102	CA121004-642	CA121004-682	CA121004-722	3/4-20UNEF-2A	18.9	21.0	14.4	19.8	115	3.8	25.0
14S	CA17530-5103	CA121004-643	CA121004-683	CA121004-723	7/8-20UNEF-2A	18.9	21.0	17.6	23.0	115	3.8	25.0
16S, 16	CA17530-5104	CA121004-644	CA121004-684	CA121004-724	1-20UNEF-2A	18.9	21.0	20.8	26.2	115	3.8	25.0
18	CA17530-5105	CA121004-646	CA121004-686	CA121004-726	1 1/8-18UNEF-2A	18.9	21.0	23.9	29.4	115	3.8	25.0
20	CA17530-5106	CA121004-647	CA121004-687	CA121004-727	1 1/4-18UNEF-2A	18.9	21.0	27.1	32.5	125	4.6	25.0
22	CA17530-5107	CA121004-648	CA121004-688	CA121004-728	1 3/8-18UNEF-2A	18.9	21.0	30.3	35.7	125	4.6	25.0
24	CA17530-5108	CA121004-649	CA121004-689	CA121004-729	1 1/2-18UNEF-2A	18.9	21.0	33.5	38.9	140	4.6	25.0
28	CA17530-5109	CA121004-650	CA121004-690	CA121004-730	1 3/4-18UNS-2A	18.9	21.0	39.0	45.2	200	4.6	25.0
32	CA17530-5110	CA121004-651	CA121004-691	CA121004-731	2-18UNS-2A	18.9	21.0	45.4	51.6	200	5.4	25.0
36	CA17530-5111	CA121004-652	CA121004-692	CA121004-732	2 1/4-16UN-2A	18.9	21.0	50.9	57.9	200	5.4	25.0

This document solely applies to European manufactured CA Threaded products
Dimensions shown in mm | Specifications and dimensions subject to change

ACCESSORIES

PROTECTIVE CAPS PLASTIC*

Material: Polyethene
Color: Red

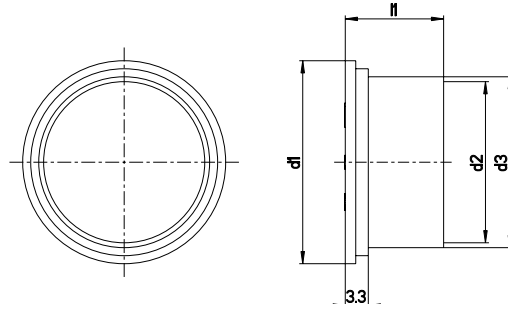

Part No.	CA 3100/3101/3102	CA 3106/3108	d1 max.	l1 max.	d2 ±0,2	d3 max.	Part No.	CA 3100/3101/3102	CA 3106/3108	d1 max.	l1 max.	d2 ±0,2	d3 max.
025-0460-000	10SL		21,5	17,8	15,2	16,9	025-0468-000	20		38,1	17,8	31,5	33,4
025-0477-000		10SL	20,4	12,5	14,0	15,7	025-0469-000	22		39,1	14,6	32,6	34,2
025-0478-000		12S, 12	23,1	14,6	16,8	18,5	025-0486-000		22	41,4	17,8	34,5	36,5
025-0462-000	12S, 12		24,7	17,8	18,5	20,2	025-0487-000		24	42,3	14,6	35,5	37,4
025-0479-000		14S, 14	26,3	14,6	19,9	21,6	025-0510-000	24		44,2	17,8	37,8	39,8
025-0463-000	14S, 14		27,8	17,8	21,6	23,3	025-0488-000		28	48,4	14,6	41,6	43,5
025-0480-000		16S, 16	29,5	14,6	23,1	24,8	025-0501-000	28		50,4	17,8	43,9	45,9
025-0498-000	16S, 16		31,5	17,8	25,1	26,8	025-0489-000		32	54,8	14,6	48,0	49,9
025-0484-000		18	32,8	14,6	25,9	27,8	025-0502-000	32		57,0	17,8	50,3	52,2
025-0507-000	18		34,7	17,8	28,2	30,1	025-0490-000		36	61,3	14,6	54,2	56,3
025-0467-000		20	35,4	17,8	28,3	30,2	025-0503-000	36		63,4	17,8	56,6	58,6

*Dust caps for the connector mating side only

WIRE HOLE FILLERS

Where contacts are not engaged, the contact cavities are to be closed with wire hole fillers. Wire hole fillers are inserted into the rear end of the grommet (see CA-B Assembly instruction available on the ITT webpage www.ittcannon.com)

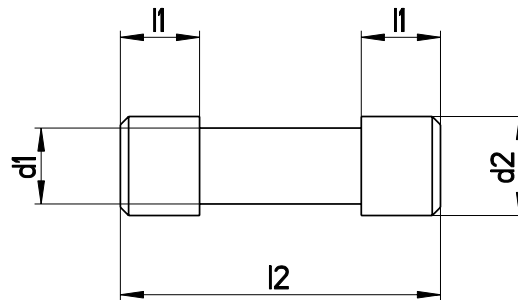

For contact size		d1	d2	l1	l2	Part number	Color
AWG	metric	±0,1	±0,2	±0,1	±0,3		
20	10	2,3	3,0	2,4	9,7	225-1000-000	red
16S	15S	2,8	3,7	1,5	4,8	225-8510-000	nature
16	15	2,8	3,7	3,2	11,9	225-0017-000	blue
12	25	3,7	4,6	3,2	11,9	225-0018-000	yellow
8	60/100	5,0	5,8	3,2	11,9	225-0019-000	white
4	160	7,6	8,5	3,2	11,9	225-8502-000	green
0	500	12,8	13,5	3,2	11,9	225-8503-000	black

This document solely applies to European manufactured CA Threaded products
Dimensions shown in mm | Specifications and dimensions subject to change

ACCESSORIES

SEALING GASKETS

For front and rear panel mounting. These sealing gaskets made of neoprene are used with flange receptacles for sealing purposes between the shell and the flange.

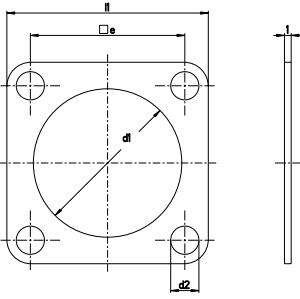

Part No.	Shell size	d1 +0,2	d2 +0,2	l1 ±0,3	e ±0,1		
075-8512-000	10SL	15,7	4,2	25,4	18,2		
075-8513-000	12S	18,9	4,2	28,0	20,6		
075-8514-000	14S	22,1	4,2	30,0	23,0		
075-8515-000	16S,16	25,3	4,2	32,5	24,6		
075-8516-000	18	28,4	4,2	35,0	27,0		
075-8517-000	20	31,6	4,2	38,0	29,4		
075-8518-000	22	34,8	4,2	41,0	31,8		
075-8519-000	24	38,0	4,2	44,5	34,9		
075-8520-000	28	44,3	5,1	50,8	39,7		
075-8521-000	32	50,7	5,1	57,0	44,5		
075-8522-000	36	57,0	5,1	63,5	49,2		

Dummy Receptacle

The dummy receptacle holds 3106 or 3108 plugs when not in use.

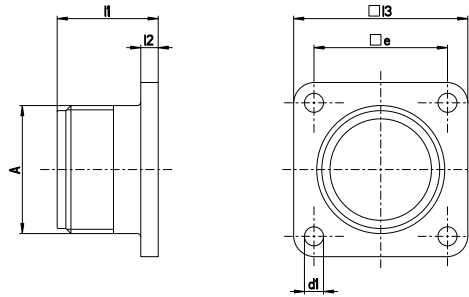

Part No. CA	for shell size	A Thread	l1 max	l2 ±0,2	l3 ±0,7	d1 +0,2/-0,1	e ±0,1	
248-0089-001	10SL	5/8-24UNEF-2B	17,2	2,4	25,4	3,1	18,2	
248-0774-000	12S	3/4-20UNEF-2B	17,2	2,4	28,7	3,1	20,6	
248-0093-001	14S	7/8-20UNEF-2B	17,9	2,4	30,1	3,1	23,0	
248-0095-001	16S	1-20UNEF-2B	17,2	2,4	32,5	3,1	24,6	
248-0094-001	16	1-20UNEF-2B	22,0	2,4	32,5	3,1	24,6	
248-0096-001	18	1-1/8-18UNEF-2B	22,5	3,0	34,9	3,1	27,0	
248-0772-000	20	1-1/4-18UNEF-2B	22,5	3,0	38,0	3,1	29,4	
248-0773-000	22	1-3/8-18UNEF-2B	22,5	3,0	41,3	3,1	31,8	
248-0099-001	24	1-1/2-18UNEF-2B	24,1	3,0	44,4	3,7	34,9	
248-0100-001	28	1-3/4-18UNS-2B	24,1	3,0	50,8	3,7	39,7	
248-0101-001	32	2-18UNS-2B	27,0	4,3	57,1	4,4	44,5	
248-0102-001	36	2-1/4-16UN-2B	27,0	4,3	63,4	4,4	49,2	

This document solely applies to European manufactured CA Threaded products
Dimensions shown in mm | Specifications and dimensions subject to change

ACCESSORIES

CONTACTS

Standard contacts and contacts with reduced termination diameter

SIZE 15S/16S, 15/16, 25/12, 60/100/8, 160/4, 500/0

SIZE 10/20

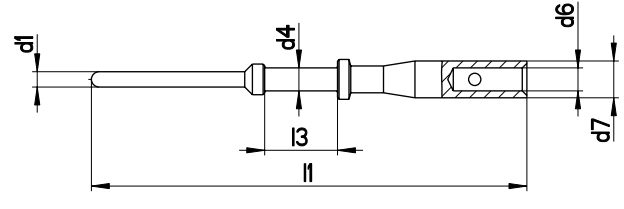
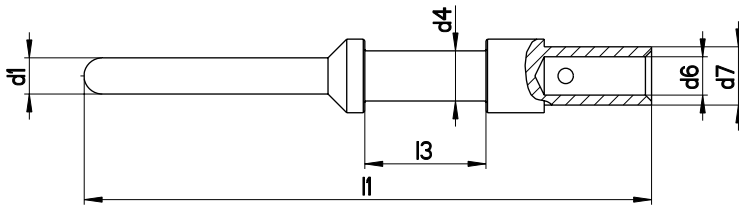

Pin contacts Finish: **A36**–silver plated and passivated/**A176**–gold plated

Contact size	Termination size		Part no. with finish		d1 -0,05	d4	d6	d7	l1 ± 0,15	l3 ± 0,5	Color code
	mm ²	AWG	A36	A176							
10/20	0,5–1,0	20/18	030-8585-000	030-8585-006	1,04	1,50	1,50	2,40	28,4	4,75	–
	0,2–0,4	26/22	030-8585-010	030-8585-016	1,04	1,50	0,90	2,40	28,4	4,75	blue
15S/16S	0,75–1,5	18/16	030-8586-000	030-8586-006	1,60	1,75	1,75	2,75	27,4	3,85	–
	0,3–0,6	22/20	330-8744-000	330-8744-006	1,60	1,75	1,20	2,75	27,4	3,85	red
	0,14–0,38	22/26	030-8586-010	030-8586-016	1,60	1,75	0,90	2,75	27,4	3,85	blue
15/16	0,75–1,5	18/16	030-8587-000	030-8587-006	1,60	1,75	1,75	2,75	31,4	7,90	–
	0,3–0,6	22/20	330-8659-000	030-8559-006	1,60	1,75	1,20	2,75	31,4	7,90	red
	0,14–0,38	22/26	030-8587-030	030-8587-036	1,60	1,75	0,90	2,75	31,4	7,90	blue
25/12	2,0–3,0	14/12	030-8588-000	030-8588-006	2,40	3,30	2,50	3,80	37,0	7,90	–
	0,75–1,5	18/16	030-8588-010	030-8588-016	2,40	3,30	1,75	3,40	37,0	7,90	black
	4,0	–	030-8588-054		2,40	3,30	2,80	3,80	37,0	7,90	–
	6,0	10	030-8589-000		3,60	6,25	3,50	6,80	39,6	6,35	yellow
60/100/8	10,0	–	030-8590-000		3,60	6,25	4,80	6,80	39,6	6,35	–
	2,0–3,0	14/12	030-8612-010		3,60	6,25	2,50	6,80	39,6	6,35	green
	–	4	030-8613-000		5,75	9,55	7,10	9,55	39,6	6,35	–
	16,0	–	030-8591-000		5,75	9,55	6,20	9,55	39,6	6,35	–
160/4	10,0	–	030-8591-020		5,75	9,55	4,80	9,55	39,6	6,35	–
	–	6	030-8613-010		5,75	9,55	5,70	9,55	39,6	6,35	brown
	–	0	030-8614-000		9,10	13,55	11,5	14,35	41,0	6,35	–
	50,0	–	030-8592-000		9,10	13,55	10,7	14,35	41,0	6,35	–
500/0	25,0	4	030-8614-010		9,10	13,55	7,60	14,35	41,0	6,35	white
	35,0	2	030-8614-020		9,10	13,55	9,10	14,35	41,0	6,35	grey
	16,0	–	030-8614-030		9,10	13,55	6,20	14,35	41,0	6,35	–

ACCESSORIES

CONTACTS

Standard contacts and contacts with reduced termination diameter

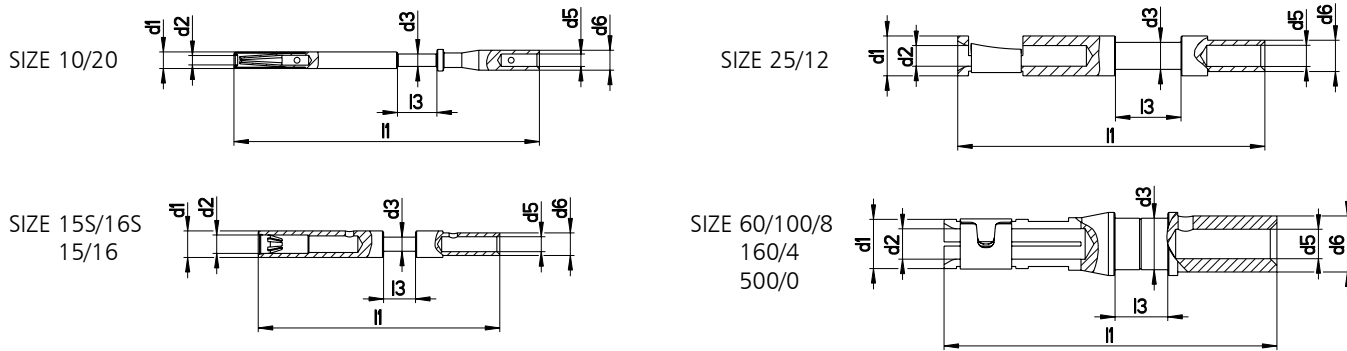

Socket contacts Finish: **A36**–silver plated and passivated/**A176**–gold plated

Contact size	Wire size		Part no. with finish		d1	d2 + 0,05	d3	d5	d6	l1 ± 0,2	l3 ± 0,1	Color code
	mm ²	AWG	A36	A176								
10/20	0,5–1,0	20/18	031-8554-000	031-8554-006	2,0	1,07	1,5	1,5	2,4	36,8 ± 0,3	4,75	–
	0,2–0,4	26/22	031-8554-010	031-8554-016	2,0	1,07	1,5	0,9	2,4	36,8 ± 0,3	4,75	blue
15S/16S	0,75–1,5	18/16	031-8555-110	031-8555-115	3,2	1,65	1,75	1,75	2,75	29,1	3,9	–
	0,3–0,6	22/20	031-8688-110	031-8688-115	3,2	1,65	1,75	1,2	2,75	29,1	3,9	red
	0,14–0,38	22/26	031-8555-130	031-8555-135	3,2	1,65	1,75	0,9	2,75	29,1	3,9	blue
15/16	0,75–1,5	18/16	031-8556-110	031-8556-115	3,2	1,65	1,75	1,75	2,75	37,8	7,9	–
	0,3–0,6	22/20	031-8639-120	031-8639-115	3,2	1,65	1,75	1,2	2,75	37,8	7,9	red
	0,14–0,38	22/26	031-8556-130	031-8556-135	3,2	1,65	1,75	0,9	2,75	37,8	7,9	blue
25/12	2,0–3,0	14/12	031-8557-000	031-8557-006	4,8	2,45	3,3	2,5	3,8	37,0	7,9	–
	0,75–1,5	18/16	031-8557-020	031-8557-026	4,8	2,45	3,3	1,75	3,4	37,0	7,9	black
	4,0	–	031-8557-010	–	4,8	2,45	3,3	2,8	3,8	37,0	7,9	–
	0,3–0,6	22/20	031-8557-040	–	4,8	2,45	3,3	1,2	2,75	37,0	7,9	–
60/100/8	–	8	031-8519-000	031-8519-006	6,5	3,65	6,25	4,55	6,8	40,1	6,35	–
	6,0	10	031-8558-000	–	6,5	3,65	6,25	3,5	6,8	40,1	6,35	yellow
	10,0	–	031-8559-000	–	6,5	3,65	6,25	4,8	6,8	40,1	6,35	–
	2,0–3,0	14/12	031-8519-010	–	6,5	3,65	6,25	2,5	6,8	40,1	6,35	green
160/4	–	4	031-8520-000	–	8,6	5,8	9,55	7,1	9,55	40,1	6,35	–
	16,0	–	031-8560-000	–	8,6	5,8	9,55	6,2	9,55	40,1	6,35	–
	10,0	–	031-8560-020	–	8,6	5,8	9,55	4,8	9,55	40,1	6,35	–
	–	6	031-8520-010	–	8,6	5,8	9,55	5,7	9,55	40,1	6,35	brown
500/0	–	0	031-8521-000	–	13,2	9,15	13,55	11,5	14,35	41,6	6,35	–
	50,0	–	031-8561-000	–	13,2	9,15	13,55	10,7	14,35	41,6	6,35	–
	25,0	4	031-8521-010	–	13,2	9,15	13,55	7,6	14,35	41,6	6,35	white
	35,0	2	031-8521-020	–	13,2	9,15	13,55	9,1	14,35	41,6	6,35	grey
	16,0	–	031-8521-030	–	13,2	9,15	13,55	6,2	14,35	41,6	6,35	–

This document solely applies to European manufactured CA Threaded products
Dimensions shown in mm | Specifications and dimensions subject to change

CA Layout Overview with standard contact wire size

The table below shows all available contact arrangements (layouts) available for ITT's CA product line.

For each layout the crimp contact styles and wire cross sections used as default are shown.

If other crimp sizes are required the connector can be ordered with suffix "-F0" (without contacts).

See ordering key on page 8 for details. In this case, separate contacts can be selected according to contact selection tables on pages 43-44.

*The numbers represent modifications for contact termination as listed on page 8. E.g. CA3106E20-29S-14 is the modification for a shielded endbell with metric crimp contacts.

Layout	No. of Contacts	Contact size	Contact Termination*	
			-F183, -14	-F80, -15
			wire size mm ²	wire size AWG
10SL-3	3	15S/16S	0,75-1,5	18/16
10SL-4	2	15S/16S	0,75-1,5	18/16
12S-3	2	15S/16S	0,75-1,5	18/16
12S-4	1	15S/16S	0,75-1,5	18/16
12SA10	4	15S/16S	0,75-1,5	18/16
14S-1	3	15S/16S	0,75-1,5	18/16
14S-2	4	15S/16S	0,75-1,5	18/16
14S-4	1	15S/16S	0,75-1,5	18/16
14S-5	5	15S/16S	0,75-1,5	18/16
14S-6	6	15S/16S	0,75-1,5	18/16
14S-7	3	15S/16S	0,75-1,5	18/16
14S-9	2	15S/16S	0,75-1,5	18/16
14SA7	7	15S/16S	0,75-1,5	18/16
16S-1	7	15S/16S	0,75-1,5	18/16
16S-4	2	15S/16S	0,75-1,5	18/16
16S-5	3	15S/16S	0,75-1,5	18/16
16S-8	5	15S/16S	0,75-1,5	18/16
16-7	2	15/16	0,75-1,5	18/16
	1	60/100/8	10.0	8
16-9	2	15/16	0,75-1,5	18/16
	2	25/12	2,0-3,0	14/12
16-10	3	25/12	2,0-3,0	14/12
16-11	2	25/12	2,0-3,0	14/12
16-12	1	160/4	16.0	4
16A11	2	25/12	2,0-3,0	14/12
18-1	10	15/16	0,75-1,5	18/16
18-3	2	25/12	2,0-3,0	14/12
18-4	4	15/16	0,75-1,5	18/16
18-5	2	25/12	2,0-3,0	14/12
	1	15/16	0,75-1,5	18/16
18-6	1	160/4	16.0	4
18-7	1	60/100/8	10.0	8
18-8	1	25/12	2,0-3,0	14/12
	7	15/16	0,75-1,5	18/16
18-9	5	15/16	0,75-1,5	18/16

Layout	No. of Contacts	Contact size	Contact Termination*	
			-F183, -14	-F80, -15
			wire size mm ²	wire size AWG
	2	25/12	2,0-3,0	18/16
18-10	4	25/12	2,0-3,0	14/12
18-11	5	25/12	2,0-3,0	14/12
18-12	6	15/16	0,75-1,5	18/16
18-13	3	25/12	2,0-3,0	14/12
	1	60/100/8	10.0	8
18-17	2	25/12	2,0-3,0	14/12
	5	15/16	0,75-1,5	18/16
18-19	10	15/16	0,75-1,5	18/16
18-20	5	15/16	0,75-1,5	18/16
18-21	3	25/12	2,0-3,0	14/12
18-22	3	15/16	0,75-1,5	18/16
20-2	1	500/0	50.0	0
20-3	3	25/12	2,0-3,0	14/12
20-4	4	25/12	2,0-3,0	14/12
20-6	3	15/16	0,75-1,5	18/16
20-7	8	15/16	0,75-1,5	18/16
20-8	4	15/16	0,75-1,5	18/16
	2	60/100/8	10.0	8
20-11	13	15/16	0,75-1,5	18/16
20-14	3	25/12	2,0-3,0	14/12
	2	60/100/8	10.0	8
20-15	7	25/12	2,0-3,0	14/12
20-16	2	25/12	2,0-3,0	14/12
	7	15/16	0,75-1,5	18/16
20-17	5	25/12	2,0-3,0	14/12
	1	15/16	0,75-1,5	18/16
20-18	3	25/12	2,0-3,0	14/12
	6	15/16	0,75-1,5	18/16
20-19	3	60/100/8	10.0	8
20-22	3	15/16	0,75-1,5	18/16
	3	60/100/8	10.0	8
20-23	2	60/100/8	10.0	8
20-24	2	15/16	0,75-1,5	18/16
	2	60/100/8	10.0	8
20-27	14	15/16	0,75-1,5	18/16
20-29	17	15/16	0,75-1,5	18/16
20-33	11	15/16	0,75-1,5	18/16
20A9	9	25/12	2,0-3,0	14/12
20A24	24	15/16	0,75-1,5	18/16
20A48	19	15/16	0,75-1,5	18/16
22-1	2	60/100/8	10.0	8
22-2	3	60/100/8	10.0	8
22-4	2	25/12	2,0-3,0	14/12
	2	60/100/8	10.0	8
22-5	2	25/12	2,0-3,0	14/12
	4	15/16	0,75-1,5	18/16
22-7	1	500/0	50.0	0
22-8	2	25/12	2,0-3,0	14/12
22-9	3	25/12	2,0-3,0	14/12
22-10	4	15/16	0,75-1,5	18/16
22-12	2	60/100/8	10.0	8
	3	15/16	0,75-1,5	18/16
22-14	19	15/16	0,75-1,5	18/16
22-15	5	25/12	2,0-3,0	14/12
	1	15/16	0,75-1,5	18/16

Layout	No. of Contacts	Contact size	Contact Termination*	
			-F183, -14	-F80, -15
			wire size mm ²	wire size AWG
22-16	3	25/12	2,0-3,0	14/12
	6	15/16	0,75-1,5	18/16
22-19	14	15/16	0,75-1,5	18/16
22-20	9	15/16	0,75-1,5	18/16
22-21	2	15/16	0,75-1,5	18/16
	1	500/0	50.0	0
22-22	4	60/100/8	10.0	8
22-23	8	25/12	2,0-3,0	14/12
22-27	1	60/100/8	10.0	8
	8	15/16	0,75-1,5	18/16
22-28	7	25/12	2,0-3,0	14/12
24-2	7	25/12	2,0-3,0	14/12
24-4	1	500/0	50.0	0
	3	15/16	0,75-1,5	18/16
24-5	16	15/16	0,75-1,5	18/16
24-6	8	25/12	2,0-3,0	14/12
24-7	2	25/12	2,0-3,0	14/12
	14	15/16	0,75-1,5	18/16
24-9	2	160/4	16.0	4
24-10	7	60/100/8	10.0	8
24-11	6	25/12	2,0-3,0	14/12
	3	60/100/8	10.0	-
24-12	3	25/12	2,0-3,0	14/12
	2	160/4	16.0	4
24-19	12	15/16	0,75-1,5	18/16
24-20	2	25/12	2,0-3,0	14/12
	9	15/16	0,75-0,5	18/16
24-22	4	60/100/8	10.0	8
24-27	7	15/16	0,75-1,5	18/16
24-28	24	15/16	0,75-1,5	18/16
24A24	12	25/12	2,0-3,0	14/12
24A28	28	15/16	0,75-1,5	18/16
24A51	13	15/16	0,75-1,5	18/16
	5	25/12	2,0-3,0	14/12
	1	60/100/8	10.0	8
28-2	12	15/16	0,75-1,5	18/16
	2	25/12	2,0-3,0	14/12
28-5	2	15/16	0,75-1,5	18/16
	2	160/4	16.0	4
	1	25/12	2,0-3,0	14/12
28-9	6	15/16	0,75-1,5	18/16
	6	25/12	2,0-3,0	14/12
28-10	2	160/4	16.0	4
	2	60/100/8	10.0	8
	3	25/12	2,0-3,0	14/12
28-11	18	15/16	0,75-1,5	18/16
	4	25/12	2,0-3,0	14/12
28-12	26	15/16	0,75-1,5	18/16
28-15	35	15/16	0,75-1,5	18/16
28-16	20	15/16	0,75-1,5	18/16
28-20	4	15/16	0,75-1,5	18/16
	10	25/12	2,0-3,0	14/12
28-21	37	15/16	0,75-1,5	18/16
28-22	3	160/4	16.0	4

Layout	No. of Contacts	Contact size	Contact Termination*	
			-F183, -14	-F80, -15
			wire size mm ²	wire size AWG
	3	15/16	0,75-1,5	18/16
28-51	12	25/12	2,0-3,0	14/12
28A16	4	160/4	16.0	4
	5	15/16	0,75-1,5	18/16
28A51	43	15/16	0,75-1,5	18/16
28A63	19	15/16	0,75-1,5	18/16
	9	25/12	2,0-3,0	14/12
32-1	3	25/12	2,0-3,0	14/12
	2	500/0	50.0	0
32-5	2	500/0	50.0	0
32-6	16	15/16	0,75-1,5	18/16
	2	25/12	2,0-3,0	14/12
	3	60/100/8	10.0	8
	2	160/4	16.0	4
32-7	28	15/16	0,75-1,5	18/16
	7	25/12	2,0-3,0	14/12
32-8	6	25/12	2,0-3,0	14/12
	24	15/16	0,75-1,5	18/16
32-9	12	15/16	0,75-1,5	18/16
	2	160/4	16	4
32-13	5	25/12	2,0-3,0	14/12
	18	15/16	0,75-1,5	18/16
32-15	6	25/12	2,0-3,0	14/12
	2	500/0	50.0	0
32-17	4	160/4	16.0	4
32A10	54	15/16	0,75-1,5	18/16
32A47	47	15/16	0,75-1,5	18/16
32A55	55	15/16	0,75-1,5	18/16
32A69	41	10/20	0,5-1,0	20/18
	20	15/16	0,75-1,5	18/16
36-3	3	500/0	50.0	0
	3	25/12	2,0-3,0	14/12
36-5	4	500/0	50.0	0
36-6	4	160/4	16.0	4
	2	500/0	50.0	0
36-7	7	25/12	2,0-3,0	14/12
	40	15/16	0,75-1,5	18/16
36-8	1	25/12	2,0-3,0	14/12
	46	15/16	0,75-1,5	18/16
36-9	14	15/16	0,75-1,5	18/16
	14	25/12	2,0-3,0	14/12
	2	60/100/8	10.0	8
	1	160/4	16.0	4
36-10	48	15/16	0,75-1,5	18/16
36-14	5	60/100/8	10.0	8
	5	25/12	2,0-3,0	14/12
	6	15/16	0,75-1,5	18/16
36-15	35	15/16	0,75-1,5	18/16
36A34	52	15/16	0,75-1,5	18/16
36A35	4	15/16	0,75-1,5	18/16
	4	500/0	50.0	0
36A46	27	25/12	2,0-3,0	14/12
36A98	8	60/100/8	10	8
	31	15/16	0,75-1,5	18/16
36A99	15	15/16	0,75-1,5	18/16
	50	10/20	0,2-0,4	26/22

This document solely applies to European manufactured CA Threaded products
Dimensions shown in mm | Specifications and dimensions subject to change

Crimp Tools

For pin and socket contacts according VG95234 and for Cannon contacts with reduced coupling dimensions.

	Contact Size	Wire size mm ²	AWG	Hand Crimp Tools	Order Reference	Crimp Locator	Order Reference			
Pin	10	0,5-1,0	20/18	M22520-1-01	995-0001-585	600325	121586-0034			
		0,2-0,4	26/22							
	15S/16S	0,75-1,5	18/16							
		0,3-0,6	22/20							
		0,14-0,38	22/26							
	Socket	15S/16S	0,750-1,5			18/16			TH 452	995-0002-052
			0,3-0,6			22/20				
			0,14-0,38			22/26				
		15/16	0,75-1,5			18/16				
			0,3-0,6			22/20				
		0,14-0,38	22/26							
25/12		2,0-3,0	14/12							
		0,75-1,5	18/16							
	4									
	Contact Size	Wire size mm ²	AWG	Hydraulic Handpump	Order Number	Electro Hydraulic Tool	Order Number			
	60/100/8	6 2,0-3,0	8 10 14/12	HPW400U-ITT	121586-5257	HP400EL-ITT	121586-5253			
	160/4	16 10	4 6							
	500/0	50 25 35 16	0 - 4 2 -							

Insertion & Extraction Tools

Crimp contacts should be inserted or, if needed, extracted with the correct tools. In order to avoid damage to the insulator it is recommended to use guide pins for the insertion of socket contacts.

Insertion Tools Part No.	Order Reference	Insertion Pliers Part No.	Order Reference	Extraction Tools Part No.	Order Reference	Guiding Pins for Socket Contacts
CIT 20	121086-3009	CIT-F80-20	121086-0098	CET-F80-20	121086-0082	
CIT 16	121086-3008	CIT-F80-16	121086-0097	CET-F80-16	121086-0081	27977-16T50
CIT 12	121086-3007	CIT-F80-12	121086-0096	CET-F80-12	121086-0080	27977-12T8
CIT 8	121086-0095			CET-8	121086-0079	
CIT 4	121086-0094			CET-4	121086-0078	
CIT 0	121086-0093			CET-0	121086-0077	



Basic - Hydraulic - Electrically driven tool - Version A



H- Crimp Head

Electro Hydraulic Crimp Tool

Foot Pedal

Basic - Hydraulic - Manual Operated tool - Version B



H- Crimp Head

Pump Handle with Reset Function

Handle

Basic - Manual operated crimp tool - Version C



Version	Description	Marking	Part Number
A	Electro-Hydraulic Crimp tool set with foot pedal, hand control and crimp head	HP700EL-ITT	121586-5279
A (Accessory)	Switch mode power supply	SNT4-ITT	121586-5280
A (Accessory)	Lithium Ion Battery 18V 3A with recharger	LGA4-ITT	121586-5281
B	Manually operated Hydraulic handtool	HPW400U-ITT	121586-5257
C	Hand Crimp Tool	M22520-1-01	995-0001-585



Crimp tool and Bench mount



Foot pedal



Gauge

Description	Marking	Part Number
Pneumatic crimp tool (AWG 12 - 20)	WA27F-CE	121586-5067
Bench mount	BM-2	121586-5068
Foot pedal	WA10	121586-5069
Gauge	M22520-3-1	995-0001-684

Crimp Dies

Product	Contact Size	Part Number	Hex. Diameter	Stamped label	Cable Size AWG	mm ²
Crimp die	60/100/8	121586-5231	5,20	01	8	6/10
	160/4	121586-5230	7,25	02	4	16
	500/0	121586-5229	11,40	03	0	50
Locator	MS / CA	121586-5232				



Crimp die with locator



Crimp die



Locator

Notes

1. For insertion and extraction of the contacts and for connector assembly see Assembly instructions CAS25094
2. Standard contacts acc. to VG95234

This note must be read in conjunction with the Product data sheet / catalog. Failure to observe the advice in this information sheet and the operating conditions specified in the product data sheet / catalog could result in hazardous situations.

1. MATERIAL CONTENT AND PHYSICAL FORM

Electrical connectors do not usually contain hazardous materials. They contain conducting and non-conducting materials and can be divided into two groups:

- a) Printed circuit types and low-cost audio types which employ all plastic insulators and casings;
- b) Rugged, Fire Barrier and High Reliability types with metal casings and either natural rubber, synthetic rubber, plastic, or glass insulating materials.

Contact materials vary with type of connector and application and are usually manufactured from either copper, copper alloys, nickel, alumel, chromel or steel. In special applications, other alloys may be used.



2. FIRE CHARACTERISTICS AND ELECTRIC SHOCK HAZARD

There is no fire hazard when the connector is correctly wired and used within the specified parameters. Incorrect wiring or assembly of the connector or careless use of metal tools or conductive fluids, or transit damage to any of the component parts may cause electric shock or burns. Live circuits must not be broken by separating mated connectors as this may cause arcing, ionization and burning. Heat dissipation is greater at maximum resistance in a circuit. Hot spots may occur when resistance is raised locally by damage (e.g., cracked, or deformed contacts, broken strands of wire). Local overheating may also result from the use of the incorrect application tools or from poor quality soldering or slack screw terminals. Overheating may occur if the ratings in the product data sheets/catalogues are exceeded and can cause breakdown of insulation and hence electric shock. If heating is allowed to continue, it intensifies by further increasing the local resistance through loss of temper of spring contacts, formation of oxide film on contacts and wires and leakage currents through carbonization of insulation and tracking paths. Fire can then result in the presence of combustible materials, and this may release noxious fumes. Overheating may not be visually apparent. Burns may result from touching overheated components.

3. HANDLING

Care must be taken to avoid damage to any component parts of electrical connectors during installation and use. Although there are normally no sharp edges, care must be taken when handling certain components to avoid injury to fingers. Electrical connectors may be damaged in transit to the customers, and damage may result in creation of hazards. Products should therefore be examined prior to installation/use and rejected if found to be damaged.

4. DISPOSAL

Incineration of certain materials may release noxious or even toxic fumes.

5. APPLICATION

Connectors with exposed contacts should not be selected for use on the current supply side of an electrical circuit because an electric

This document solely applies to European manufactured CA Threaded products
Dimensions shown in mm | Specifications and dimensions subject to change

shock could result from touching exposed contacts on an unmated connector. Voltages more than 30 V ac or 42.5 V dc are potentially hazardous, and care should be taken to ensure that such voltages cannot be transmitted in any way to exposed metal parts of the connector body. The connector and wiring should be checked before making live to ensure that there is no damage to metal parts or insulators, no solder blobs, loose strands, conducting lubricants, swarf, or any other undesired conducting particles. Circuit resistance and continuity check should be made to make certain that there are no high resistance joints or spurious conducting paths. Always use the correct application tools as specified in the data sheets/catalogues. Do not permit untrained personnel to wire, assemble or tamper with connectors. For operation voltage please see appropriate regulations for the applicable region/country.

6. IMPORTANT GENERAL INFORMATION

(i) **Air and creepage paths/Operating voltage.** The admissible operating voltages depend on the individual applications and the applicable safety regulations (including, but not limited to, region/country-specific regulations). For this reason, the air and creepage path data are only reference values. A reduction of air and creepage paths due to PC board and/or harnessing is normal.

(ii) **Temperature.** All information given are temperature limits. The operation temperature depends on the individual application.

(iii) **Other important information.** ITT continuously endeavors to improve its products. Therefore, the products may deviate from the description, technical data and shape as shown in this catalogue and/or data sheets.

7. MISCELLANEOUS

"Cannon" and "Veam" are brands of ITT, Inc. ("ITT"). ITT's connector products are intended to be used in accordance with the specifications in this publication (and any other relevant publications that are applicable to the specific product). Any use or application that deviates from the stated operating specifications is not recommended and may be unsafe. No information and data contained in this publication shall be construed to create any liability on the part of ITT or its successors, assigns, officers, directors, employees, affiliates, and agents, including, but not limited to, any liability for any patent infringements or other rights of third parties which may result from its use. Any new issue of this publication shall automatically invalidate and supersede all previous issues. Reprinting this publication is generally permitted, provided that ITT's prior written consent is obtained, and the source is indicated.

This publication is not to be construed as an offer. It is intended merely as an invitation to make an offer. Product availability, prices, and delivery dates are exclusively subject to ITT's order confirmation form; the same applies to orders based on development samples delivered. Please refer to ITT's Terms and Conditions of Sale located at www.ittcannon.com for the full text of the terms and conditions that apply to ITT's connector products.

Commodities in this catalogue may be controlled for export by the International Traffic in Arms Regulations (ITAR) and Export Administration Regulations (EAR) when specifically designed, modified, or configured for articles controlled by the United States Government.

cannon

Amazing things
happen when great
things connect



Connect with your ITT Cannon representative today
or visit us at ittcannon.com

Connect with the experts

ITT Cannon is a world leader in the design and manufacture of highly engineered connector solutions for multiple end markets.



Why ITT

ITT is a focused multi-industrial company that designs and manufactures highly engineered critical components and customized technology solutions. ITT's Cannon brand is a leading global manufacturer of connector products serving international customers in aerospace, defense, medical, industrial and transportation end markets. ITT's Connector business, which also includes the Veam and BIW Connector Systems brand, manufactures and supplies a variety of connectors and interconnects that make it possible to transfer data, signal and power in an increasingly connected world.

Connect with your ITT Cannon representative today or visit us at ittcannon.com

Follow us 

CHINA - Shenzhen City
+86.755.2726.7888

GERMANY - Weinstadt
+49.7151.699.0

ITALY - Lainate
+39.02938721

KOREA
+82.2.702.7111

SHANGHAI
+ 86.21.2231.2222

UK - Basingstoke
+44.1256.347400

FRANCE
+33.1.60.04.93.93

HONG KONG
+852.2732.2720

JAPAN - Kanagawa
+81.462.57.2010

MEXICO - Nogales
+52.631.311.0050

SINGAPORE
+65 66974205

USA - Irvine, CA
+1.800.854.3028

X-ON Electronics

Largest Supplier of Electrical and Electronic Components

Click to view similar products for [Circular MIL Spec Connector](#) category:

Click to view products by [ITT](#) manufacturer:

Other Similar products are found below :

[89075GULPR](#) [0025-262-542](#) [0025-263-3014](#) [0025-264-3014](#) [0031-065-002](#) [0031-071-002](#) [58-570121-04S](#) [58-584653-12P](#) [0134-201-1007](#)
[0134-202-0800](#) [0134-202-1200](#) [0134-202-2407](#) [0134-207-1206](#) [0134-207-1800](#) [0134-207-2207](#) [0134-213-0806](#) [0134-213-1007](#) [0134-213-1009](#) [0134-213-1200](#) [0134-213-1208](#) [0134-213-1800](#) [0134-213-2209](#) [0025-258-000](#) [0025-259-542](#) [0031-066-002](#) [0031-068-002](#) [0031-069-002](#) [0031-070-002](#) [0031-072-002](#) [015-9516-002](#) [020313-0043](#) [020340-0009](#) [020418-0036](#) [020419-0080](#) [020419-0120](#) [020420-0108](#) [60-042217-10P](#) [0104-201-2402](#) [0114-201-1278](#) [024251-0015](#) [602GB06EG1832SN](#) [0134-201-1207](#) [0134-201-1410](#) [0134-201-1806](#) [0134-201-2006](#) [0134-201-2007](#) [0134-201-2010](#) [0134-201-2200](#) [0134-202-1400](#) [0134-207-0809](#)