

N-Channel Enhancement Mode  
 Low  $Q_g$  and  $R_g$   
 High  $dv/dt$   
 Nanosecond Switching  
 Ideal for Class C, D, & E Applications

$V_{DSS} = 500 \text{ V}$   
 $I_{D25} = 16 \text{ A}$   
 $R_{DS(on)} = 0.4 \Omega$   
 $P_{DC} = 590 \text{ W}$

Symbol	Test Conditions	Maximum Ratings	
$V_{DSS}$	$T_J = 25^\circ\text{C}$ to $150^\circ\text{C}$	500	V
$V_{DGR}$	$T_J = 25^\circ\text{C}$ to $150^\circ\text{C}$ ; $R_{GS} = 1 \text{ M}\Omega$	500	V
$V_{GS}$	Continuous	$\pm 20$	V
$V_{GSM}$	Transient	$\pm 30$	V
$I_{D25}$	$T_c = 25^\circ\text{C}$	16	A
$I_{DM}$	$T_c = 25^\circ\text{C}$ , pulse width limited by $T_{JM}$	96	A
$I_{AR}$	$T_c = 25^\circ\text{C}$	16	A
$E_{AR}$	$T_c = 25^\circ\text{C}$	20	mJ
$dv/dt$	$I_S \leq I_{DM}$ , $di/dt \leq 100 \text{ A}/\mu\text{s}$ , $V_{DD} \leq V_{DSS}$ , $T_J \leq 150^\circ\text{C}$ , $R_G = 0.2 \Omega$	5	V/ns
	$I_S = 0$	>200	V/ns
$P_{DC}$		590	W
$P_{DHS}$	$T_c = 25^\circ\text{C}$ Derate $1.9 \text{ W}/^\circ\text{C}$ above $25^\circ\text{C}$	284	W
$P_{DAMB}$	$T_c = 25^\circ\text{C}$	3.0	W
$R_{thJC}$		0.25	C/W
$R_{thJHS}$		0.53	C/W

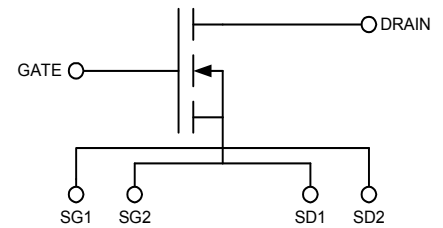

#### Features

- Isolated Substrate
  - high isolation voltage (>2500V)
  - excellent thermal transfer
  - Increased temperature and power cycling capability
- IXYS advanced low  $Q_g$  process
- Low gate charge and capacitances
  - easier to drive
  - faster switching
- Low  $R_{DS(on)}$
- Very low insertion inductance (<2nH)
- No beryllium oxide (BeO) or other hazardous materials

#### Advantages

- Optimized for RF and high speed switching at frequencies to 100MHz
- Easy to mount—no insulators needed
- High power density

Symbol	Test Conditions	Characteristic Values		
		min.	typ.	max.
$T_J = 25^\circ\text{C}$ unless otherwise specified				
$V_{DSS}$	$V_{GS} = 0 \text{ V}$ , $I_D = 3 \text{ ma}$	500		V
$V_{GS(th)}$	$V_{DS} = V_{GS}$ , $I_D = 4 \text{ ma}$	3.5	4.0	5.5 V
$I_{GSS}$	$V_{GS} = \pm 20 \text{ V}_{DC}$ , $V_{DS} = 0$			$\pm 100 \text{ nA}$
$I_{DSS}$	$V_{DS} = 0.8 V_{DSS}$ , $T_J = 25^\circ\text{C}$ $V_{GS} = 0$ , $T_J = 125^\circ\text{C}$			50 $\mu\text{A}$
				1 mA
$R_{DS(on)}$	$V_{GS} = 15 \text{ V}$ , $I_D = 0.5 I_{D25}$ Pulse test, $t \leq 300 \mu\text{s}$ , duty cycle $d \leq 2\%$		.38	$\Omega$
$g_{fs}$	$V_{DS} = 20 \text{ V}$ , $I_D = 0.5 I_{D25}$ pulse test	3	5	8 S
$T_J$		-55		+175 $^\circ\text{C}$
$T_{JM}$			175	$^\circ\text{C}$
$T_{stg}$		-55		+175 $^\circ\text{C}$
$T_L$	1.6mm(0.063 in) from case for 10 s		300	$^\circ\text{C}$
<b>Weight</b>			2	g

Symbol	Test Conditions	Characteristic Values		
		(T <sub>J</sub> = 25°C unless otherwise specified)		
		min.	typ.	max.
R <sub>G</sub>			0.3	Ω
C <sub>iss</sub>			1650	pF
C <sub>oss</sub>	V <sub>GS</sub> = 0 V, V <sub>DS</sub> = 0.8 V <sub>DSS(max)</sub> , f = 1 MHz		122	pF
C <sub>rss</sub>			33	pF
C <sub>stray</sub>	Back Metal to any Pin		21	pF
T <sub>d(on)</sub>			3	ns
T <sub>on</sub>	V <sub>GS</sub> = 15 V, V <sub>DS</sub> = 0.8 V <sub>DSS</sub> I <sub>D</sub> = 0.5 I <sub>DM</sub>		2	ns
T <sub>d(off)</sub>	R <sub>G</sub> = 0.2 Ω (External)		4	ns
T <sub>off</sub>			5	ns
Q <sub>g</sub>			50	nC
Q <sub>gs</sub>	V <sub>GS</sub> = 10 V, V <sub>DS</sub> = 0.5 V <sub>DSS</sub> I <sub>D</sub> = 0.5 I <sub>D25</sub>		12	nC
Q <sub>gd</sub>			24	nC

**Source-Drain Diode**

**Characteristic Values**

(T<sub>J</sub> = 25°C unless otherwise specified)

Symbol	Test Conditions	Characteristic Values		
		(T <sub>J</sub> = 25°C unless otherwise specified)		
		min.	typ.	max.
I <sub>S</sub>	V <sub>GS</sub> = 0 V			6 A
I <sub>SM</sub>	Repetitive; pulse width limited by T <sub>JM</sub>			98 A
V <sub>SD</sub>	I <sub>F</sub> = I <sub>S</sub> , V <sub>GS</sub> = 0 V, Pulse test, t ≤ 300 μs, duty cycle ≤ 2%			1.5 V
T <sub>rr</sub>			200	ns
Q <sub>RM</sub>	I <sub>F</sub> = I <sub>S</sub> , -di/dt = 100A/μs, V <sub>R</sub> = 100V		0.6	μC
I <sub>RM</sub>			4	A

For detailed device mounting and installation instructions, see the “*Device Installation & Mounting Instructions*” technical note on the IXYSRF web site at;

[http://www.ixysrf.com/pdf/switch\\_mode/appnotes/7de\\_series\\_mosfet\\_installation\\_instructions.pdf](http://www.ixysrf.com/pdf/switch_mode/appnotes/7de_series_mosfet_installation_instructions.pdf)

IXYS RF reserves the right to change limits, test conditions and dimensions.

IXYS RF MOSFETS are covered by one or more of the following U.S. patents:

4,835,592	4,860,072	4,881,106	4,891,686	4,931,844	5,017,508
5,034,796	5,049,961	5,063,307	5,187,117	5,237,481	5,486,715
5,381,025	5,640,045				

Fig. 1

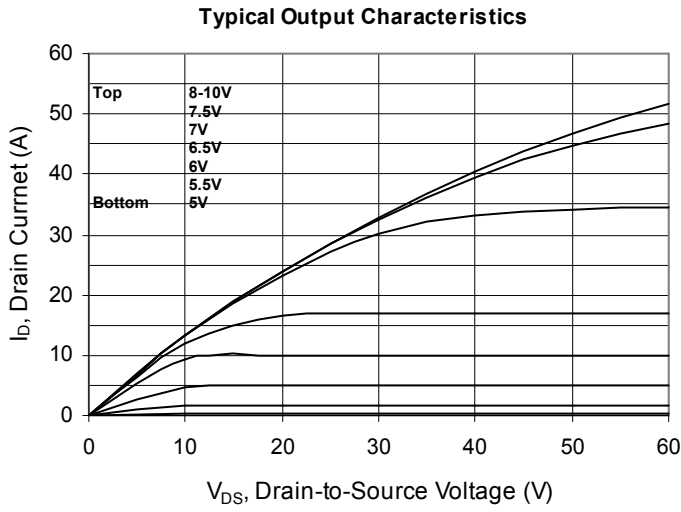

Fig. 2

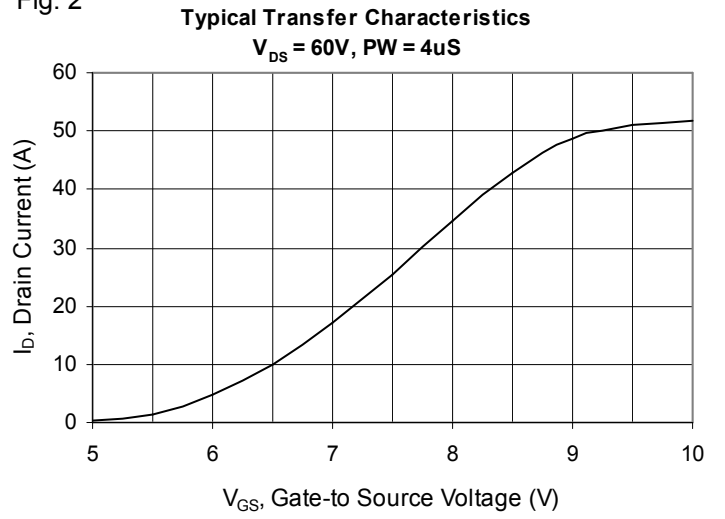

Fig. 3

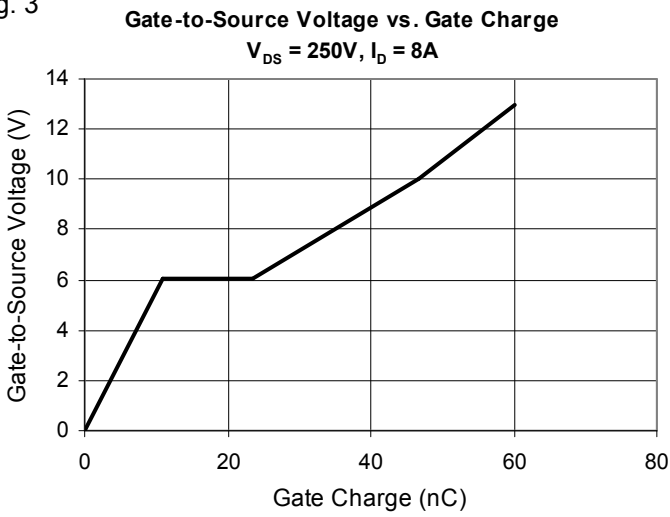
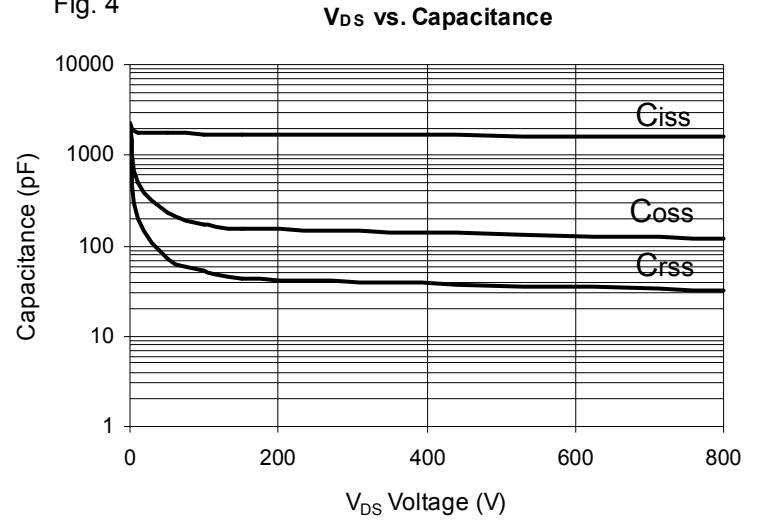
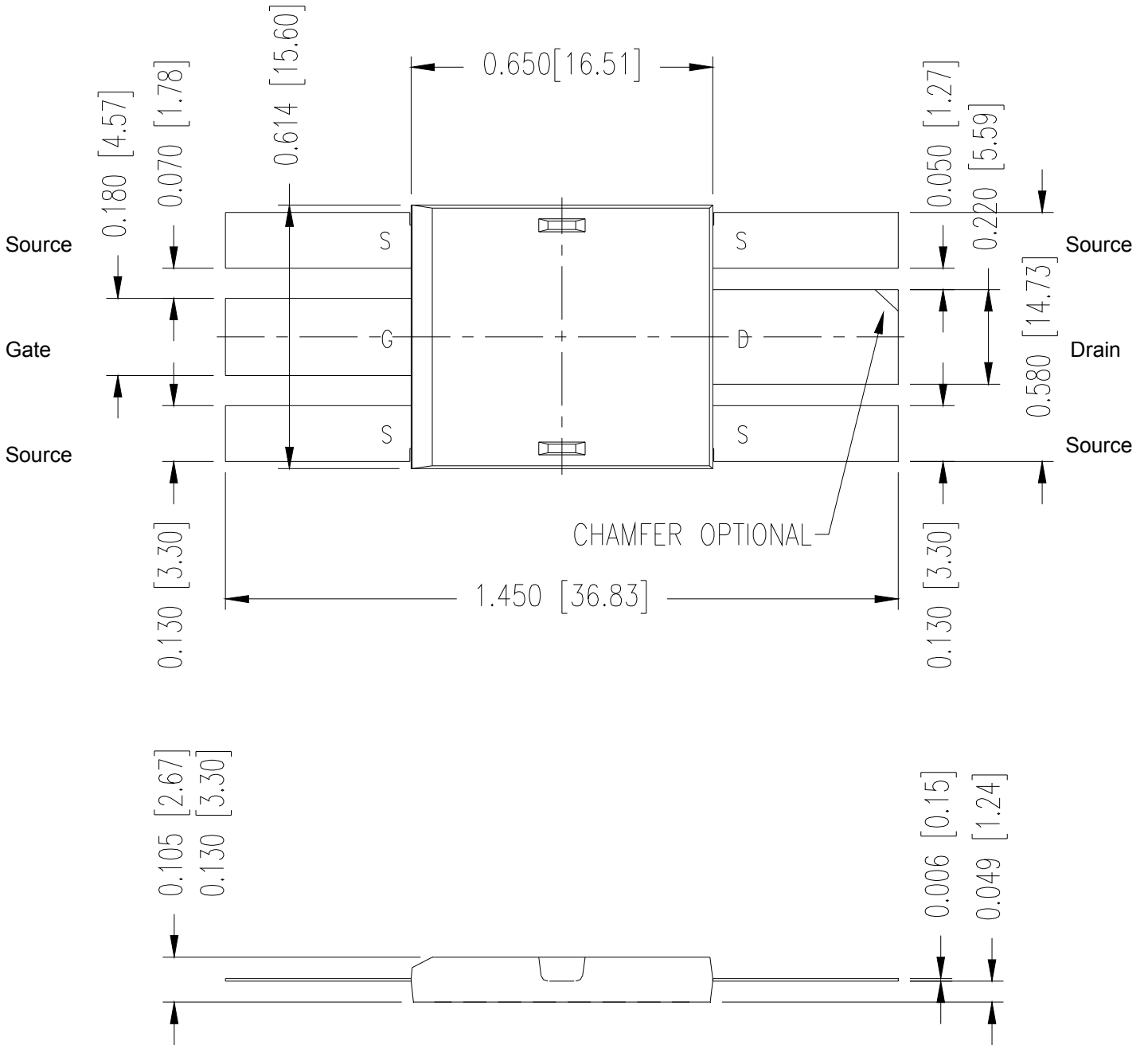

Fig. 4



**Fig. 5 Package Drawing**



**501N16A DE-SERIES SPICE Model**

The DE-SERIES SPICE Model is illustrated in Figure 6. The model is an expansion of the SPICE level 3 MOSFET model. It includes the stray inductive terms  $L_G$ ,  $L_S$  and  $L_D$ .  $R_d$  is the  $R_{DS(ON)}$  of the device,  $R_{ds}$  is the resistive leakage term. The output capacitance,  $C_{OSS}$ , and reverse transfer capacitance,  $C_{RSS}$  are modeled with reversed biased diodes. This provides a varactor type response necessary for a high power device model. The turn on delay and the turn off delay are adjusted via  $R_{on}$  and  $R_{off}$ .

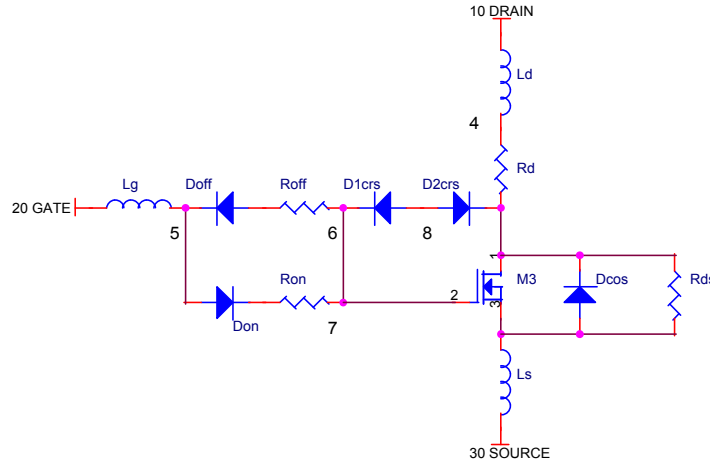

Figure 6 DE-SERIES SPICE Model

This SPICE model may be downloaded as a text file from the IXYS RF web site at [http://www.ixysrf.com/products/switch\\_mode.html](http://www.ixysrf.com/products/switch_mode.html)

<http://www.ixysrf.com/spice/de275-501n16a.html>

**Net List:**

```

SYM=POWMOSN
.SUBCKT 501N16A 10 20 30
* TERMINALS: D G S
* 500 Volt 16 Amp .38 ohm N-Channel Power MOSFET
* REVA 6-15-00
M1 1 2 3 3 DMOS L=1U W=1U
RON 5 6 .2
DON 6 2 D1
ROF 5 7 .2
DOF 2 7 D1
D1CRS 2 8 D2
D2CRS 1 8 D2
CGS 2 3 2.0N
RD 4 1 .38
DCOS 3 1 D3
RDS 1 3 5.0MEG
LS 3 30 .5N
LD 10 4 1N
LG 20 5 1N
.MODEL DMOS NMOS (LEVEL=3 VTO=3.0 KP=5.8)
.MODEL D1 D (IS=.5F CJO=10P BV=100 M=.5 VJ=.7 TT=1N RS=10M)
.MODEL D2 D (IS=.5F CJO=450P BV=500 M=.4 VJ=.6 TT=10N RS=10M)
.MODEL D3 D (IS=.5F CJO=900P BV=500 M=.3 VJ=.3 TT=400N RS=10M)
.ENDS
    
```

Doc #9200-0222 Rev 5  
© 2009 IXYS RF



An IXYS Company  
2401 Research Blvd., Suite 108  
Fort Collins, CO USA 80526  
970-493-1901 Fax: 970-493-1903  
Email: [sales@ixyscolorado.com](mailto:sales@ixyscolorado.com)  
Web: <http://www.ixyscolorado.com>

## X-ON Electronics

Largest Supplier of Electrical and Electronic Components

*Click to view similar products for [RF MOSFET Transistors](#) category:*

*Click to view products by [IXYS](#) manufacturer:*

Other Similar products are found below :

[MRF492](#) [MRFE8VP8600HR5](#) [ARF1511](#) [ARF465BG](#) [BF 2030 E6814](#) [BLF861A](#) [DU1215S](#) [DU28200M](#) [UF28100M](#) [DU2820S](#) [MRF426](#)  
[ARF468AG](#) [ARF468BG](#) [MAPHST0045](#) [DU2860U](#) [MRFE6VP5300NR1](#) [BF2040E6814HTSA1](#) [LET9060S](#) [MRF136Y](#) [BF999E6327HTSA1](#)  
[SD2931-12MR](#) [BF998E6327HTSA1](#) [AFT05MS006NT1](#) [MRF141](#) [MRF171](#) [MRF172](#) [MRF174](#) [SD2942](#) [QPD1020SR](#) [BF 1005S E6327](#)  
[MRF134](#) [MRF136](#) [MRF137](#) [MRF141G](#) [MRF151A](#) [MRF151G](#) [MRF157](#) [MRF158](#) [MRF160](#) [MRF166C](#) [MRF171A](#) [MRF177](#) [UF2840G](#)  
[TGF3021-SM](#) [ARF1510](#) [ARF448BG](#) [ARF449AG](#) [ARF466BG](#) [VRF150](#) [VRF3933](#)