

High Efficiency Thyristor

$$V_{RRM} = 1200 \text{ V}$$

$$I_{TAV} = 15 \text{ A}$$

$$V_T = 1.35 \text{ V}$$

Three Quadrants operation: QI - QIII
 1~ Triac

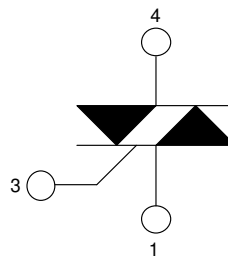
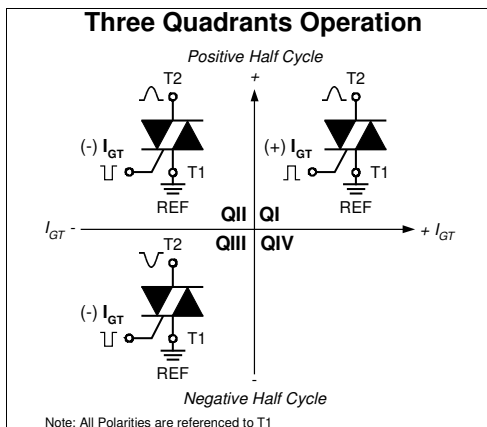
Part number

CLA30MT1200NPZ

Marking on Product: CLA30MT1200NPZ



Backside: anode/cathode



Features / Advantages:

- Triac for line frequency
- Three Quadrants Operation - QI - QIII
- Planar passivated chip
- Long-term stability of blocking currents and voltages

Applications:

- Line rectifying 50/60 Hz
- Softstart AC motor control
- DC Motor control
- Power converter
- AC power control
- Lighting and temperature control

Package: TO-263 (D2Pak-HV)

- Industry standard outline
- RoHS compliant
- Epoxy meets UL 94V-0
- High creepage distance between terminals

Disclaimer Notice

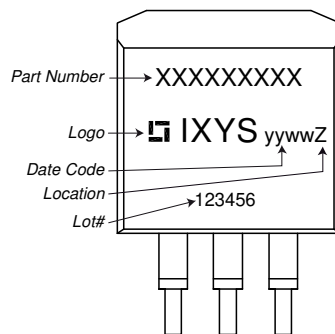
Information furnished is believed to be accurate and reliable. However, users should independently evaluate the suitability of and test each product selected for their own applications. Littelfuse products are not designed for, and may not be used in, all applications. Read complete Disclaimer Notice at www.littelfuse.com/disclaimer-electronics.



Rectifier			Ratings			
Symbol	Definition	Conditions	min.	typ.	max.	Unit
$V_{RSM/DSM}$	max. non-repetitive reverse/forward blocking voltage	$T_{VJ} = 25^{\circ}C$			1300	V
$V_{RRM/DRM}$	max. repetitive reverse/forward blocking voltage	$T_{VJ} = 25^{\circ}C$			1200	V
I_{RD}	reverse current, drain current	$V_{R/D} = 1200 V$	$T_{VJ} = 25^{\circ}C$		10	μA
		$V_{R/D} = 1200 V$	$T_{VJ} = 125^{\circ}C$		1.5	mA
V_T	forward voltage drop	$I_T = 15 A$	$T_{VJ} = 25^{\circ}C$		1.35	V
		$I_T = 30 A$			1.68	V
		$I_T = 15 A$	$T_{VJ} = 125^{\circ}C$		1.35	V
		$I_T = 30 A$			1.79	V
I_{TAV}	average forward current	$T_C = 120^{\circ}C$	$T_{VJ} = 150^{\circ}C$		15	A
I_{RMS}	RMS forward current per phase	180° sine			33	A
V_{T0}	threshold voltage	} for power loss calculation only	$T_{VJ} = 150^{\circ}C$		0.89	V
r_T	slope resistance				30	m Ω
R_{thJC}	thermal resistance junction to case				0.95	K/W
R_{thCH}	thermal resistance case to heatsink			0.3		K/W
P_{tot}	total power dissipation		$T_C = 25^{\circ}C$		130	W
I_{TSM}	max. forward surge current	$t = 10 \text{ ms}; (50 \text{ Hz}), \text{ sine}$	$T_{VJ} = 45^{\circ}C$		170	A
		$t = 8,3 \text{ ms}; (60 \text{ Hz}), \text{ sine}$	$V_R = 0 V$		185	A
		$t = 10 \text{ ms}; (50 \text{ Hz}), \text{ sine}$	$T_{VJ} = 150^{\circ}C$		145	A
		$t = 8,3 \text{ ms}; (60 \text{ Hz}), \text{ sine}$	$V_R = 0 V$		155	A
I^2t	value for fusing	$t = 10 \text{ ms}; (50 \text{ Hz}), \text{ sine}$	$T_{VJ} = 45^{\circ}C$		145	A ² s
		$t = 8,3 \text{ ms}; (60 \text{ Hz}), \text{ sine}$	$V_R = 0 V$		140	A ² s
		$t = 10 \text{ ms}; (50 \text{ Hz}), \text{ sine}$	$T_{VJ} = 150^{\circ}C$		105	A ² s
		$t = 8,3 \text{ ms}; (60 \text{ Hz}), \text{ sine}$	$V_R = 0 V$		100	A ² s
C_J	junction capacitance	$V_R = 400 V \quad f = 1 \text{ MHz}$	$T_{VJ} = 25^{\circ}C$		9	pF
P_{GM}	max. gate power dissipation	$t_p = 30 \mu s$	$T_C = 150^{\circ}C$		5	W
		$t_p = 300 \mu s$			1	W
P_{GAV}	average gate power dissipation				0.2	W
$(di/dt)_{cr}$	critical rate of rise of current	$T_{VJ} = 150^{\circ}C; f = 50 \text{ Hz}$	repetitive, $I_T = 45 A$		150	A/ μs
		$t_p = 200 \mu s; di_G/dt = 0.3 A/\mu s;$ $I_G = 0.3 A; V = \frac{2}{3} V_{DRM}$	non-repet., $I_T = 15 A$		500	A/ μs
$(dv/dt)_{cr}$	critical rate of rise of voltage	$V = \frac{2}{3} V_{DRM}$	$T_{VJ} = 150^{\circ}C$		500	V/ μs
		$R_{GK} = \infty$; method 1 (linear voltage rise)				
V_{GT}	gate trigger voltage	$V_D = 6 V$	$T_{VJ} = 25^{\circ}C$		1.3	V
			$T_{VJ} = -40^{\circ}C$		1.6	V
I_{GT}	gate trigger current	$V_D = 6 V$	$T_{VJ} = 25^{\circ}C$		± 40	mA
			$T_{VJ} = -40^{\circ}C$		± 60	mA
V_{GD}	gate non-trigger voltage	$V_D = \frac{2}{3} V_{DRM}$	$T_{VJ} = 150^{\circ}C$		0.2	V
I_{GD}	gate non-trigger current				± 1	mA
I_L	latching current	$t_p = 10 \mu s$	$T_{VJ} = 25^{\circ}C$		70	mA
		$I_G = 0.3 A; di_G/dt = 0.3 A/\mu s$				
I_H	holding current	$V_D = 6 V \quad R_{GK} = \infty$	$T_{VJ} = 25^{\circ}C$		50	mA
t_{gd}	gate controlled delay time	$V_D = \frac{1}{2} V_{DRM}$	$T_{VJ} = 25^{\circ}C$		2	μs
		$I_G = 0.3 A; di_G/dt = 0.3 A/\mu s$				
t_q	turn-off time	$V_R = 100 V; I_T = 15 A; V = \frac{2}{3} V_{DRM}$ $di/dt = 10 A/\mu s \quad dv/dt = 20 V/\mu s \quad t_p = 200 \mu s$	$T_{VJ} = 125^{\circ}C$		150	μs

Package TO-263 (D2Pak-HV)		Ratings				
Symbol	Definition	Conditions	min.	typ.	max.	Unit
I_{RMS}	RMS current	per terminal			35	A
T_{VJ}	virtual junction temperature		-40		150	°C
T_{op}	operation temperature		-40		125	°C
T_{stg}	storage temperature		-40		150	°C
Weight				1.5		g
F_C	mounting force with clip		20		60	N
$d_{Spp/App}$	creepage distance on surface / striking distance through air	terminal to terminal	4.2			mm
$d_{Spb/Apb}$		terminal to backside	4.7			mm

Product Marking



Part description

C = Thyristor (SCR)
 L = High Efficiency Thyristor
 A = (up to 1200V)
 30 = Current Rating [A]
 MT = 1~ Triac
 1200 = Reverse Voltage [V]
 N = Three Quadrants operation: QI - QIII
 PZ = TO-263AB (D2Pak) (2HV)

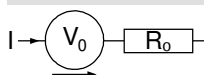
Ordering	Ordering Number	Marking on Product	Delivery Mode	Quantity	Code No.
Standard	CLA30MT1200NPZ-TRL	CLA30MT1200NPZ	Tape & Reel	800	516960
Alternative	CLA30MT1200NPZ-TUB	CLA30MT1200NPZ	Tube	50	525255

Similar Part	Package	Voltage class
CLA30MT1200NPB	TO-220AB (3)	1200

Equivalent Circuits for Simulation

* on die level

$T_{VJ} = 150^{\circ}\text{C}$

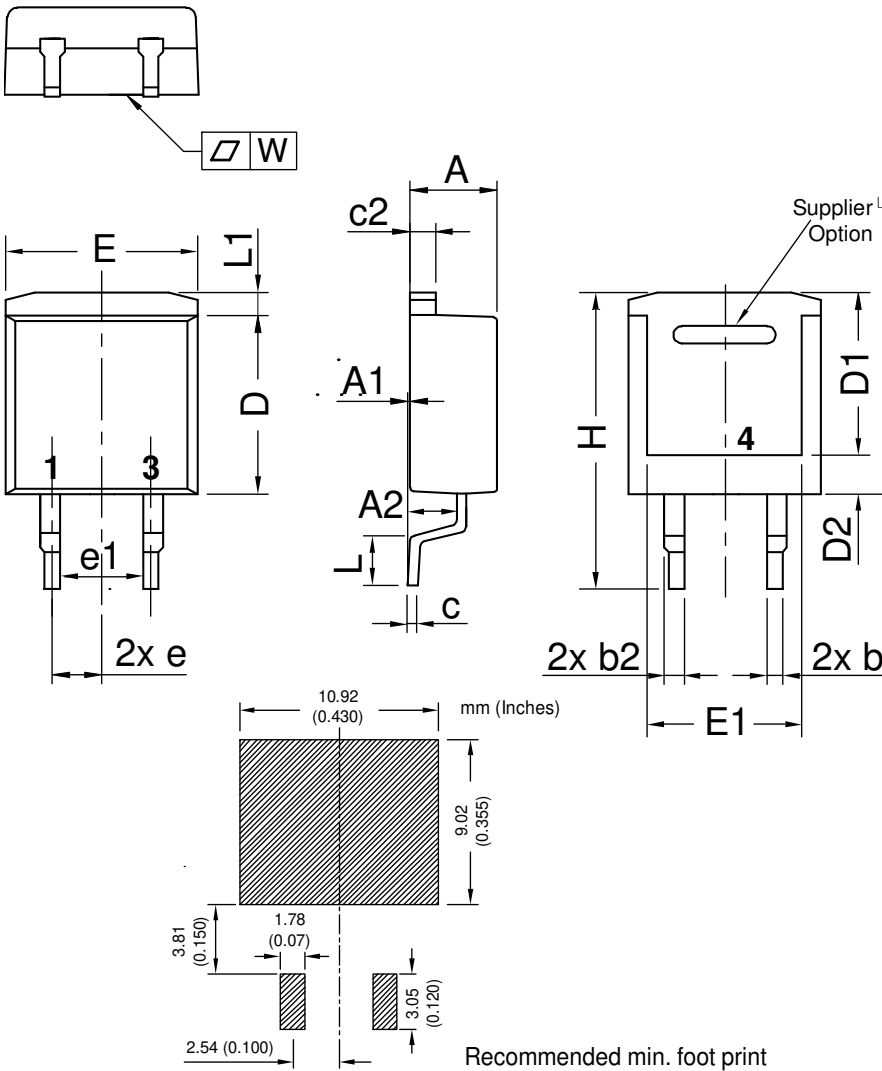


Thyristor

$V_{0\ max}$	threshold voltage	0.89	V
$R_{0\ max}$	slope resistance *	27	mΩ

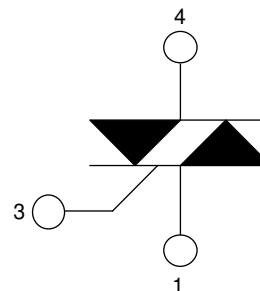


Outlines TO-263 (D2Pak-HV)



Dim.	Millimeter		Inches	
	min	max	min	max
A	4.06	4.83	0.160	0.190
A1	typ. 0.10		typ. 0.004	
A2	2.41		0.095	
b	0.51	0.99	0.020	0.039
b2	1.14	1.40	0.045	0.055
c	0.40	0.74	0.016	0.029
c2	1.14	1.40	0.045	0.055
D	8.38	9.40	0.330	0.370
D1	8.00	8.89	0.315	0.350
D2	2.3		0.091	
E	9.65	10.41	0.380	0.410
E1	6.22	8.50	0.245	0.335
e	2,54 BSC		0,100 BSC	
e1	4.28		0.169	
H	14.61	15.88	0.575	0.625
L	1.78	2.79	0.070	0.110
L1	1.02	1.68	0.040	0.066
W	typ. 0.02	0.040	typ. 0.0008	0.002

All dimensions conform with and/or within JEDEC standard.



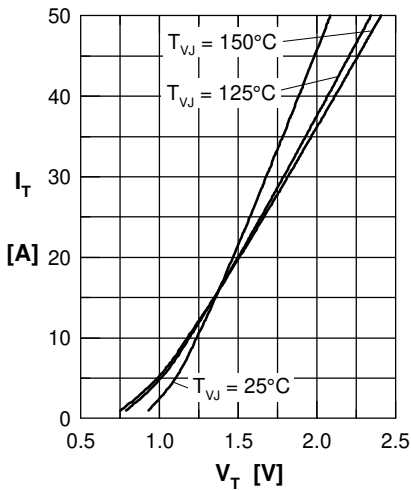
Thyristor


Fig. 1 Forward characteristics

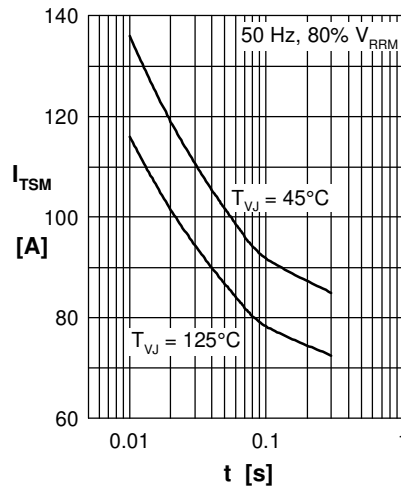


Fig. 2 Surge overload current

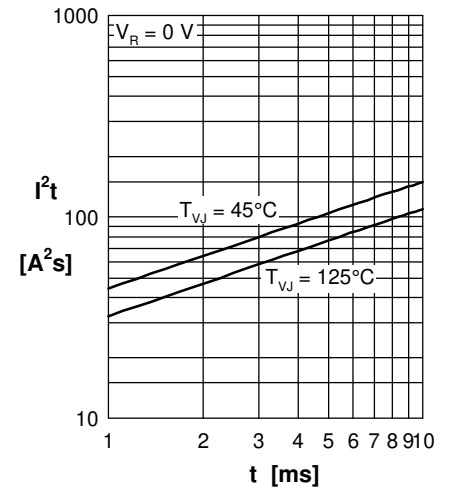
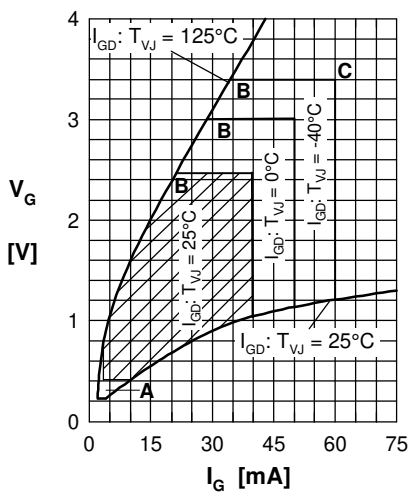

 Fig. 3 I^2t versus time (1-10 ms)


Fig. 4 Gate trigger characteristics

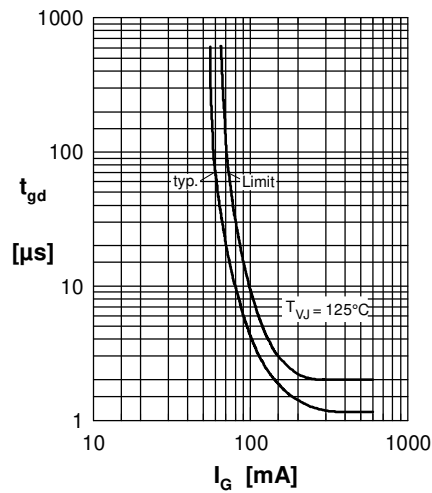


Fig. 5 Gate controlled delay time

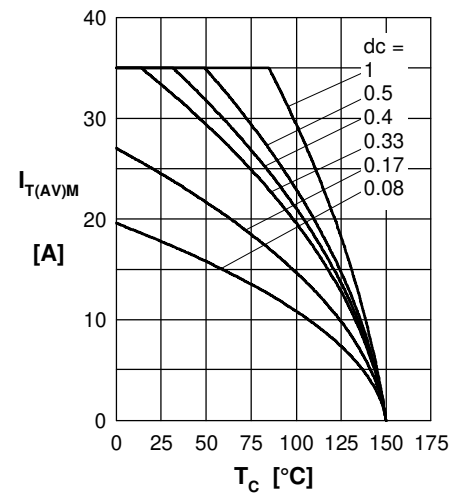


Fig. 6 Max. forward current at case temperature

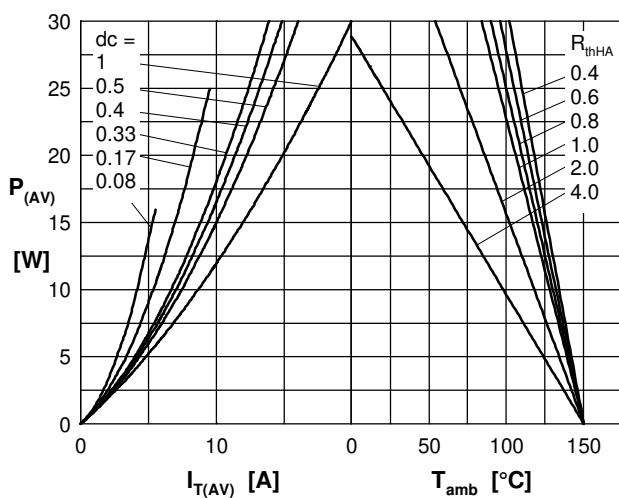
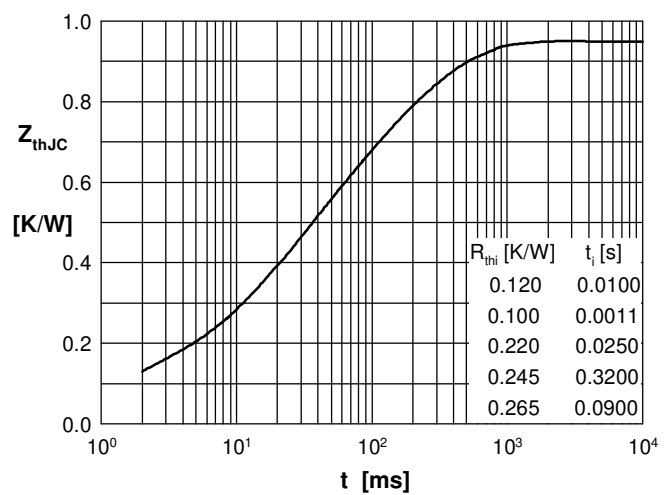

 Fig. 7a Power dissipation versus direct output current
 Fig. 7b and ambient temperature


Fig. 8 Transient thermal impedance

X-ON Electronics

Largest Supplier of Electrical and Electronic Components

Click to view similar products for [Triacs](#) category:

Click to view products by [IXYS](#) manufacturer:

Other Similar products are found below :

[T2035H-6G](#) [BT137-600-0Q](#) [Z0409MF0AA2](#) [Z0109NA 2AL2](#) [ACST1635T-8FP](#) [BCR20RM-30LA#B00](#) [CMA60MT1600NHR](#) [NTE5611](#)
[NTE5612](#) [NTE5613](#) [NTE5621](#) [NTE5623](#) [NTE5629](#) [NTE5638-08](#) [NTE5688](#) [NTE5689](#) [NTE5690](#) [T1235T-8I](#) [BTA312-600CT.127](#) [T1210T-](#)
[8G-TR](#) [Z0109NN0,135](#) [T2535T-8I](#) [T2535T-8T](#) [TN4050-12WL](#) [MAC4DLM-1G](#) [BT137-600E,127](#) [BT137X-600D](#) [BT148W-600R,115](#)
[BT258-500R,127](#) [BTA08-800BW3G](#) [BTA140-800,127](#) [BTA30-600CW3G](#) [BTA30-600CW3G](#) [BTB08-800BW3G](#) [BTB16-600CW3G](#)
[BTB16-600CW3G](#) [Z0410MF0AA2](#) [Z0109MN,135](#) [T825T-6I](#) [T1635T-6I](#) [T1220T-6I](#) [NTE5638](#) [TYN612MRG](#) [TYN1225RG](#) [TPDV840RG](#)
[ACST1235-8FP](#) [ACS302-6T3-TR](#) [BT134-600D,127](#) [BT134-600G,127](#) [BT136X-600E,127](#)