



Parameter	Rating	Units
Blocking Voltage	350	V_p
Load Current	120	mA_{rms} / mA_{DC}
On-Resistance (max)	30	Ω
LED Current to operate	2	mA

Features

- 1500V_{rms} Input/Output Isolation
- Small 8-Pin SOIC Package
- TTL/CMOS Compatible input
- Arc-Free With No Snubbing Circuits
- No EMI/RFI Generation
- Immune to radiated EM fields
- SMD Pick & Place, Wave Solderable
- Tape & Reel Version Available

Applications

- Telecommunication
- Security
 - Passive Infrared Detectors (PIR)
 - Data Signalling
 - Sensor Circuitry
- Instrumentation
 - Multiplexers
 - Data Acquisition
 - Electronic Switching
 - I/O Subsystems
- Medical Equipment—Patient/Equipment Isolation
- Aerospace
- Industrial Controls

Pin Configuration

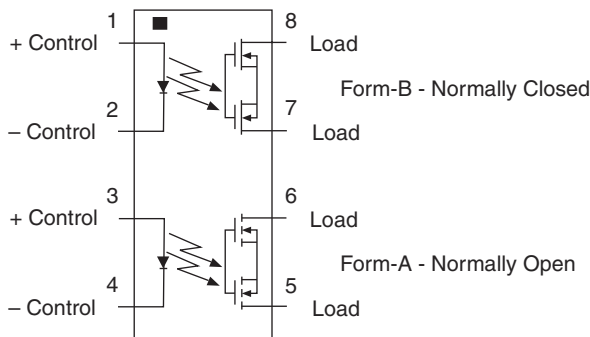

Description

The CPC2330N is a miniature device with two independent solid state relays, one normally open (1-Form-A) and the other normally closed (1-Form-B), in an 8-pin SOIC package with 1500V_{rms} of input to output isolation.

The optically coupled outputs, which use IXYS Integrated Circuits Division's patented OptoMOS architecture, are controlled by a highly efficient GaAIAs infrared LED.

Using IXYS Integrated Circuits Division's state of the art, double-molded vertical construction packaging, the CPC2330N is ideal for replacing larger less-reliable reed and electromechanical relays.

Approvals

- UL Recognized Component: File E76270
- EN/IEC 60950-1 Certified Component: TUV Certificate B 09 07 49410 004

Ordering Information

Part #	Description
CPC2330N	8-Pin SOIC (50/tube)
CPC2330NTR	8-Pin SOIC (2000/reel)

Switching Characteristics of Normally Open Devices

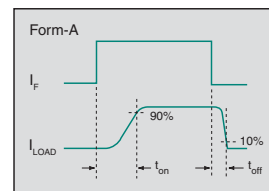

Switching Characteristics of Normally Closed Devices

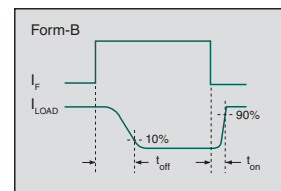

Absolute Maximum Ratings @ 25°C

Parameter	Ratings	Units
Blocking Voltage	350	V _P
Reverse Input Voltage	5	V
Input Control Current Peak (10ms)	50	mA
	1	A
Total Power Dissipation ¹	600	mW
Isolation Voltage, Input to Output	1500	V _{rms}
ESD Rating, Human Body Model	8	kV
Operational Temperature	-40 to +85	°C
Storage Temperature	-40 to +125	°C
Soldering Temperature (10 Seconds)	260	°C

¹ Derate linearly 5.0 mW / °C

Absolute Maximum Ratings are stress ratings. Stresses in excess of these ratings can cause permanent damage to the device. Functional operation of the device at conditions beyond those indicated in the operational sections of this data sheet is not implied.

Electrical Characteristics @ 25°C

Parameter	Conditions	Symbol	Min	Typ	Max	Units	
Output Characteristics							
Load Current Continuous ¹	(Form-A) I _F =2mA (Form-B) I _F =0mA	I _L	-	-	120	mA _{rms} / mA _{DC}	
	t = 10ms	I _{LPK}	-	-	±350	mA _P	
On-Resistance ²	I _L =120mA	R _{ON}	-	-	30	Ω	
Switching Speeds Turn-On Turn-Off	I _F =5mA, V _L =10V	t _{on}	-	-	3	ms	
		t _{off}	-	-	3		
Off-State Leakage Current	V _L =350V _P	I _{LEAK}	-	-	1	μA	
Output Capacitance	V _L =50V, f=1MHz	C _{OUT}	-	-	-	pF	
	(Form-A) I _F =0mA						9
	(Form-B) I _F =5mA						6
Input Characteristics							
Input Control Current to Activate ³	I _L =120mA	I _F	-	-	2	mA	
Input Control Current to Deactivate	-	I _F	0.1	-	-	mA	
Input Voltage Drop	I _F =5mA	V _F	0.9	1.2	1.4	V	
Reverse Input Current	V _R =5V	I _R	-	-	10	μA	
Common Characteristics							
Capacitance, Input to Output	-	-	-	1	-	pF	

¹ Load current derates linearly from 120mA @ 25°C to 60mA @ 85°C, and must be derated for both poles operating simultaneously.

² Measurement taken within 1 second of on-time.

³ For applications requiring high temperature operation (greater than 60°C) an LED drive current of 4mA is recommended.

FORM-A & FORM-B PERFORMANCE DATA*

Typical LED Forward Voltage Drop
(N=50, $I_F=5\text{mA}$, $T_A=25^\circ\text{C}$)

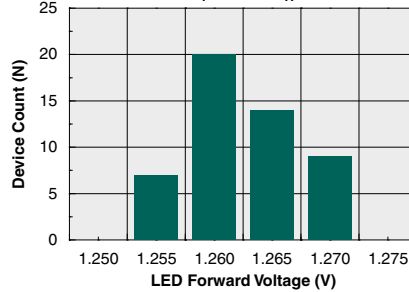

Typical LED Forward Voltage Drop vs. Temperature

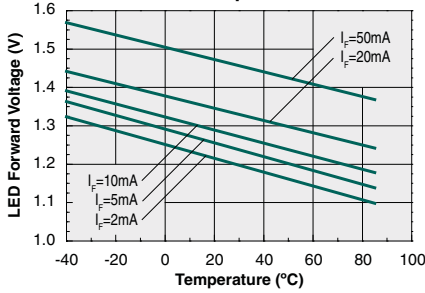

Maximum Load Current vs. Temperature

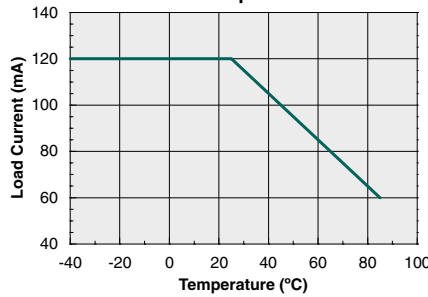

Energy Rating Curve
($T_A=25^\circ\text{C}$)

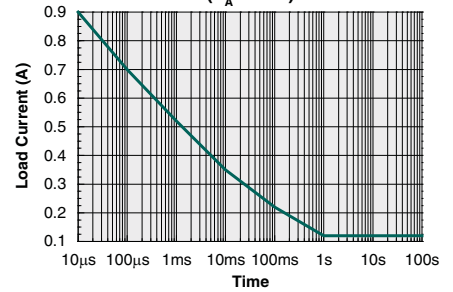

FORM-A PERFORMANCE DATA*

Typical I_F for Switch Operation
(N=50, $I_L=120\text{mA}$, $T_A=25^\circ\text{C}$)

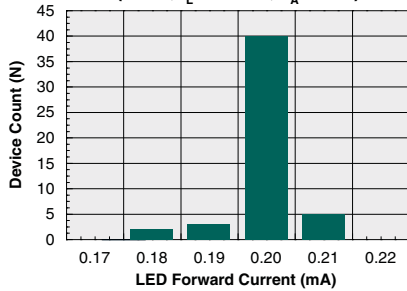

Typical Turn-On Time
(N=50, $I_F=5\text{mA}$, $I_L=60\text{mA}$, $T_A=25^\circ\text{C}$)

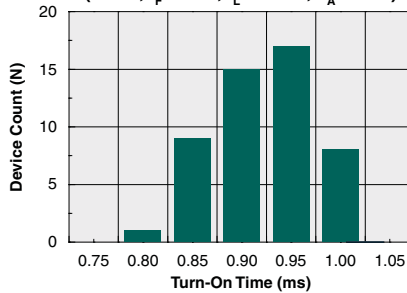

Typical Turn-Off Time
(N=50, $I_F=5\text{mA}$, $I_L=60\text{mA}$, $T_A=25^\circ\text{C}$)

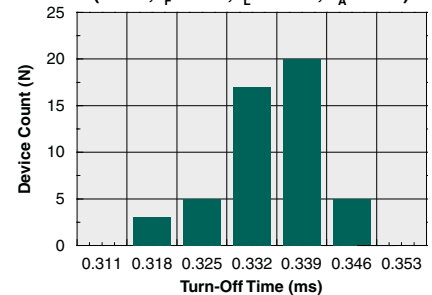

Typical On-Resistance Distribution
(N=50, $I_F=2\text{mA}$, $I_L=120\text{mA}$, $T_A=25^\circ\text{C}$)

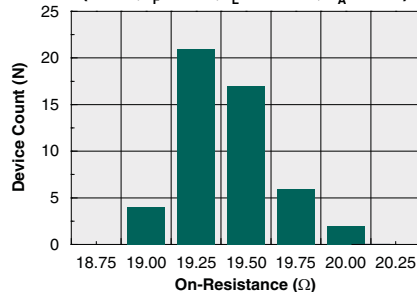

Typical Blocking Voltage Distribution
(N=50, $I_F=0\text{mA}$, $T_A=25^\circ\text{C}$)

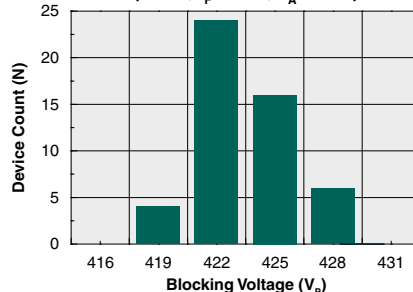

*The Performance Data shown in the graphs above is typical of device performance. For guaranteed parameters not indicated in the written specifications, please contact our application department.

FORM-A PERFORMANCE DATA (Cont.)*

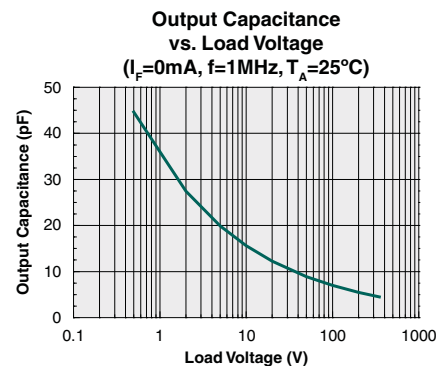
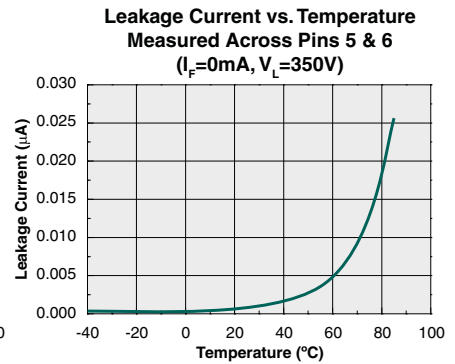
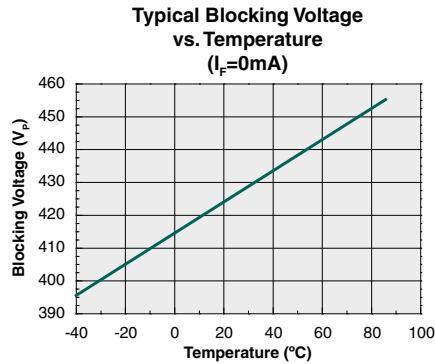
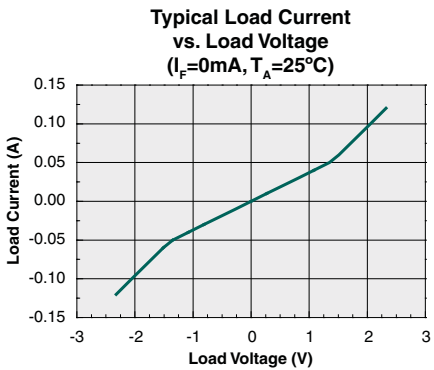
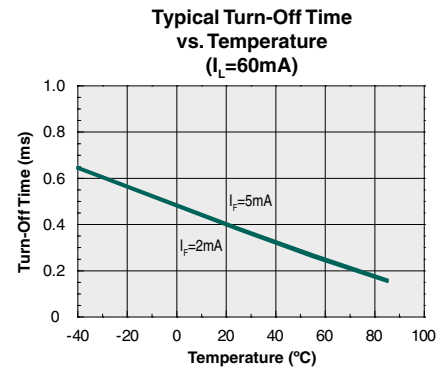
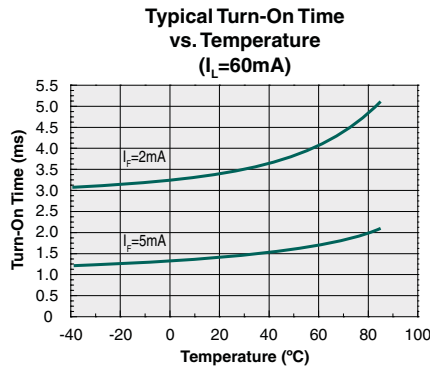
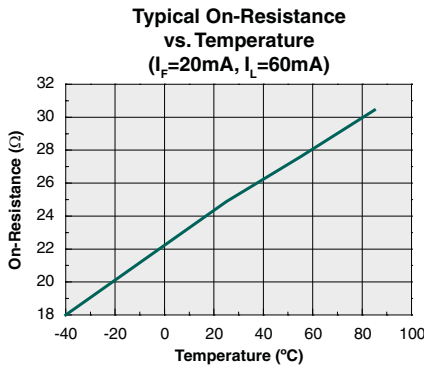
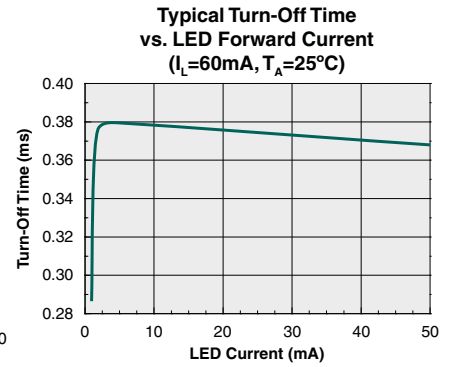
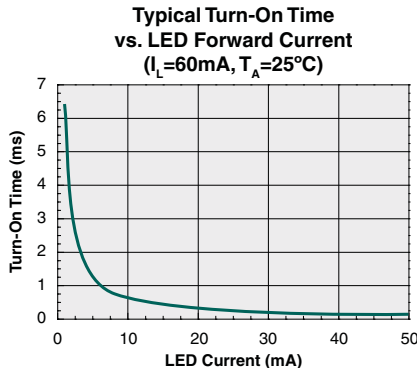
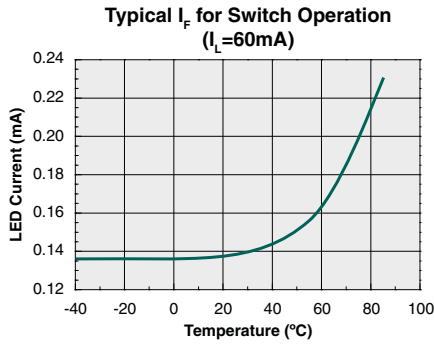

*The Performance Data shown in the graphs above is typical of device performance. For guaranteed parameters not indicated in the written specifications, please contact our application department.

FORM-B PERFORMANCE DATA*

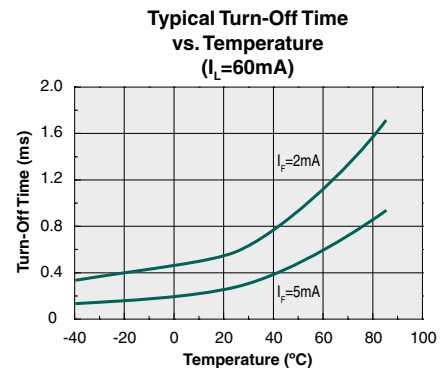
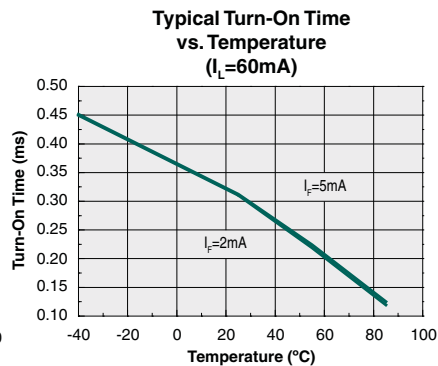
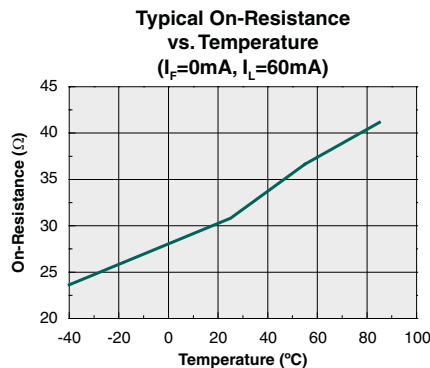
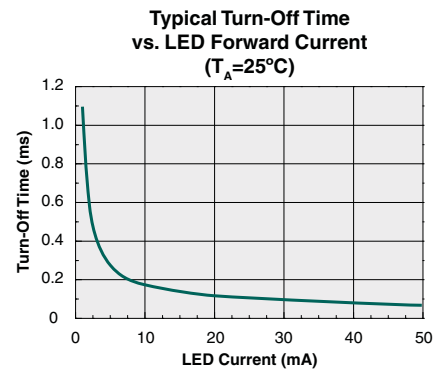
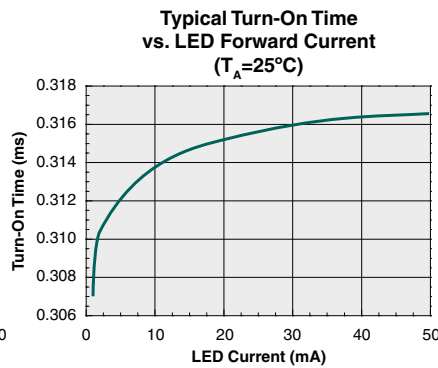
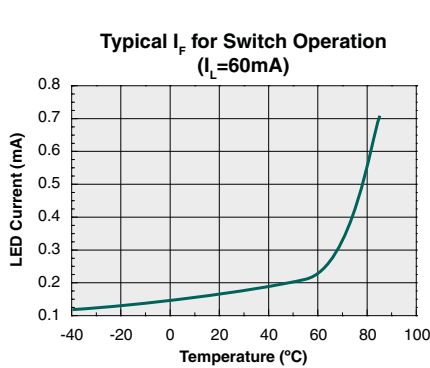
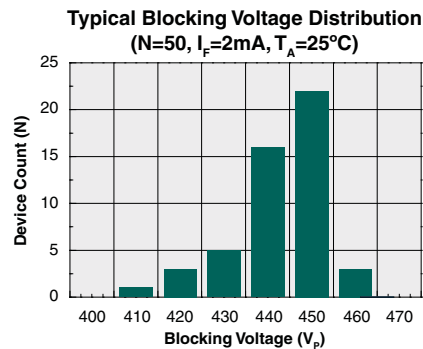
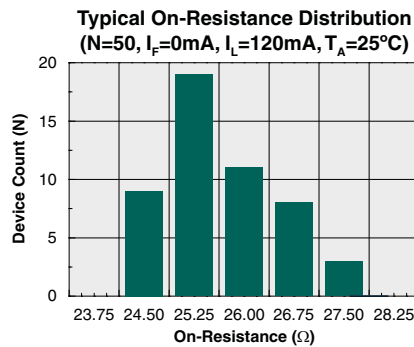
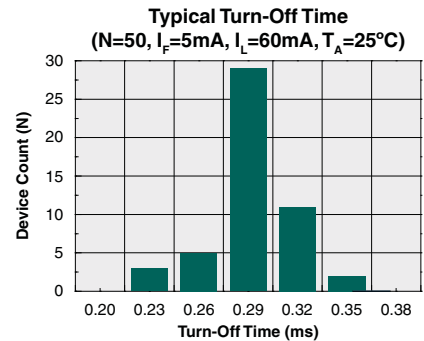
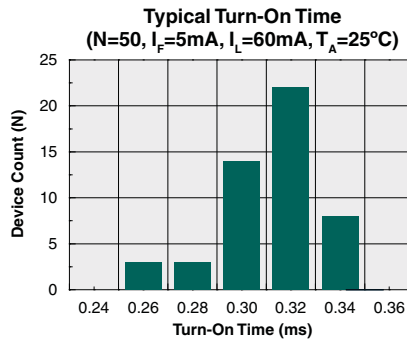
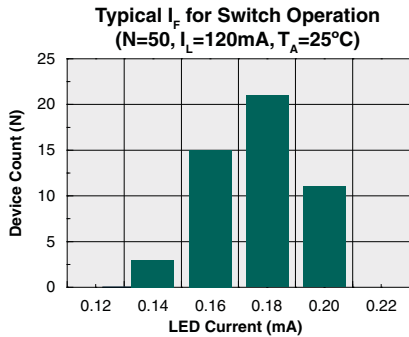

*The Performance Data shown in the graphs above is typical of device performance. For guaranteed parameters not indicated in the written specifications, please contact our application department.

FORM-B PERFORMANCE DATA (Cont.)*

Typical Load Current vs. Load Voltage
($I_F=0\text{mA}$, $T_A=25^\circ\text{C}$)

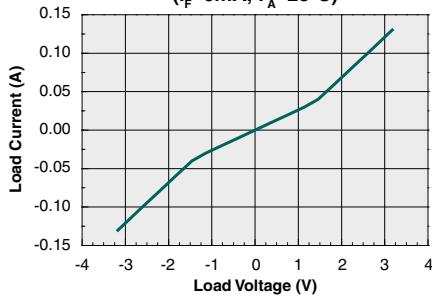

Typical Blocking Voltage vs. Temperature
($I_F=5\text{mA}$)

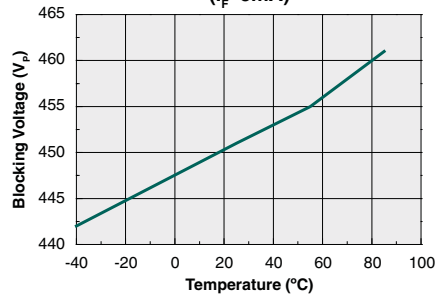

Leakage Current vs. Temperature Measured Across Pins 7 & 8
($I_F=5\text{mA}$, $V_L=350\text{V}$)

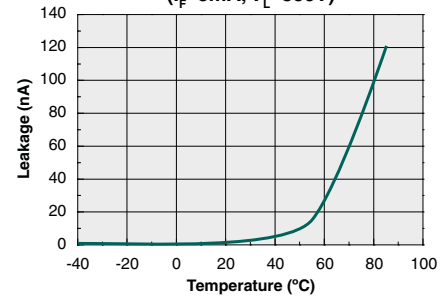

Output Capacitance vs. Load Voltage
($I_F=2\text{mA}$, $f=1\text{MHz}$, $T_A=25^\circ\text{C}$)

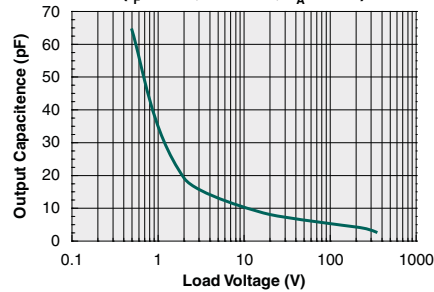

*The Performance Data shown in the graphs above is typical of device performance. For guaranteed parameters not indicated in the written specifications, please contact our application department.

Manufacturing Information

Moisture Sensitivity



All plastic encapsulated semiconductor packages are susceptible to moisture ingress. IXYS Integrated Circuits Division classified all of its plastic encapsulated devices for moisture sensitivity according to the latest version of the joint industry standard, **IPC/JEDEC J-STD-020**, in force at the time of product evaluation. We test all of our products to the maximum conditions set forth in the standard, and guarantee proper operation of our devices when handled according to the limitations and information in that standard as well as to any limitations set forth in the information or standards referenced below.

Failure to adhere to the warnings or limitations as established by the listed specifications could result in reduced product performance, reduction of operable life, and/or reduction of overall reliability.

This product carries a **Moisture Sensitivity Level (MSL) rating** as shown below, and should be handled according to the requirements of the latest version of the joint industry standard **IPC/JEDEC J-STD-033**.

Device	Moisture Sensitivity Level (MSL) Rating
CPC2330N	MSL 3

ESD Sensitivity



This product is **ESD Sensitive**, and should be handled according to the industry standard **JESD-625**.

Reflow Profile

This product has a maximum body temperature and time rating as shown below. All other guidelines of **J-STD-020** must be observed.

Device	Maximum Temperature x Time
CPC2330N	260°C for 30 seconds

Board Wash

IXYS Integrated Circuits Division recommends the use of no-clean flux formulations. However, board washing to remove flux residue is acceptable. Since IXYS Integrated Circuits Division employs the use of silicone coating as an optical waveguide in many of its optically isolated products, the use of a short drying bake could be necessary if a wash is used after solder reflow processes. Chlorine- or Fluorine-based solvents or fluxes should not be used. Cleaning methods that employ ultrasonic energy should not be used.



Mechanical Dimensions

CPC2330N

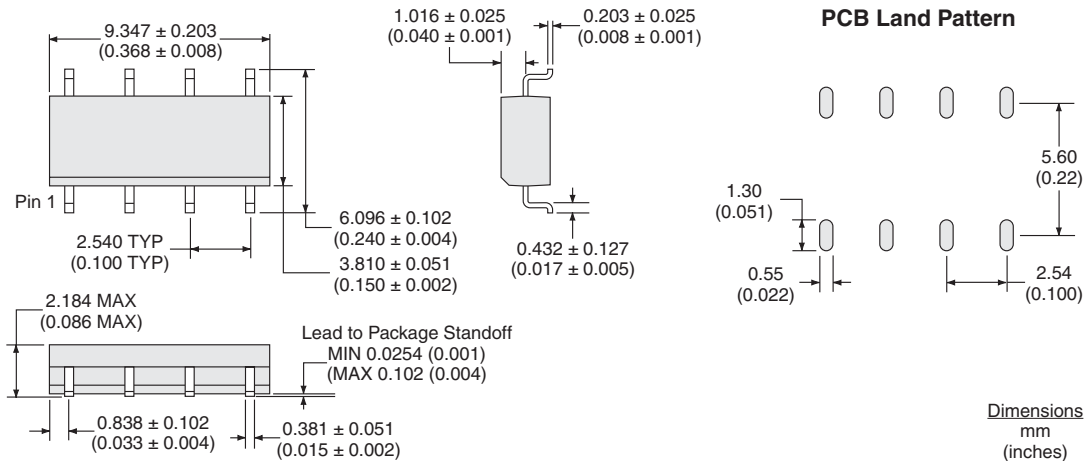

CPC2330NTR Tape & Reel

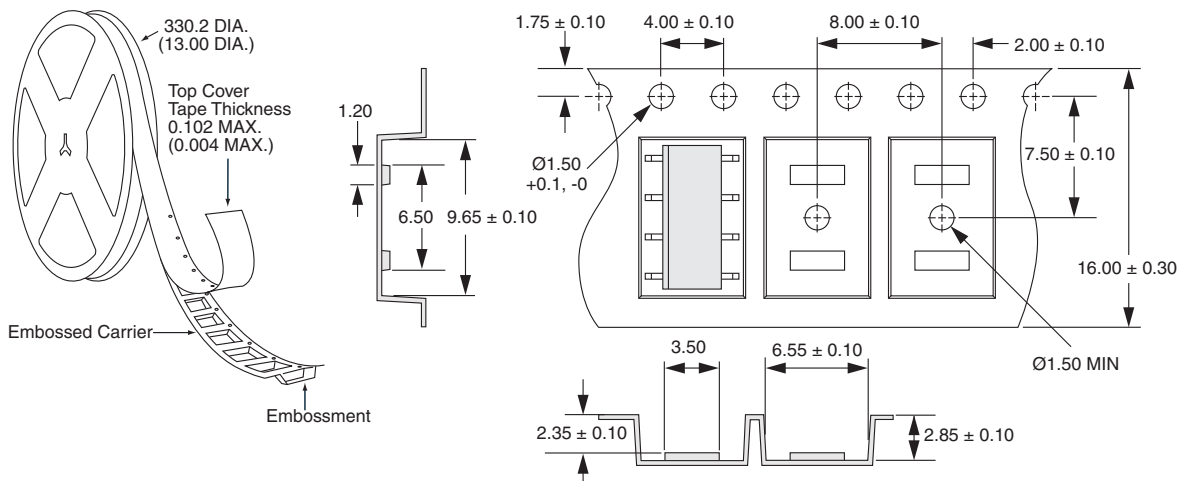

NOTES:

1. All dimensions in millimeters
2. 10 sprocket hole pitch cumulative tolerance ± 0.20.
3. Carrier camber is within 1mm in 250mm.
4. Tape material : Black Conductive Polystyrene Alloy.
5. All dimensions meet EIA-481-C requirements.
6. Thickness : 0.30 ± 0.05mm.
7. Component load per 13" reel : 2000 pcs.

For additional information please visit our website at: www.ixysic.com

IXYS Integrated Circuits Division makes no representations or warranties with respect to the accuracy or completeness of the contents of this publication and reserves the right to make changes to specifications and product descriptions at any time without notice. Neither circuit patent licenses nor indemnity are expressed or implied. Except as set forth in IXYS Integrated Circuits Division's Standard Terms and Conditions of Sale, IXYS Integrated Circuits Division assumes no liability whatsoever, and disclaims any express or implied warranty, relating to its products including, but not limited to, the implied warranty of merchantability, fitness for a particular purpose, or infringement of any intellectual property right.

The products described in this document are not designed, intended, authorized or warranted for use as components in systems intended for surgical implant into the body, or in other applications intended to support or sustain life, or where malfunction of IXYS Integrated Circuits Division's product may result in direct physical harm, injury, or death to a person or severe property or environmental damage. IXYS Integrated Circuits Division reserves the right to discontinue or make changes to its products at any time without notice.

X-ON Electronics

Largest Supplier of Electrical and Electronic Components

Click to view similar products for [Solid State Relays - PCB Mount](#) category:

Click to view products by [IXYS](#) manufacturer:

Other Similar products are found below :

[M86F-2W](#) [M90F-2Y](#) [G2-1A07-ST](#) [G2-1A07-TT](#) [G2-1B02-TT](#) [G2-DA06-ST](#) [923812OCAS](#) [PLA134S](#) [DS11-1005](#) [AQH3213J](#) [AQV212J](#)
[AQY412EHAJ](#) [EFR1200480A150](#) [901-7](#) [LCA220](#) [LCB110S](#) [1618400-5](#) [SR75-1ST](#) [AQH2213AJ](#) [AQV112KLJ](#) [AQV212AJ](#) [AQV212SXJ](#)
[AQV238AD01](#) [AQW414TS](#) [AQY221N2SYD01](#) [AQY221R2VJ](#) [AQY275AXJ](#) [AQY414SXE01](#) [G2-1A02-ST](#) [G2-1A03-ST](#) [G2-1A03-TT](#)
[G2-1A05-ST](#) [G2-1A06-TT](#) [G2-1A23-TT](#) [G2-1B01-ST](#) [G2-1B01-TT](#) [G2-1B02-ST](#) [G2-DA03-ST](#) [G2-DA03-TT](#) [G2-DA06-TT](#) [CPC1333GR](#)
[3-1617776-2](#) [CTA2425](#) [TLP3131\(F\)](#) [LBA110S](#) [LBB110S](#) [LCA110LSTR](#) [LCB126S](#) [WPPM-0626D](#) [WPPM-3526D](#)