

# Standard Rectifier

$$V_{RRM} = 2 \times 1600 \text{ V}$$

$$I_{FAV} = 30 \text{ A}$$

$$V_F = 1.23 \text{ V}$$

Phase leg

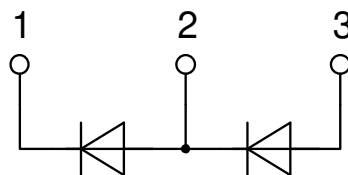
Part number

**DMA30P1600HR**



Backside: isolated

 E72873



### Features / Advantages:

- Planar passivated chips
- Very low leakage current
- Very low forward voltage drop
- Improved thermal behaviour

### Applications:

- Diode for main rectification
- For single and three phase bridge configurations

### Package: ISO247

- Isolation Voltage: 3600 V~
- Industry standard outline
- RoHS compliant
- Epoxy meets UL 94V-0
- Soldering pins for PCB mounting
- Backside: DCB ceramic
- Reduced weight
- Advanced power cycling

### Disclaimer Notice

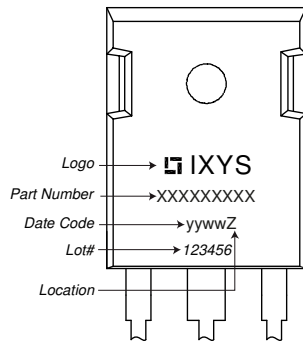
Information furnished is believed to be accurate and reliable. However, users should independently evaluate the suitability of and test each product selected for their own applications. Littelfuse products are not designed for, and may not be used in, all applications. Read complete Disclaimer Notice at [www.littelfuse.com/disclaimer-electronics](http://www.littelfuse.com/disclaimer-electronics).

Rectifier				Ratings			
Symbol	Definition	Conditions	min.	typ.	max.	Unit	
$V_{RSM}$	max. non-repetitive reverse blocking voltage	$T_{VJ} = 25^{\circ}C$			1700	V	
$V_{RRM}$	max. repetitive reverse blocking voltage	$T_{VJ} = 25^{\circ}C$			1600	V	
$I_R$	reverse current	$V_R = 1600\text{ V}$	$T_{VJ} = 25^{\circ}C$		40	$\mu A$	
		$V_R = 1600\text{ V}$	$T_{VJ} = 150^{\circ}C$		1.5	mA	
$V_F$	forward voltage drop	$I_F = 30\text{ A}$	$T_{VJ} = 25^{\circ}C$		1.28	V	
		$I_F = 60\text{ A}$			1.57	V	
		$I_F = 30\text{ A}$	$T_{VJ} = 150^{\circ}C$		1.23	V	
		$I_F = 60\text{ A}$			1.63	V	
$I_{FAV}$	average forward current	$T_C = 105^{\circ}C$ 180° sine	$T_{VJ} = 175^{\circ}C$		30	A	
$V_{F0}$	threshold voltage	} for power loss calculation only	$T_{VJ} = 175^{\circ}C$		0.82	V	
$r_F$	slope resistance				13.5	m $\Omega$	
$R_{thJC}$	thermal resistance junction to case				1.3	K/W	
$R_{thCH}$	thermal resistance case to heatsink			0.3		K/W	
$P_{tot}$	total power dissipation		$T_C = 25^{\circ}C$		115	W	
$I_{FSM}$	max. forward surge current	t = 10 ms; (50 Hz), sine	$T_{VJ} = 45^{\circ}C$		300	A	
		t = 8,3 ms; (60 Hz), sine	$V_R = 0\text{ V}$		325	A	
		t = 10 ms; (50 Hz), sine	$T_{VJ} = 150^{\circ}C$		255	A	
		t = 8,3 ms; (60 Hz), sine	$V_R = 0\text{ V}$		275	A	
$I^2t$	value for fusing	t = 10 ms; (50 Hz), sine	$T_{VJ} = 45^{\circ}C$		450	A <sup>2</sup> s	
		t = 8,3 ms; (60 Hz), sine	$V_R = 0\text{ V}$		440	A <sup>2</sup> s	
		t = 10 ms; (50 Hz), sine	$T_{VJ} = 150^{\circ}C$		325	A <sup>2</sup> s	
		t = 8,3 ms; (60 Hz), sine	$V_R = 0\text{ V}$		315	A <sup>2</sup> s	
$C_J$	junction capacitance	$V_R = 400\text{ V}; f = 1\text{ MHz}$	$T_{VJ} = 25^{\circ}C$		10	pF	



Package ISO247		Ratings				
Symbol	Definition	Conditions	min.	typ.	max.	Unit
$I_{RMS}$	RMS current	per terminal			50	A
$T_{VJ}$	virtual junction temperature		-55		175	°C
$T_{op}$	operation temperature		-55		150	°C
$T_{stg}$	storage temperature		-55		150	°C
<b>Weight</b>				6		g
$M_D$	mounting torque		0.8		1.2	Nm
$F_C$	mounting force with clip		20		120	N
$d_{Spp/ App}$	creepage distance on surface   striking distance through air	terminal to terminal	2.7			mm
$d_{Spb/ Apb}$		terminal to backside	4.1			mm
$V_{ISOL}$	isolation voltage	t = 1 second	3600			V
		t = 1 minute	3000			V

**Product Marking**



**Part description**

- D = Diode
- M = Standard Rectifier
- A = (up to 1800V)
- 30 = Current Rating [A]
- P = Phase leg
- 1600 = Reverse Voltage [V]
- HR = ISO247 (3)

Ordering	Ordering Number	Marking on Product	Delivery Mode	Quantity	Code No.
Standard	DMA30P1600HR	DMA30P1600HR	Tube	30	512442

**Equivalent Circuits for Simulation**

\* on die level

$T_{VJ} = 175^{\circ}C$

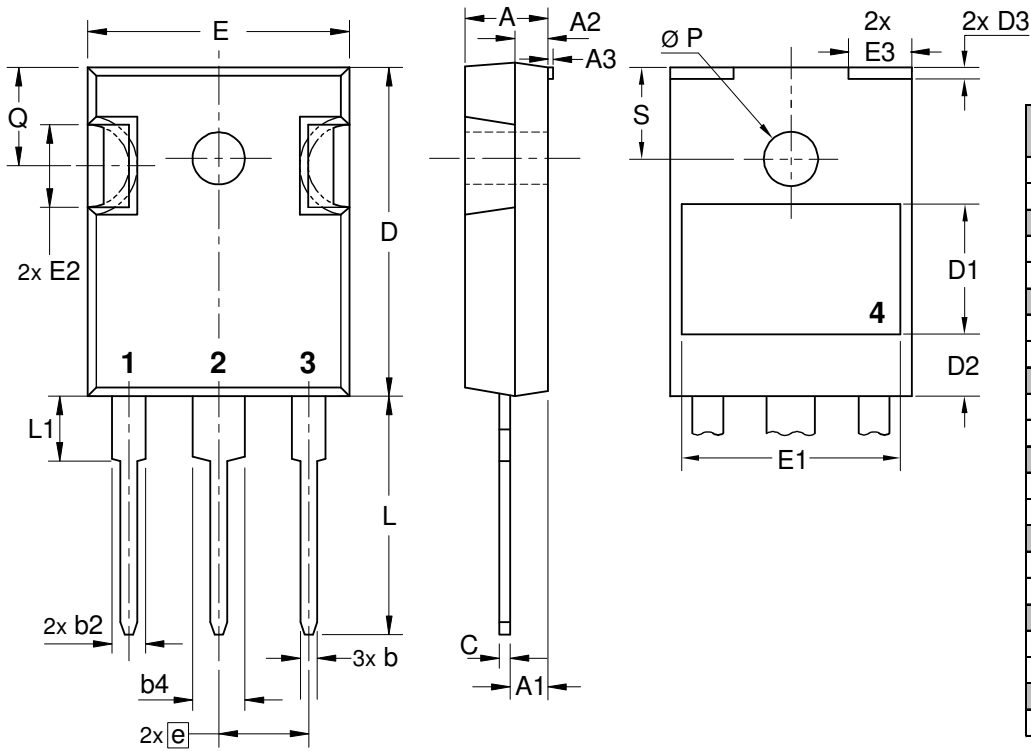


**Rectifier**

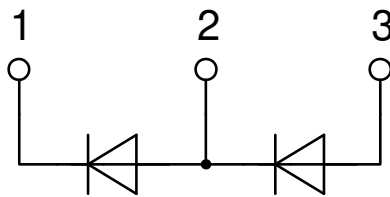
$V_{0\ max}$	threshold voltage	0.82	V
$R_{0\ max}$	slope resistance *	10.9	mΩ



Outlines ISO247



Dim.	Millimeter		Inches	
	min	max	min	max
A	4.70	5.30	0.185	0.209
A1	2.21	2.59	0.087	0.102
A2	1.50	2.49	0.059	0.098
A3	typ. 0.05		typ. 0.002	
b	0.99	1.40	0.039	0.055
b2	1.65	2.39	0.065	0.094
b4	2.59	3.43	0.102	0.135
c	0.38	0.89	0.015	0.035
D	20.79	21.45	0.819	0.844
D1	typ. 8.90		typ. 0.350	
D2	typ. 2.90		typ. 0.114	
D3	typ. 1.00		typ. 0.039	
E	15.49	16.24	0.610	0.639
E1	typ. 13.45		typ. 0.530	
E2	4.31	5.48	0.170	0.216
E3	typ. 4.00		typ. 0.157	
e	5.46 BSC		0.215 BSC	
L	19.80	20.30	0.780	0.799
L1	-	4.49	-	0.177
Ø P	3.55	3.65	0.140	0.144
Q	5.38	6.19	0.212	0.244
S	6.14 BSC		0.242 BSC	



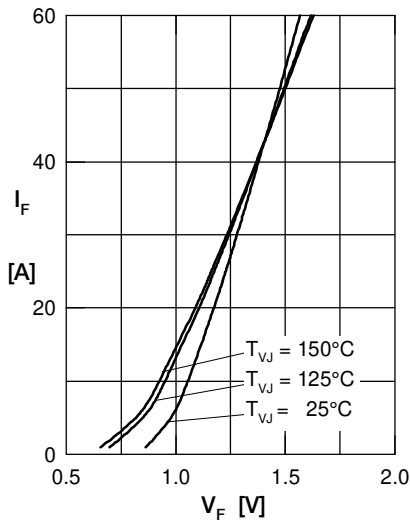
**Rectifier**


Fig. 1 Forward current versus voltage drop per diode

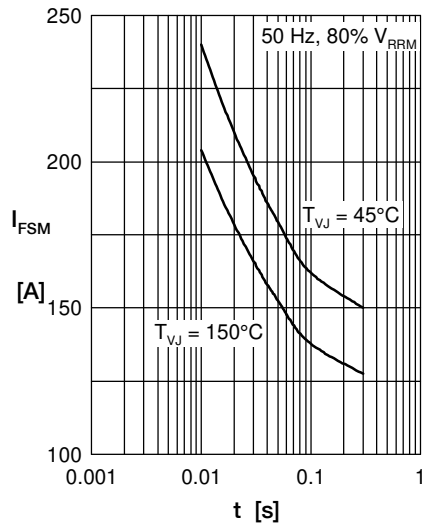


Fig. 2 Surge overload current vs. time per diode

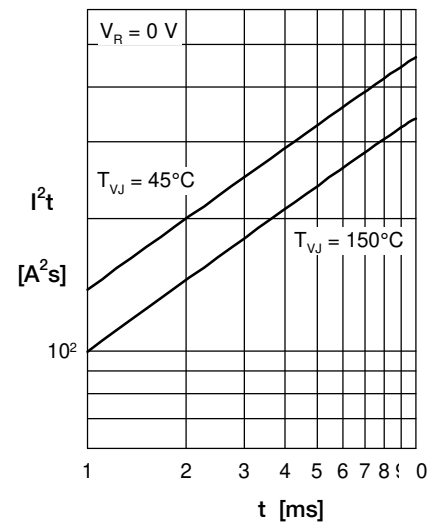
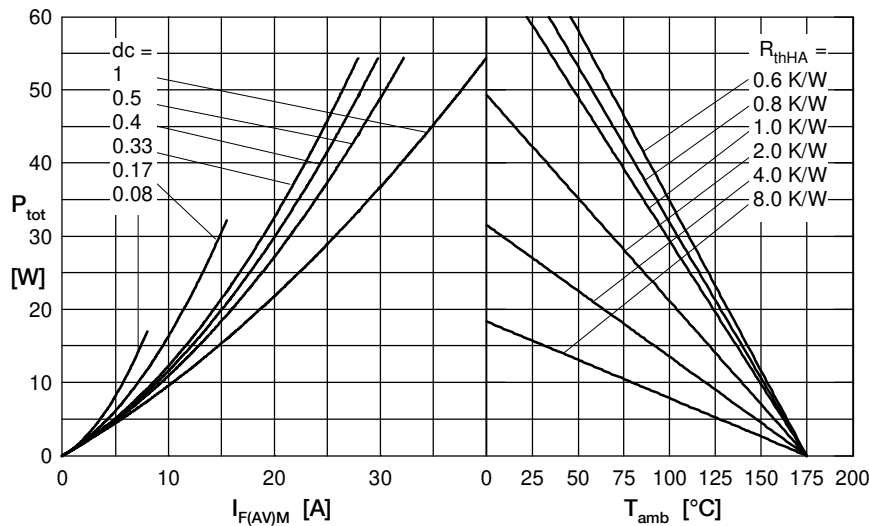

 Fig. 3  $I^2t$  versus time per diode


Fig. 4 Power dissipation vs. direct output current and ambient temperature per diode

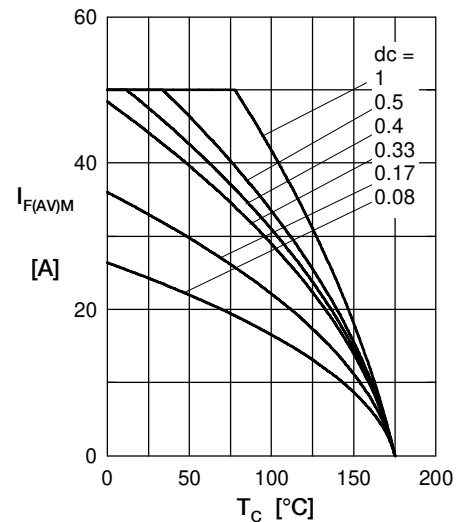


Fig. 5 Max. forward current vs. case temperature per diode

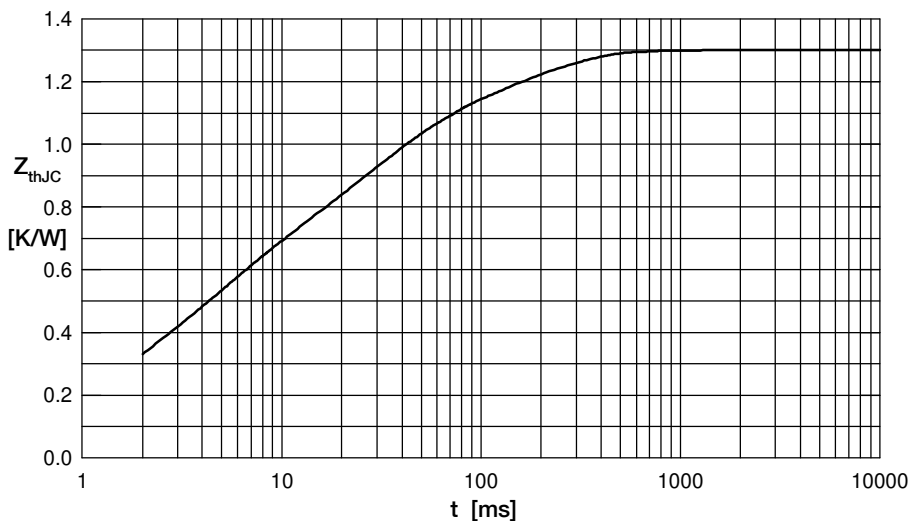


Fig. 6 Transient thermal impedance junction to case vs. time per diode

 Constants for  $Z_{thJC}$  calculation:

i	$R_{thi}$ (K/W)	$t_i$ (s)
1	0.060	0.0004
2	0.170	0.0020
3	0.310	0.0040
4	0.470	0.0240
5	0.290	0.1500

## X-ON Electronics

Largest Supplier of Electrical and Electronic Components

*Click to view similar products for [Rectifiers](#) category:*

*Click to view products by [IXYS](#) manufacturer:*

Other Similar products are found below :

[D91A](#) [DA24F4100L](#) [DD89N1600K-A](#) [DD89N16K-K](#) [RL252-TP](#) [DLA11C-TR-E](#) [DSA17G](#) [1N4005-TR](#) [BAV199-TP](#) [UFS120Je3/TR13](#)  
[JANS1N6640US](#) [VS-80-1293](#) [DD89N16K](#) [DD89N16K-A](#) [481235F](#) [DSP10G-TR-E](#) [RRE02VS6SGTR](#) [067907F](#) [MS306](#) [ND104N08K](#)  
[SPA2003-B-D-A01](#) [VS-80-6193](#) [VS-66-9903](#) [VGF0136AB](#) [US2JFL-TP](#) [UFS105Je3/TR13](#) [A1N5404G-G](#) [ACGRA4007-HF](#) [ACGRB207-HF](#)  
[RF301B2STL](#) [RF501B2STL](#) [UES1306](#) [UES1302](#) [BAV199E6433HTMA1](#) [ACGRC307-HF](#) [ACEFC304-HF](#) [JANTXV1N5660A](#) [UES1106](#)  
[GS2K-LTP](#) [D126A45C](#) [D251N08B](#) [SCHJ22.5K](#) [SM100](#) [SCPA2](#) [SCH10000](#) [SDHD5K](#) [STTH20P035FP](#) [VS-8EWS12S-M3](#) [VS-](#)  
[12FL100S10](#) [ACGRA4001-HF](#)