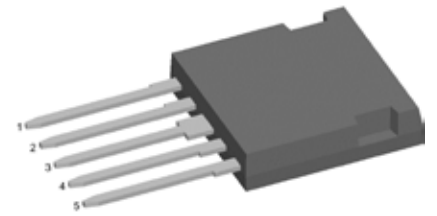
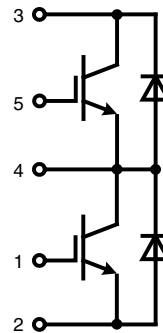

IGBT phaseleg

in ISOPLUS i4-PAC™

 $I_{C25} = 30 \text{ A}$
 $V_{CES} = 600 \text{ V}$
 $V_{CE(sat) \text{ typ.}} = 1.9 \text{ V}$

E72873

IGBT					
Symbol	Conditions	Maximum Ratings			
V_{CES}	$T_{VJ} = 25^\circ\text{C to } 150^\circ\text{C}$	600	V		
V_{GES}		± 20	V		
I_{C25}	$T_C = 25^\circ\text{C}$	30	A		
I_{C90}	$T_C = 90^\circ\text{C}$	18	A		
I_{CM}	$V_{GE} = \pm 15 \text{ V}; R_G = 47 \Omega; T_{VJ} = 125^\circ\text{C}$	40	A		
V_{CEK}	RBSOA Clamped inductive load; $L = 100 \mu\text{H}$	V_{CES}			
t_{SC} (SCSOA)	$V_{CE} = V_{CES}; V_{GE} = \pm 15 \text{ V}; R_G = 47 \Omega$ $T_{VJ} = 125^\circ\text{C}; \text{non-repetitive}$	10	μs		
P_{tot}	$T_C = 25^\circ\text{C}$	100	W		
Symbol	Conditions	Characteristic Values			
($T_{VJ} = 25^\circ\text{C}$, unless otherwise specified)					
		min.	typ.	max.	
$V_{CE(sat)}$	$I_C = 20 \text{ A}; V_{GE} = 15 \text{ V}$		1.9	2.4	V
			2.2		V
$V_{GE(th)}$	$I_C = 0.5 \text{ mA}; V_{GE} = V_{CE}$	4.5		6.5	V
I_{CES}	$V_{CE} = V_{CES}; V_{GE} = 0 \text{ V}$		0.6	0.6	mA
					mA
I_{GES}	$V_{CE} = 0 \text{ V}; V_{GE} = \pm 20 \text{ V}$			200	nA
$t_{d(on)}$	Inductive load $V_{CE} = 300 \text{ V}; I_C = 20 \text{ A}$ $V_{GE} = \pm 15 \text{ V}; R_G = 47 \Omega$ $T_{VJ} = 125^\circ\text{C}$		50		ns
t_r			55		ns
$t_{d(off)}$			200		ns
t_f			30		ns
E_{on}			0.75		mJ
E_{off}			0.6		mJ
C_{ies}	$V_{CE} = 25 \text{ V}; V_{GE} = 0 \text{ V}; f = 1 \text{ MHz}$		1.1		nF
Q_{Gon}	$V_{CE} = 300 \text{ V}; V_{GE} = 15 \text{ V}; I_C = 20 \text{ A}$		65		nC
R_{thJC}				1.25	K/W
R_{thJH}	with heatsink compound		2.5		K/W

Features

- NPT IGBT technology
- low saturation voltage
- positive temperature coefficient for easy paralleling
- fast switching
- HiPerFRED™ diode
- optimized fast and soft reverse recovery
- low operating forward voltage
- low leakage current
- ISOPLUS i4-PAC™ package
- isolated back surface
- low coupling capacity between pins and heatsink
- enlarged creepage towards heatsink
- application friendly pinout
- low inductive current path
- high reliability
- industry standard outline
- UL registered E 72873

Applications

- single phaseleg
 - buck-boost chopper
- H bridge
 - power supplies
 - induction heating
 - four quadrant DC drives
 - controlled rectifier
- three phase bridge
 - AC drives
 - controlled rectifier

Diode						
Symbol	Conditions		Maximum Ratings			
V_{RRM}	$T_{VJ} = 25^{\circ}\text{C}$ to 150°C		600	V		
I_{F25}	$T_C = 25^{\circ}\text{C}$		30	A		
I_{F90}	$T_C = 90^{\circ}\text{C}$		15	A		
Symbol	Conditions		Characteristic Values			
			min.	typ.	max.	
V_F	$I_F = 20\text{ A}$	$T_{VJ} = 25^{\circ}\text{C}$		2.3	2.7	V
		$T_{VJ} = 125^{\circ}\text{C}$		1.6		V
I_{RM} t_{rr}	} $I_F = 15\text{ A}; di_F/dt = -400\text{ A}/\mu\text{s};$ $V_R = 300\text{ V}; V_{GE} = 0\text{ V};$	$T_{VJ} = 125^{\circ}\text{C}$		7		A
				50		ns
R_{thJC}	(per diode)				2.3	K/W
R_{thJH}	with heatsink compound			4.6		K/W

Component						
Symbol	Conditions		Maximum Ratings			
T_{VJ}	operating		-55...+150	$^{\circ}\text{C}$		
T_{stg}			-55...+125	$^{\circ}\text{C}$		
V_{ISOL}	$I_{ISOL} \leq 1\text{ mA}; 50/60\text{ Hz}; t = 1\text{ s}$		2500	V~		
F_C	Mounting force with clip		20...120	Nm		
Symbol	Conditions		Characteristic Values			
			min.	typ.	max.	
C_P	coupling capacity between shorted pins and mounting tab in the case			40		pF
d_S, d_A	pin - pin		1.7			mm
d_S, d_A	pin - backside metal		5.5			mm
Weight				6		g

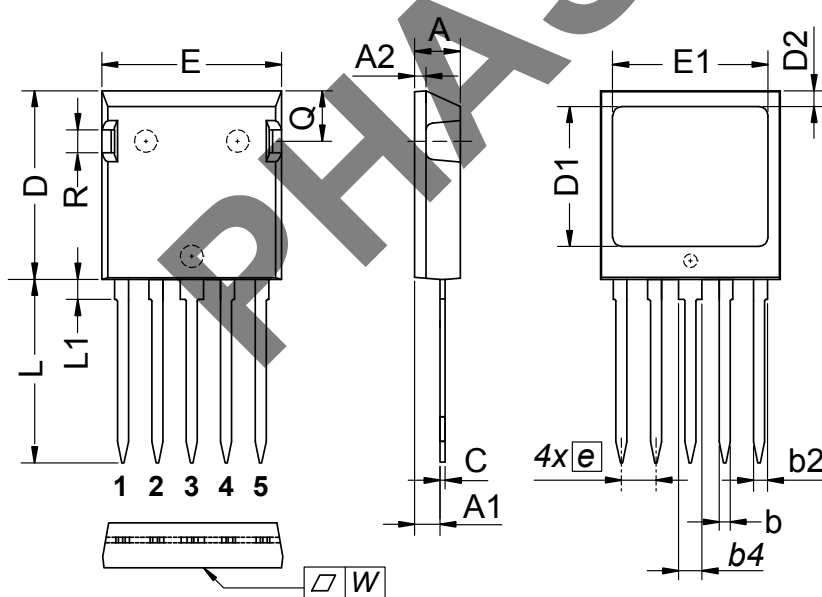

DIM.	MILLIMETER		INCHES	
	MIN	MAX	MIN	MAX
A	4.83	5.21	0.190	0.205
A1	2.59	3.00	0.102	0.118
A2	1.17	2.16	0.046	0.085
b	1.14	1.40	0.045	0.055
b2	1.47	1.73	0.058	0.068
b4	2.54	2.79	0.100	0.110
C	0.51	0.74	0.020	0.029
D	20.80	21.34	0.819	0.840
D1	14.99	15.75	0.590	0.620
D2	1.65	2.03	0.065	0.080
E	19.56	20.29	0.770	0.799
E1	16.76	17.53	0.660	0.690
e	3.81 BSC		0.15 BSC	
L	19.81	21.34	0.780	0.840
L1	2.11	2.59	0.083	0.102
Q	5.33	6.20	0.210	0.244
R	2.54	4.57	0.100	0.180
W	—	0.10	—	0.004

Die konvexe Form des Substrates ist typ. < 0.05 mm über der Kunststoffoberfläche der Bauteilunterseite
 The convex bow of substrate is typ. < 0.05 mm over plastic surface level of device bottom side

Typ. output characteristics

$$I_C = f(V_{CE})$$

parameter: $t_p = 250 \mu s$; $T_j = 25^\circ C$

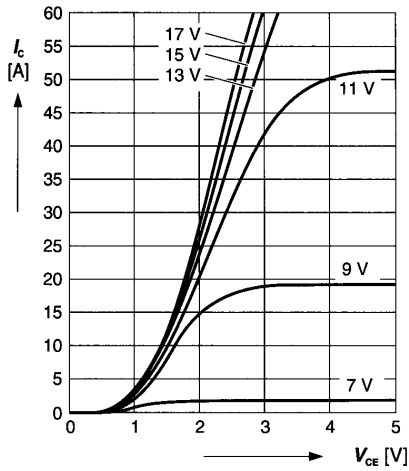

Typ. output characteristics

$$I_C = f(V_{CE})$$

parameter: $t_p = 250 \mu s$; $T_j = 125^\circ C$

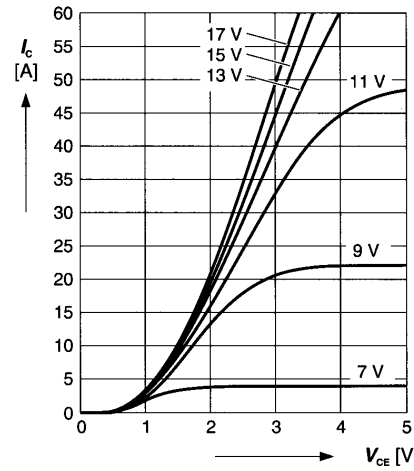

Typ. gate charge

$$V_{GE} = f(Q_g)$$

parameter: $I_{C\ pulis} = 20\ A$

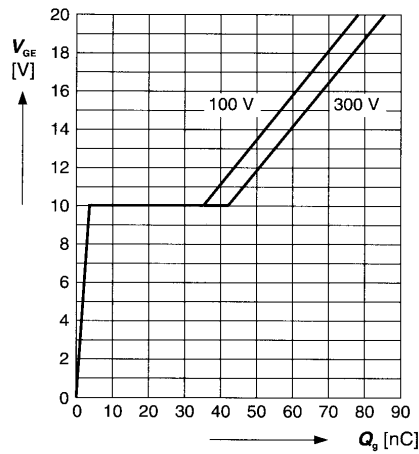

Typ. capacitances

$$C = f(V_{CE})$$

parameter: $V_{GE} = 0\ V$; $f = 1\ MHz$

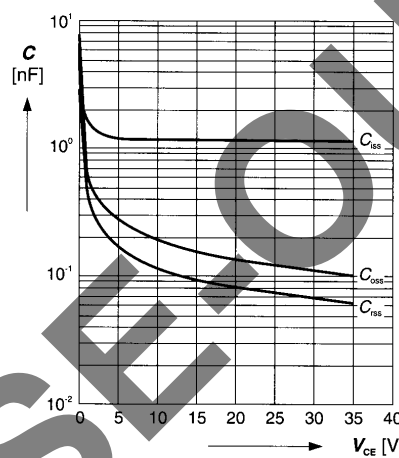

Reverse biased safe operating area

$$I_{C\ pulis} = f(V_{CE}), T_j = 150^\circ C$$

parameter: $V_{GE} = 15\ V$

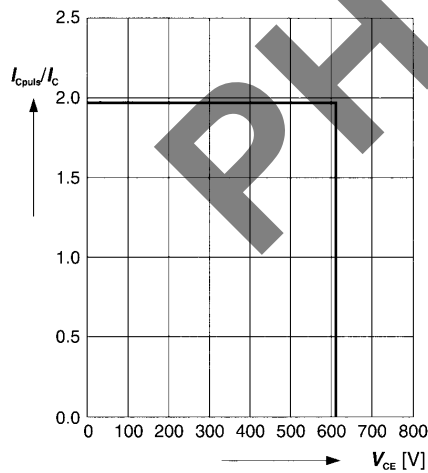

Short circuit safe operating area

$$I_{C\ sc} = f(V_{CE}), T_j = 150^\circ C$$

parameter: $V_{GE} = \pm 15\ V$; $t_{sc} \le 10\ \mu s$; $L < 50\ nH$

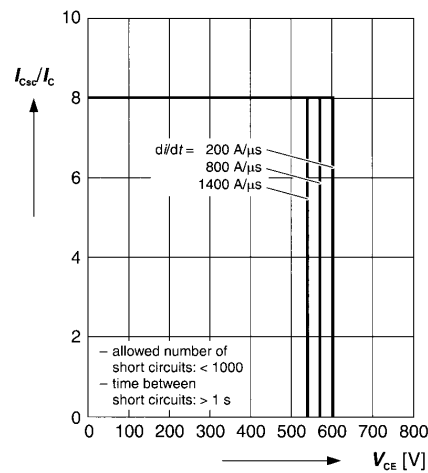

Typ. switching time

$t = f(I_C)$, inductive load, $T_J = 125\text{ }^\circ\text{C}$
 parameter: $V_{CE} = 300\text{ V}$; $V_{GE} = \pm 15\text{ V}$; $R_G = 33\text{ }\Omega$

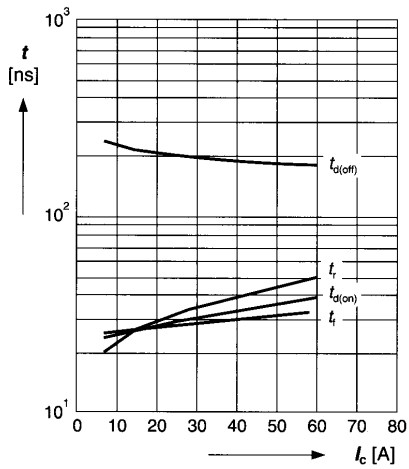

Typ. switching time

$t = f(R_G)$, inductive load, $T_J = 125\text{ }^\circ\text{C}$
 parameter: $V_{CE} = 300\text{ V}$; $V_{GE} = \pm 15\text{ V}$; $I_C = 30\text{ A}$

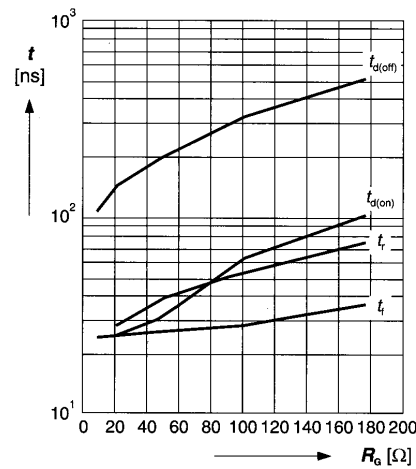

Typ. switching losses

$E = f(I_C)$, inductive load, $T_J = 125\text{ }^\circ\text{C}$
 parameter: $V_{CE} = 300\text{ V}$; $V_{GE} = \pm 15\text{ V}$; $R_G = 33\text{ }\Omega$

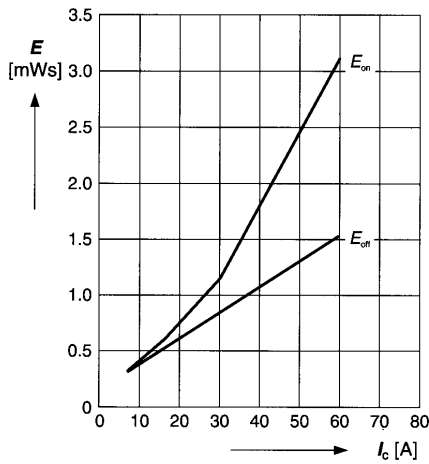

Typ. switching losses

$E = f(R_G)$, inductive load, $T_J = 125\text{ }^\circ\text{C}$
 parameter: $V_{CE} = 300\text{ V}$; $V_{GE} = \pm 15\text{ V}$; $I_C = 30\text{ A}$

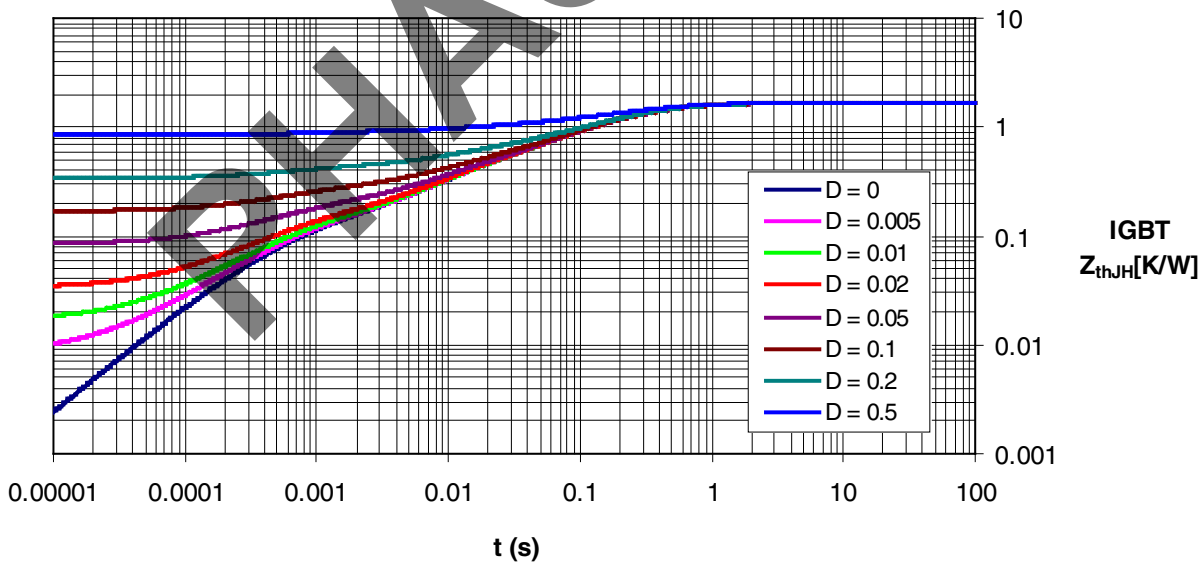
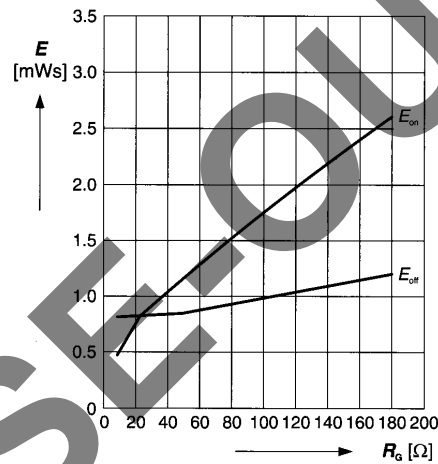

Diode

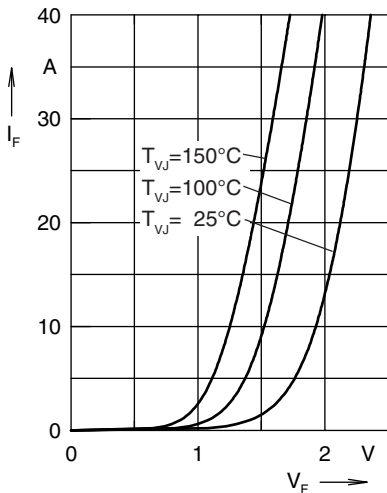

Forward current I_F versus V_F

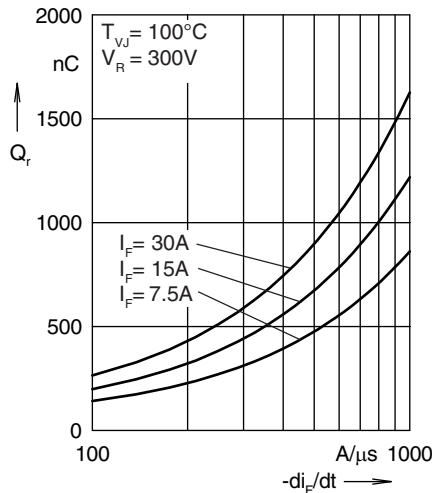

Reverse recovery charge Q_r versus $-di_F/dt$

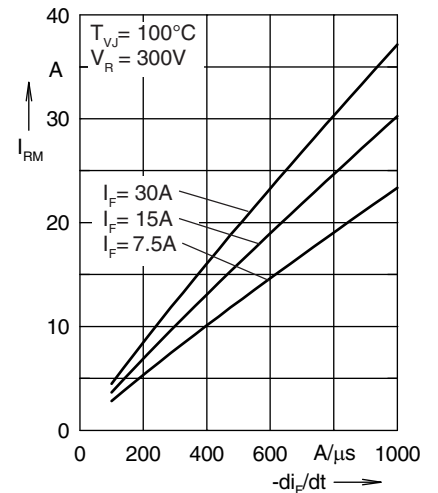

Peak reverse current I_{RM} versus $-di_F/dt$

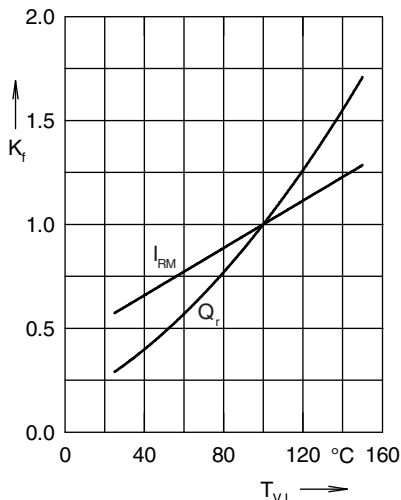

Dynamic parameters Q_r , I_{RM} versus T_{VJ}

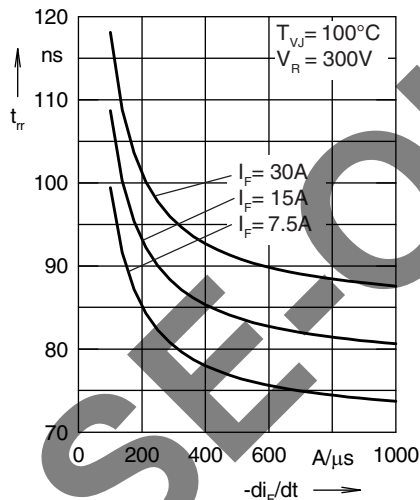

Recovery time t_{tr} versus $-di_F/dt$

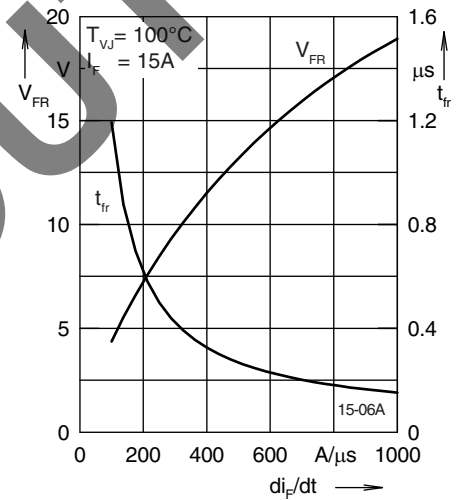

Peak forward voltage V_{FR} and t_{tr} versus di_F/dt

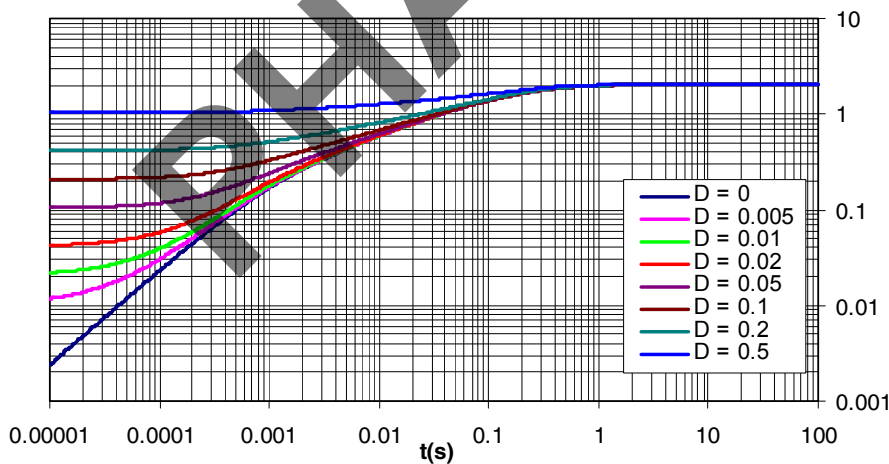

Transient thermal resistance junction to heatsink

FRED
 Z_{thjH} [K/W]

X-ON Electronics

Largest Supplier of Electrical and Electronic Components

Click to view similar products for [IGBT Transistors](#) category:

Click to view products by [IXYS](#) manufacturer:

Other Similar products are found below :

[748152A](#) [APT20GT60BRDQ1G](#) [APT50GT60BRG](#) [NGTB10N60FG](#) [STGFW20V60DF](#) [APT30GP60BG](#) [APT45GR65B2DU30](#)
[GT50JR22\(STA1ES\)](#) [TIG058E8-TL-H](#) [IGW40N120H3FKSA1](#) [VS-CPV364M4KPBF](#) [NGTB25N120FL2WAG](#) [NGTG40N120FL2WG](#)
[RJH60F3DPQ-A0#T0](#) [APT40GR120B2SCD10](#) [APT15GT120BRG](#) [APT20GT60BRG](#) [NGTB75N65FL2WAG](#) [NGTG15N120FL2WG](#)
[IXA30RG1200DHGLB](#) [IXA40RG1200DHGLB](#) [APT70GR65B2DU40](#) [NTE3320](#) [QP12W05S-37A](#) [IHF40N65R5SFKSA1](#) [APT70GR120J](#)
[APT35GP120JDQ2](#) [IKZA40N65RH5XKSA1](#) [IKFW75N65ES5XKSA1](#) [IKFW50N65ES5XKSA1](#) [IKFW50N65EH5XKSA1](#)
[IKFW40N65ES5XKSA1](#) [IKFW60N65ES5XKSA1](#) [IMBG120R090M1HXTMA1](#) [IMBG120R220M1HXTMA1](#) [XD15H120CX1](#)
[XD25H120CX0](#) [XP15PJS120CL1B1](#) [IGW30N60H3FKSA1](#) [STGWA8M120DF3](#) [IGW08T120FKSA1](#) [IGW75N60H3FKSA1](#)
[HGTG40N60B3](#) [FGH60N60SMD_F085](#) [FGH75T65UPD](#) [STGWA15H120F2](#) [IKA10N60TXKSA1](#) [IHW20N120R5XKSA1](#) [RJH60D2DPP-](#)
[M0#T2](#) [IKP20N60TXKSA1](#)