

PolarHV™ Power MOSFET

N-Channel Enhancement Mode
Fast Recovery Diode
Avalanche Rated

IXFH 16N80P
IXFT 16N80P
IXFV 16N80P
IXFV 16N80PS

$V_{DSS} = 800 \text{ V}$
 $I_{D25} = 16 \text{ A}$
 $R_{DS(on)} \leq 600 \text{ m}\Omega$
 $t_{rr} \leq 250 \text{ ns}$

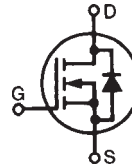

| Symbol | Test Conditions | Maximum Ratings | |
|------------|---|-----------------|------------------|
| | | | |
| V_{DSS} | $T_J = 25^\circ\text{C}$ to 150°C | 800 | V |
| V_{DGR} | $T_J = 25^\circ\text{C}$ to 150°C ; $R_{GS} = 1 \text{ M}\Omega$ | 800 | V |
| V_{GSS} | Continuous | ± 30 | V |
| V_{GSM} | Transient | ± 40 | V |
| I_{D25} | $T_C = 25^\circ\text{C}$ | 16 | A |
| I_{DM} | $T_C = 25^\circ\text{C}$, pulse width limited by T_{JM} | 40 | A |
| I_{AR} | $T_C = 25^\circ\text{C}$ | 8 | A |
| E_{AR} | $T_C = 25^\circ\text{C}$ | 30 | mJ |
| E_{AS} | $T_C = 25^\circ\text{C}$ | 1.0 | J |
| dv/dt | $I_S \leq I_{DM}$, $di/dt \leq 100 \text{ A}/\mu\text{s}$, $V_{DD} \leq V_{DSS}$ $T_J \leq 150^\circ\text{C}$, $R_G = 5 \Omega$ | 10 | V/ns |
| P_D | $T_C = 25^\circ\text{C}$ | 460 | W |
| T_J | | -55 ... +150 | $^\circ\text{C}$ |
| T_{JM} | | 150 | $^\circ\text{C}$ |
| T_{stg} | | -55 ... +150 | $^\circ\text{C}$ |
| T_L | 1.6 mm (0.062 in.) from case for 10 s | 300 | $^\circ\text{C}$ |
| T_{SOLD} | Plastic body for 10 s | 260 | $^\circ\text{C}$ |
| M_d | Mounting torque (TO-247) | 1.13/10 | Nm/lb.in. |
| F_c | Mounting force (PLUS220) | 11..65/2.5..15 | N/lb |
| Weight | TO-247 | 6.0 | g |
| | TO-268 | 5.0 | g |
| | PLUS220 & PLUS220SMD | 4.0 | g |

TO-247 (IXFH)

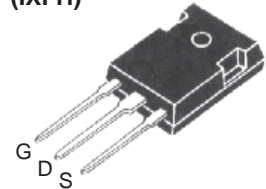

TO-268 (IXFT)

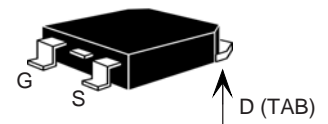

PLUS220 (IXFV)

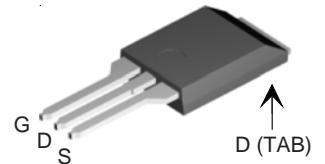

PLUS220SMD (IXFV...S)

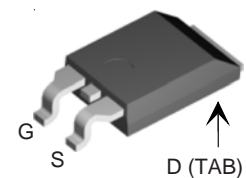

G = Gate D = Drain
S = Source TAB = Drain

| Symbol | Test Conditions ($T_J = 25^\circ\text{C}$, unless otherwise specified) | Characteristic Values | | |
|--------------|---|-----------------------|------|----------------------|
| | | Min. | Typ. | Max. |
| BV_{DSS} | $V_{GS} = 0 \text{ V}$, $I_D = 250 \mu\text{A}$ | 800 | | V |
| $V_{GS(th)}$ | $V_{DS} = V_{GS}$, $I_D = 4 \text{ mA}$ | 3.0 | | V |
| I_{GSS} | $V_{GS} = \pm 30 \text{ V}$, $V_{DS} = 0 \text{ V}$ | | | $\pm 100 \text{ nA}$ |
| I_{DSS} | $V_{DS} = V_{DSS}$ $V_{GS} = 0 \text{ V}$ $T_J = 125^\circ\text{C}$ | | | 25 μA |
| | | | | 250 μA |
| $R_{DS(on)}$ | $V_{GS} = 10 \text{ V}$, $I_D = 0.5 I_{D25}$ Pulse test, $t \leq 300 \mu\text{s}$, duty cycle $d \leq 2\%$ | | | 600 $\text{m}\Omega$ |

Features

- Fast Recovery diode
- Unclamped Inductive Switching (UIS) rated
- International standard packages
- Low package inductance
- easy to drive and to protect

Advantages

- Easy to mount
- Space savings
- High power density

| Symbol | Test Conditions | Characteristic Values ($T_J = 25^\circ\text{C}$, unless otherwise specified) | | |
|--------------|---|---|------|-------------------------|
| | | Min. | Typ. | Max. |
| g_{fs} | $V_{DS} = 20\text{ V}; I_D = 0.5 I_{D25}$, pulse test | 9 | 16 | S |
| C_{iss} | $V_{GS} = 0\text{ V}, V_{DS} = 25\text{ V}, f = 1\text{ MHz}$ | | 4600 | pF |
| C_{oss} | | | 330 | pF |
| C_{rss} | | | 23 | pF |
| $t_{d(on)}$ | $V_{GS} = 10\text{ V}, V_{DS} = V_{DSS}, I_D = 0.5 I_{D25}$ $R_G = 5\ \Omega$ (External) | | 27 | ns |
| t_r | | | 32 | ns |
| $t_{d(off)}$ | | | 75 | ns |
| t_f | | | 29 | ns |
| $Q_{g(on)}$ | $V_{GS} = 10\text{ V}, V_{DS} = 0.5 V_{DSS}, I_D = 0.5 I_{D25}$ | | 71 | nC |
| Q_{gs} | | | 21 | nC |
| Q_{gd} | | | 23 | nC |
| R_{thJC} | (TO-247) | | | 0.27 $^\circ\text{C/W}$ |
| R_{thCS} | | | 0.21 | $^\circ\text{C/W}$ |

| Symbol | Test Conditions | Characteristic Values ($T_J = 25^\circ\text{C}$, unless otherwise specified) | | |
|----------|---|---|------|---------------|
| | | Min. | Typ. | Max. |
| I_s | $V_{GS} = 0\text{ V}$ | | | 16 A |
| I_{SM} | Repetitive | | | 48 A |
| V_{SD} | $I_F = I_s, V_{GS} = 0\text{ V}$, pulse test | | | 1.5 V |
| t_{rr} | $I_F = 25\text{ A}, -di/dt = 100\text{ A}/\mu\text{s}$ $V_R = 100\text{ V}; V_{GS} = 0\text{ V}$ | | 150 | 250 ns |
| I_{RM} | | | 7 | A |
| Q_{RM} | | | 0.7 | μC |

IXYS reserves the right to change limits, test conditions, and dimensions.

IXYS MOSFETs and IGBTs are covered by 4,835,592 4,931,844 5,049,961 5,237,481 6,162,665 6,404,065 B1 6,683,344 6,727,585 7,005,734 B2
 one or more of the following U.S. patents: 4,850,072 5,017,508 5,063,307 5,381,025 6,259,123 B1 6,534,343 6,710,405 B2 6,759,692 7,063,975 B2
 4,881,106 5,034,796 5,187,117 5,486,715 6,306,728 B1 6,583,505 6,710,463 6,771,478 B2 7,071,537

Fig. 1. Output Characteristics @ 25°C

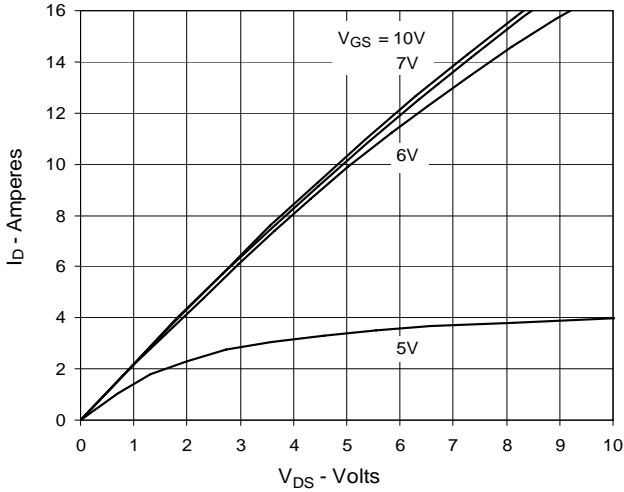

Fig. 2. Extended Output Characteristics @ 25°C

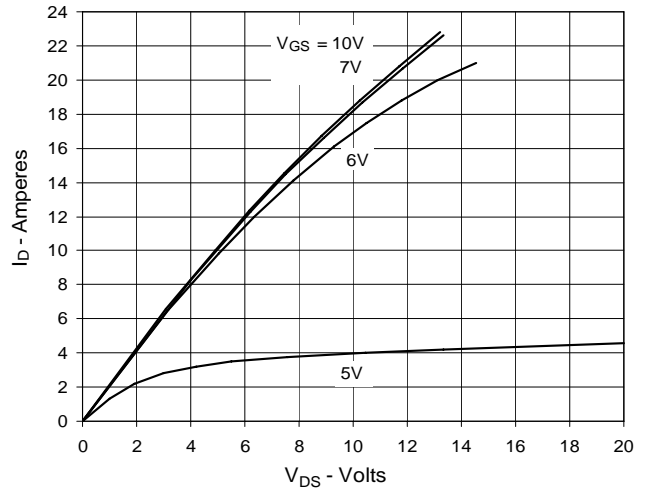

Fig. 3. Output Characteristics @ 125°C

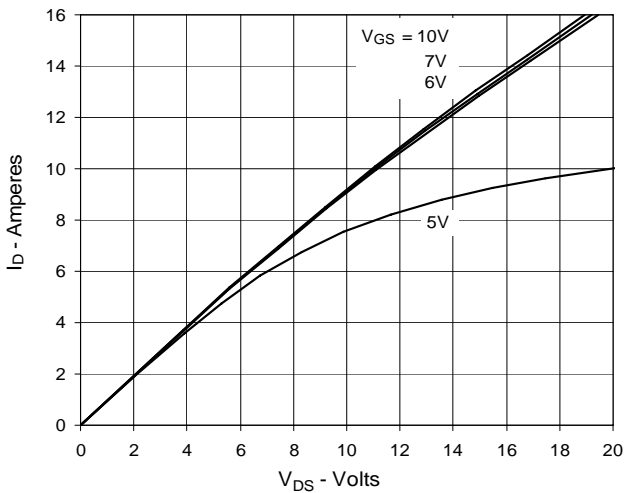

Fig. 4. $R_{DS(on)}$ Normalized to $I_D = 8A$ Value vs. Junction Temperature

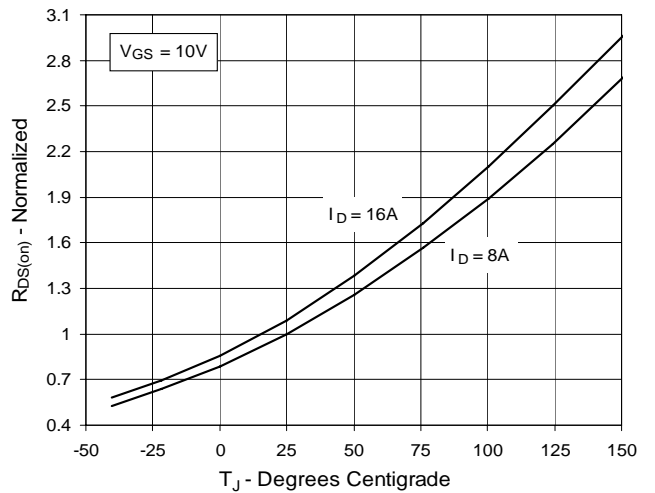

Fig. 5. $R_{DS(on)}$ Normalized to $I_D = 8A$ Value vs. Drain Current

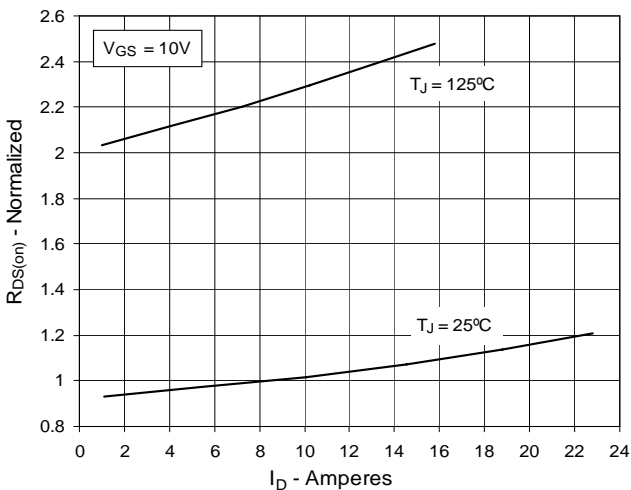

Fig. 6. Maximum Drain Current vs. Case Temperature

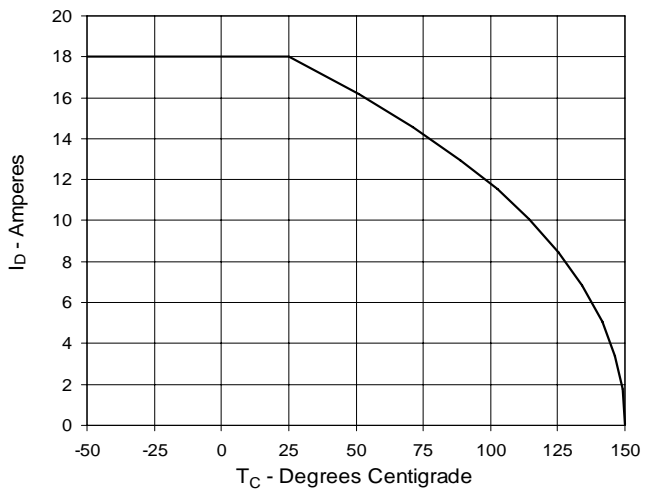

Fig. 7. Input Admittance

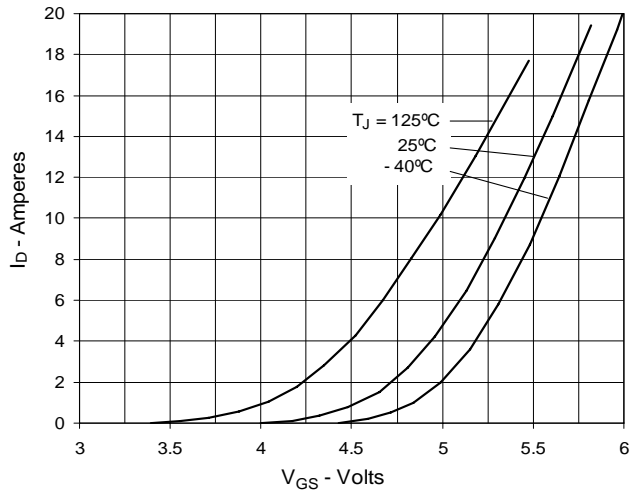

Fig. 8. Transconductance

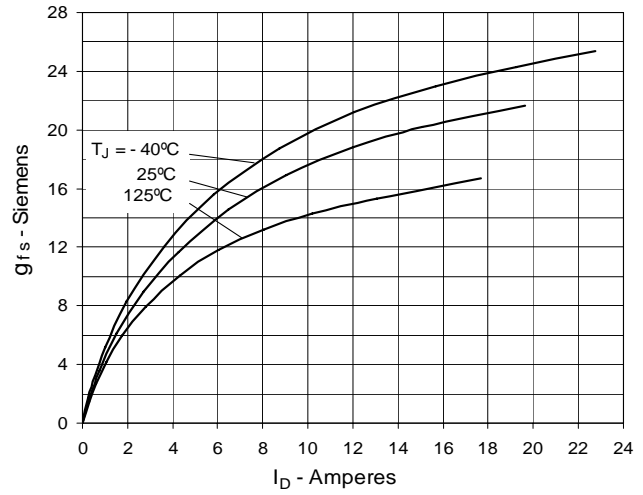

Fig. 9. Forward Voltage Drop of Intrinsic Diode

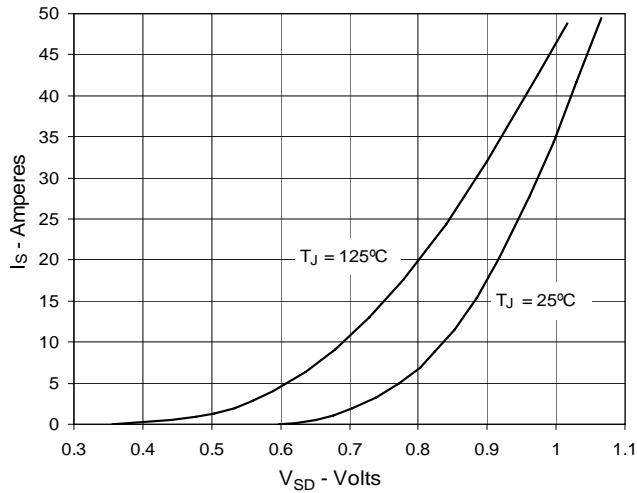

Fig. 10. Gate Charge

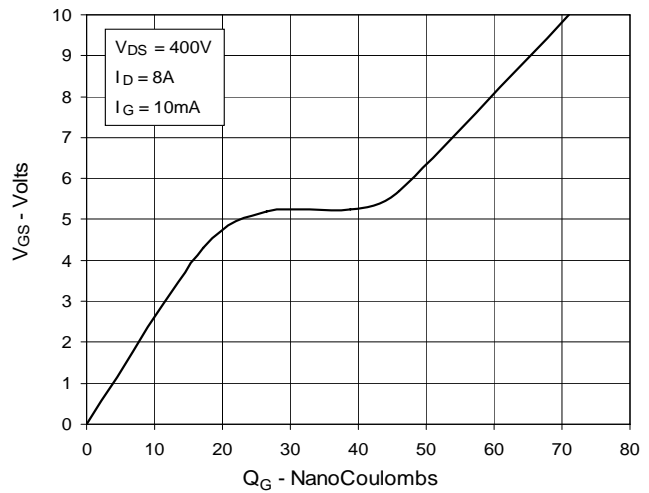

Fig. 11. Capacitance

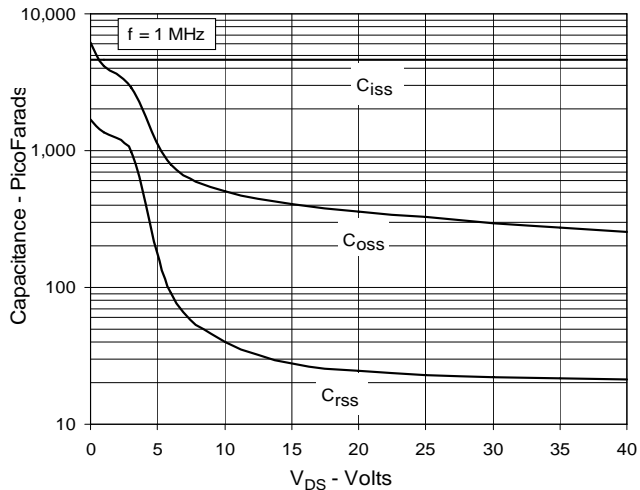
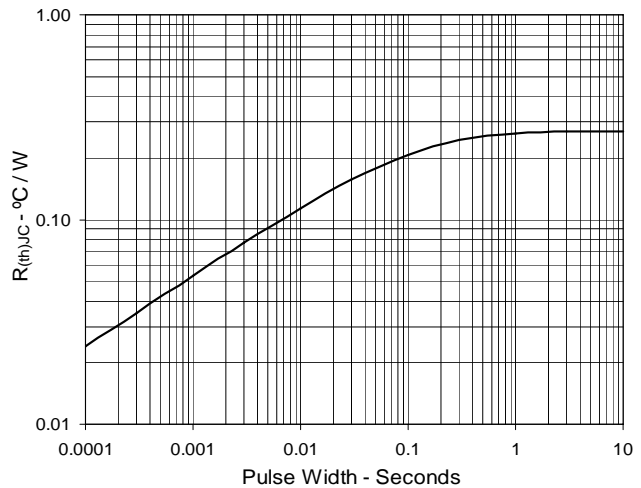
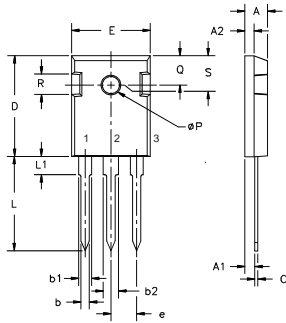

Fig. 12. Maximum Transient Thermal Resistance



TO-247 AD (IXFH) Outline



| Dim. | Millimeter | | Inches | |
|----------------|------------|-------|---------|-------|
| | Min. | Max. | Min. | Max. |
| A | 4.7 | 5.3 | .185 | .209 |
| A ₁ | 2.2 | 2.54 | .087 | .102 |
| A ₂ | 2.2 | 2.6 | .059 | .098 |
| b | 1.0 | 1.4 | .040 | .055 |
| b ₁ | 1.65 | 2.13 | .065 | .084 |
| b ₂ | 2.87 | 3.12 | .113 | .123 |
| C | .4 | .8 | .016 | .031 |
| D | 20.80 | 21.46 | .819 | .845 |
| E | 15.75 | 16.26 | .610 | .640 |
| e | 5.20 | 5.72 | 0.205 | 0.225 |
| L | 19.81 | 20.32 | .780 | .800 |
| L1 | | 4.50 | | .177 |
| ØP | 3.55 | 3.65 | .140 | .144 |
| Q | 5.89 | 6.40 | 0.232 | 0.252 |
| R | 4.32 | 5.49 | .170 | .216 |
| S | 6.15 BSC | | 242 BSC | |

TO-268 (IXFT) Outline

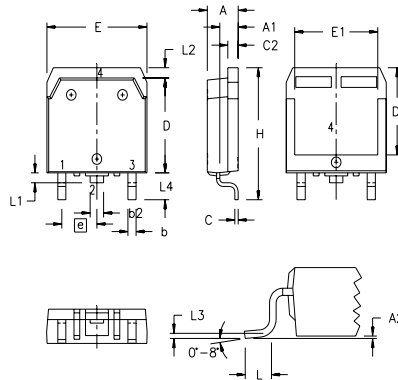

| SYM | INCHES | | MILLIMETERS | |
|----------------|----------|------|-------------|-------|
| | MIN | MAX | MIN | MAX |
| A | .193 | .201 | 4.90 | 5.10 |
| A ₁ | .106 | .114 | 2.70 | 2.90 |
| A ₂ | .001 | .010 | 0.02 | 0.25 |
| b | .045 | .057 | 1.15 | 1.45 |
| b ₂ | .075 | .083 | 1.90 | 2.10 |
| C | .016 | .026 | 0.40 | 0.65 |
| C ₂ | .057 | .063 | 1.45 | 1.60 |
| D | .543 | .551 | 13.80 | 14.00 |
| D ₁ | .488 | .500 | 12.40 | 12.70 |
| E | .624 | .632 | 15.85 | 16.05 |
| E ₁ | .524 | .535 | 13.30 | 13.60 |
| e | .215 BSC | | 5.45 BSC | |
| H | .736 | .752 | 18.70 | 19.10 |
| L | .094 | .106 | 2.40 | 2.70 |
| L ₁ | .047 | .055 | 1.20 | 1.40 |
| L ₂ | .039 | .045 | 1.00 | 1.15 |
| L ₃ | .010 BSC | | 0.25 BSC | |
| L ₄ | .150 | .161 | 3.80 | 4.10 |

PLUS220 (IXFV) Outline



| SYM | INCHES | | MILLIMETER | |
|----------------|----------|------|------------|-------|
| | MIN | MAX | MIN | MAX |
| A | .169 | .185 | 4.30 | 4.70 |
| A ₁ | .028 | .035 | 0.70 | 0.90 |
| A ₂ | .098 | .118 | 2.50 | 3.00 |
| b | .035 | .047 | 0.90 | 1.20 |
| b ₁ | .080 | .095 | 2.03 | 2.41 |
| b ₂ | .054 | .064 | 1.37 | 1.63 |
| c | .028 | .035 | 0.70 | 0.90 |
| D | .551 | .591 | 14.00 | 15.00 |
| D ₁ | .512 | .539 | 13.00 | 13.70 |
| E | .394 | .433 | 10.00 | 11.00 |
| E ₁ | .331 | .346 | 8.40 | 8.80 |
| e | .100 BSC | | 2.54 BSC | |
| L | .512 | .551 | 13.00 | 14.00 |
| L ₁ | .118 | .138 | 3.00 | 3.50 |
| L ₂ | .035 | .051 | 0.90 | 1.30 |
| L ₃ | .047 | .059 | 1.20 | 1.50 |

1. GATE
2. DRAIN (COLLECTOR)
3. SOURCE (EMITTER)
4. DRAIN (COLLECTOR)

PLUS220SMD (IXFV_S) Outline

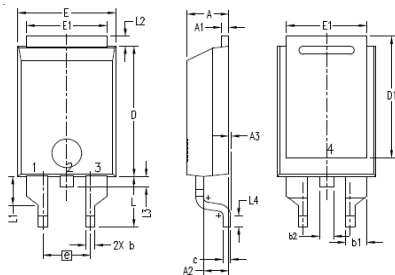

| SYM | INCHES | | MILLIMETER | |
|----------------|----------|------|------------|-------|
| | MIN | MAX | MIN | MAX |
| A | .169 | .185 | 4.30 | 4.70 |
| A ₁ | .028 | .035 | 0.70 | 0.90 |
| A ₂ | .098 | .118 | 2.50 | 3.00 |
| A ₃ | .000 | .010 | 0.00 | 0.25 |
| b | .035 | .047 | 0.90 | 1.20 |
| b ₁ | .080 | .095 | 2.03 | 2.41 |
| b ₂ | .054 | .064 | 1.37 | 1.63 |
| c | .028 | .035 | 0.70 | 0.90 |
| D | .551 | .591 | 14.00 | 15.00 |
| D ₁ | .512 | .539 | 13.00 | 13.70 |
| E | .394 | .433 | 10.00 | 11.00 |
| E ₁ | .331 | .346 | 8.40 | 8.80 |
| e | .200 BSC | | 5.08 BSC | |
| L | .209 | .228 | 5.30 | 5.80 |
| L ₁ | .118 | .138 | 3.00 | 3.50 |
| L ₂ | .035 | .051 | 0.90 | 1.30 |
| L ₃ | .047 | .059 | 1.20 | 1.50 |
| L ₄ | .039 | .059 | 1.00 | 1.50 |

1. GATE
2. DRAIN (COLLECTOR)
3. SOURCE (EMITTER)
4. DRAIN (COLLECTOR)



Disclaimer Notice - Information furnished is believed to be accurate and reliable. However, users should independently evaluate the suitability of and test each product selected for their own applications. Littelfuse products are not designed for, and may not be used in, all applications. Read complete Disclaimer Notice at www.littelfuse.com/disclaimer-electronics.

X-ON Electronics

Largest Supplier of Electrical and Electronic Components

Click to view similar products for [MOSFET](#) category:

Click to view products by [IXYS](#) manufacturer:

Other Similar products are found below :

[614233C](#) [648584F](#) [IRFD120](#) [JANTX2N5237](#) [FCA20N60_F109](#) [FDZ595PZ](#) [2SK2545\(Q,T\)](#) [405094E](#) [423220D](#) [TPCC8103,L1Q\(CM](#)
[MIC4420CM-TR](#) [VN1206L](#) [SBVS138LT1G](#) [614234A](#) [715780A](#) [NTNS3166NZT5G](#) [SSM6J414TU,LF\(T](#) [751625C](#) [BUK954R8-60E](#)
[NTE6400](#) [SQJ402EP-T1-GE3](#) [2SK2614\(TE16L1,Q\)](#) [2N7002KW-FAI](#) [DMN1017UCP3-7](#) [EFC2J004NUZTDG](#) [ECH8691-TL-W](#)
[FCAB21350L1](#) [P85W28HP2F-7071](#) [DMN1053UCP4-7](#) [NTE221](#) [NTE222](#) [NTE2384](#) [NTE2903](#) [NTE2941](#) [NTE2945](#) [NTE2946](#) [NTE2960](#)
[NTE2967](#) [NTE2969](#) [NTE2976](#) [NTE455](#) [NTE6400A](#) [NTE2910](#) [NTE2916](#) [NTE2956](#) [NTE2911](#) [DMN2080UCB4-7](#) [TK10A80W,S4X\(S](#)
[SSM6P69NU,LF](#) [DMP22D4UFO-7B](#)