

**X-Class HiPerFET™
Power MOSFET**
**IXFA24N60X
IXFP24N60X
IXFQ24N60X
IXFH24N60X**
 $V_{DSS} = 600V$
 $I_{D25} = 24A$
 $R_{DS(on)} \leq 175m\Omega$

 N-Channel Enhancement Mode
 Avalanche Rated
 Fast Intrinsic Diode

TO-263 AA (IXFA)

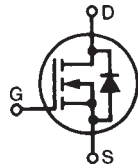
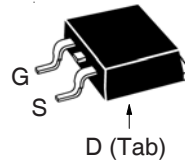

TO-220AB (IXFP)

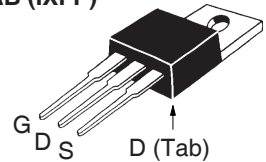

TO-3P (IXFQ)

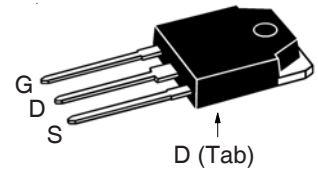

TO-247 (IXFH)

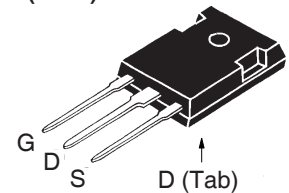
 G = Gate D = Drain
 S = Source Tab = Drain

| Symbol | Test Conditions | Maximum Ratings | |
|---------------|--|--------------------|------------|
| V_{DSS} | $T_J = 25^\circ C$ to $150^\circ C$ | 600 | V |
| V_{DGR} | $T_J = 25^\circ C$ to $150^\circ C$, $R_{GS} = 1M\Omega$ | 600 | V |
| V_{GSS} | Continuous | ± 30 | V |
| V_{GSM} | Transient | ± 40 | V |
| I_{D25} | $T_C = 25^\circ C$ | 24 | A |
| I_{DM} | $T_C = 25^\circ C$, Pulse Width Limited by T_{JM} | 48 | A |
| I_A | $T_C = 25^\circ C$ | 8 | A |
| E_{AS} | $T_C = 25^\circ C$ | 500 | mJ |
| dv/dt | $I_S \leq I_{DM}$, $V_{DD} \leq V_{DSS}$, $T_J \leq 150^\circ C$ | 50 | V/ns |
| P_D | $T_C = 25^\circ C$ | 400 | W |
| T_J | | -55 ... +150 | $^\circ C$ |
| T_{JM} | | 150 | $^\circ C$ |
| T_{stg} | | -55 ... +150 | $^\circ C$ |
| T_L | Maximum Lead Temperature for Soldering | 300 | $^\circ C$ |
| T_{SOLD} | 1.6 mm (0.062in.) from Case for 10s | 260 | $^\circ C$ |
| F_C | Mounting Force (TO-263) | 10..65 / 2.2..14.6 | N/lb |
| M_d | Mounting Torque (TO-220, TO-3P & TO-247) | 1.13 / 10 | Nm/lb.in |
| Weight | TO-263 | 2.5 | g |
| | TO-220 | 3.0 | g |
| | TO-3P | 5.5 | g |
| | TO-247 | 6.0 | g |

| Symbol | Test Conditions ($T_J = 25^\circ C$, Unless Otherwise Specified) | Characteristic Values | | |
|--------------|---|-----------------------|------|----------------|
| | | Min. | Typ. | Max. |
| BV_{DSS} | $V_{GS} = 0V$, $I_D = 250\mu A$ | 600 | | V |
| $V_{GS(th)}$ | $V_{DS} = V_{GS}$, $I_D = 2.5mA$ | 2.5 | | V |
| I_{GSS} | $V_{GS} = \pm 30V$, $V_{DS} = 0V$ | | | ± 100 nA |
| I_{DSS} | $V_{DS} = V_{DSS}$, $V_{GS} = 0V$ $T_J = 125^\circ C$ | | | 20 μA |
| | | | | 750 μA |
| $R_{DS(on)}$ | $V_{GS} = 10V$, $I_D = 0.5 \cdot I_{D25}$, Note 1 | | | 175 m Ω |

Features

- International Standard Packages
- Low $R_{DS(ON)}$ and Q_G
- Avalanche Rated
- Low Package Inductance

Advantages

- High Power Density
- Easy to Mount
- Space Savings

Applications

- Switch-Mode and Resonant-Mode Power Supplies
- DC-DC Converters
- PFC Circuits
- AC and DC Motor Drives
- Robotics and Servo Controls

| Symbol | Test Conditions ($T_J = 25^\circ\text{C}$, Unless Otherwise Specified) | Characteristic Values | | |
|-------------------------------------|--|--|------|-------------------------|
| | | Min. | Typ. | Max |
| g_{fs} | $V_{DS} = 10\text{V}$, $I_D = 0.5 \cdot I_{D25}$, Note 1 | 7 | 12 | S |
| R_{Gi} | Gate Input Resistance | | 2.1 | Ω |
| C_{iss} | } $V_{GS} = 0\text{V}$, $V_{DS} = 25\text{V}$, $f = 1\text{MHz}$ | | 1910 | pF |
| C_{oss} | | | 1400 | pF |
| C_{rss} | | | 18 | pF |
| Effective Output Capacitance | | | | |
| $C_{o(er)}$ | Energy related | } $V_{GS} = 0\text{V}$ $V_{DS} = 0.8 \cdot V_{DSS}$ | 100 | pF |
| $C_{o(tr)}$ | Time related | | 330 | pF |
| Resistive Switching Times | | | | |
| $t_{d(on)}$ | } $V_{GS} = 10\text{V}$, $V_{DS} = 0.5 \cdot V_{DSS}$, $I_D = 0.5 \cdot I_{D25}$ $R_G = 5\Omega$ (External) | | 18 | ns |
| t_r | | | 29 | ns |
| $t_{d(off)}$ | | | 45 | ns |
| t_f | | | 15 | ns |
| $Q_{g(on)}$ | } $V_{GS} = 10\text{V}$, $V_{DS} = 0.5 \cdot V_{DSS}$, $I_D = 0.5 \cdot I_{D25}$ | | 47 | nC |
| Q_{gs} | | | 11 | nC |
| Q_{gd} | | | 23 | nC |
| R_{thJC} | | | | 0.31 $^\circ\text{C/W}$ |
| R_{thCS} | TO-220 | | 0.50 | $^\circ\text{C/W}$ |
| | TO-247 & TO-3P | | 0.25 | $^\circ\text{C/W}$ |

Source-Drain Diode

| Symbol | Test Conditions ($T_J = 25^\circ\text{C}$, Unless Otherwise Specified) | Characteristic Values | | |
|----------|--|-----------------------|------|-------|
| | | Min. | Typ. | Max |
| I_S | $V_{GS} = 0\text{V}$ | | | 24 A |
| I_{SM} | Repetitive, pulse Width Limited by T_{JM} | | | 96 A |
| V_{SD} | $I_F = I_S$, $V_{GS} = 0\text{V}$, Note 1 | | | 1.4 V |
| t_{rr} | } $I_F = 12\text{A}$, $-di/dt = 100\text{A}/\mu\text{s}$ $V_R = 100\text{V}$ | | 140 | ns |
| Q_{RM} | | | 840 | nC |
| I_{RM} | | | 12 | A |

Note 1. Pulse test, $t \leq 300\mu\text{s}$, duty cycle, $d \leq 2\%$.

PRELIMINARY TECHNICAL INFORMATION

The product presented herein is under development. The Technical Specifications offered are derived from a subjective evaluation of the design, based upon prior knowledge and experience, and constitute a "considered reflection" of the anticipated result. IXYS reserves the right to change limits, test conditions, and dimensions without notice.

IXYS Reserves the Right to Change Limits, Test Conditions, and Dimensions.

| | | | | | | | | | | |
|--|-----------|-----------|-----------|-----------|-------------|-------------|-------------|-------------|-------------|-------------|
| IXYS MOSFETs and IGBTs are covered by one or more of the following U.S. patents: | 4,835,592 | 4,931,844 | 5,049,961 | 5,237,481 | 6,162,665 | 6,404,065B1 | 6,683,344 | 6,727,585 | 7,005,734B2 | 7,157,338B2 |
| | 4,860,072 | 5,017,508 | 5,063,307 | 5,381,025 | 6,259,123B1 | 6,534,343 | 6,710,405B2 | 6,759,692 | 7,063,975B2 | |
| | 4,881,106 | 5,034,796 | 5,187,117 | 5,486,715 | 6,306,728B1 | 6,583,505 | 6,710,463 | 6,771,478B2 | 7,071,537 | |

Fig. 1. Output Characteristics @ $T_J = 25^\circ\text{C}$

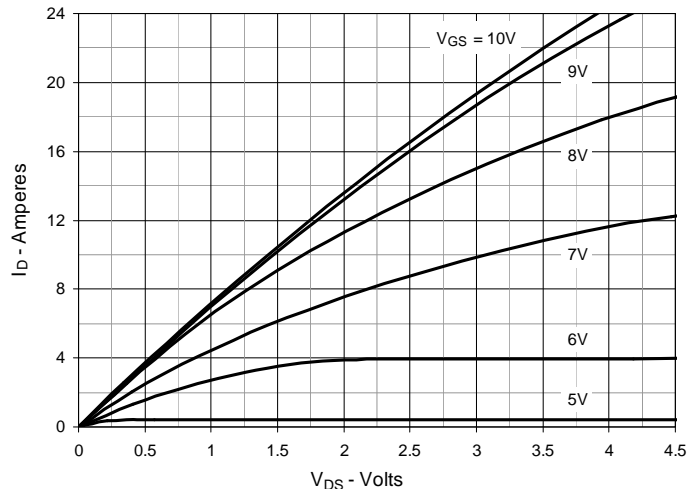

Fig. 2. Extended Output Characteristics @ $T_J = 25^\circ\text{C}$

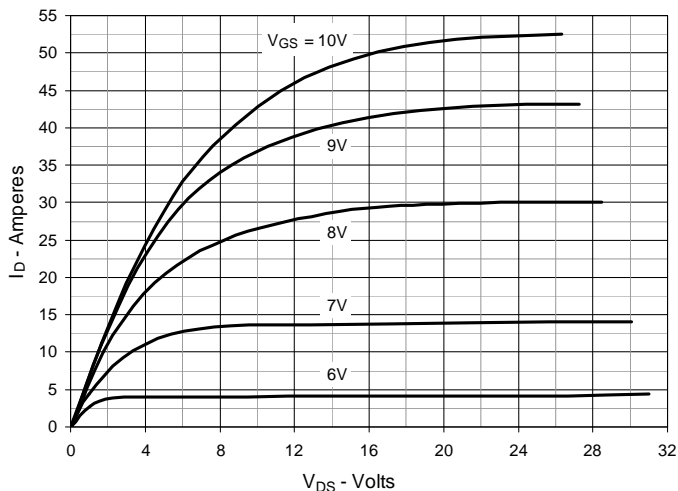

Fig. 3. Output Characteristics @ $T_J = 125^\circ\text{C}$

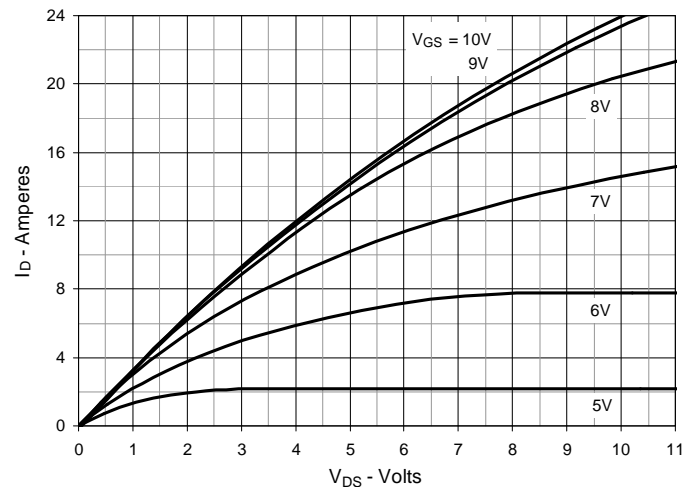

Fig. 4. $R_{DS(on)}$ Normalized to $I_D = 12\text{A}$ Value vs. Junction Temperature

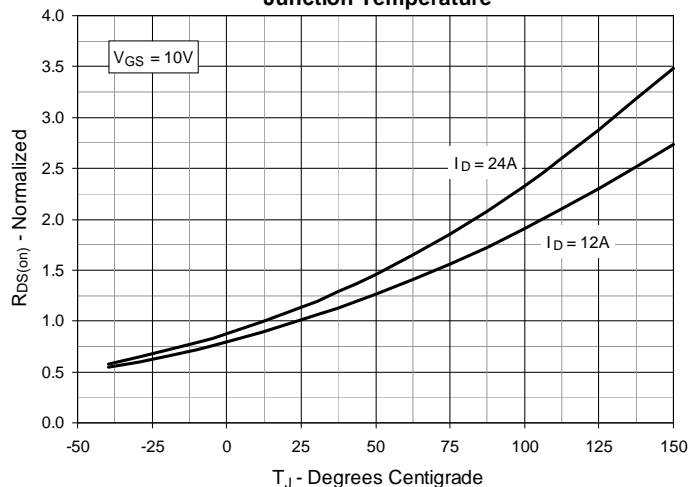

Fig. 5. $R_{DS(on)}$ Normalized to $I_D = 12\text{A}$ Value vs. Drain Current

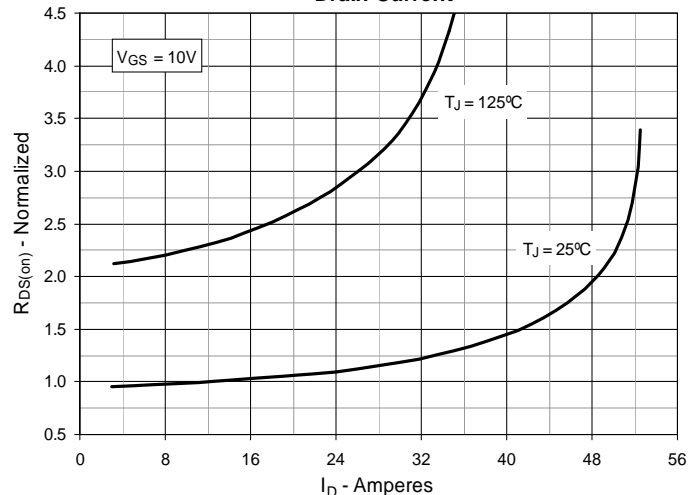

Fig. 6. Maximum Drain Current vs. Case Temperature

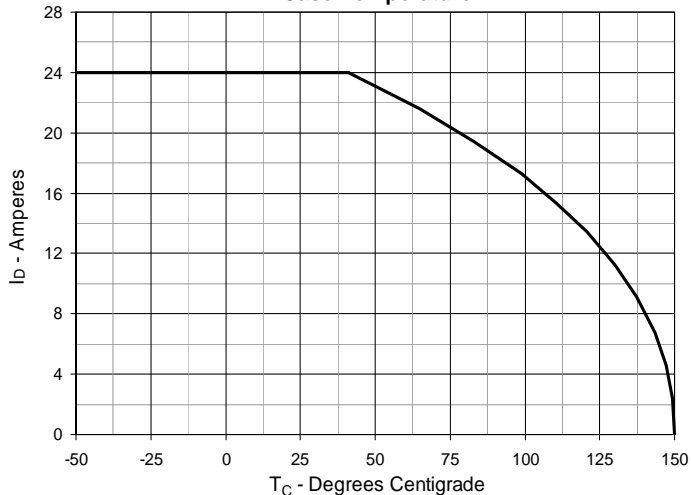

Fig. 7. Input Admittance

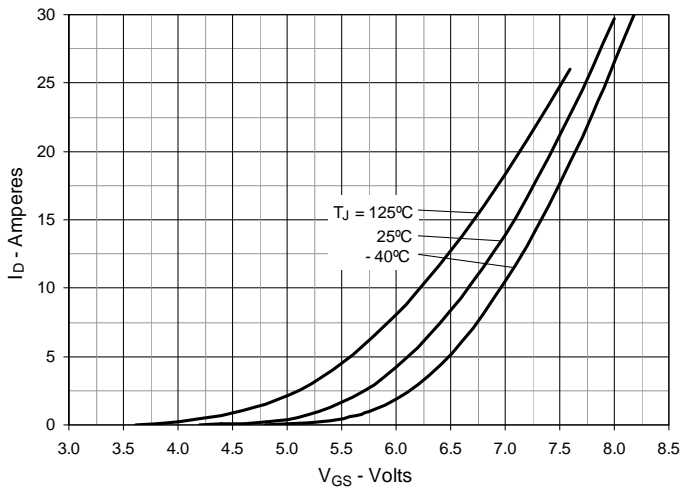

Fig. 8. Transconductance

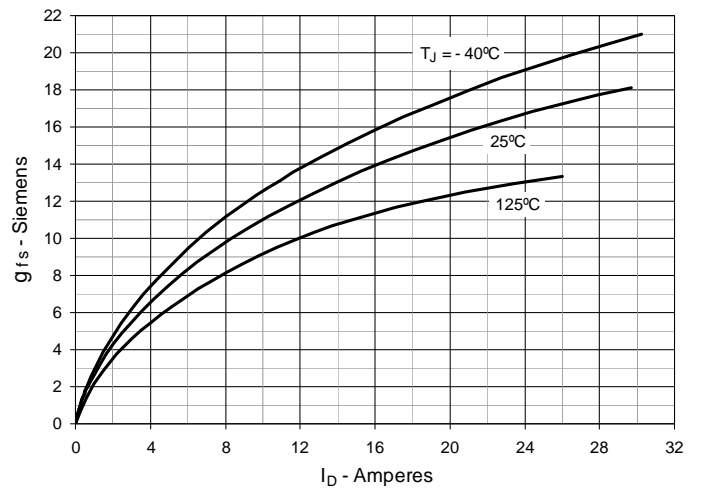

Fig. 9. Forward Voltage Drop of Intrinsic Diode

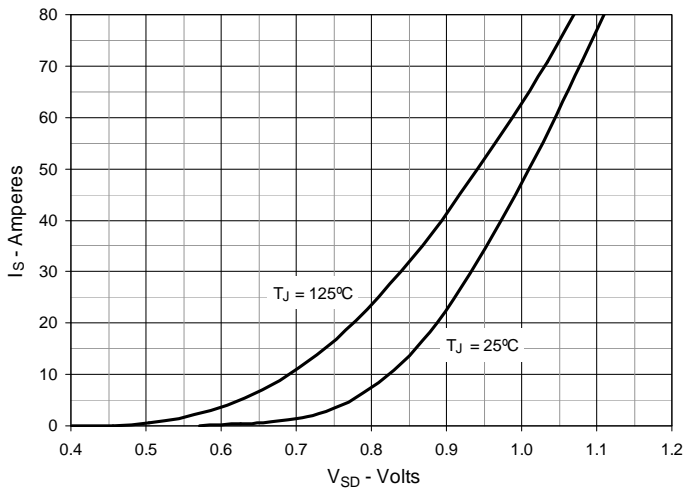

Fig. 10. Gate Charge

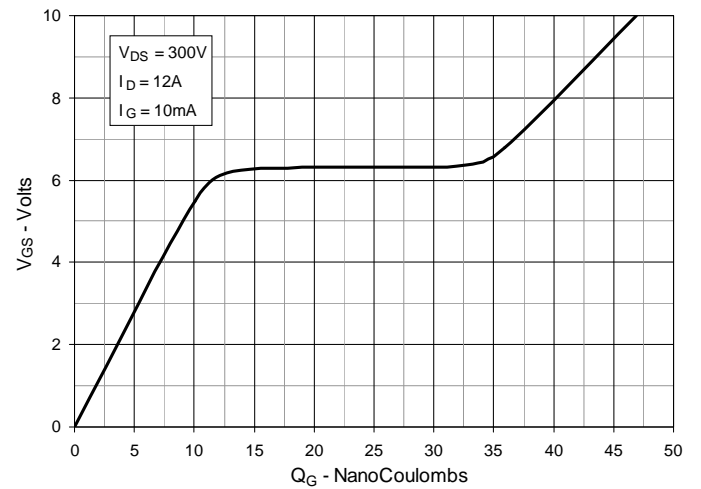

Fig. 11. Capacitance

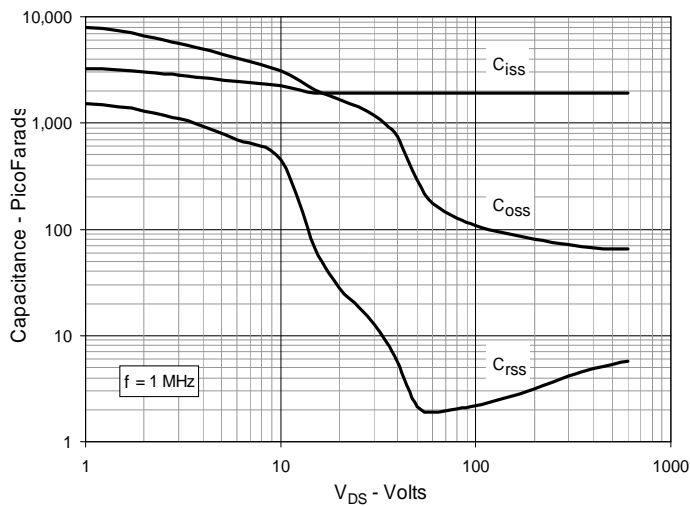

Fig. 12. Forward-Bias Safe Operating Area

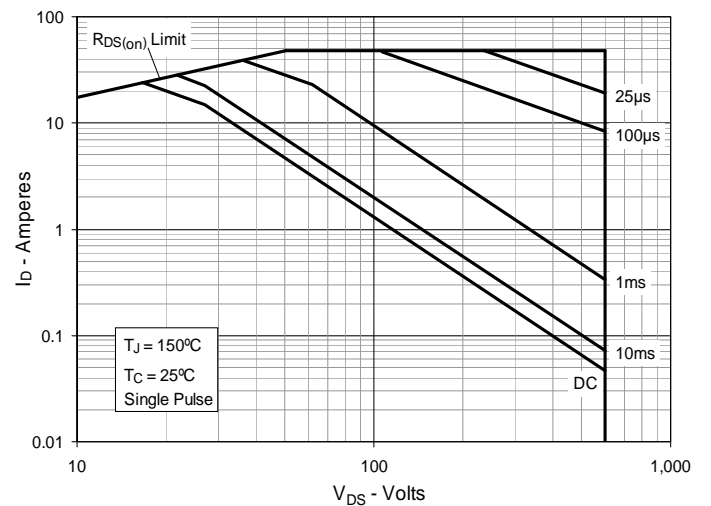

Fig. 13. Output Capacitance Stored Energy

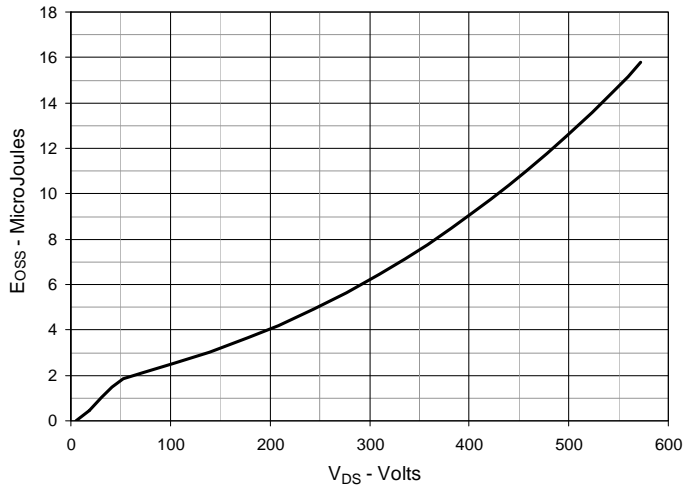
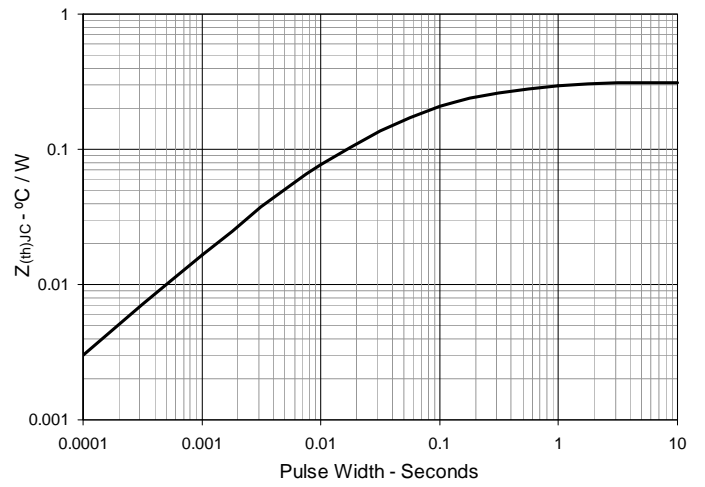
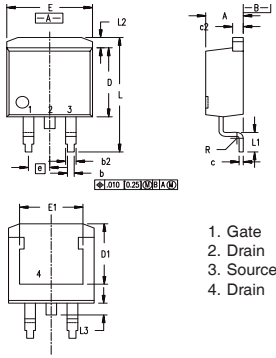

Fig. 14. Maximum Transient Thermal Impedance



TO-263 Outline



- 1. Gate
- 2. Drain
- 3. Source
- 4. Drain

| Dim. | Millimeter | | Inches | |
|------|------------|-------|--------|------|
| | Min. | Max. | Min. | Max. |
| A | 4.06 | 4.83 | .160 | .190 |
| b | 0.51 | 0.99 | .020 | .039 |
| b2 | 1.14 | 1.40 | .045 | .055 |
| c | 0.40 | 0.74 | .016 | .029 |
| c2 | 1.14 | 1.40 | .045 | .055 |
| D | 8.64 | 9.65 | .340 | .380 |
| D1 | 8.00 | 8.89 | .280 | .320 |
| E | 9.65 | 10.41 | .380 | .405 |
| E1 | 6.22 | 8.13 | .270 | .320 |
| e | 2.54 | BSC | .100 | BSC |
| L | 14.61 | 15.88 | .575 | .625 |
| L1 | 2.29 | 2.79 | .090 | .110 |
| L2 | 1.02 | 1.40 | .040 | .055 |
| L3 | 1.27 | 1.78 | .050 | .070 |
| L4 | 0 | 0.13 | 0 | .005 |

TO-3P Outline

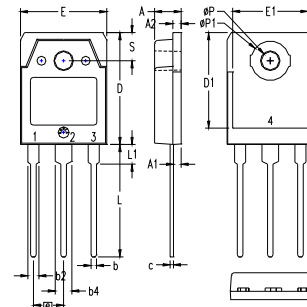

- 1. Gate
- 2. Drain
- 3. Source
- 4. Drain

| SYM | INCHES | | MILLIMETERS | |
|-----|----------|------|-------------|-------|
| | MIN | MAX | MIN | MAX |
| A | .185 | .193 | 4.70 | 4.90 |
| A1 | .051 | .059 | 1.30 | 1.50 |
| A2 | .057 | .065 | 1.45 | 1.65 |
| b | .035 | .045 | 0.90 | 1.15 |
| b2 | .075 | .087 | 1.90 | 2.20 |
| b4 | .114 | .126 | 2.90 | 3.20 |
| c | .022 | .031 | 0.55 | 0.80 |
| D | .780 | .799 | 19.80 | 20.30 |
| D1 | .665 | .677 | 16.90 | 17.20 |
| E | .610 | .622 | 15.50 | 15.80 |
| E1 | .531 | .539 | 13.50 | 13.70 |
| e | .215 BSC | | 5.45 BSC | |
| L | .779 | .795 | 19.80 | 20.20 |
| L1 | .134 | .142 | 3.40 | 3.60 |
| øP | .126 | .134 | 3.20 | 3.40 |
| øP1 | .272 | .280 | 6.90 | 7.10 |
| S | .193 | .201 | 4.90 | 5.10 |

TO-247 Outline

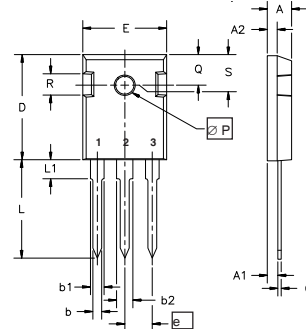

- Terminals: 1 - Gate 2 - Drain
3 - Source

| Dim. | Millimeter | | Inches | |
|----------------|------------|-------|--------|-------|
| | Min. | Max. | Min. | Max. |
| A | 4.7 | 5.3 | .185 | .209 |
| A ₁ | 2.2 | 2.54 | .087 | .102 |
| A ₂ | 2.2 | 2.6 | .059 | .098 |
| b | 1.0 | 1.4 | .040 | .055 |
| b ₁ | 1.65 | 2.13 | .065 | .084 |
| b ₂ | 2.87 | 3.12 | .113 | .123 |
| C | .4 | .8 | .016 | .031 |
| D | 20.80 | 21.46 | .819 | .845 |
| E | 15.75 | 16.26 | .610 | .640 |
| e | 5.20 | 5.72 | 0.205 | 0.225 |
| L | 19.81 | 20.32 | .780 | .800 |
| L1 | | 4.50 | | .177 |
| øP | 3.55 | 3.65 | .140 | .144 |
| Q | 5.89 | 6.40 | 0.232 | 0.252 |
| R | 4.32 | 5.49 | .170 | .216 |
| S | 6.15 | BSC | 242 | BSC |

TO-220 Outline

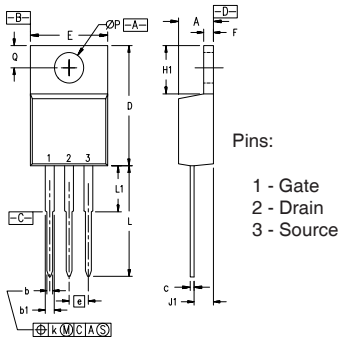

- Pins:
1 - Gate
2 - Drain
3 - Source

| SYM | INCHES | | MILLIMETERS | |
|-----|----------|------|-------------|-------|
| | MIN | MAX | MIN | MAX |
| A | .170 | .190 | 4.32 | 4.83 |
| b | .025 | .040 | 0.64 | 1.02 |
| b1 | .045 | .065 | 1.15 | 1.65 |
| c | .014 | .022 | 0.35 | 0.56 |
| D | .580 | .630 | 14.73 | 16.00 |
| E | .390 | .420 | 9.91 | 10.66 |
| e | .100 BSC | | 2.54 BSC | |
| F | .045 | .055 | 1.14 | 1.40 |
| H1 | .230 | .270 | 5.85 | 6.85 |
| J1 | .090 | .110 | 2.29 | 2.79 |
| k | 0 | .015 | 0 | 0.38 |
| L | .500 | .550 | 12.70 | 13.97 |
| L1 | .110 | .230 | 2.79 | 5.84 |
| øP | .139 | .161 | 3.53 | 4.08 |
| Q | .100 | .125 | 2.54 | 3.18 |

X-ON Electronics

Largest Supplier of Electrical and Electronic Components

Click to view similar products for [MOSFET](#) category:

Click to view products by [IXYS](#) manufacturer:

Other Similar products are found below :

[614233C](#) [648584F](#) [MCH3443-TL-E](#) [MCH6422-TL-E](#) [FDPF9N50NZ](#) [FW216A-TL-2W](#) [FW231A-TL-E](#) [APT5010JVR](#) [NTNS3A92PZT5G](#)
[IRF100S201](#) [JANTX2N5237](#) [2SK2464-TL-E](#) [2SK3818-DL-E](#) [FCA20N60_F109](#) [FDZ595PZ](#) [STD6600NT4G](#) [FSS804-TL-E](#) [2SJ277-DL-E](#)
[2SK1691-DL-E](#) [2SK2545\(Q,T\)](#) [405094E](#) [423220D](#) [MCH6646-TL-E](#) [TPCC8103,L1Q\(CM](#) [367-8430-0972-503](#) [VN1206L](#) [424134F](#)
[026935X](#) [051075F](#) [SBVS138LT1G](#) [614234A](#) [715780A](#) [NTNS3166NZT5G](#) [751625C](#) [873612G](#) [IRF7380TRHR](#) [IPS70R2K0CEAKMA1](#)
[RJK60S3DPP-E0#T2](#) [RJK60S5DPK-M0#T0](#) [APT5010JVFR](#) [APT12031JFLL](#) [APT12040JVR](#) [DMN3404LQ-7](#) [NTE6400](#) [JANTX2N6796U](#)
[JANTX2N6784U](#) [JANTXV2N5416U4](#) [SQM110N05-06L-GE3](#) [SIHF35N60E-GE3](#) [2SK2614\(TE16L1,Q\)](#)