

# TrenchT2™ HiperFET™ Power MOSFET

**IXFA76N15T2**  
**IXFP76N15T2**  
**IXFH76N15T2**

**V<sub>DSS</sub> = 150V**  
**I<sub>D25</sub> = 76A**  
**R<sub>DS(on)</sub> ≤ 22mΩ**

N-Channel Enhancement Mode  
Avalanche Rated  
Fast Intrinsic Rectifier



| Symbol            | Test Conditions  | Maximum Ratings    |          |
|-------------------|--|--------------------|----------|
| V <sub>DSS</sub>  | T <sub>J</sub> = 25°C to 175°C   | 150                | V        |
| V <sub>DGR</sub>  | T <sub>J</sub> = 25°C to 175°C, R <sub>GS</sub> = 1MΩ  | 150                | V        |
| V <sub>GSS</sub>  | Continuous   | ± 20               | V        |
| V <sub>GSM</sub>  | Transient  | ± 30               | V        |
| I <sub>D25</sub>  | T <sub>C</sub> = 25°C  | 76                 | A        |
| I <sub>DM</sub>   | T <sub>C</sub> = 25°C, Pulse Width Limited by T <sub>JM</sub>                                  | 200                | A        |
| I <sub>A</sub>    | T <sub>C</sub> = 25°C  | 38                 | A        |
| E <sub>AS</sub>   | T <sub>C</sub> = 25°C  | 500                | mJ       |
| dv/dt             | I <sub>S</sub> ≤ I <sub>DM</sub> , V <sub>DD</sub> ≤ V <sub>DSS</sub> , T <sub>J</sub> ≤ 175°C | 15                 | V/ns     |
| P <sub>D</sub>    | T <sub>C</sub> = 25°C  | 350                | W        |
| T <sub>J</sub>    |  | -55 ... +175       | °C       |
| T <sub>JM</sub>   |  | 175                | °C       |
| T <sub>stg</sub>  |  | -55 ... +175       | °C       |
| T <sub>L</sub>    | Maximum Lead Temperature for Soldering   | 300                | °C       |
| T <sub>SOLD</sub> | Plastic Body for 10s   | 260                | °C       |
| F <sub>C</sub>    | Mounting Force (TO-263)  | 10..65 / 2.2..14.6 | N/lb     |
| M <sub>d</sub>    | Mounting Torque (TO-220 & TO-247)  | 1.13 / 10          | Nm/lb.in |
| Weight            | TO-263   | 2.5                | g        |
|                   | TO-220   | 3.0                | g        |
|                   | TO-247   | 6.0                | g        |

| Symbol              | Test Conditions<br>(T <sub>J</sub> = 25°C Unless Otherwise Specified)               | Characteristic Values |      |         |
|---------------------|---|-----------------------|------|---------|
|                     |   | Min.                  | Typ. | Max.    |
| BV <sub>DSS</sub>   | V <sub>GS</sub> = 0V, I <sub>D</sub> = 250μA  | 150                   |      | V       |
| V <sub>GS(th)</sub> | V <sub>DS</sub> = V <sub>GS</sub> , I <sub>D</sub> = 250μA                          | 2.5                   |      | 4.5 V   |
| I <sub>GSS</sub>    | V <sub>GS</sub> = ± 20V, V <sub>DS</sub> = 0V                                       |                       |      | ±200 nA |
| I <sub>DSS</sub>    | V <sub>DS</sub> = V <sub>DSS</sub> , V <sub>GS</sub> = 0V<br>T <sub>J</sub> = 150°C |                       |      | 5 μA    |
|                     |   |                       |      | 750 μA  |
| R <sub>DS(on)</sub> | V <sub>GS</sub> = 10V, I <sub>D</sub> = 0.5 • I <sub>D25</sub> , Notes 1, 2         |                       |      | 22 mΩ   |

TO-263  
(IXFA)

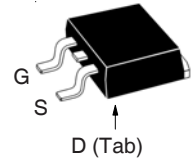

TO-220  
(IXFP)

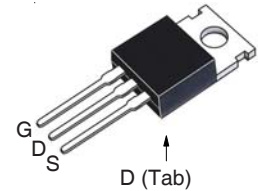

TO-247  
(IXFH)

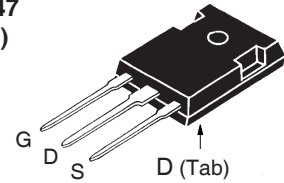

G = Gate      D = Drain  
S = Source    Tab = Drain

## Features

- International Standard Packages
- 175°C Operating Temperature
- High Current Handling Capability
- Fast Intrinsic Rectifier
- Dynamic dv/dt Rated
- Low R<sub>DS(on)</sub>

## Advantages

- Easy to Mount
- Space Savings
- High Power Density

## Applications

- DC-DC Converters
- Battery Chargers
- Switch-Mode and Resonant-Mode Power Supplies
- DC Choppers
- AC Motor Drives
- Uninterruptible Power Supplies
- High Speed Power Switching Applications

| Symbol       | Test Conditions<br>( $T_J = 25^\circ\text{C}$ , Unless Otherwise Specified)  | Characteristic Values |      |                         |
|--------------|--|-----------------------|------|-------------------------|
|              |  | Min.                  | Typ. | Max.                    |
| $g_{fs}$     | $V_{DS} = 10\text{V}$ , $I_D = 0.5 \cdot I_{D25}$ , Note 1   | 50                    | 80   | S                       |
| $C_{iss}$    | $V_{GS} = 0\text{V}$ , $V_{DS} = 25\text{V}$ , $f = 1\text{MHz}$   |                       | 5800 | pF                      |
| $C_{oss}$    |  |                       | 490  | pF                      |
| $C_{rss}$    |  |                       | 85   | pF                      |
| $t_{d(on)}$  | <b>Resistive Switching Times</b><br>$V_{GS} = 10\text{V}$ , $V_{DS} = 0.5 \cdot V_{DSS}$ , $I_D = 0.5 \cdot I_{D25}$<br>$R_G = 5\Omega$ (External) |                       | 17   | ns                      |
| $t_r$        |  |                       | 19   | ns                      |
| $t_{d(off)}$ |  |                       | 25   | ns                      |
| $t_f$        |  |                       | 14   | ns                      |
| $Q_{g(on)}$  | $V_{GS} = 10\text{V}$ , $V_{DS} = 0.5 \cdot V_{DSS}$ , $I_D = 0.5 \cdot I_{D25}$   |                       | 97   | nC                      |
| $Q_{gs}$     |  |                       | 29   | nC                      |
| $Q_{gd}$     |  |                       | 30   | nC                      |
| $R_{thJC}$   |  |                       |      | 0.43 $^\circ\text{C/W}$ |
| $R_{thCS}$   | TO-220   |                       | 0.50 | $^\circ\text{C/W}$      |
|              | TO-247   |                       | 0.21 | $^\circ\text{C/W}$      |

**Source-Drain Diode**

| Symbol   | Test Conditions<br>( $T_J = 25^\circ\text{C}$ , Unless Otherwise Specified)                           | Characteristic Values |      |       |
|----------|---|-----------------------|------|-------|
|          |   | Min.                  | Typ. | Max.  |
| $I_S$    | $V_{GS} = 0\text{V}$  |                       |      | 76 A  |
| $I_{SM}$ | Repetitive, Pulse Width Limited by $T_{JM}$   |                       |      | 300 A |
| $V_{SD}$ | $I_F = 38\text{A}$ , $V_{GS} = 0\text{V}$ , Note 1  |                       |      | 1.5 V |
| $t_{rr}$ | $I_F = 38\text{A}$ , $V_{GS} = 0\text{V}$<br>$-di/dt = 100\text{A}/\mu\text{s}$<br>$V_R = 75\text{V}$ |                       | 69   | ns    |
| $I_{RM}$ |   |                       | 5.7  | A     |
| $Q_{RM}$ |   |                       | 197  | nC    |

- Notes: 1. Pulse test,  $t \leq 300\mu\text{s}$ , duty cycle,  $d \leq 2\%$ .  
2. On through-hole packages,  $R_{DS(on)}$  Kelvin test contact location must be 5mm or less from the package body.

IXYS Reserves the Right to Change Limits, Test Conditions, and Dimensions.

Fig. 1. Output Characteristics @  $T_J = 25^\circ\text{C}$

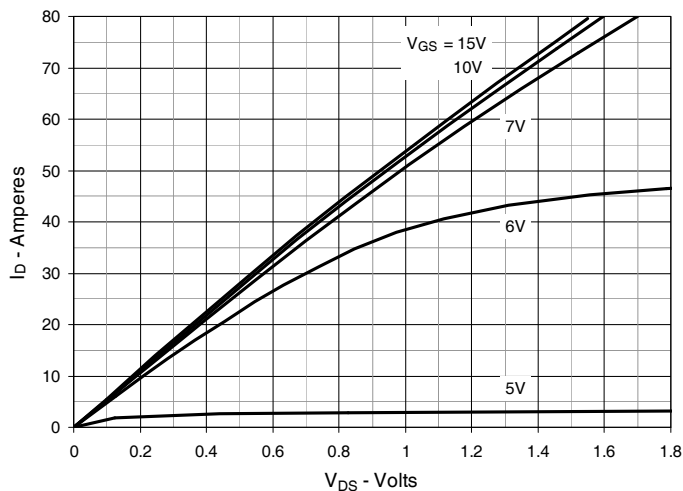

Fig. 2. Extended Output Characteristics @  $T_J = 25^\circ\text{C}$

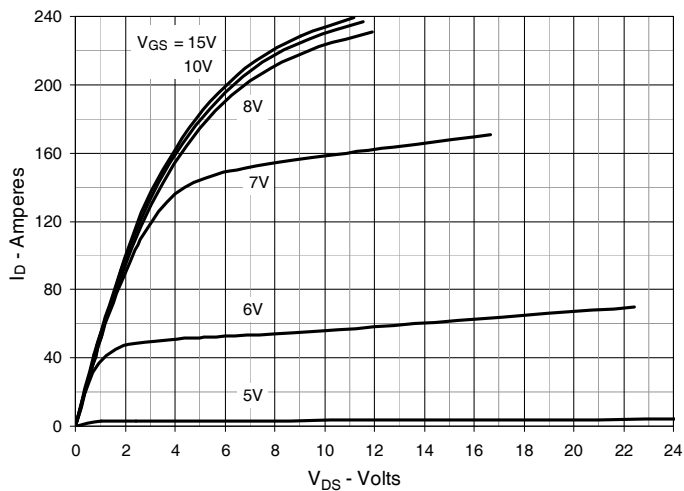

Fig. 3. Output Characteristics @  $T_J = 150^\circ\text{C}$

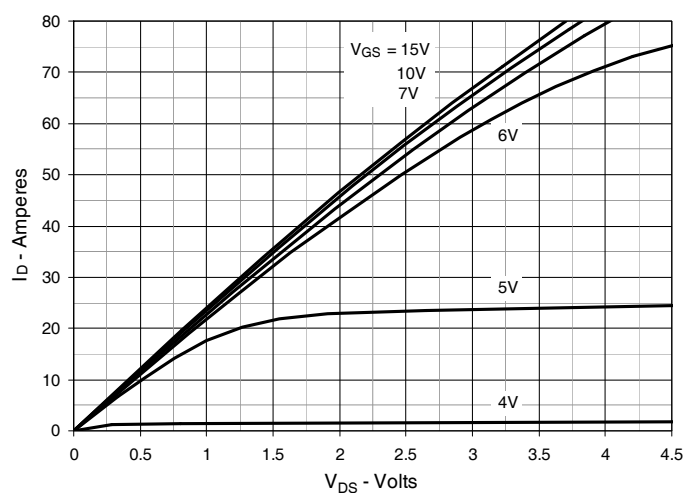

Fig. 4.  $R_{DS(on)}$  Normalized to  $I_D = 38\text{A}$  Value vs. Junction Temperature

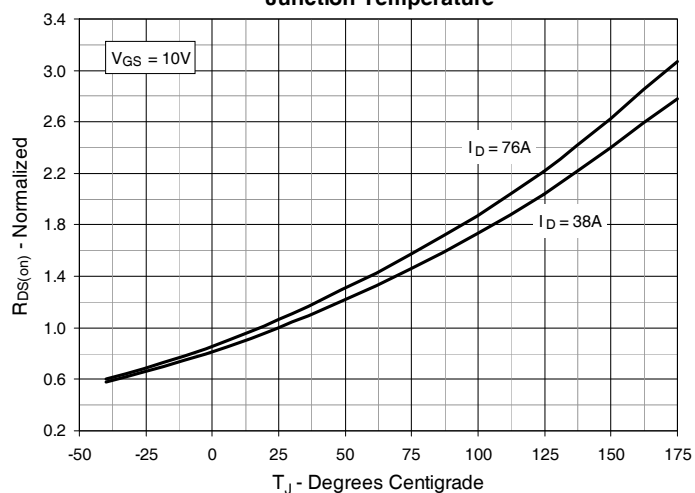

Fig. 5.  $R_{DS(on)}$  Normalized to  $I_D = 38\text{A}$  Value vs. Drain Current

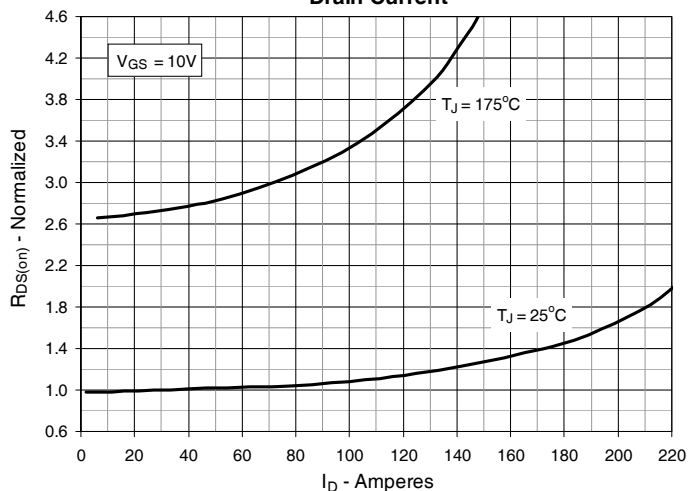

Fig. 6. Drain Current vs. Case Temperature

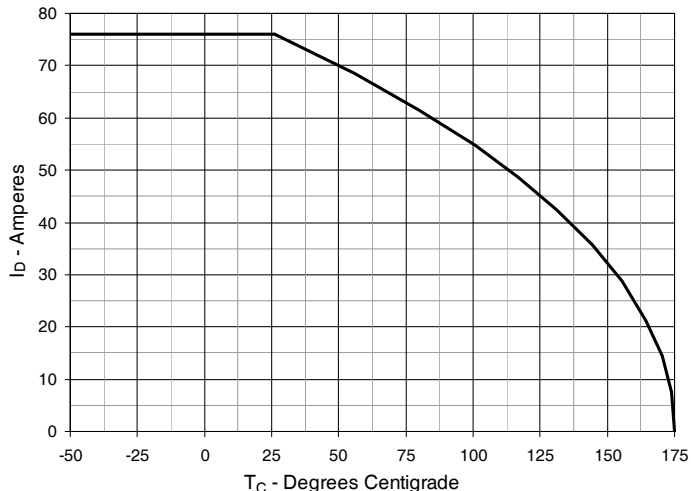

Fig. 7. Input Admittance

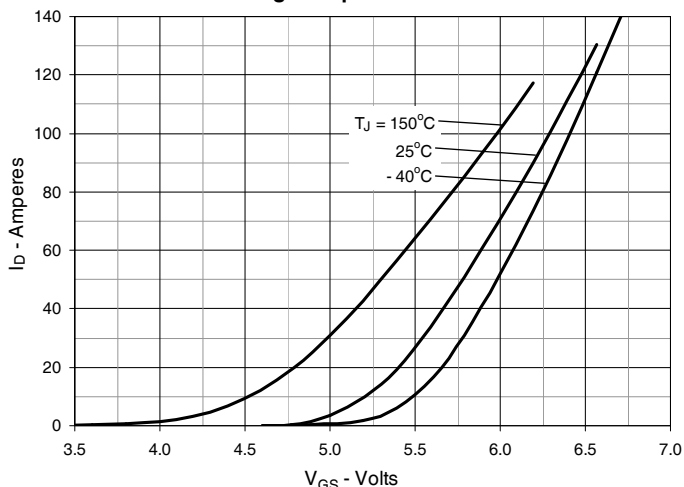

Fig. 8. Transconductance

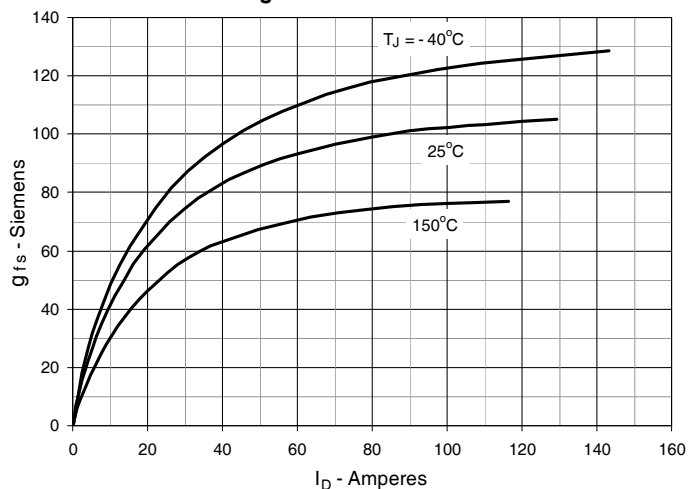

Fig. 9. Forward Voltage Drop of Intrinsic Diode

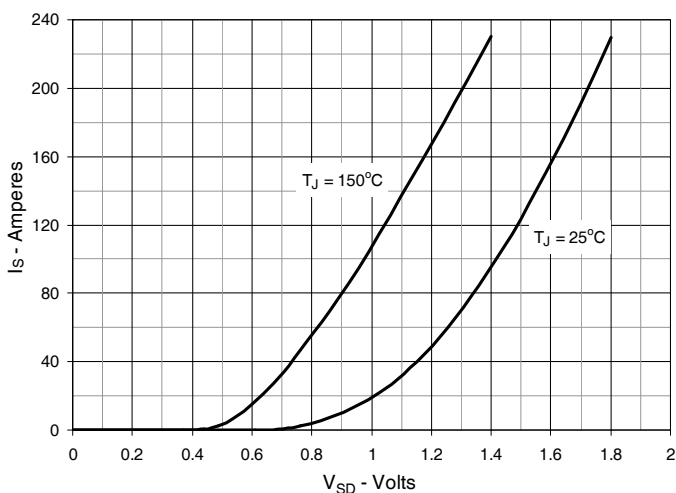

Fig. 10. Gate Charge

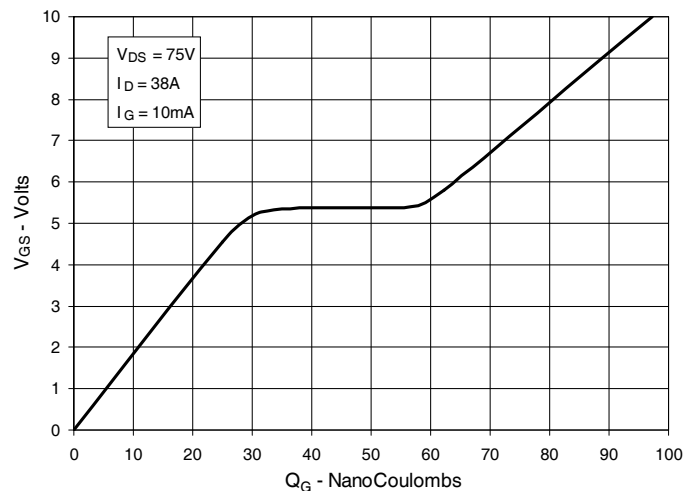

Fig. 11. Capacitance

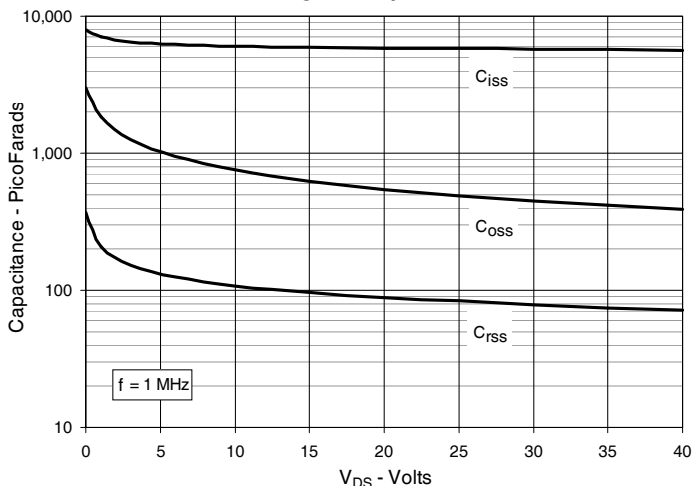
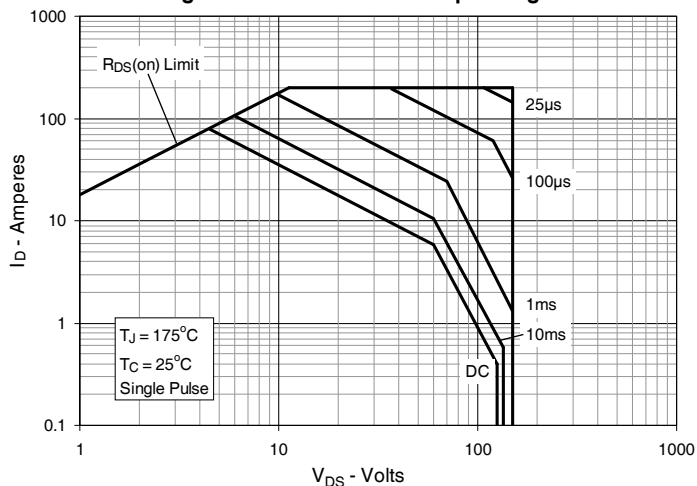
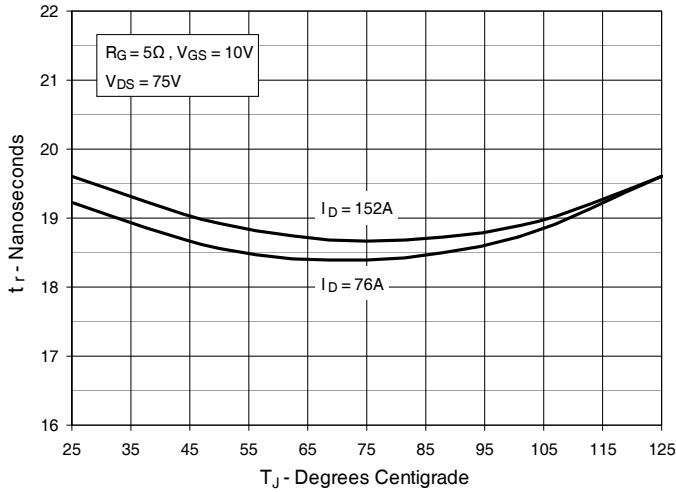

Fig. 12. Forward-Bias Safe Operating Area



**Fig. 13. Resistive Turn-on Rise Time vs. Junction Temperature**



**Fig. 14. Resistive Turn-on Rise Time vs. Drain Current**

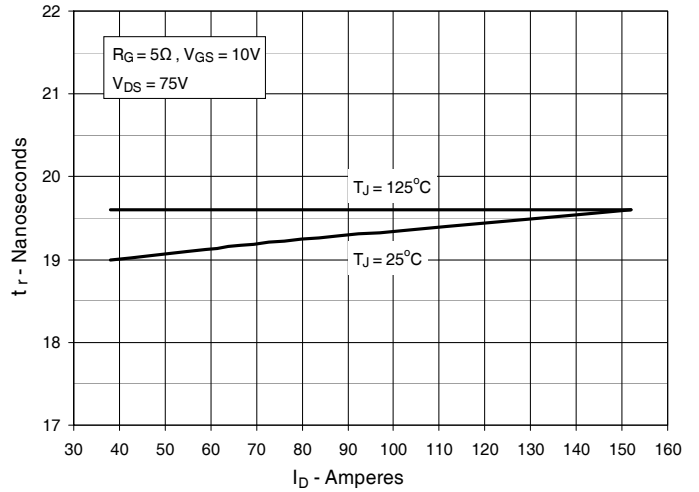

**Fig. 15. Resistive Turn-on Switching Times vs. Gate Resistance**

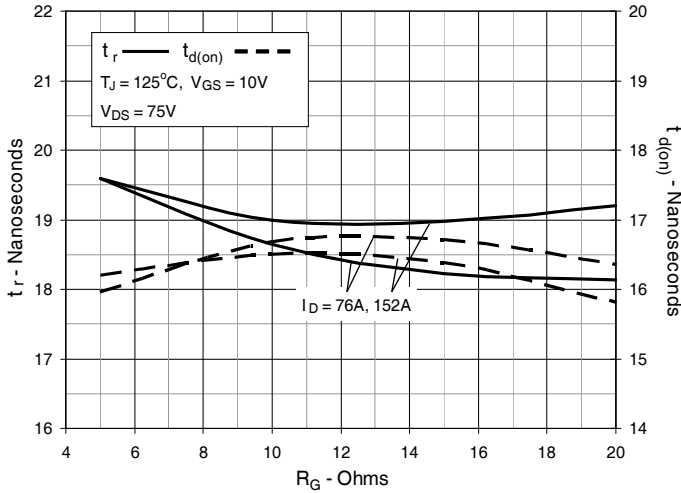

**Fig. 16. Resistive Turn-off Switching Times vs. Junction Temperature**

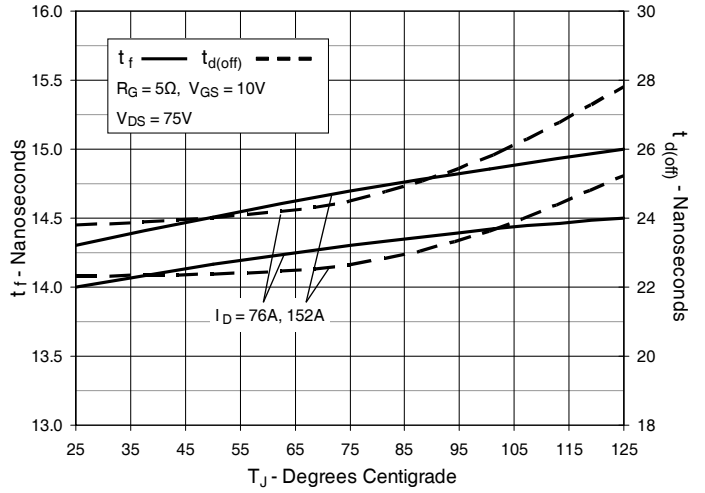

**Fig. 17. Resistive Turn-off Switching Times vs. Drain Current**

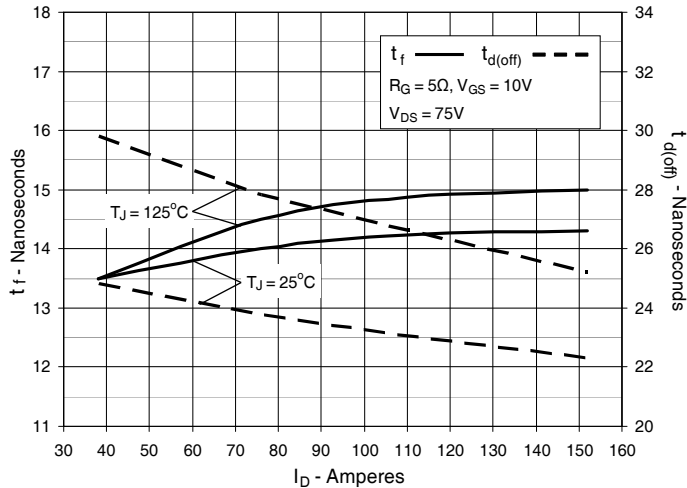

**Fig. 18. Resistive Turn-off Switching Times vs. Gate Resistance**

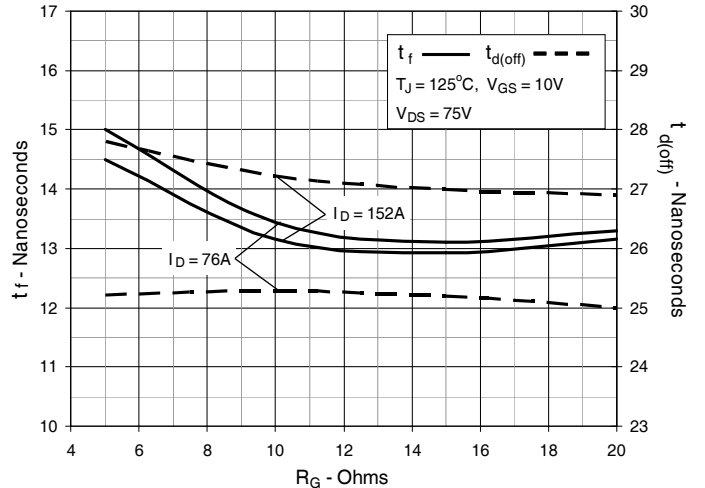
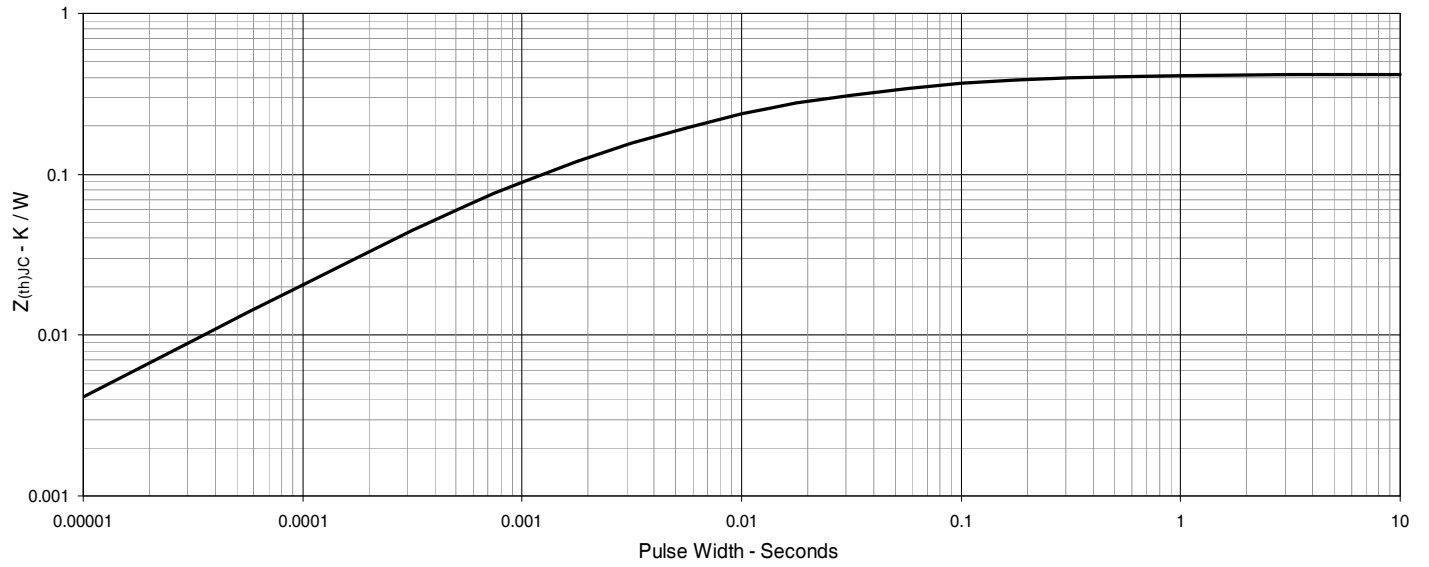
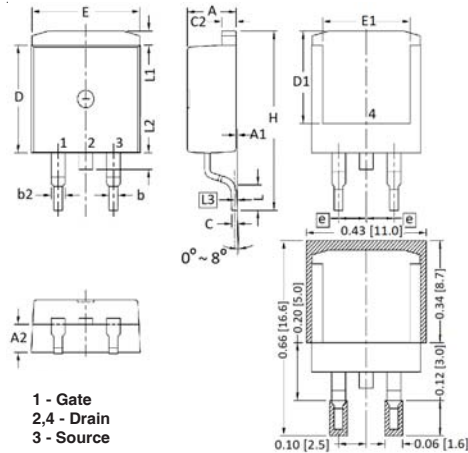
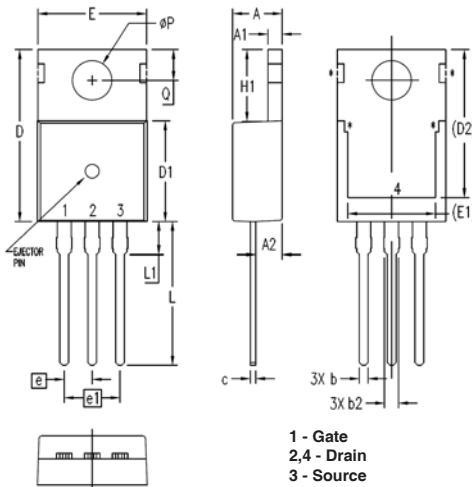

Fig. 19. Maximum Transient Thermal Impedance



**TO-263 Outline**

| SYM | INCHES   |      | MILLIMETER |       |
|-----|----------|------|------------|-------|
|     | MIN      | MAX  | MIN        | MAX   |
| A   | .170     | .185 | 4.30       | 4.70  |
| A1  | .000     | .008 | 0.00       | 0.20  |
| A2  | .091     | .098 | 2.30       | 2.50  |
| b   | .028     | .035 | 0.70       | 0.90  |
| b2  | .046     | .060 | 1.18       | 1.52  |
| C   | .018     | .024 | 0.45       | 0.60  |
| C2  | .049     | .060 | 1.25       | 1.52  |
| D   | .340     | .370 | 8.63       | 9.40  |
| D1  | .300     | .327 | 7.62       | 8.30  |
| E   | .380     | .410 | 9.65       | 10.41 |
| E1  | .270     | .330 | 6.86       | 8.38  |
| e   | .100 BSC |      | 2.54 BSC   |       |
| H   | .580     | .620 | 14.73      | 15.75 |
| L   | .075     | .105 | 1.91       | 2.67  |
| L1  | .039     | .060 | 1.00       | 1.52  |
| L2  | —        | .070 | —          | 1.77  |
| L3  | .010 BSC |      | 0.254 BSC  |       |

**TO-220 Outline**

| SYM  | INCHES   |      | MILLIMETERS |       |
|------|----------|------|-------------|-------|
|      | MIN      | MAX  | MIN         | MAX   |
| A    | .169     | .185 | 4.30        | 4.70  |
| A1   | .047     | .055 | 1.20        | 1.40  |
| A2   | .079     | .106 | 2.00        | 2.70  |
| b    | .024     | .039 | 0.60        | 1.00  |
| b2   | .045     | .057 | 1.15        | 1.45  |
| c    | .014     | .026 | 0.35        | 0.65  |
| D    | .587     | .626 | 14.90       | 15.90 |
| D1   | .335     | .370 | 8.50        | 9.40  |
| (D2) | .500     | .531 | 12.70       | 13.50 |
| E    | .382     | .406 | 9.70        | 10.30 |
| (E1) | .283     | .323 | 7.20        | 8.20  |
| e    | .100 BSC |      | 2.54 BSC    |       |
| e1   | .200 BSC |      | 5.08 BSC    |       |
| H1   | .244     | .268 | 6.20        | 6.80  |
| L    | .492     | .547 | 12.50       | 13.90 |
| L1   | .110     | .154 | 2.80        | 3.90  |
| ∅P   | .134     | .150 | 3.40        | 3.80  |
| Q    | .106     | .126 | 2.70        | 3.20  |

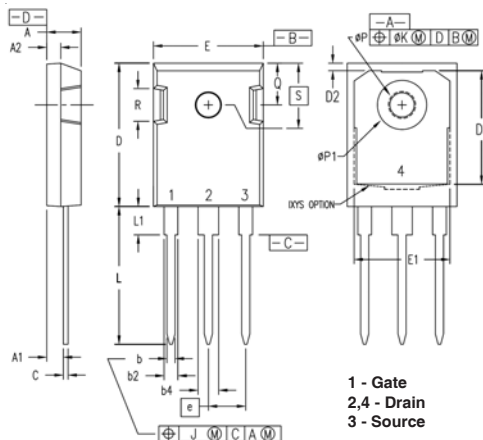
**TO-247 Outline**

| SYM | INCHES   |      | MILLIMETERS |       |
|-----|----------|------|-------------|-------|
|     | MIN      | MAX  | MIN         | MAX   |
| A   | .190     | .205 | 4.83        | 5.21  |
| A1  | .090     | .100 | 2.29        | 2.54  |
| A2  | .075     | .085 | 1.91        | 2.16  |
| b   | .045     | .055 | 1.14        | 1.40  |
| b2  | .075     | .087 | 1.91        | 2.20  |
| b4  | .115     | .126 | 2.92        | 3.20  |
| C   | .024     | .031 | 0.61        | 0.80  |
| D   | .819     | .840 | 20.80       | 21.34 |
| D1  | .650     | .690 | 16.51       | 17.53 |
| D2  | .035     | .050 | 0.89        | 1.27  |
| E   | .620     | .635 | 15.75       | 16.13 |
| E1  | .545     | .565 | 13.84       | 14.35 |
| e   | .215 BSC |      | 5.45 BSC    |       |
| J   | --       | .010 | --          | 0.25  |
| K   | --       | .025 | --          | 0.64  |
| L   | .780     | .810 | 19.81       | 20.57 |
| L1  | .150     | .170 | 3.81        | 4.32  |
| ∅P  | .140     | .144 | 3.55        | 3.65  |
| ∅P1 | .275     | .290 | 6.99        | 7.37  |
| Q   | .220     | .244 | 5.59        | 6.20  |
| R   | .170     | .190 | 4.32        | 4.83  |
| S   | .242 BSC |      | 6.15 BSC    |       |



---

Disclaimer Notice - Information furnished is believed to be accurate and reliable. However, users should independently evaluate the suitability of and test each product selected for their own applications. Littelfuse products are not designed for, and may not be used in, all applications. Read complete Disclaimer Notice at [www.littelfuse.com/disclaimer-electronics](http://www.littelfuse.com/disclaimer-electronics).



## X-ON Electronics

Largest Supplier of Electrical and Electronic Components

*Click to view similar products for [MOSFET](#) category:*

*Click to view products by [IXYS](#) manufacturer:*

Other Similar products are found below :

[614233C](#) [648584F](#) [MCH3443-TL-E](#) [MCH6422-TL-E](#) [FDPF9N50NZ](#) [FW216A-TL-2W](#) [FW231A-TL-E](#) [APT5010JVR](#) [NTNS3A92PZT5G](#)  
[IRF100S201](#) [JANTX2N5237](#) [2SK2464-TL-E](#) [2SK3818-DL-E](#) [FCA20N60\\_F109](#) [FDZ595PZ](#) [STD6600NT4G](#) [FSS804-TL-E](#) [2SJ277-DL-E](#)  
[2SK1691-DL-E](#) [2SK2545\(Q,T\)](#) [405094E](#) [423220D](#) [MCH6646-TL-E](#) [TPCC8103,L1Q\(CM](#) [367-8430-0972-503](#) [VN1206L](#) [424134F](#)  
[026935X](#) [051075F](#) [SBVS138LT1G](#) [614234A](#) [715780A](#) [NTNS3166NZT5G](#) [751625C](#) [873612G](#) [IRF7380TRHR](#) [IPS70R2K0CEAKMA1](#)  
[RJK60S3DPP-E0#T2](#) [RJK60S5DPK-M0#T0](#) [APT5010JVFR](#) [APT12031JFLL](#) [APT12040JVR](#) [DMN3404LQ-7](#) [NTE6400](#) [JANTX2N6796U](#)  
[JANTX2N6784U](#) [JANTXV2N5416U4](#) [SQM110N05-06L-GE3](#) [SIHF35N60E-GE3](#) [2SK2614\(TE16L1,Q\)](#)