

SiC Power MOSFET

preliminary

I_{D25}	=	68 A
V_{DSS}	=	1200 V
$R_{DS(on) max}$	=	34 mΩ

Kelvin Source gate connection

Part number
IXFN70N120SK

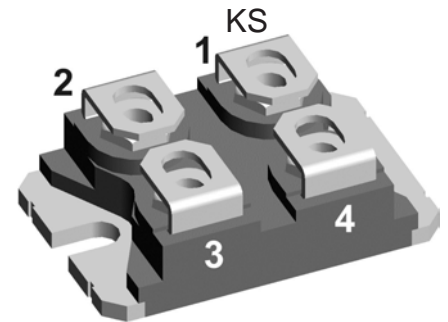
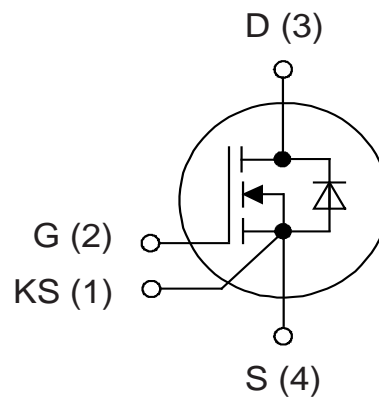
 Backside: isolated
UL pending

Features / Advantages:

- High speed switching with low capacitances
- High blocking voltage with low $R_{DS(on)}$
- Easy to parallel and simple to drive
- Resistant to latch-up
- Real Kelvin source connection

Applications:

- Solar inverters
- High voltage DC/DC converters
- Motor drives
- Switch mode power supplies
- UPS
- Battery chargers
- Induction heating

Package: SOT-227B (minibloc)

- Isolation Voltage: 3000 V~
- Industry standard outline
- RoHS compliant
- Epoxy meets UL 94V-0
- Base plate with Aluminium nitride isolation
- Advanced power cycling

Terms & Conditions of usage

The data contained in this product data sheet is exclusively intended for technically trained staff. The user will have to evaluate the suitability of the product for the intended application and the completeness of the product data with respect to his application. The specifications of our components may not be considered as an assurance of component characteristics. The information in the valid application- and assembly notes must be considered. Should you require product information in excess of the data given in this product data sheet or which concerns the specific application of your product, please contact your local sales office.

Due to technical requirements our product may contain dangerous substances. For information on the types in question please contact your local sales office.

Should you intend to use the product in aviation, in health or life endangering or life support applications, please notify. For any such application we urgently recommend

- to perform joint risk and quality assessments;

- the conclusion of quality agreements;

- to establish joint measures of an ongoing product survey, and that we may make delivery dependent on the realization of any such measures.

IXYS reserves the right to change limits, test conditions and dimensions.

20180405a

MOSFET			Ratings			
Symbol	Definitions	Conditions	min.	typ.	max.	
V_{DSS}	drain source breakdown voltage	$V_{GS} = 0\text{ V}$, $I_D = 100\ \mu\text{A}$	1200			V
V_{GSM}	max transient gate source voltage		-10		+25	V
V_{GS}	continuous gate source voltage	recommended operational value	-5		+20	V
I_{D25}	drain current	$V_{GS} = 20\text{ V}$			68	A
I_{D80}					55	A
I_{D100}					48	A
R_{DSon}	static drain source on resistance	$I_D = 50\text{ A}$; $V_{GS} = 20\text{ V}$		25 52	34	mΩ mΩ
$V_{GS(th)}$	gate threshold voltage	$I_D = 15\text{ mA}$; $V_{GS} = V_{DS}$	2.0	2.6 2.1	4.0	V V
I_{DSS}	drain source leakage current	$V_{DS} = 1200\text{ V}$; $V_{GS} = 0\text{ V}$		2	100	μA
I_{GSS}	gate source leakage current	$V_{DS} = 0\text{ V}$; $V_{GS} = 20\text{ V}$			0.6	μA
R_G	internal gate resistance	$f = 1\text{ MHz}$, $V_{AC} = 25\text{ mV}$, ESR of C_{ISS}		1.1		Ω
C_{ISS}	input capacitance			2790		pF
C_{OSS}	output capacitance	$V_{DS} = 1000\text{ V}$; $V_{GS} = 0\text{ V}$; $f = 1\text{ MHz}$		220		pF
C_{RSS}	reverse transfer (Miller) capacitance	$T_{VJ} = 25^\circ\text{C}$		15		pF
Q_g	total gate charge			161		nC
Q_{gs}	gate source charge	$V_{DS} = 800\text{ V}$; $I_D = 50\text{ A}$; $V_{GS} = -5/20\text{ V}$		46		nC
Q_{gd}	gate drain (Miller) charge	$T_{VJ} = 25^\circ\text{C}$		50		nC
$t_{d(on)}$	turn-on delay time			30		ns
t_r	current rise time	Inductive switching		15		ns
$t_{d(off)}$	turn-off delay time	$V_{DS} = 800\text{ V}$; $I_D = 50\text{ A}$		82		ns
t_f	current fall time	$T_{VJ} = 25^\circ\text{C}$		27		ns
E_{on}	turn-on energy per pulse	$V_{GS} = -5 / 20\text{ V}$; $R_G = 15\ \Omega$ (external)		1.35		mJ
E_{off}	turn-off energy per pulse	Freewheeling diode is Mosfet's body diode		0.76		mJ
$E_{rec(off)}$	reverse recovery losses at turn-off			0.13		mJ
$t_{d(on)}$	turn-on delay time			28		ns
t_r	current rise time	Inductive switching		12		ns
$t_{d(off)}$	turn-off delay time	$V_{DS} = 800\text{ V}$; $I_D = 50\text{ A}$		125		ns
t_f	current fall time	$T_{VJ} = 150^\circ\text{C}$		28		ns
E_{on}	turn-on energy per pulse	$V_{GS} = -5 / 20\text{ V}$; $R_G = 15\ \Omega$ (external)		1.71		mJ
E_{off}	turn-off energy per pulse	Freewheeling diode is Mosfet's body diode		0.78		mJ
$E_{rec(off)}$	reverse recovery losses at turn-off			0.29		mJ
R_{thJC}	thermal resistance junction to case				0.45	K/W
R_{thJH}	thermal resistance junction to heatsink	with heatsink compound; IXYS test setup		0.6		K/W

Source-Drain Diode			Ratings			
Symbol	Definitions	Conditions	min.	typ.	max.	
V_{SD}	forward voltage drop	$I_F = 50\text{ A}$; $V_{GS} = -5\text{ V}$		4.3 3.7		V V
t_{rr}	reverse recovery time	$V_{GS} = -5\text{ V}$; $I_F = 50\text{ A}$; $V_R = 800\text{ V}$		35		ns
Q_{RM}	reverse recovery charge (intrinsic diode)	Mosfet gate drive:		0.52		μC
I_{RM}	max. reverse recovery current	$V_{GS} = -5 / 20\text{ V}$; $R_G = 15\ \Omega$		33		A
dI_F/dt	current slew rate			3380		A/μs
t_{rr}	reverse recovery time	$V_{GS} = -5\text{ V}$; $I_F = 50\text{ A}$; $V_R = 800\text{ V}$		30		ns
Q_{RM}	reverse recovery charge (intrinsic diode)	Mosfet gate drive:		1.23		μC
I_{RM}	max. reverse recovery current	$V_{GS} = -5 / 20\text{ V}$; $R_G = 15\ \Omega$		59		A
dI_F/dt	current slew rate			4250		A/μs

Note:

 When using SiC Body Diode the maximum recommended $V_{GS} = -5\text{V}$

Package SOT-227B (minibloc)

Symbol	Definitions	Conditions	Ratings			Unit
			min.	typ.	max.	
I_{RMS}	RMS current	per terminal				A
T_{stg}	storage temperature		-40		150	°C
T_{op}	operation temperature		-40		150	°C
T_{vJ}	virtual junction temperature		-40		175	°C
Weight				30		g
M_D	mounting torque		1.1		1.5	Nm
M_T	terminal torque		1.1		1.5	Nm
$d_{Spp/App}$	creepage distance on surface striking distance through air	terminal to backside	10.5 / 3.2			mm
$d_{Spb/Appb}$		terminal to terminal	8.6 / 6.8			mm
V_{ISOL}	isolation voltage	$I_{ISOL} \leq 1 \text{ mA}; 50/60 \text{ Hz},$				V
		t = 1 sec.	3000			V
		t = 1 minute	2500			V

Product Marking

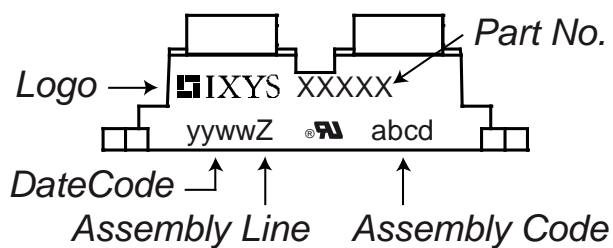

Ordering	Part Name	Marking on Product	Delivering Mode	Base Qty	Ordering Code
Standard	IXFN70N120SK	IXFN70N120SK	Tube	10	517981

Outlines SOT-227B (minibloc)

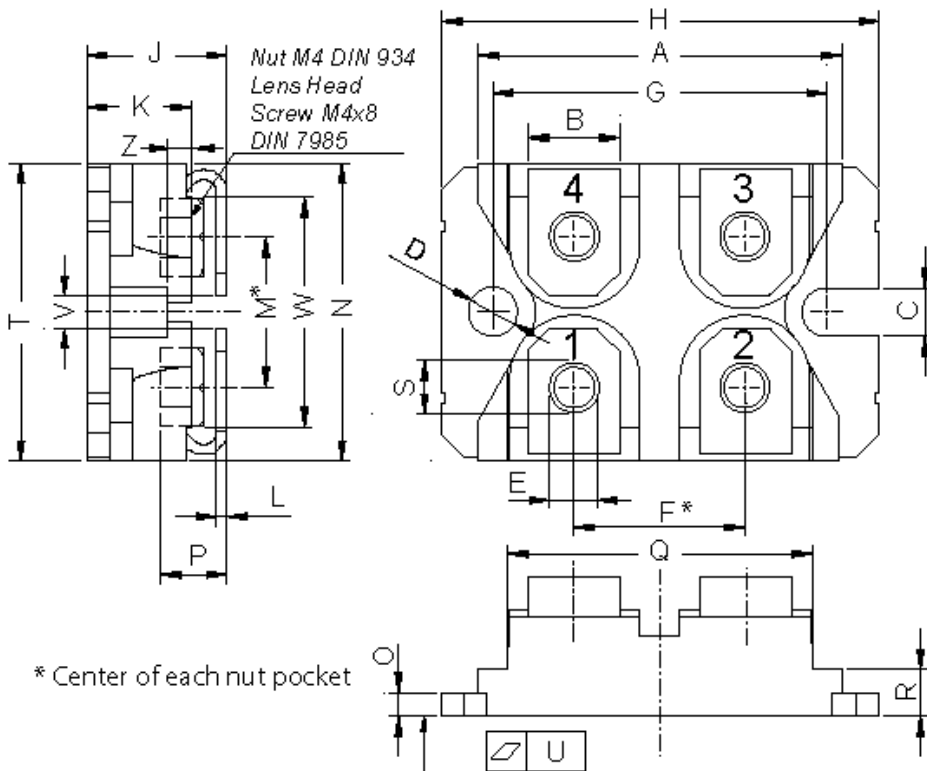

Dim.	Millimeter		Inches	
	min	max	min	max
A	31.50	31.88	1.240	1.255
B	7.80	8.20	0.307	0.323
C	4.09	4.29	0.161	0.169
D	4.09	4.29	0.161	0.169
E	4.09	4.29	0.161	0.169
F	14.91	15.11	0.587	0.595
G	30.12	30.30	1.186	1.193
H	37.80	38.23	1.488	1.505
J	11.68	12.22	0.460	0.481
K	8.92	9.60	0.351	0.378
L	0.74	0.84	0.029	0.033
M	12.50	13.10	0.492	0.516
N	25.15	25.42	0.990	1.001
O	1.95	2.13	0.077	0.084
P	4.95	6.20	0.195	0.244
Q	26.54	26.90	1.045	1.059
R	3.94	4.42	0.155	0.167
S	4.55	4.85	0.179	0.191
T	24.59	25.25	0.968	0.994
U	-0.05	0.10	-0.002	0.004
V	3.20	5.50	0.126	0.217
W	19.81	21.08	0.780	0.830
Z	2.50	2.70	0.098	0.106

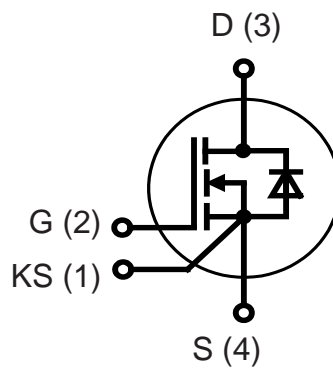

Curves

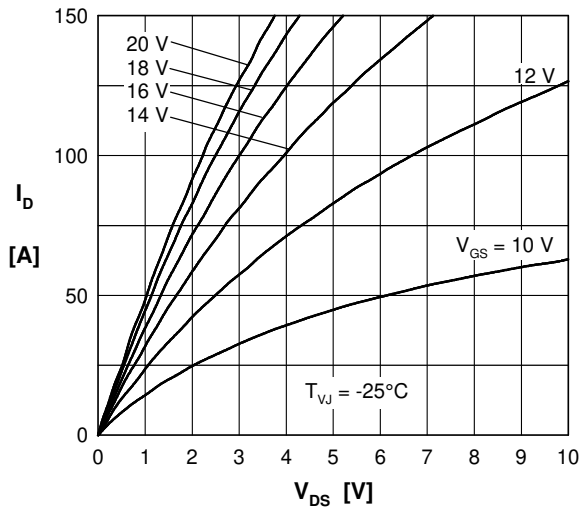

Fig. 1 Typical output characteristics (-25°C)

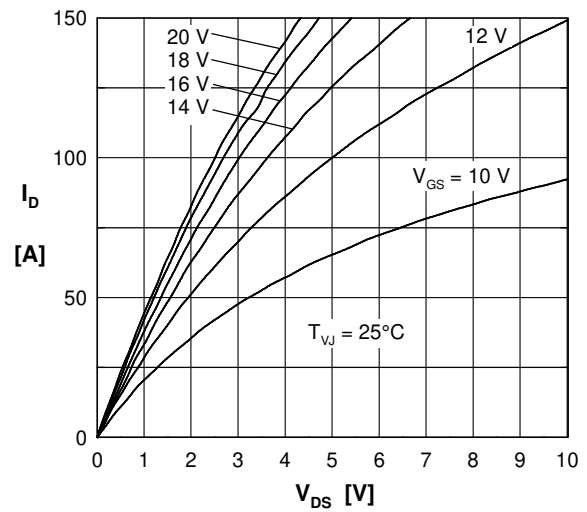

Fig. 2 Typical output characteristics (25°C)

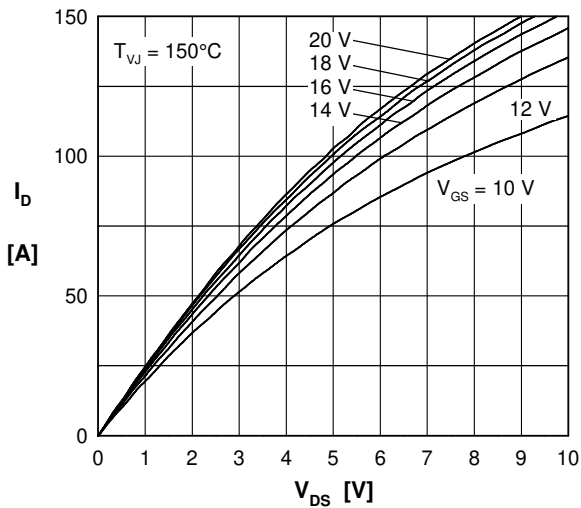

Fig. 3 Typical output characteristics (150°C)

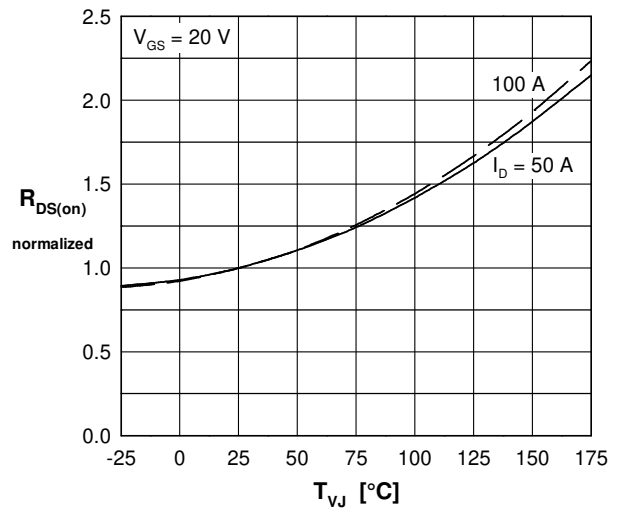

Fig. 4 $R_{DS(on)}$ normalized vs. junction temperature T_{VJ}

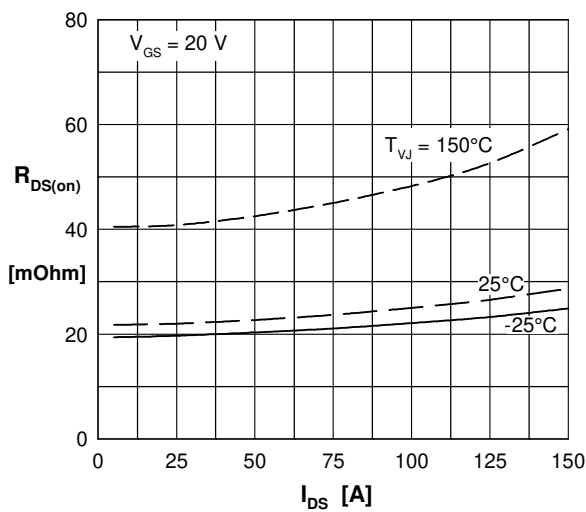

Fig. 5 $R_{DS(on)}$ versus drain current

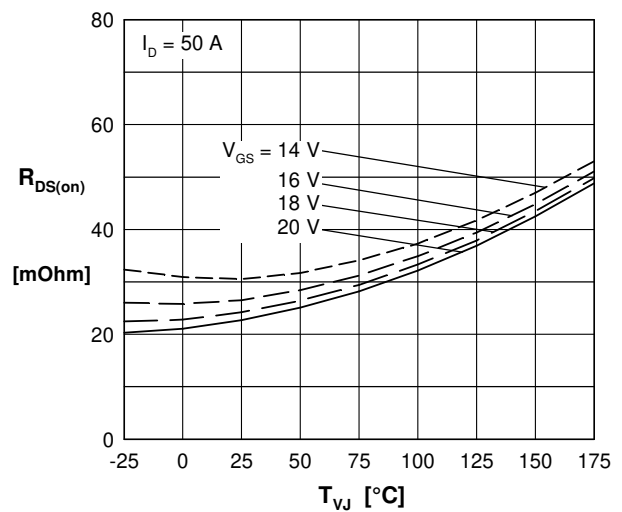

Fig. 6 $R_{DS(on)}$ versus junction temperature T_{VJ}

Curves

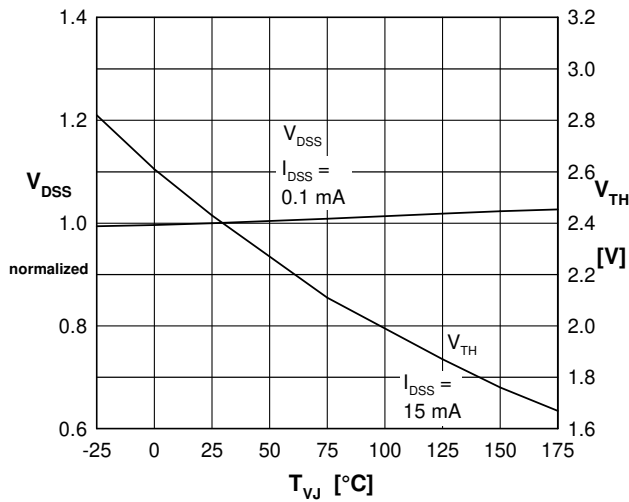

Fig. 7 Norm. breakdow V_{DSS} & treshhold voltage V_{TH} versus junction temperature T_{VJ}

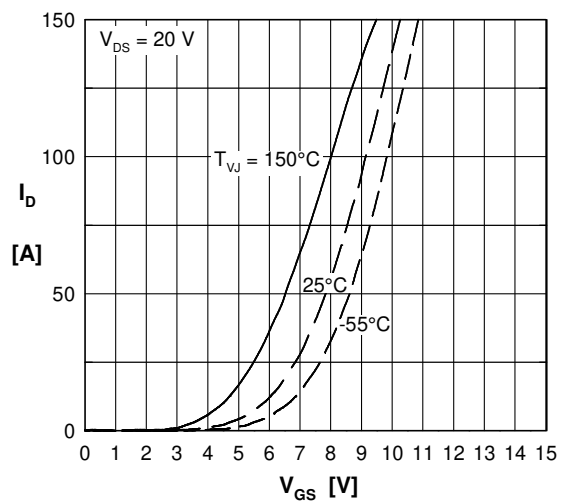

Fig. 8 Typical transfer characteristics

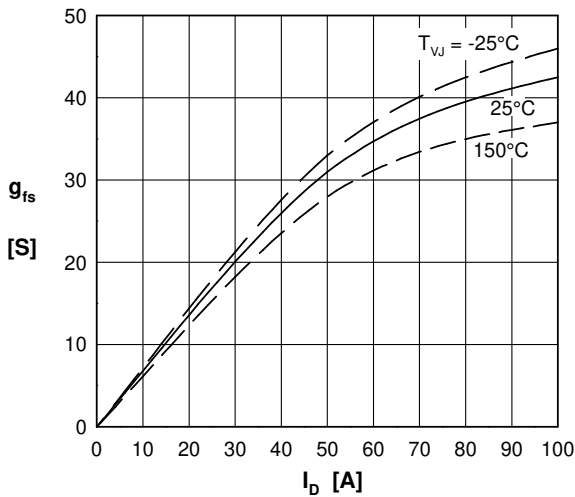

Fig. 9 Typical forward transconductance

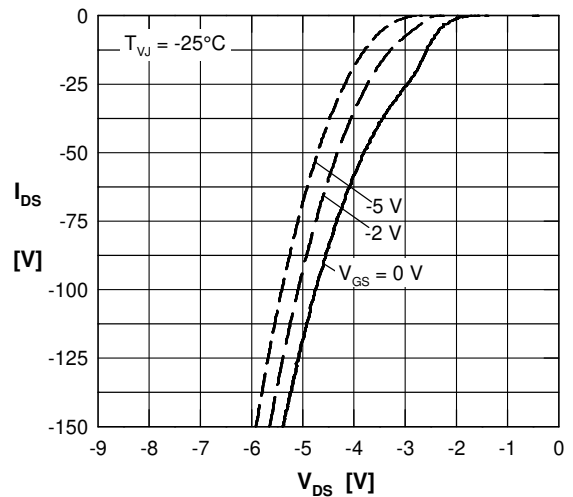

Fig. 10 Forward voltage drop of intrinsic diode versus V_{DS} measured at -55°C

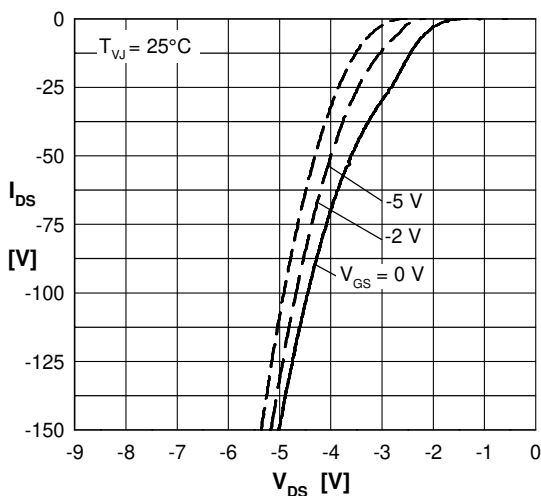

Fig. 11 Forward voltage drop of intrinsic diode versus V_{DS} measured at 25°C

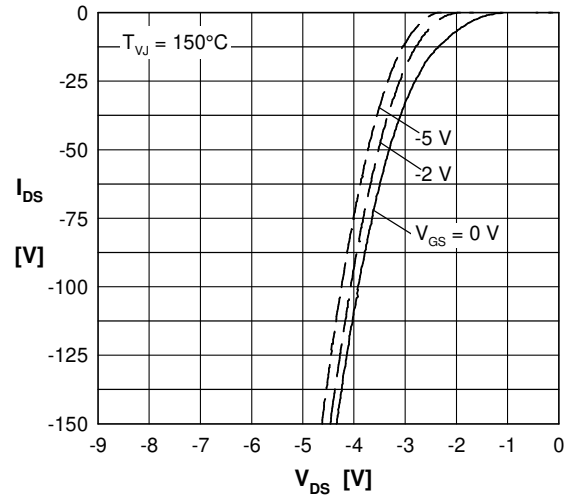

Fig. 12 Forward voltage drop of intrinsic diode versus V_{DS} measured at 150°C

Curves

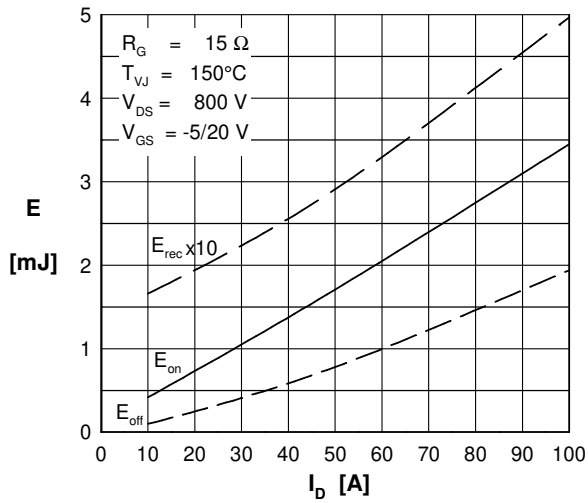

Fig. 13 Typical switching energy versus drain current

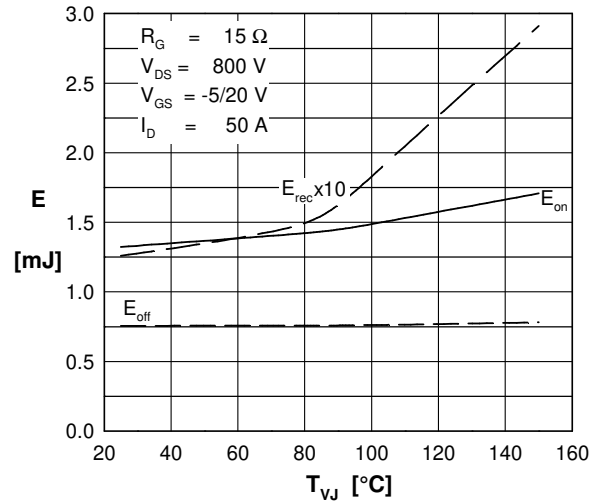

Fig. 14 Typical switching energy versus temperature

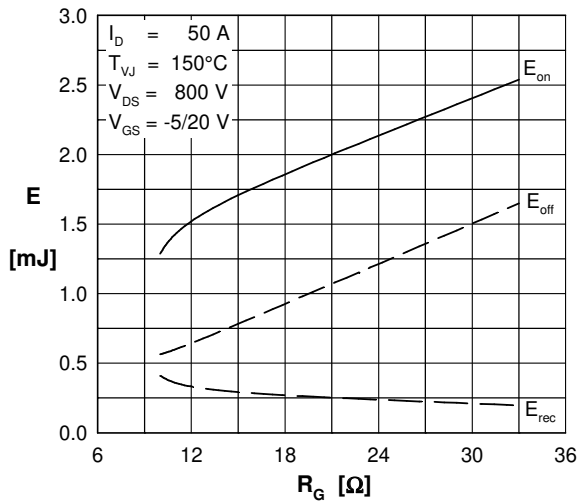

Fig. 15 Typical switching energy versus external gate resistor

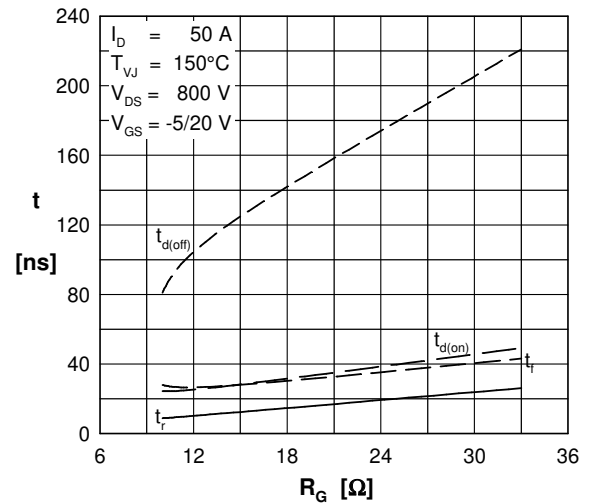

Fig. 16 Typical switching time versus external gate resistor

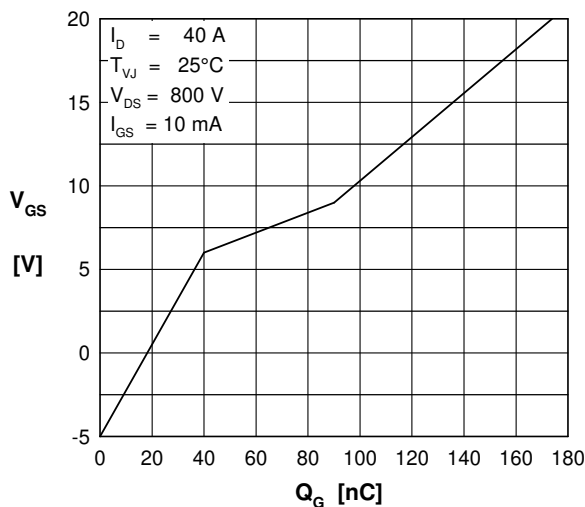

Fig. 17 Typical turn on gate charge, trendline

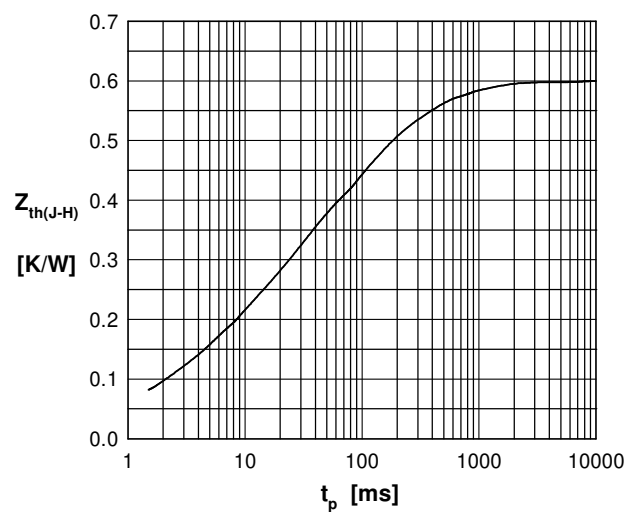

Fig. 18 Typical transient thermal impedance

X-ON Electronics

Largest Supplier of Electrical and Electronic Components

Click to view similar products for [Discrete Semiconductor Modules](#) category:

Click to view products by [IXYS](#) manufacturer:

Other Similar products are found below :

[M252511FV](#) [DD260N12K-A](#) [DD380N16A](#) [DD89N1600K-A](#) [APT2X21DC60J](#) [APT58M80J](#) [B522F-2-YEC](#) [MSTC90-16](#) [25.163.0653.1](#)
[25.163.2453.0](#) [25.163.4253.0](#) [25.190.2053.0](#) [25.194.3453.0](#) [25.320.4853.1](#) [25.320.5253.1](#) [25.326.3253.1](#) [25.326.3553.1](#) [25.330.1653.1](#)
[25.330.4753.1](#) [25.330.5253.1](#) [25.334.3253.1](#) [25.334.3353.1](#) [25.350.2053.0](#) [25.352.4753.1](#) [25.522.3253.0](#) [T483C](#) [T484C](#) [T485F](#) [T485H](#)
[T512F-YEB](#) [T513F](#) [T514F](#) [T554](#) [T612FSE](#) [25.161.3453.0](#) [25.179.2253.0](#) [25.194.3253.0](#) [25.325.1253.1](#) [25.326.4253.1](#) [25.330.0953.1](#)
[25.332.4353.1](#) [25.350.1653.0](#) [25.350.2453.0](#) [25.352.1453.0](#) [25.352.1653.0](#) [25.352.2453.0](#) [25.352.5453.1](#) [25.522.3353.0](#) [25.602.4053.0](#)
[25.640.5053.0](#)