

X-Class HiPerFET™ Power MOSFET

IXFN90N85X

$V_{DSS} = 850V$
 $I_{D25} = 90A$
 $R_{DS(on)} \leq 41m\Omega$

N-Channel Enhancement Mode
 Avalanche Rated
 Fast Intrinsic Diode

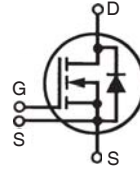

miniBLOC, SOT-227
 E153432

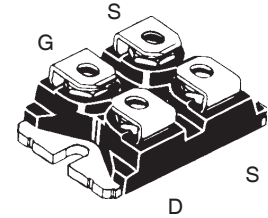

G = Gate
 S = Source
 D = Drain

Symbol	Test Conditions	Maximum Ratings	
V_{DSS}	$T_J = 25^\circ C$ to $150^\circ C$	850	V
V_{DGR}	$T_J = 25^\circ C$ to $150^\circ C$, $R_{GS} = 1M\Omega$	850	V
V_{GSS}	Continuous	± 30	V
V_{GSM}	Transient	± 40	V
I_{D25}	$T_C = 25^\circ C$	90	A
I_{DM}	$T_C = 25^\circ C$, Pulse Width Limited by T_{JM}	180	A
I_A	$T_C = 25^\circ C$	45	A
E_{AS}	$T_C = 25^\circ C$	4	J
P_D	$T_C = 25^\circ C$	1200	W
dv/dt	$I_S \leq I_{DM}$, $V_{DD} \leq V_{DSS}$, $T_J \leq 150^\circ C$	50	V/ns
T_J		-55 ... +150	$^\circ C$
T_{JM}		150	$^\circ C$
T_{stg}		-55 ... +150	$^\circ C$
V_{ISOL}	50/60 Hz, RMS $t = 1$ minute	2500	V~
	$I_{ISOL} \leq 1mA$ $t = 1$ second	3000	V~
M_d	Mounting Torque	1.5/13	Nm/lb.in
	Terminal Connection Torque	1.3/11.5	Nm/lb.in
Weight		30	g

Features

- International Standard Package
- miniBLOC, with Aluminium Nitride Isolation
- Isolation Voltage 2500V~
- High Current Handling Capability
- Fast Intrinsic Diode
- Avalanche Rated
- Low $R_{DS(on)}$

Advantages

- High Power Density
- Easy to Mount
- Space Savings

Applications

- Switch-Mode and Resonant-Mode Power Supplies
- DC-DC Converters
- PFC Circuits
- AC and DC Motor Drives
- Robotics and Servo Controls

Symbol	Test Conditions ($T_J = 25^\circ C$ Unless Otherwise Specified)	Characteristic Values		
		Min.	Typ.	Max.
BV_{DSS}	$V_{GS} = 0V$, $I_D = 3mA$	850		V
$V_{GS(th)}$	$V_{DS} = V_{GS}$, $I_D = 8mA$	3.5		5.5 V
I_{GSS}	$V_{GS} = \pm 30V$, $V_{DS} = 0V$			± 200 nA
I_{DSS}	$V_{DS} = V_{DSS}$, $V_{GS} = 0V$ $T_J = 125^\circ C$			50 μA 5 mA
$R_{DS(on)}$	$V_{GS} = 10V$, $I_D = 45A$, Note 1			41 m Ω

Symbol	Test Conditions ($T_J = 25^\circ\text{C}$, Unless Otherwise Specified)	Characteristic Values		
		Min.	Typ.	Max
g_{fs}	$V_{DS} = 10\text{V}$, $I_D = 45\text{A}$, Note 1	37	62	S
R_{Gi}	Gate Input Resistance		0.60	Ω
C_{iss}	} $V_{GS} = 0\text{V}$, $V_{DS} = 25\text{V}$, $f = 1\text{MHz}$		13.3	nF
C_{oss}			13.0	nF
C_{rss}			220	pF
Effective Output Capacitance				
$C_{o(er)}$	Energy related	} $V_{GS} = 0\text{V}$ $V_{DS} = 0.8 \cdot V_{DSS}$	395	pF
$C_{o(tr)}$	Time related		1820	pF
$t_{d(on)}$	} Resistive Switching Times $V_{GS} = 10\text{V}$, $V_{DS} = 0.5 \cdot V_{DSS}$, $I_D = 45\text{A}$ $R_G = 1\Omega$ (External)		50	ns
t_r			20	ns
$t_{d(off)}$			126	ns
t_f			8	ns
$Q_{g(on)}$	} $V_{GS} = 10\text{V}$, $V_{DS} = 0.5 \cdot V_{DSS}$, $I_D = 45\text{A}$		340	nC
Q_{gs}			78	nC
Q_{gd}			190	nC
R_{thJC}				0.104 $^\circ\text{C/W}$
R_{thCS}		0.05		$^\circ\text{C/W}$

Source-Drain Diode

Symbol	Test Conditions ($T_J = 25^\circ\text{C}$, Unless Otherwise Specified)	Characteristic Values		
		Min.	Typ.	Max.
I_S	$V_{GS} = 0\text{V}$			90 A
I_{SM}	Repetitive, Pulse Width Limited by T_{JM}			360 A
V_{SD}	$I_F = I_S$, $V_{GS} = 0\text{V}$, Note 1			1.4 V
t_{rr}	} $I_F = 45\text{A}$, $-di/dt = 200\text{A}/\mu\text{s}$ $V_R = 100\text{V}$, $V_{GS} = 0\text{V}$		250	ns
Q_{RM}			5.3	μC
I_{RM}			42.0	A

Note 1. Pulse test, $t \leq 300\mu\text{s}$, duty cycle, $d \leq 2\%$.

IXYS Reserves the Right to Change Limits, Test Conditions, and Dimensions.

IXYS MOSFETs and IGBTs are covered by one or more of the following U.S. patents:

4,835,592	4,931,844	5,049,961	5,237,481	6,162,665	6,404,065 B1	6,683,344	6,727,585	7,005,734 B2	7,157,338B2
4,860,072	5,017,508	5,063,307	5,381,025	6,259,123 B1	6,534,343	6,710,405 B2	6,759,692	7,063,975 B2	
4,881,106	5,034,796	5,187,117	5,486,715	6,306,728 B1	6,583,505	6,710,463	6,771,478 B2	7,071,537	

Fig. 1. Output Characteristics @ $T_J = 25^\circ\text{C}$

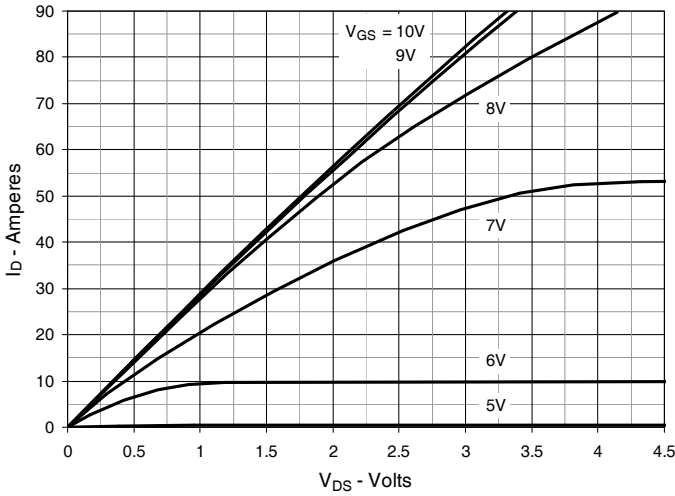

Fig. 2. Extended Output Characteristics @ $T_J = 25^\circ\text{C}$

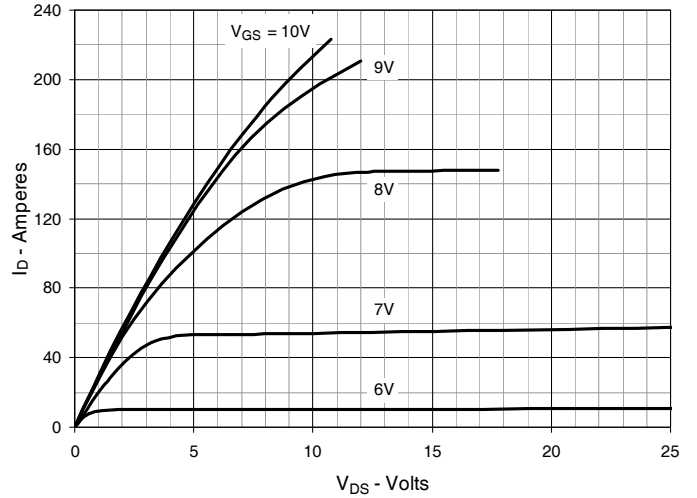

Fig. 3. Output Characteristics @ $T_J = 125^\circ\text{C}$

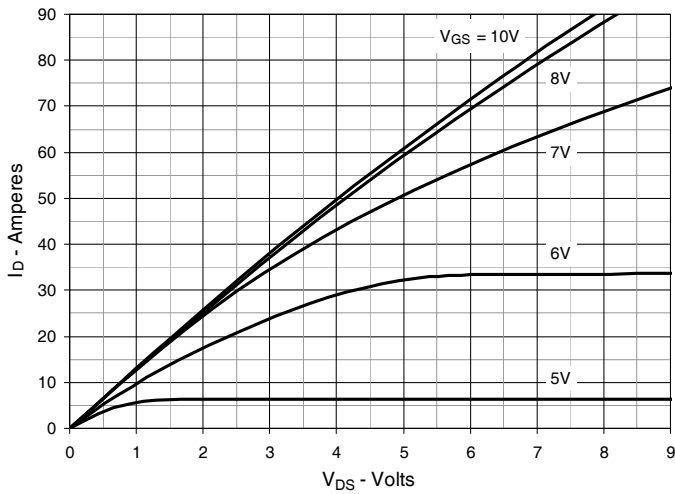

Fig. 4. $R_{DS(on)}$ Normalized to $I_D = 45A$ Value vs. Junction Temperature

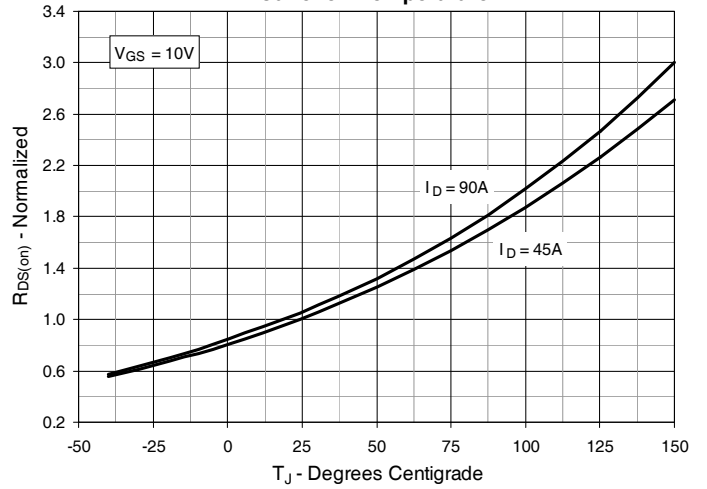

Fig. 5. $R_{DS(on)}$ Normalized to $I_D = 45A$ Value vs. Drain Current

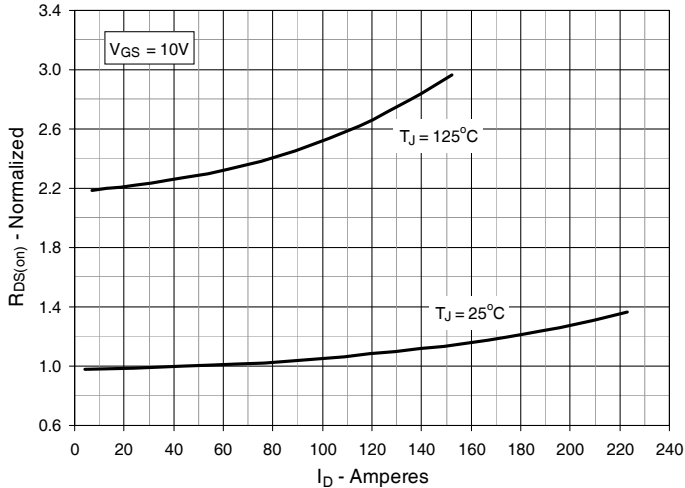

Fig. 6. Normalized Breakdown & Threshold Voltages vs. Junction Temperature

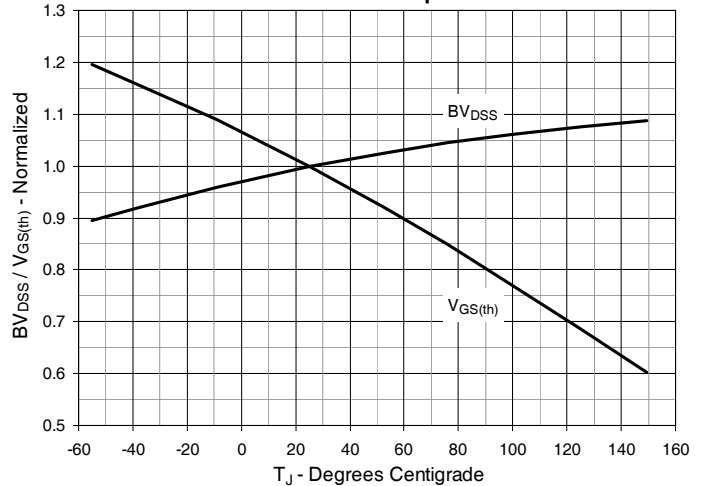

Fig. 7. Maximum Drain Current vs. Case Temperature

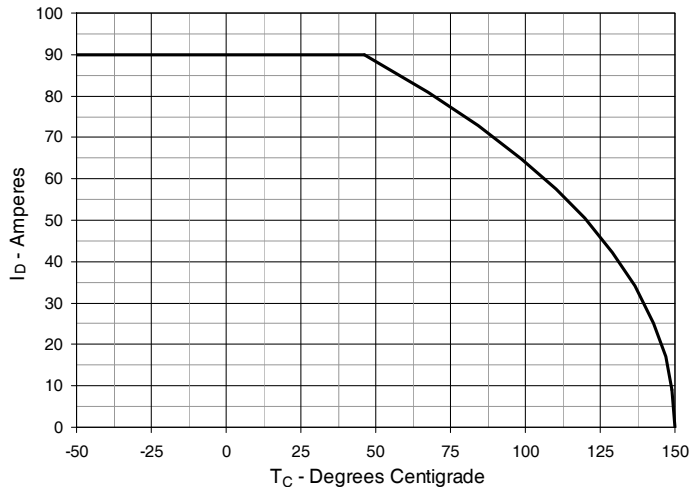

Fig. 8. Input Admittance

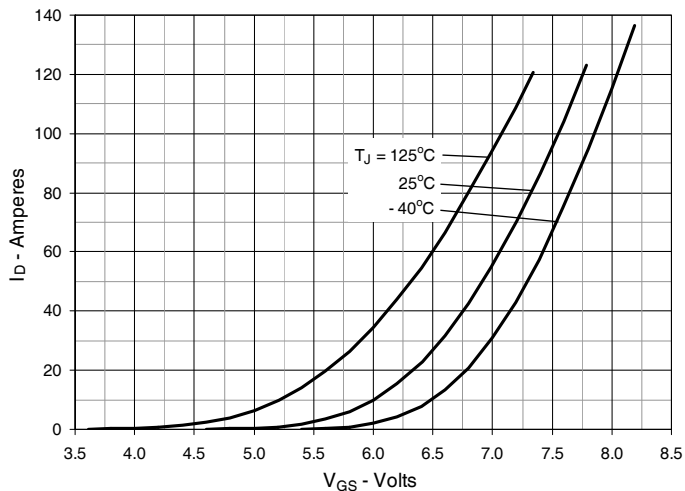

Fig. 9. Transconductance

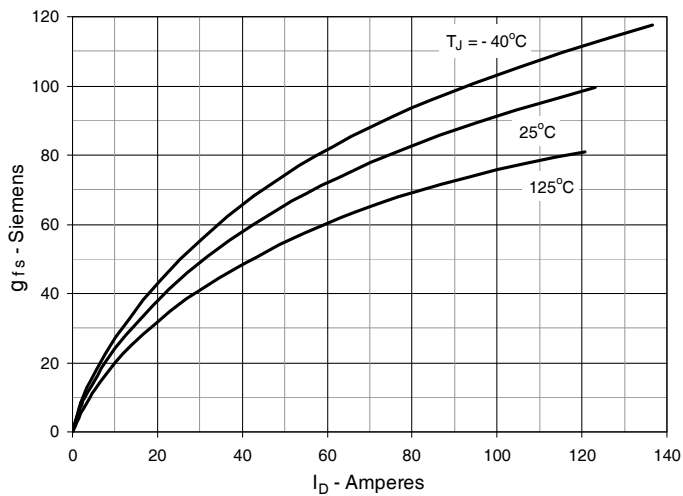

Fig. 10. Forward Voltage Drop of Intrinsic Diode

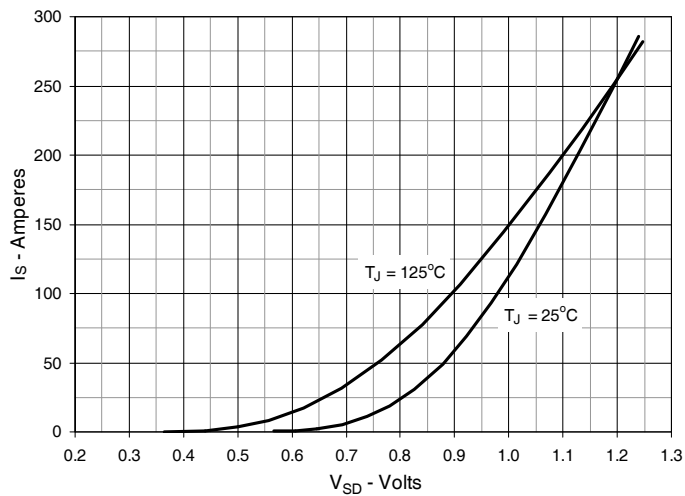

Fig. 11. Gate Charge

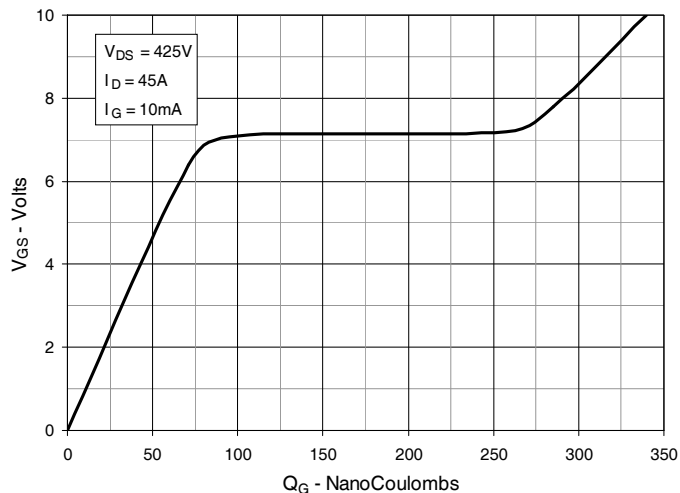

Fig. 12. Capacitance

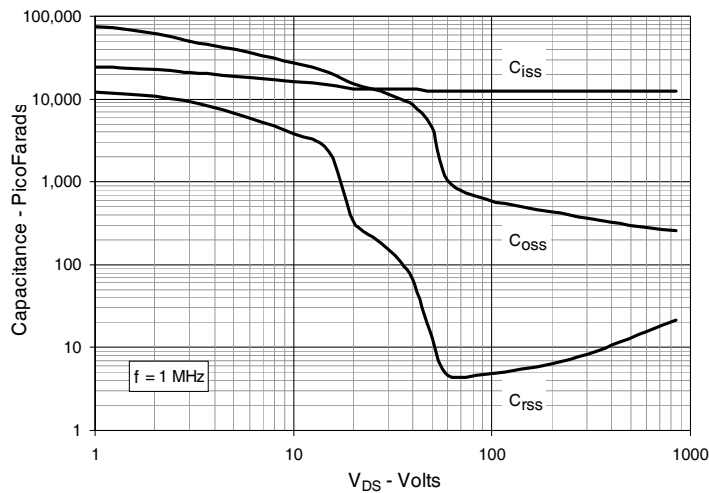

Fig. 13. Output Capacitance Stored Energy

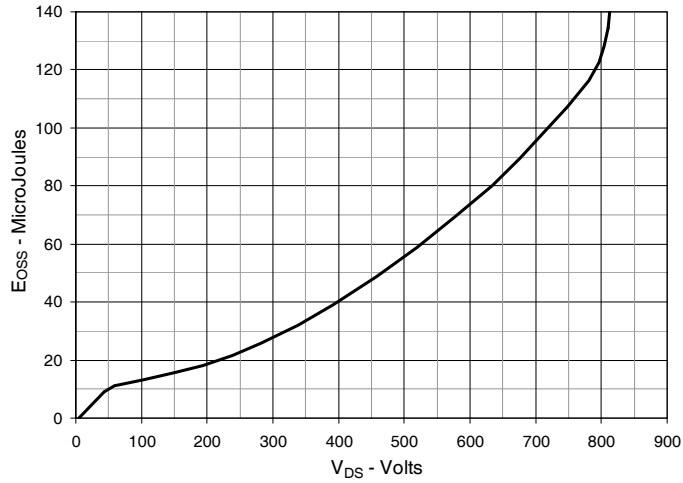

Fig. 14. Forward-Bias Safe Operating Area

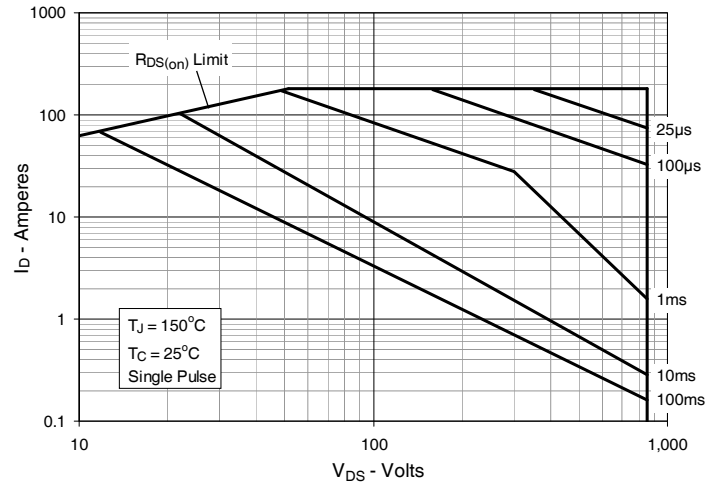
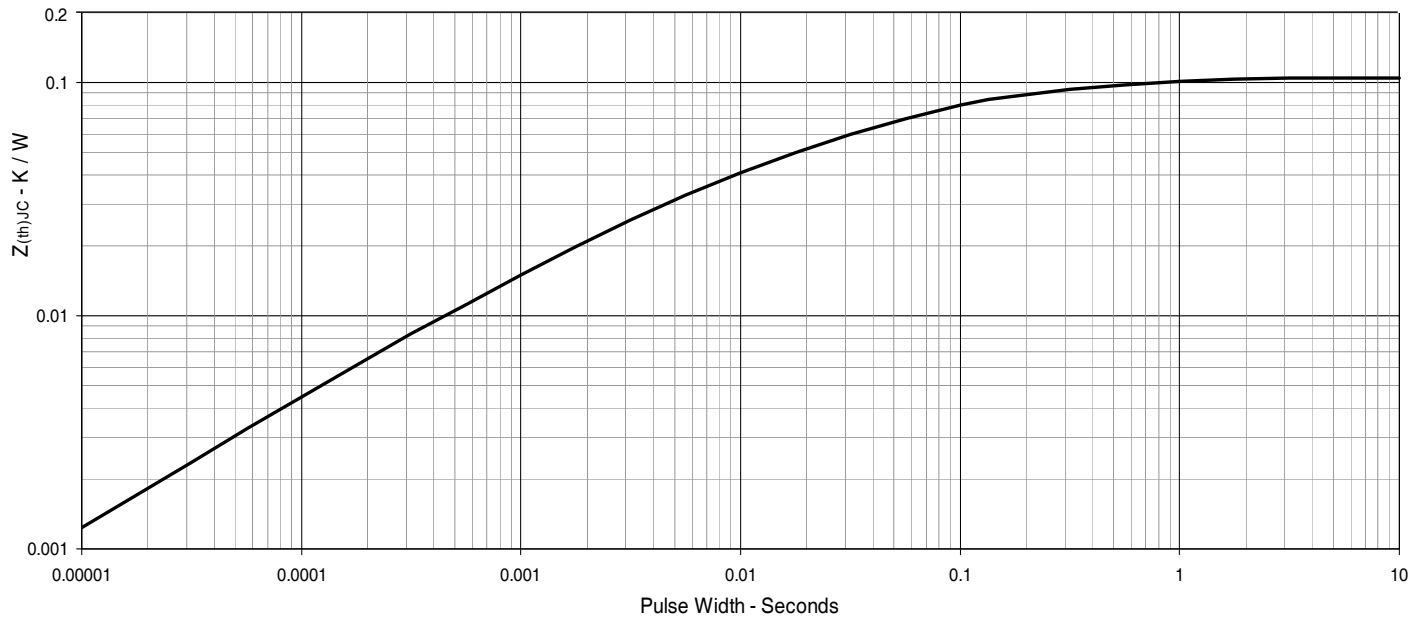
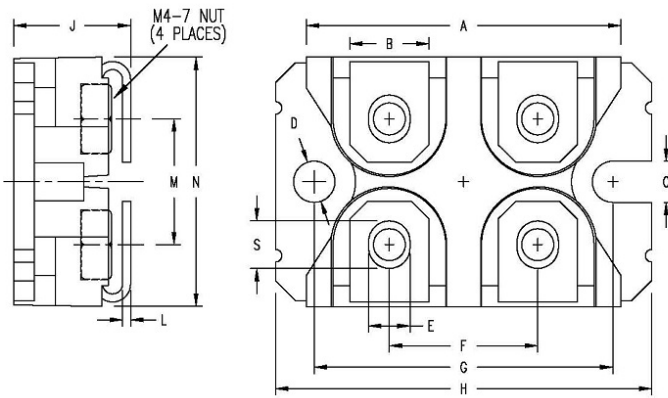

Fig. 15. Maximum Transient Thermal Impedance



SOT-227 Outline

SYM	INCHES		MILLIMETERS	
	MIN	MAX	MIN	MAX
A	1.224	1.260	31.10	32.00
B	.303	.327	7.70	8.30
C	.161	.173	4.10	4.40
D	.161	.173	4.10	4.40
E	.161	.173	4.10	4.40
F	.587	.598	14.90	15.20
G	1.181	1.201	30.00	30.50
H	1.488	1.508	37.80	38.30
J	.461	.484	11.70	12.30
L	.030	.033	0.75	0.85
M	.492	.512	12.50	13.00
N	.984	1.004	25.00	25.50
O	.075	.087	1.90	2.20
S	.181	.193	4.60	4.90
U	.000	.005	0.00	0.13

- NUT MATERIAL:
 STANDARD - Low carbon steel with Ni plating.
 OPTIONAL: - Brass Nut is available.
 PART NUMBER-BN
- ALL METAL SURFACE ARE PRE NI PLATED EXCEPT TRIM AREA.

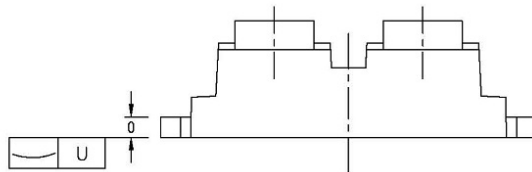



Disclaimer Notice - Information furnished is believed to be accurate and reliable. However, users should independently evaluate the suitability of and test each product selected for their own applications. Littelfuse products are not designed for, and may not be used in, all applications. Read complete Disclaimer Notice at www.littelfuse.com/disclaimer-electronics.

X-ON Electronics

Largest Supplier of Electrical and Electronic Components

Click to view similar products for [Discrete Semiconductor Modules](#) category:

Click to view products by [IXYS](#) manufacturer:

Other Similar products are found below :

[M252511FV](#) [DD260N12K-A](#) [DD380N16A](#) [DD89N1600K-A](#) [APT2X21DC60J](#) [APT58M80J](#) [B522F-2-YEC](#) [MSTC90-16](#) [25.163.0653.1](#)
[25.163.2453.0](#) [25.163.4253.0](#) [25.190.2053.0](#) [25.194.3453.0](#) [25.320.4853.1](#) [25.320.5253.1](#) [25.326.3253.1](#) [25.326.3553.1](#) [25.330.1653.1](#)
[25.330.4753.1](#) [25.330.5253.1](#) [25.334.3253.1](#) [25.334.3353.1](#) [25.350.2053.0](#) [25.352.4753.1](#) [25.522.3253.0](#) [T483C](#) [T484C](#) [T485F](#) [T485H](#)
[T512F-YEB](#) [T513F](#) [T514F](#) [T554](#) [T612FSE](#) [25.161.3453.0](#) [25.179.2253.0](#) [25.194.3253.0](#) [25.325.1253.1](#) [25.326.4253.1](#) [25.330.0953.1](#)
[25.332.4353.1](#) [25.350.1653.0](#) [25.350.2453.0](#) [25.352.1453.0](#) [25.352.1653.0](#) [25.352.2453.0](#) [25.352.5453.1](#) [25.522.3353.0](#) [25.602.4053.0](#)
[25.640.5053.0](#)