

# High Voltage IGBTs

## IXGT4N250C IXGH4N250C

$$V_{CES} = 2500V$$

$$I_{C110} = 4A$$

$$V_{CE(sat)} \leq 6.0V$$

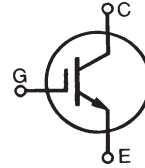

Symbol	Test Conditions	Maximum Ratings	
$V_{CES}$	$T_C = 25^\circ C$ to $150^\circ C$	2500	V
$V_{GGR}$	$T_J = 25^\circ C$ to $150^\circ C$ , $R_{GE} = 1M\Omega$	2500	V
$V_{GES}$	Continuous	$\pm 20$	V
$V_{GEM}$	Transient	$\pm 30$	V
$I_{C25}$	$T_C = 25^\circ C$	13	A
$I_{C110}$	$T_C = 110^\circ C$	4	A
$I_{CM}$	$T_C = 25^\circ C$ , 1ms	46	A
<b>SSOA (RBSOA)</b>	$V_{GE} = 15V$ , $T_{VJ} = 125^\circ C$ , $R_G = 20\Omega$ Clamped Inductive Load	$I_{CM} = 8$ $V_{CES} \leq 2000$	A V
$P_C$	$T_C = 25^\circ C$	150	W
$T_J$		-55 ... +150	$^\circ C$
$T_{JM}$		150	$^\circ C$
$T_{stg}$		-55 ... +150	$^\circ C$
$T_L$	1.6mm (0.062 in.) from Case for 10s	300	$^\circ C$
$T_{SOLD}$	Plastic Body for 10 seconds	260	$^\circ C$
$M_d$	Mounting Torque (TO-247)	1.13/10	Nm/lb.in.
<b>Weight</b>	TO-268	4	g
	TO-247	6	g

TO-268 (IXGT)

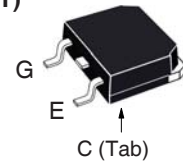

TO-247 (IXGH)

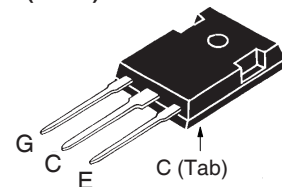

G = Gate      C = Collector  
E = Emitter    Tab = Collector

### Features

- Fast Turn off IGBTs
- International Standard Packages

### Advantages

- High Power Density
- Low Gate Drive Requirement

### Applications

- Buck Converters
- Switch-Mode and Resonant-Mode Power Supplies
- Uninterruptible Power Supplies

Symbol	Test Conditions ( $T_J = 25^\circ C$ Unless Otherwise Specified)	Characteristic Values		
		Min.	Typ.	Max.
$BV_{CES}$	$I_C = 250\mu A$ , $V_{GE} = 0V$	2500		V
$V_{GE(th)}$	$I_C = 250\mu A$ , $V_{CE} = V_{GE}$	3.0		V
$I_{CES}$	$V_{CE} = 0.8 \cdot V_{CES}$ , $V_{GE} = 0V$ $T_J = 125^\circ C$			25 $\mu A$ 1 mA
$I_{GES}$	$V_{CE} = 0V$ , $V_{GE} = \pm 20V$			$\pm 100$ nA
$V_{CE(sat)}$	$I_C = 4A$ , $V_{GE} = 15V$ , Note 1 $T_J = 125^\circ C$		4.6 4.5	6.0 V V

### Symbol Test Conditions

( $T_J = 25^\circ\text{C}$  Unless Otherwise Specified)

### Characteristic Values

		Min.	Typ.	Max.	
$g_{fS}$	$I_C = 4A, V_{CE} = 10V$ , Note 1	4.0	6.0		S
$C_{ies}$	$V_{CE} = 25V, V_{GE} = 0V, f = 1MHz$		1150		pF
$C_{oes}$			52		pF
$C_{res}$			19		pF
$Q_{g(on)}$	$I_C = 4A, V_{GE} = 15V, V_{CE} = 1000V$		57		nC
$Q_{ge}$			8		nC
$Q_{gc}$			21		nC
$t_{d(off)}$	<b>Inductive Load, <math>T_J = 25^\circ\text{C}</math></b> $I_C = 4A, V_{GE} = 15V$ $V_{CE} = 0.5 \cdot V_{CES}, R_G = 20\Omega$ Note 2		350		ns
$t_{fi}$			29		ns
$E_{(off)}$			0.36		mJ
$t_{d(off)}$	<b>Inductive Load, <math>T_J = 125^\circ\text{C}</math></b> $I_C = 4A, V_{GE} = 15V$ $V_{CE} = 0.5 \cdot V_{CES}, R_G = 20\Omega$ Note 2		385		ns
$t_{fi}$			86		ns
$E_{(off)}$			0.80		mJ
$R_{thJC}$				0.82	$^\circ\text{C/W}$
$R_{thCS}$	TO-247		0.21		$^\circ\text{C/W}$

### Notes:

1. Pulse test,  $t \leq 300\mu\text{s}$ , duty cycle,  $d \leq 2\%$ .
2. Switching times & energy losses may increase for higher  $V_{CE}$  (Clamp),  $T_J$  or  $R_G$ .

Additional provisions for lead to lead voltage isolation are required at  $V_{CE} > 1200V$ .

### ADVANCE TECHNICAL INFORMATION

The product presented herein is under development. The Technical Specifications offered are derived from a subjective evaluation of the design, based upon prior knowledge and experience, and constitute a "considered reflection" of the anticipated result. IXYS reserves the right to change limits, test conditions, and dimensions without notice.

### TO-268 Outline

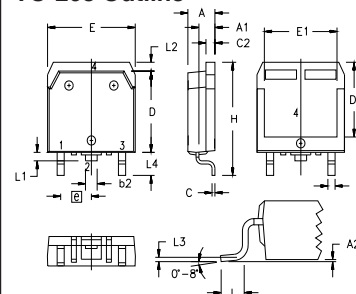

Terminals: 1 - Gate  
2,4 - Collector  
3 - Emitter

SYM	INCHES		MILLIMETERS	
	MIN	MAX	MIN	MAX
A	.193	.201	4.90	5.10
A1	.106	.114	2.70	2.90
A2	.001	.010	0.02	0.25
b	.045	.057	1.15	1.45
b2	.075	.083	1.90	2.10
C	.016	.026	0.40	0.65
C2	.057	.063	1.45	1.60
D	.543	.551	13.80	14.00
D1	.488	.500	12.40	12.70
E	.624	.632	15.85	16.05
E1	.524	.535	13.30	13.60
e	.215 BSC		5.45 BSC	
H	.736	.752	18.70	19.10
L	.094	.106	2.40	2.70
L1	.047	.055	1.20	1.40
L2	.039	.045	1.00	1.15
L3	.010 BSC		0.25 BSC	
L4	.150	.161	3.80	4.10

### TO-247 Outline

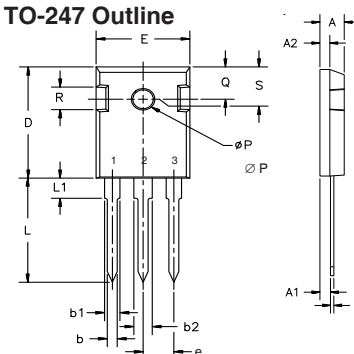

Terminals: 1 - Gate  
2 - Collector  
3 - Emitter

Dim.	Millimeter		Inches	
	Min.	Max.	Min.	Max.
A	4.7	5.3	.185	.209
A <sub>1</sub>	2.2	2.54	.087	.102
A <sub>2</sub>	2.2	2.6	.059	.098
b	1.0	1.4	.040	.055
b <sub>1</sub>	1.65	2.13	.065	.084
b <sub>2</sub>	2.87	3.12	.113	.123
C	.4	.8	.016	.031
D	20.80	21.46	.819	.845
E	15.75	16.26	.610	.640
e	5.20	5.72	0.205	0.225
L	19.81	20.32	.780	.800
L1		4.50		.177
ØP	3.55	3.65	.140	.144
Q	5.89	6.40	0.232	0.252
R	4.32	5.49	.170	.216
S	6.15 BSC		242 BSC	

IXYS Reserves the Right to Change Limits, Test Conditions and Dimensions.

IXYS MOSFETs and IGBTs are covered by one or more of the following U.S. patents:

4,835,592	4,931,844	5,049,961	5,237,481	6,162,665	6,404,065 B1	6,683,344	6,727,585	7,005,734 B2	7,157,338B2
4,850,072	5,017,508	5,063,307	5,381,025	6,259,123 B1	6,534,343	6,710,405 B2	6,759,692	7,063,975 B2	
4,881,106	5,034,796	5,187,117	5,486,715	6,306,728 B1	6,583,505	6,710,463	6,771,478 B2	7,071,537	

**Fig. 1. Output Characteristics @  $T_J = 25^\circ\text{C}$**

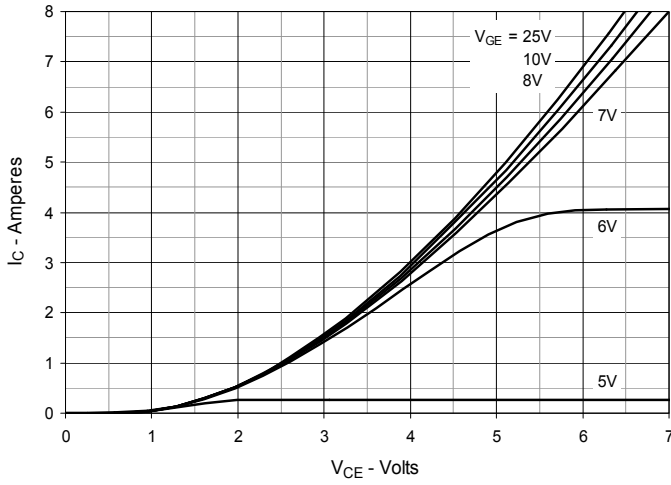

**Fig. 2. Extended Output Characteristics @  $T_J = 25^\circ\text{C}$**

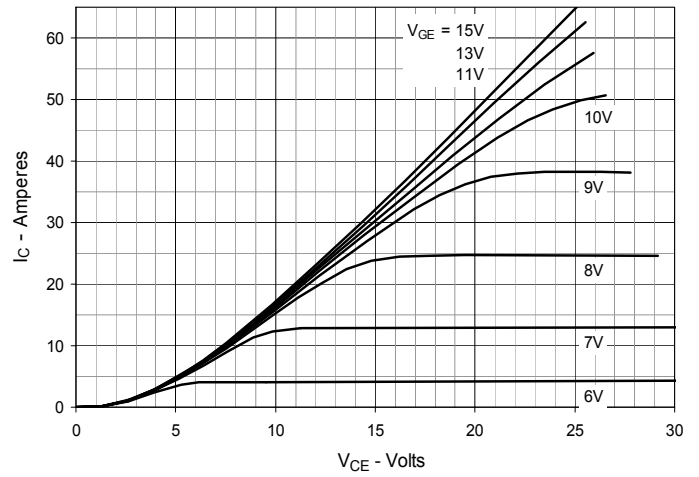

**Fig. 3. Output Characteristics @  $T_J = 125^\circ\text{C}$**

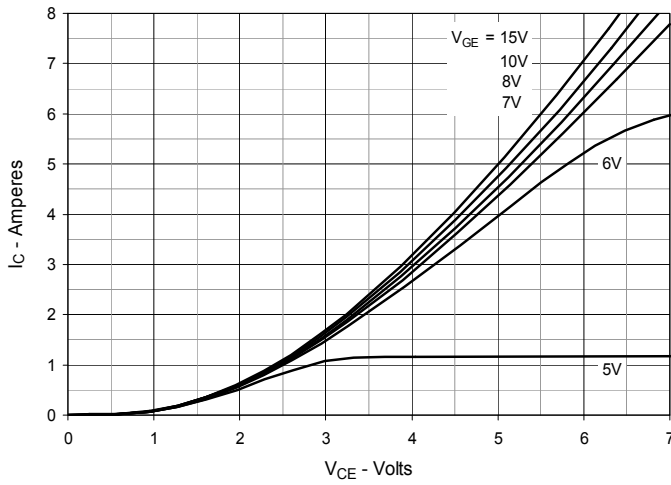

**Fig. 4. Dependence of  $V_{CE(sat)}$  on Junction Temperature**

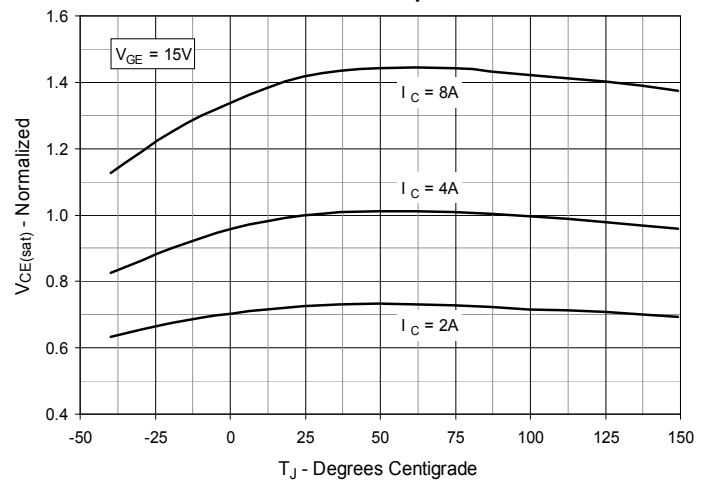

**Fig. 5. Collector-to-Emitter Voltage vs. Gate-to-Emitter Voltage**

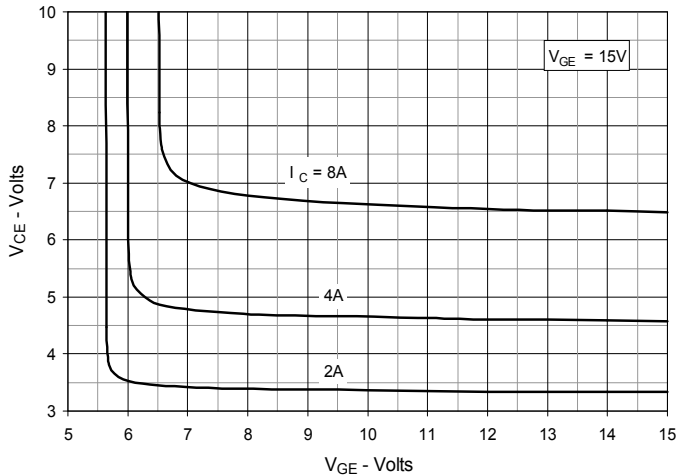

**Fig. 6. Input Admittance**

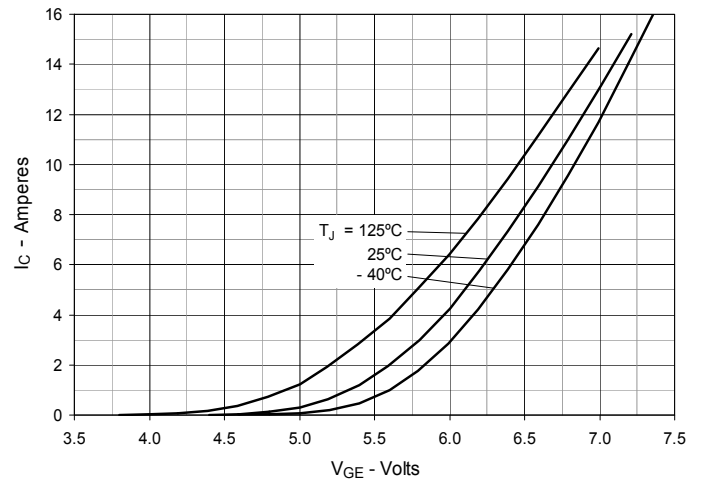

**Fig. 7. Transconductance**

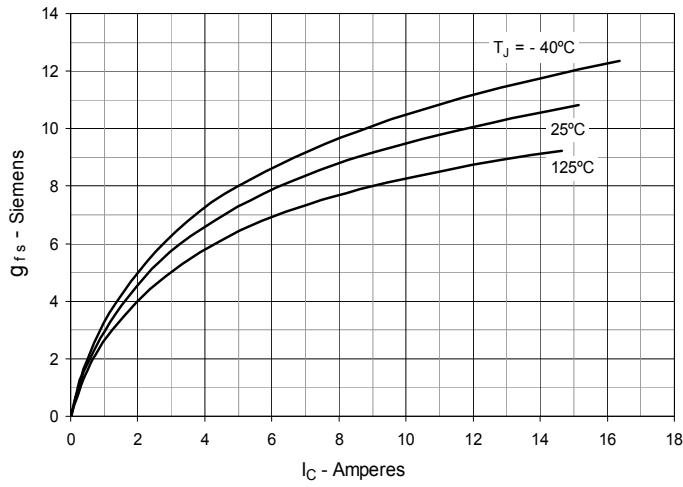

**Fig. 8. Gate Charge**

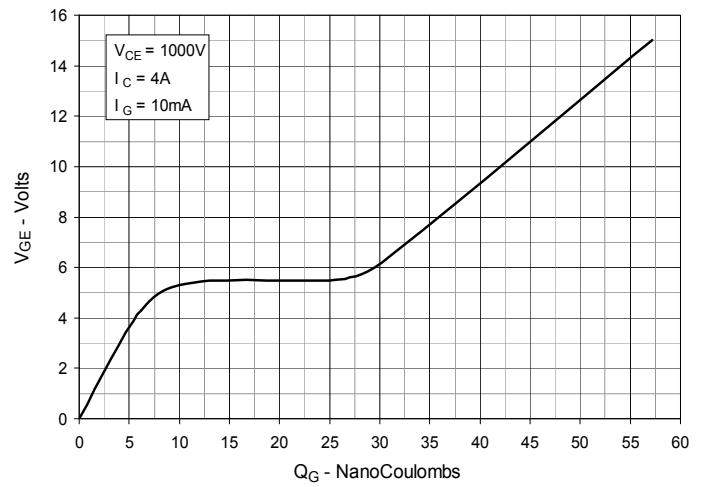

**Fig. 9. Reverse-Bias Safe Operating Area**

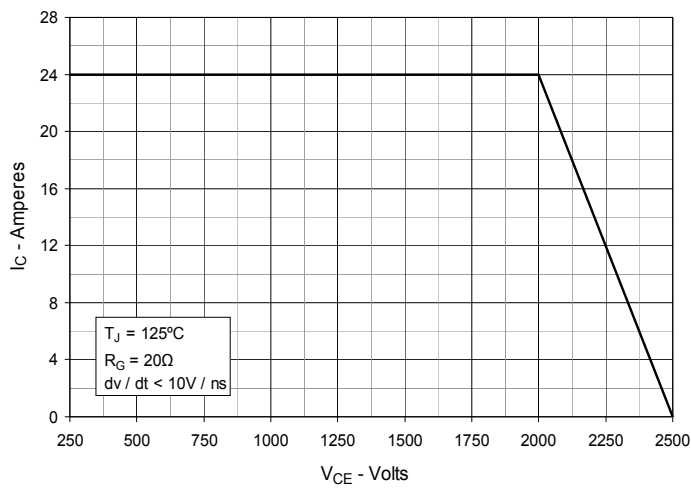

**Fig. 10. Capacitance**

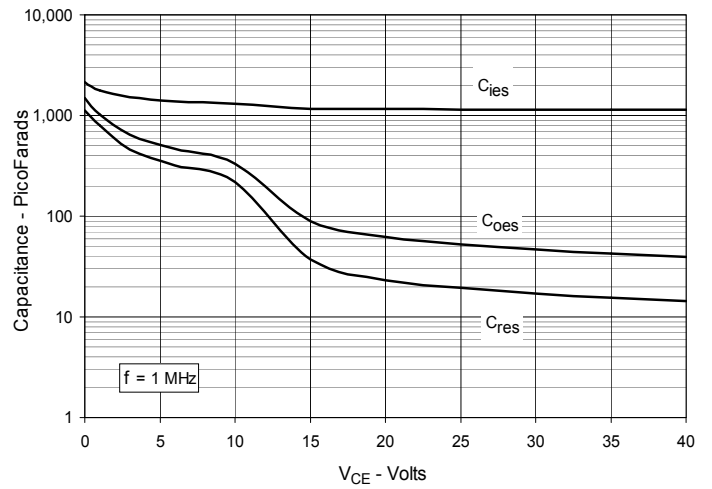

**Fig. 11. Maximum Transient Thermal Impedance**

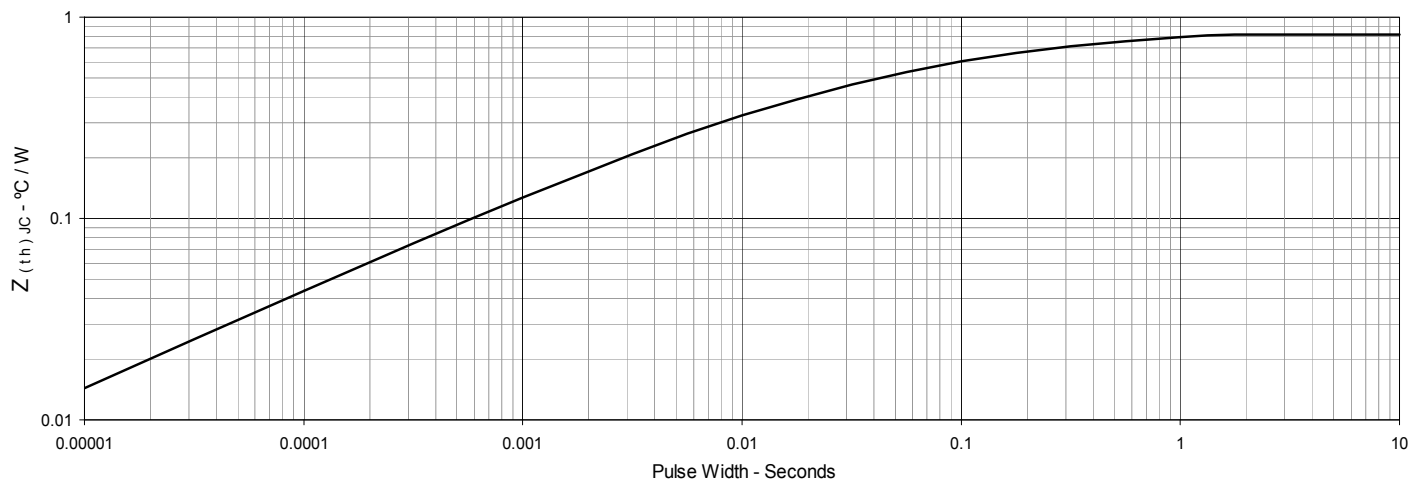

IXYS Reserves the Right to Change Limits, Test Conditions and Dimensions.

## X-ON Electronics

Largest Supplier of Electrical and Electronic Components

*Click to view similar products for [IGBT Modules category](#):*

*Click to view products by [IXYS manufacturer](#):*

Other Similar products are found below :

[F3L100R07W2E3\\_B11](#) [F3L15R12W2H3\\_B27](#) [F3L400R07ME4\\_B22](#) [F3L400R12PT4\\_B26](#) [F4-100R12KS4](#) [F4-50R07W2H3\\_B51](#) [F4-75R12KS4\\_B11](#) [FB15R06W1E3](#) [FB20R06W1E3\\_B11](#) [FD1000R33HE3-K](#) [FD300R06KE3](#) [FD300R12KE3](#) [FD300R12KS4\\_B5](#) [FD400R12KE3](#) [FD400R33KF2C-K](#) [FD401R17KF6C\\_B2](#) [FD-DF80R12W1H3\\_B52](#) [FF100R12KS4](#) [FF1200R17KE3\\_B2](#) [FF150R12KE3G](#) [FF200R06KE3](#) [FF200R06YE3](#) [FF200R12KT3](#) [FF200R12KT3\\_E](#) [FF200R12KT4](#) [FF200R17KE3](#) [FF300R06KE3\\_B2](#) [FF300R12KE4\\_E](#) [FF300R12KS4HOSA1](#) [FF300R12ME4\\_B11](#) [FF300R12MS4](#) [FF300R17ME4](#) [FF450R12ME4P](#) [FF450R17IE4](#) [FF600R12IE4V](#) [FF600R12IP4V](#) [FF800R17KP4\\_B2](#) [FF900R12IE4V](#) [MIXA30W1200TED](#) [MIXA450PF1200TSF](#) [FP06R12W1T4\\_B3](#) [FP100R07N3E4](#) [FP100R07N3E4\\_B11](#) [FP10R06W1E3\\_B11](#) [FP10R12W1T4\\_B11](#) [FP10R12YT3](#) [FP10R12YT3\\_B4](#) [FP150R07N3E4](#) [FP15R12KT3](#) [FP15R12W2T4](#)