

$V_{CES} = 600V$

$I_{C110} = 72A$

$V_{CE(sat)} \leq 2.5V$

$t_{fi} (typ) = 55ns$

**High-Speed PT IGBT for
40-100kHz Switching**

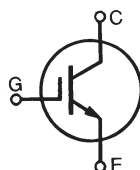

Symbol	Test Conditions	Maximum Ratings	
V_{CES}	$T_J = 25^\circ C$ to $150^\circ C$	600	V
V_{CGR}	$T_J = 25^\circ C$ to $150^\circ C$, $R_{GE} = 1M\Omega$	600	V
V_{GES}	Continuous	± 20	V
V_{GEM}	Transient	± 30	V
I_{C25}	$T_C = 25^\circ C$ (Limited by Leads)	75	A
I_{C110}	$T_C = 110^\circ C$ (Chip Capability)	72	A
I_{CM}	$T_C = 25^\circ C$, 1ms	360	A
I_A	$T_C = 25^\circ C$	50	A
E_{AS}	$T_C = 25^\circ C$	500	mJ
SSOA (RBSOA)	$V_{GE} = 15V$, $T_{VJ} = 125^\circ C$, $R_G = 2\Omega$ Clamped Inductive Load	$I_{CM} = 150$ $V_{CE} \leq V_{CES}$	A
P_C	$T_C = 25^\circ C$	540	W
T_J		-55 ... +150	$^\circ C$
T_{JM}		150	$^\circ C$
T_{stg}		-55 ... +150	$^\circ C$
T_L	Maximum Lead Temperature for Soldering	300	$^\circ C$
T_{SOLD}	1.6 mm (0.062in.) from Case for 10s	260	$^\circ C$
M_d	Mounting Torque	1.13/10	Nm/lb.in.
Weight		6	g

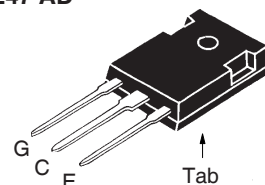
TO-247 AD

G = Gate C = Collector
E = Emitter Tab = Collector

Features

- Optimized for Low Switching Losses
- Square RBSOA
- Avalanche Rated
- International Standard Package

Advantages

- High Power Density
- Low Gate Drive Requirement

Applications

- High Frequency Power Inverters
- UPS
- Motor Drives
- SMPS
- PFC Circuits
- Battery Chargers
- Welding Machines
- Lamp Ballasts

Symbol	Test Conditions ($T_J = 25^\circ C$, Unless Otherwise Specified)	Characteristic Values		
		Min.	Typ.	Max.
BV_{CES}	$I_C = 250\mu A$, $V_{GE} = 0V$	600		V
$V_{GE(th)}$	$I_C = 250\mu A$, $V_{CE} = V_{GE}$	3.0		V
I_{CES}	$V_{CE} = V_{CES}$, $V_{GE} = 0V$ $T_J = 125^\circ C$			50 μA 1 mA
I_{GES}	$V_{CE} = 0V$, $V_{GE} = \pm 20V$			± 100 nA
$V_{CE(sat)}$	$I_C = 50A$, $V_{GE} = 15V$ $T_J = 125^\circ C$		2.10 1.65	2.50 V V

Symbol	Test Conditions ($T_J = 25^\circ\text{C}$, Unless Otherwise Specified)	Characteristic Values		
		Min.	Typ.	Max.
g_{fs}	$I_C = 50\text{A}, V_{CE} = 10\text{V}$, Note 1	33	55	S
C_{ies}	$V_{CE} = 25\text{V}, V_{GE} = 0\text{V}, f = 1\text{MHz}$		4780	pF
C_{oes}			330	pF
C_{res}			117	pF
Q_g	$I_C = 50\text{A}, V_{GE} = 15\text{V}, V_{CE} = 0.5 \cdot V_{CES}$		174	nC
Q_{ge}			33	nC
Q_{gc}			72	nC
$t_{d(on)}$	Inductive Load, $T_J = 25^\circ\text{C}$ $I_C = 50\text{A}, V_{GE} = 15\text{V}$		27	ns
t_{ri}			37	ns
E_{on}			1.03	mJ
$t_{d(off)}$	$V_{CE} = 480\text{V}, R_G = 2\Omega$, Note 2		77	130 ns
t_{fi}			55	110 ns
E_{off}			0.48	0.95 mJ
$t_{d(on)}$	Inductive Load, $T_J = 125^\circ\text{C}$ $I_C = 50\text{A}, V_{GE} = 15\text{V}$		26	ns
t_{ri}			36	ns
E_{on}			1.48	mJ
$t_{d(off)}$	$V_{CE} = 480\text{V}, R_G = 2\Omega$, Note 2		120	ns
t_{fi}			124	ns
E_{off}			0.93	mJ
R_{thJC}			0.23	$^\circ\text{C/W}$
R_{thCK}		0.21		$^\circ\text{C/W}$

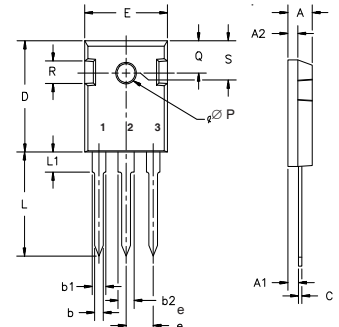
TO-247 (IXGH) Outline

 Terminals: 1 - Gate 2 - Collector
 3 - Emitter Tab - Collector

Dim.	Millimeter		Inches	
	Min.	Max.	Min.	Max.
A	4.7	5.3	.185	.209
A ₁	2.2	2.54	.087	.102
A ₂	2.2	2.6	.059	.098
b	1.0	1.4	.040	.055
b ₁	1.65	2.13	.065	.084
b ₂	2.87	3.12	.113	.123
C	.4	.8	.016	.031
D	20.80	21.46	.819	.845
E	15.75	16.26	.610	.640
e	5.20	5.72	0.205	0.225
L	19.81	20.32	.780	.800
L1		4.50		.177
∅P	3.55	3.65	.140	.144
Q	5.89	6.40	0.232	0.252
R	4.32	5.49	.170	.216
S	6.15	BSC	242	BSC

Notes:

1. Pulse test, $t \leq 300\mu\text{s}$, duty cycle, $d \leq 2\%$.
2. Switching times & energy losses may increase for higher V_{CE} (Clamp), T_J or R_G .

IXYS Reserves the Right to Change Limits, Test Conditions, and Dimensions.

IXYS MOSFETs and IGBTs are covered by one or more of the following U.S. patents:	4,835,592	4,931,844	5,049,961	5,237,481	6,162,665	6,404,065 B1	6,683,344	6,727,585	7,005,734 B2	7,157,338B2
	4,850,072	5,017,508	5,063,307	5,381,025	6,259,123 B1	6,534,343	6,710,405 B2	6,759,692	7,063,975 B2	
	4,881,106	5,034,796	5,187,117	5,486,715	6,306,728 B1	6,583,505	6,710,463	6,771,478 B2	7,071,537	

Fig. 1. Output Characteristics @ $T_J = 25^\circ\text{C}$

Fig. 2. Extended Output Characteristics @ $T_J = 25^\circ\text{C}$

Fig. 3. Output Characteristics @ $T_J = 125^\circ\text{C}$

Fig. 4. Dependence of $V_{CE(sat)}$ on Junction Temperature

Fig. 5. Collector-to-Emitter Voltage vs. Gate-to-Emitter Voltage

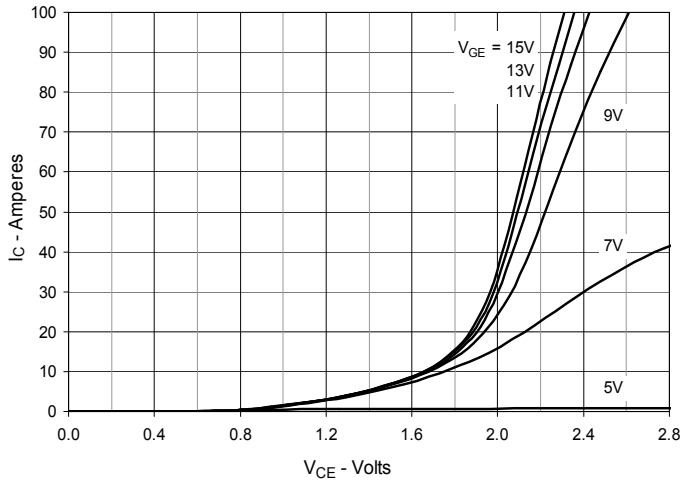
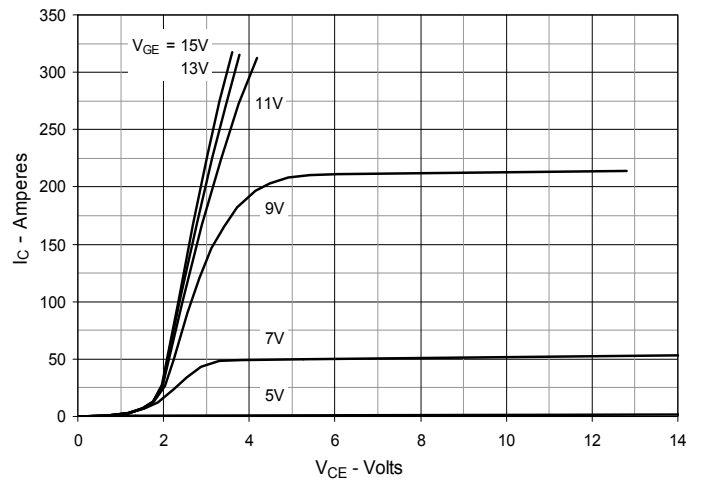
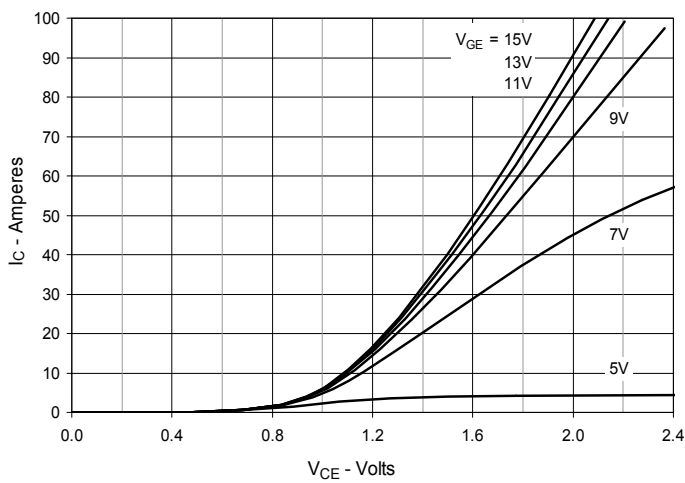
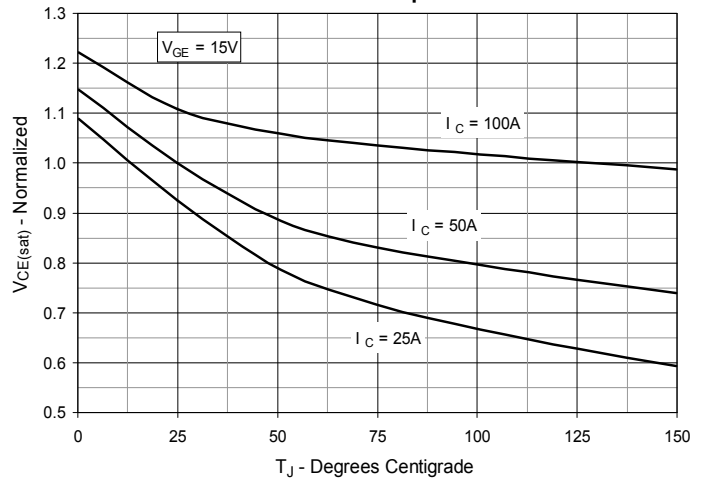
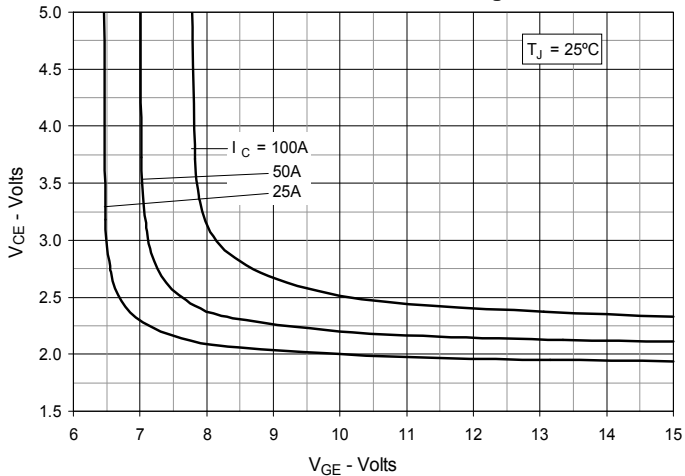
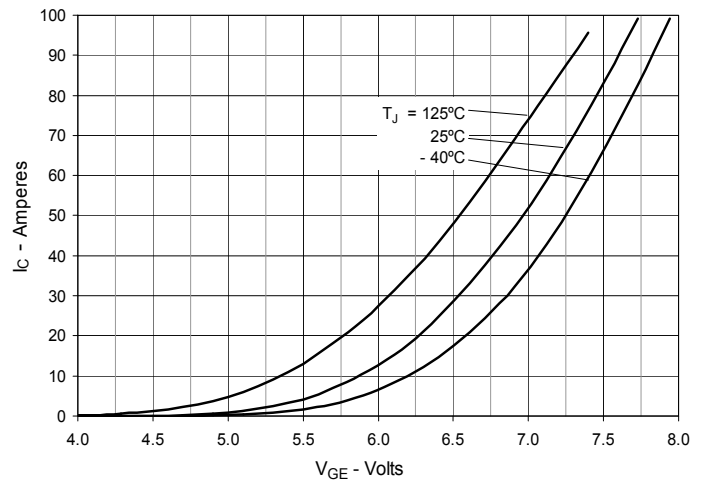
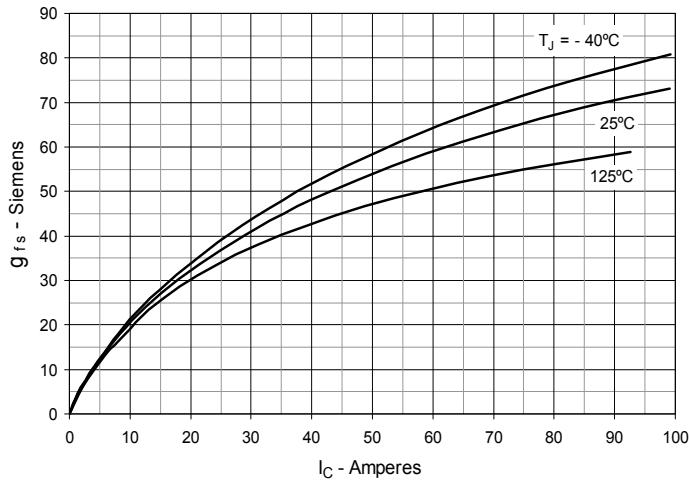
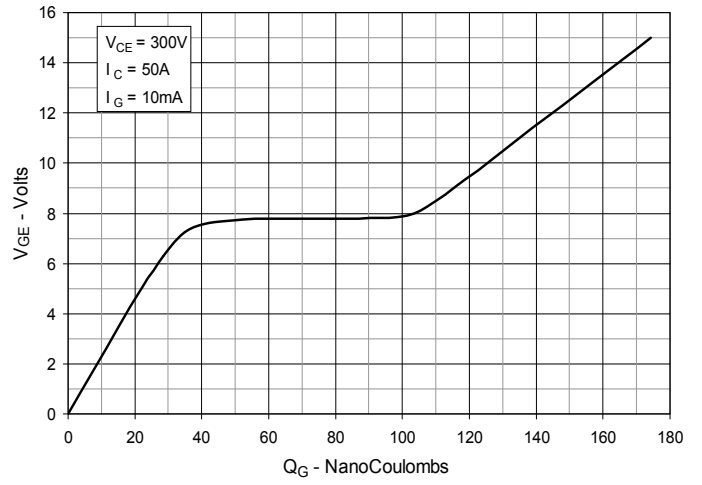
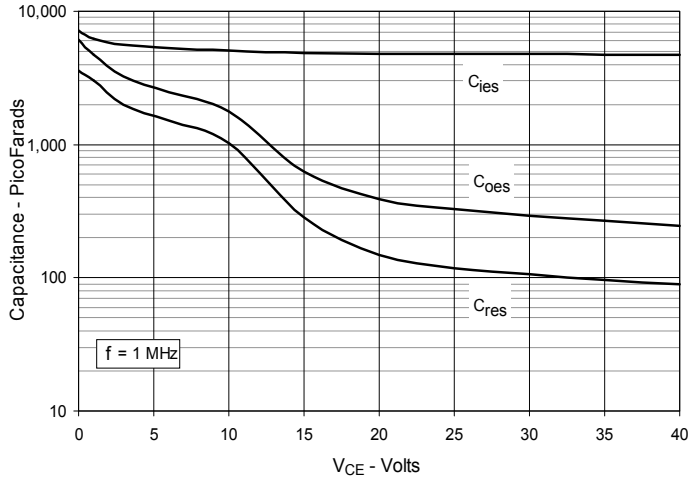
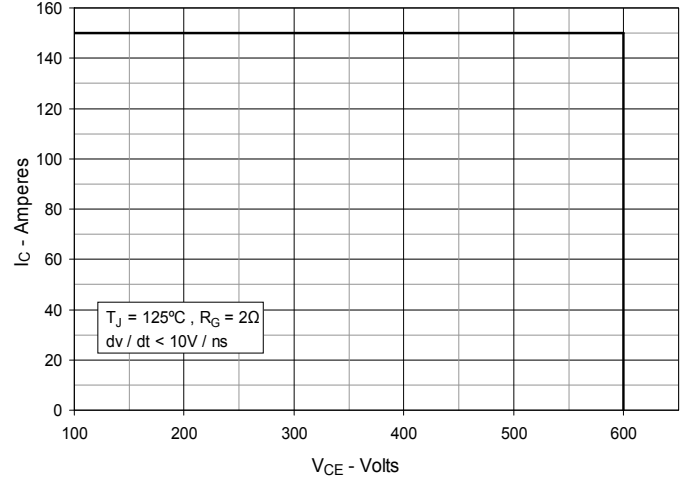
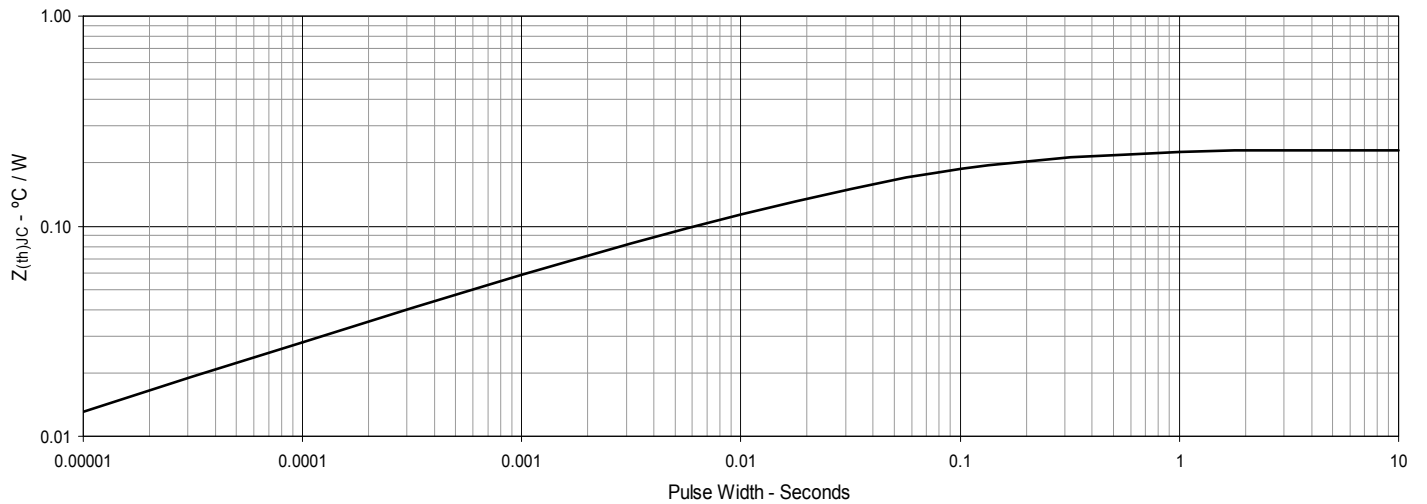
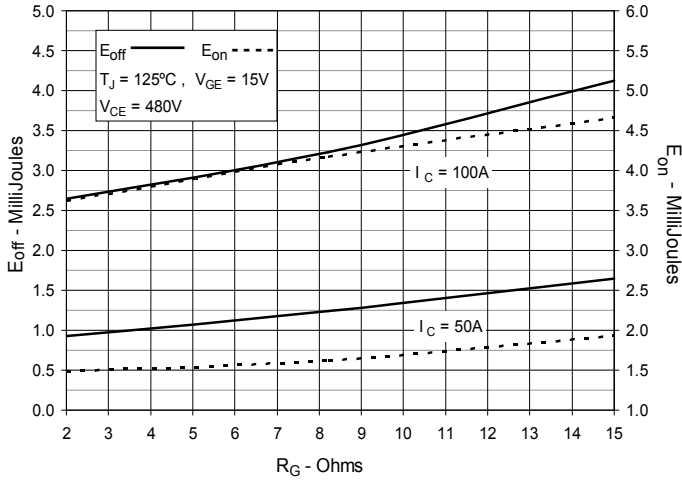
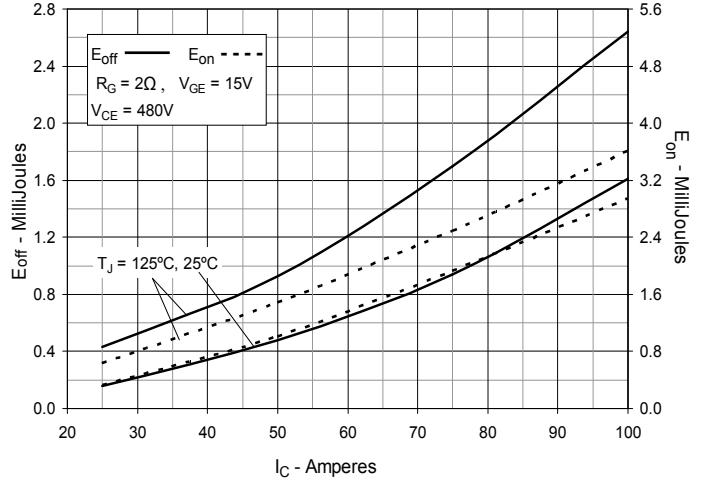
Fig. 6. Input Admittance

Fig. 7. Transconductance

Fig. 8. Gate Charge

Fig. 9. Capacitance

Fig. 10. Reverse-Bias Safe Operating Area

Fig. 11. Maximum Transient Thermal Impedance

**Fig. 12. Inductive Switching
Energy Loss vs. Gate Resistance**



**Fig. 13. Inductive Switching
Energy Loss vs. Collector Current**



**Fig. 14. Inductive Switching
Energy Loss vs. Junction Temperature**

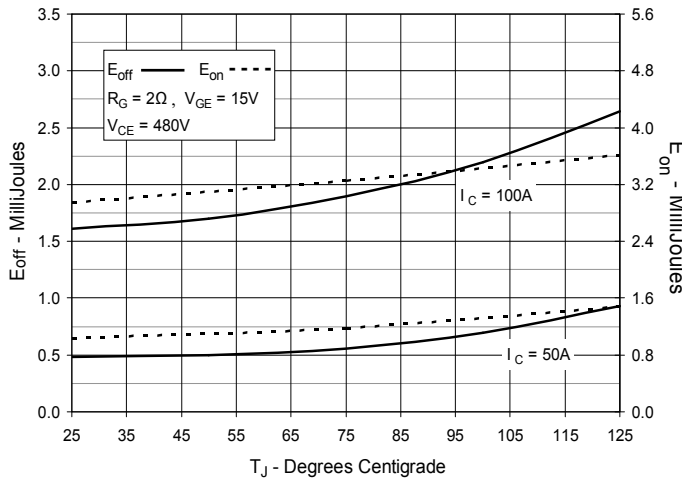

**Fig. 15. Inductive Turn-off
Switching Times vs. Gate Resistance**

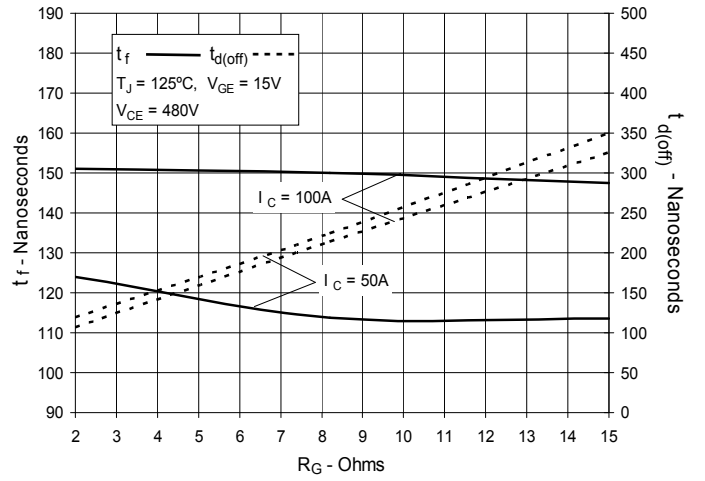

**Fig. 16. Inductive Turn-off
Switching Times vs. Collector Current**

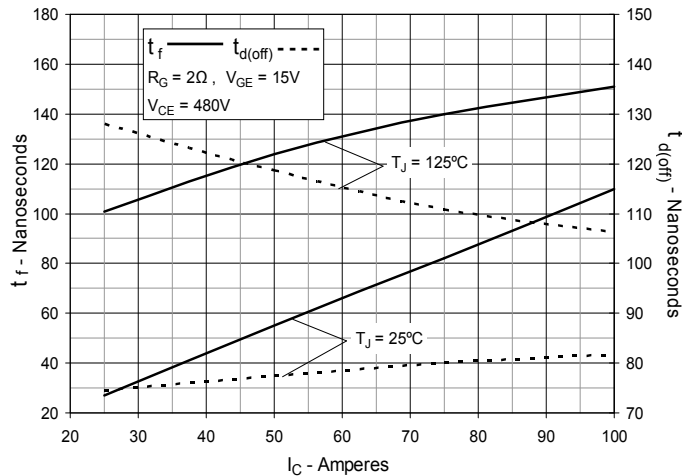

**Fig. 17. Inductive Turn-off
Switching Times vs. Junction Temperature**

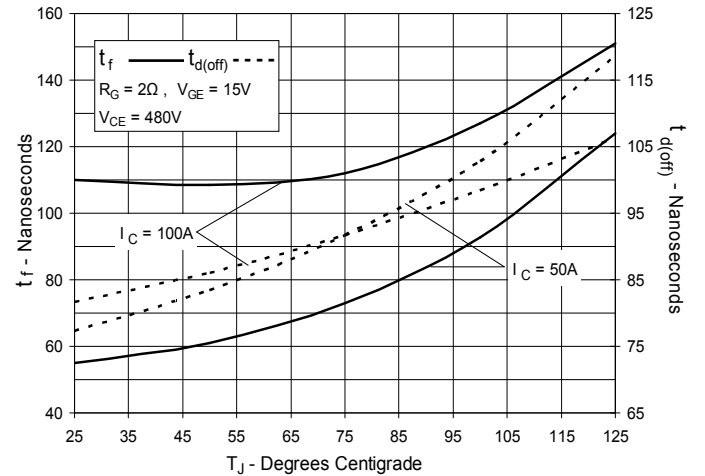

**Fig. 18. Inductive Turn-on
Switching Times vs. Gate Resistance**

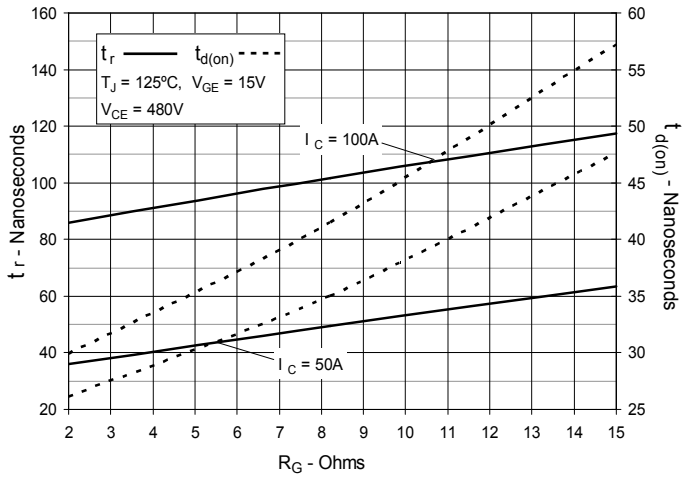

**Fig. 19. Inductive Turn-on
Switching Times vs. Collector Current**

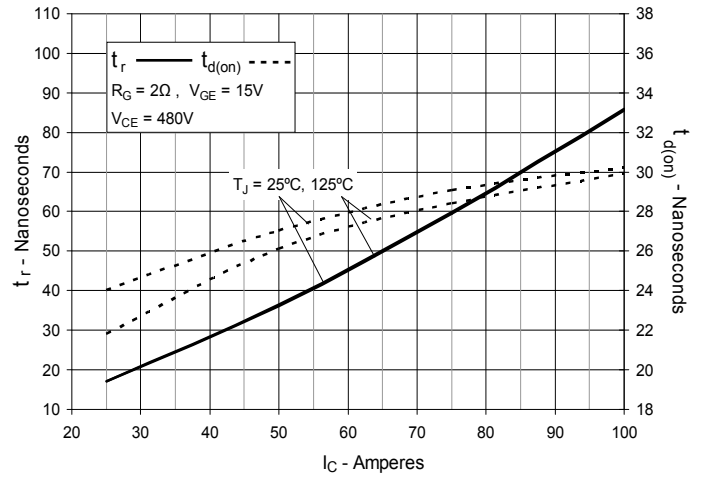

**Fig. 20. Inductive Turn-on
Switching Times vs. Junction Temperature**

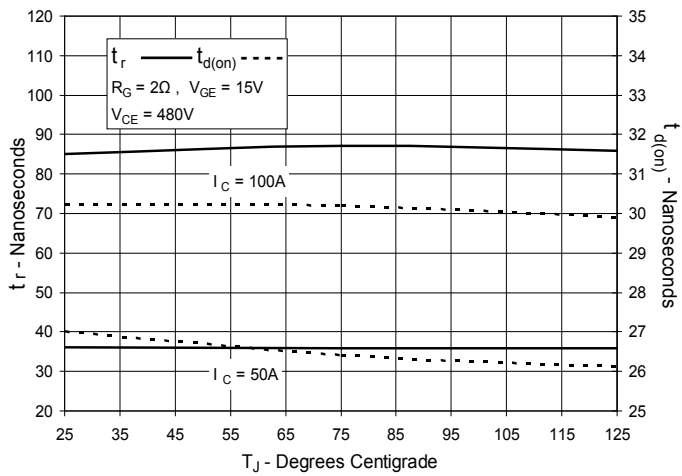

X-ON Electronics

Largest Supplier of Electrical and Electronic Components

Click to view similar products for [IGBT Transistors](#) category:

Click to view products by [IXYS](#) manufacturer:

Other Similar products are found below :

[748152A](#) [APT20GT60BRDQ1G](#) [APT50GT60BRG](#) [NGTB10N60FG](#) [STGFW20V60DF](#) [APT30GP60BG](#) [APT45GR65B2DU30](#)
[GT50JR22\(STA1ES\)](#) [TIG058E8-TL-H](#) [IGW40N120H3FKSA1](#) [VS-CPV364M4KPBF](#) [NGTB25N120FL2WAG](#) [NGTG40N120FL2WG](#)
[RJH60F3DPQ-A0#T0](#) [APT40GR120B2SCD10](#) [APT15GT120BRG](#) [APT20GT60BRG](#) [NGTB75N65FL2WAG](#) [NGTG15N120FL2WG](#)
[IXA30RG1200DHGLB](#) [IXA40RG1200DHGLB](#) [APT70GR65B2DU40](#) [NTE3320](#) [QP12W05S-37A](#) [IHF40N65R5SXXSA1](#) [APT70GR120J](#)
[APT35GP120JDQ2](#) [IKZA40N65RH5XKSA1](#) [IKFW75N65ES5XKSA1](#) [IKFW50N65ES5XKSA1](#) [IKFW50N65EH5XKSA1](#)
[IKFW40N65ES5XKSA1](#) [IKFW60N65ES5XKSA1](#) [IMBG120R090M1HXTMA1](#) [IMBG120R220M1HXTMA1](#) [XD15H120CX1](#)
[XD25H120CX0](#) [XP15PJS120CL1B1](#) [IGW30N60H3FKSA1](#) [STGWA8M120DF3](#) [IGW08T120FKSA1](#) [IGW75N60H3FKSA1](#)
[FGH60N60SMD_F085](#) [FGH75T65UPD](#) [STGWA15H120F2](#) [IKA10N60TXKSA1](#) [IHW20N120R5XKSA1](#) [RJH60D2DPP-M0#T2](#)
[IKP20N60TXKSA1](#) [IHW20N65R5XKSA1](#)