

## High Voltage IGBT

## IXGR6N170A

(Electrically Isolated Tab)

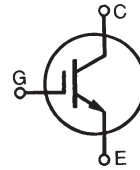

$$V_{CES} = 1700V$$

$$I_{C25} = 5.5A$$

$$V_{CE(sat)} \leq 7.0V$$

$$t_{fi(typ)} = 32ns$$

Symbol	Test Conditions	Maximum Ratings	
$V_{CES}$	$T_C = 25^\circ C$ to $150^\circ C$	1700	V
$V_{CGR}$	$T_J = 25^\circ C$ to $150^\circ C$ , $R_{GE} = 1M\Omega$	1700	V
$V_{GES}$	Continuous	$\pm 20$	V
$V_{GEM}$	Transient	$\pm 30$	V
$I_{C25}$	$T_C = 25^\circ C$	5.5	A
$I_{C110}$	$T_C = 110^\circ C$	2.5	A
$I_{CM}$	$T_C = 25^\circ C$ , 1ms	18	A
<b>SSOA</b>	$V_{GE} = 15V$ , $T_{VJ} = 125^\circ C$ , $R_G = 33\Omega$	$I_{CM} = 12$	A
<b>(RBSOA)</b>	Clamped Inductive Load	@ $0.8 \cdot V_{CES}$	
$t_{SC}$	$T_J = 125^\circ C$ , $V_{CE} = 1200V$ , $V_{GE} = 15V$ , $R_G = 33\Omega$	10	$\mu s$
$P_C$	$T_C = 25^\circ C$	50	W
$T_J$		- 55 ... +150	$^\circ C$
$T_{JM}$		150	$^\circ C$
$T_{stg}$		- 55 ... +150	$^\circ C$
$V_{ISOL}$	50/60 Hz, RMS, t = 1minute $I_{ISOL} < 1mA$ t = 20 seconds	2500 3000	V~ V~
$F_C$	Mounting Force	20..120/4.5..27	N/lb
$T_L$	Maximum Lead Temperature for Soldering	300	$^\circ C$
$T_{SOLD}$	1.6mm (0.062 in.) from Case for 10s	260	$^\circ C$
<b>Weight</b>		5	g

## ISOPLUS247™

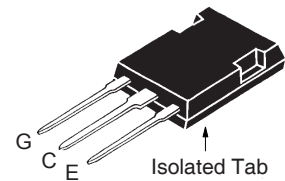

G = Gate      C = Collector  
E = Emitter

## Features

- Silicon Chip on Direct-Copper Bond (DCB) Substrate
- Isolated Mounting Surface
- 2500V~ Electrical Isolation

## Advantages

- High Power Density
- Low Gate Drive Requirement

## Applications

- Power Inverters
- UPS
- Motor Drives
- SMPS
- PFC Circuits
- Welding Machines

Symbol	Test Conditions ( $T_J = 25^\circ C$ Unless Otherwise Specified)	Characteristic Values		
		Min.	Typ.	Max.
$BV_{CES}$	$I_C = 250\mu A$ , $V_{GE} = 0V$	1700		V
$V_{GE(th)}$	$I_C = 250\mu A$ , $V_{CE} = V_{GE}$	3.0		V
$I_{CES}$	$V_{CE} = 0.8 \cdot V_{CES}$ , $V_{GE} = 0V$ Note 2, $T_J = 125^\circ C$			10 $\mu A$ 500 $\mu A$
$I_{GES}$	$V_{CE} = 0V$ , $V_{GE} = \pm 20V$			$\pm 100$ nA
$V_{CE(sat)}$	$I_C = 3A$ , $V_{GE} = 15V$ , Note 1 $T_J = 125^\circ C$		5.4	7.0 V V

Symbol	Test Conditions ( $T_J = 25^\circ\text{C}$ , Unless Otherwise Specified)	Characteristic Values		
		Min.	Typ.	Max.
$g_{fs}$	$I_C = 6\text{A}$ , $V_{CE} = 20\text{V}$ , Note 1	2.0	3.5	S
$C_{ies}$	$V_{CE} = 25\text{V}$ , $V_{GE} = 0\text{V}$ , $f = 1\text{MHz}$		390	pF
$C_{oes}$			20	pF
$C_{res}$			7	pF
$Q_g$	$I_C = 6\text{A}$ , $V_{GE} = 15\text{V}$ , $V_{CE} = 0.5 \cdot V_{CES}$		18.5	nC
$Q_{ge}$			2.8	nC
$Q_{gc}$			8.2	nC
$t_{d(on)}$	<b>Inductive load, <math>T_J = 25^\circ\text{C}</math></b> $I_C = 6\text{A}$ , $V_{GE} = 15\text{V}$ $V_{CE} = 0.5 \cdot V_{CES}$ , $R_G = 33\Omega$ Note 3		46	ns
$t_{ri}$			40	ns
$E_{on}$			0.59	mJ
$t_{d(off)}$			220	400 ns
$t_{fi}$			32	65 ns
$E_{off}$			0.18	0.36 mJ
$t_{d(on)}$	<b>Inductive load, <math>T_J = 125^\circ\text{C}</math></b> $I_C = 6\text{A}$ , $V_{GE} = 15\text{V}$ $V_{CE} = 0.5 \cdot V_{CES}$ , $R_G = 33\Omega$ Note 3		48	ns
$t_{ri}$			43	ns
$E_{on}$			0.62	mJ
$t_{d(off)}$			230	ns
$t_{fi}$			41	ns
$E_{off}$			0.25	mJ
$R_{thJC}$			2.5	$^\circ\text{C/W}$
$R_{thCK}$		0.15		$^\circ\text{C/W}$

### ISOPLUS247 (IXGR) Outline

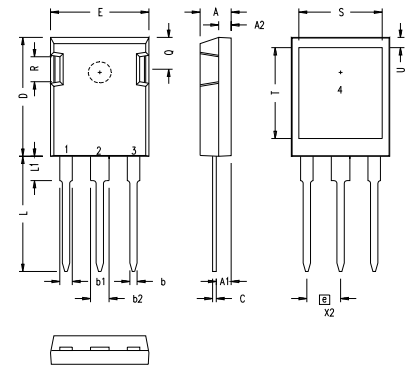

SYM	INCHES		MILLIMETERS	
	MIN	MAX	MIN	MAX
A	.190	.205	4.83	5.21
A1	.090	.100	2.29	2.54
A2	.075	.085	1.91	2.16
b	.045	.055	1.14	1.40
b1	.075	.084	1.91	2.13
b2	.115	.123	2.92	3.12
C	.024	.031	0.61	0.80
D	.819	.840	20.80	21.34
E	.620	.635	15.75	16.13
e	.215 BSC		5.45 BSC	
L	.780	.800	19.81	20.32
L1	.150	.170	3.81	4.32
Q	.220	.244	5.59	6.20
R	.170	.190	4.32	4.83
S	.520	.540	13.21	13.72
T	.620	.640	15.75	16.26
U	.065	.080	1.65	2.03

- 1 - GATE
- 2 - DRAIN (COLLECTOR)
- 3 - SOURCE (EMITTER)
- 4 - NO CONNECTION

NOTE: This drawing will meet all dimensions requirement of JEDEC outline TO-247AD except screw hole.

### Notes:

1. Pulse test,  $t \leq 300\mu\text{s}$ , duty cycle,  $d \leq 2\%$ .
2. Part must be heatsunk for high-temp  $I_{ces}$  measurement.
3. Switching times & energy losses may increase for higher  $V_{CE( Clamp)}$ ,  $T_J$  or  $R_G$ .

### ADVANCE TECHNICAL INFORMATION

The product presented herein is under development. The Technical Specifications offered are derived from a subjective evaluation of the design, based upon prior knowledge and experience, and constitute a "considered reflection" of the anticipated result. IXYS reserves the right to change limits, test conditions, and dimensions without notice.

### IXYS Reserves the Right to Change Limits, Test Conditions, and Dimensions.

IXYS MOSFETs and IGBTs are covered by one or more of the following U.S. patents:	4,835,592	4,931,844	5,049,961	5,237,481	6,162,665	6,404,065 B1	6,683,344	6,727,585	7,005,734 B2	7,157,338B2
	4,850,072	5,017,508	5,063,307	5,381,025	6,259,123 B1	6,534,343	6,710,405 B2	6,759,692	7,063,975 B2	
	4,881,106	5,034,796	5,187,117	5,486,715	6,306,728 B1	6,583,505	6,710,463	6,771,478 B2	7,071,537	

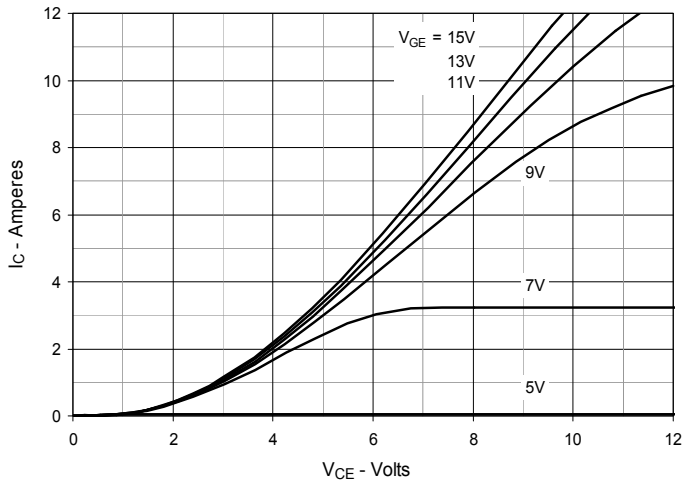
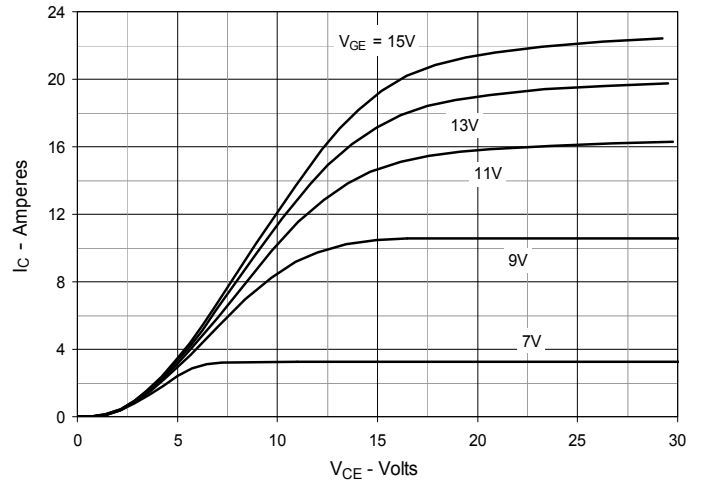
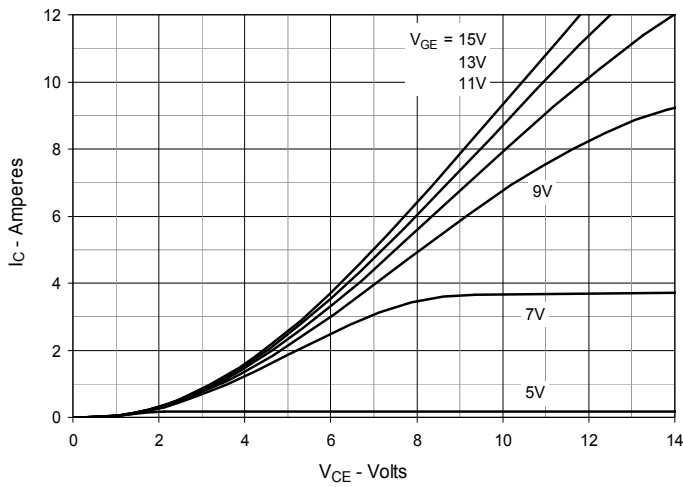
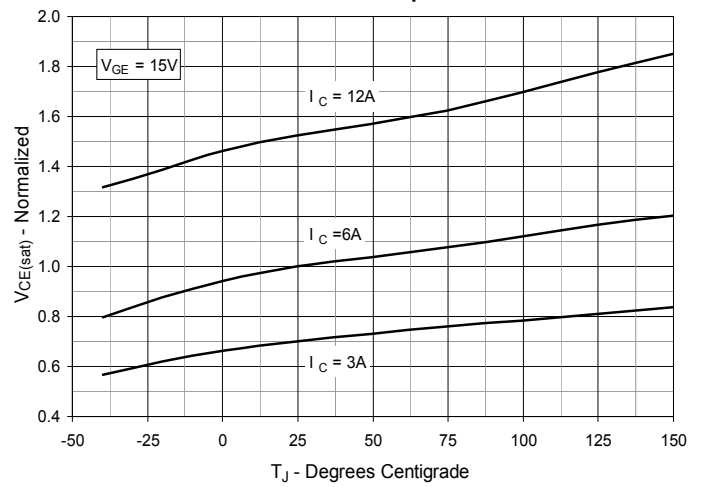
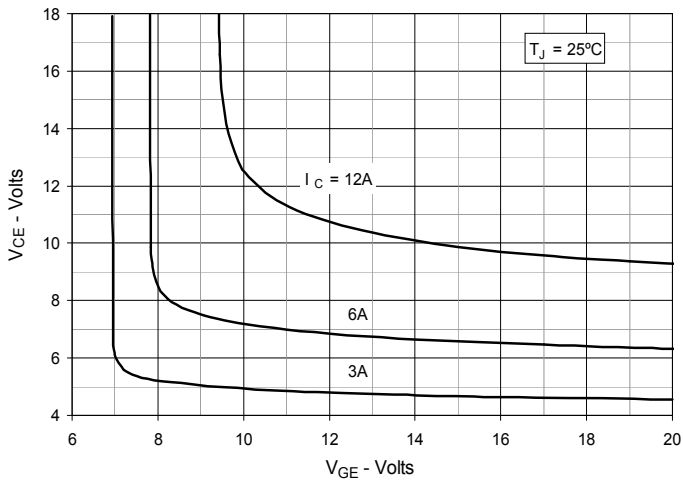
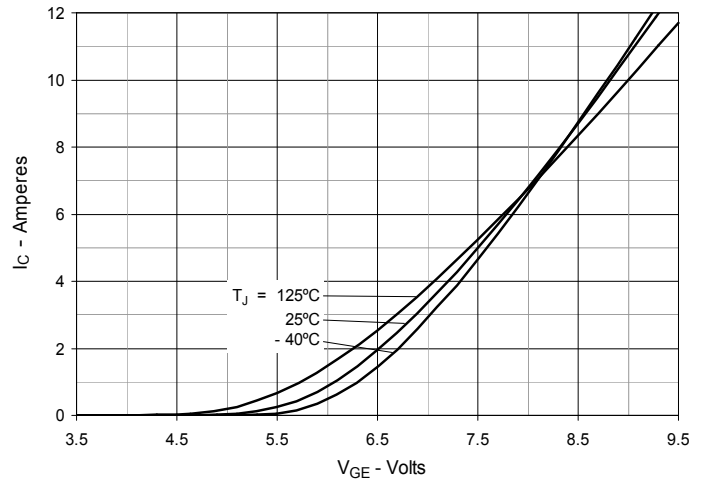
**Fig. 1. Output Characteristics @  $T_J = 25^\circ\text{C}$** 

**Fig. 2. Extended Output Characteristics @  $T_J = 25^\circ\text{C}$** 

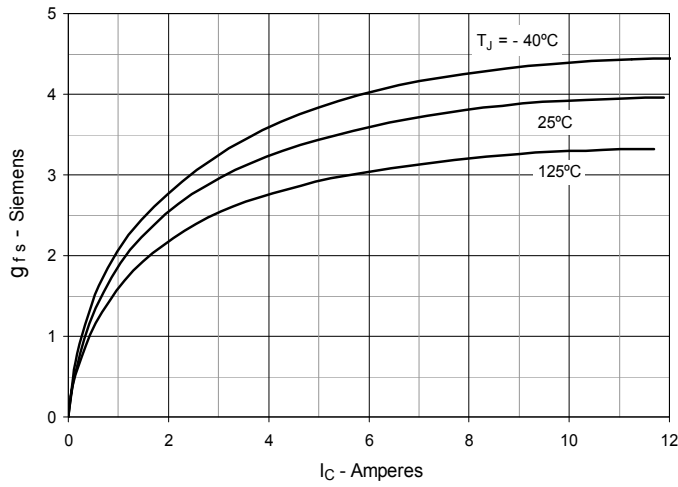
**Fig. 3. Output Characteristics @  $T_J = 125^\circ\text{C}$** 

**Fig. 4. Dependence of  $V_{CE(sat)}$  on Junction Temperature**

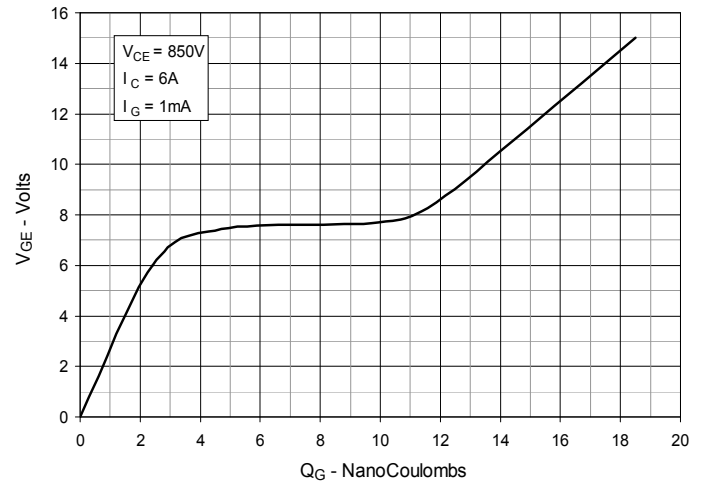
**Fig. 5. Collector-to-Emitter Voltage vs. Gate-to-Emitter Voltage**

**Fig. 6. Input Admittance**

**Fig. 7. Transconductance**



**Fig. 8. Gate Charge**



**Fig. 9. Reverse-Bias Safe Operating Area**

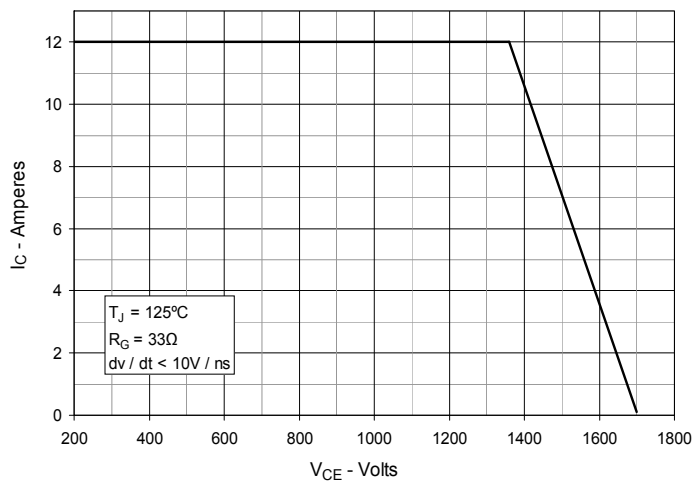

**Fig. 10. Capacitance**

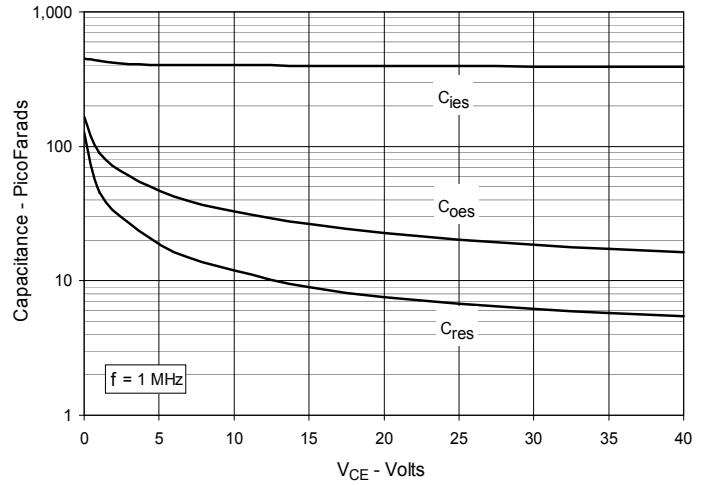

**Fig. 11. Maximum Transient Thermal Impedance**

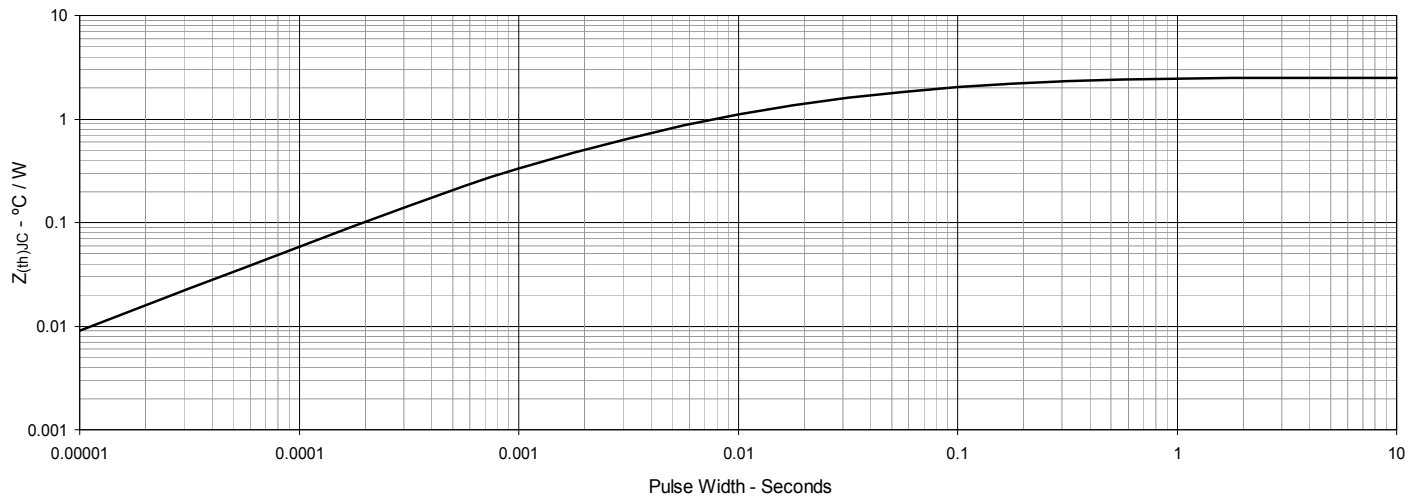

**Fig. 12. Inductive Switching Energy Loss vs. Gate Resistance**

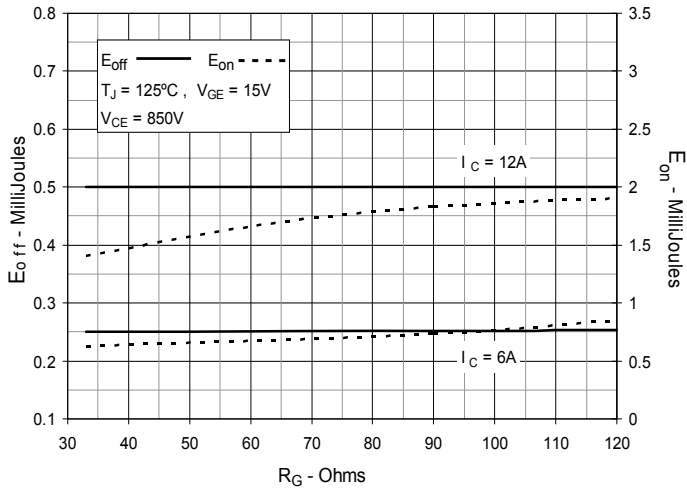

**Fig. 13. Inductive Switching Energy Loss vs. Collector Current**

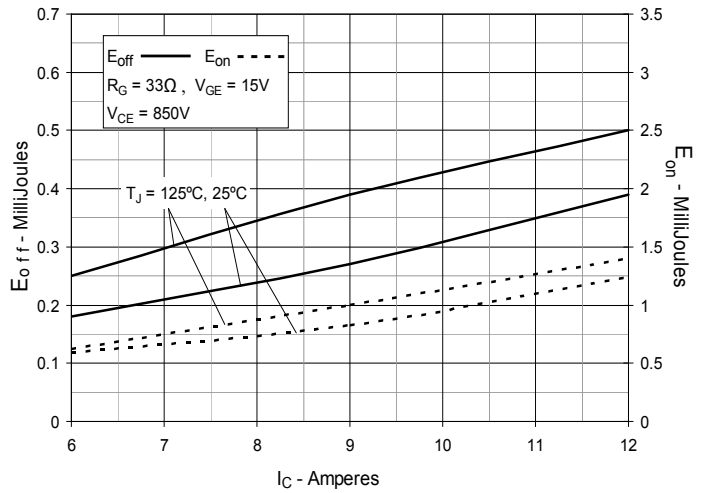

**Fig. 14. Inductive Switching Energy Loss vs. Junction Temperature**

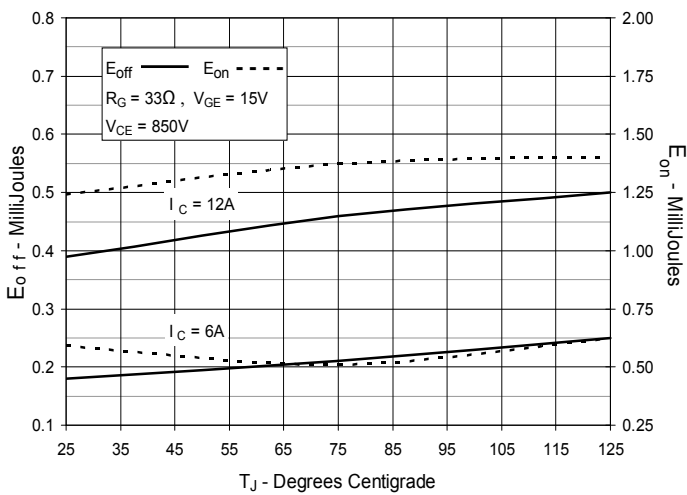



---

Disclaimer Notice - Information furnished is believed to be accurate and reliable. However, users should independently evaluate the suitability of and test each product selected for their own applications. Littelfuse products are not designed for, and may not be used in, all applications. Read complete Disclaimer Notice at [www.littelfuse.com/disclaimer-electronics](http://www.littelfuse.com/disclaimer-electronics).

## X-ON Electronics

Largest Supplier of Electrical and Electronic Components

*Click to view similar products for [IGBT Modules category](#):*

*Click to view products by [IXYS manufacturer](#):*

Other Similar products are found below :

[F3L400R07ME4\\_B22](#) [F4-50R07W2H3\\_B51](#) [FB15R06W1E3](#) [FB20R06W1E3\\_B11](#) [FD1000R33HE3-K](#) [FD400R33KF2C-K](#)  
[FD401R17KF6C\\_B2](#) [FD-DF80R12W1H3\\_B52](#) [FF200R06YE3](#) [FF300R12KE4\\_E](#) [FF450R12ME4P](#) [FF600R12IP4V](#) [FP10R06W1E3\\_B11](#)  
[FP20R06W1E3](#) [FP50R12KT3](#) [FP75R07N2E4\\_B11](#) [FS10R12YE3](#) [FS150R07PE4](#) [FS150R12PT4](#) [FS200R12KT4R](#) [FS50R07N2E4\\_B11](#)  
[FZ1000R33HE3](#) [FZ1800R17KF4](#) [DD250S65K3](#) [DF1000R17IE4](#) [DF1000R17IE4D\\_B2](#) [DF1400R12IP4D](#) [DF200R12PT4\\_B6](#)  
[DF400R07PE4R\\_B6](#) [BSM75GB120DN2\\_E3223c-Se](#) [F3L300R12ME4\\_B22](#) [F3L75R07W2E3\\_B11](#) [F4-50R12KS4\\_B11](#)  
[F475R07W1H3B11ABOMA1](#) [FD1400R12IP4D](#) [FD200R12PT4\\_B6](#) [FD800R33KF2C-K](#) [FF1200R17KP4\\_B2](#) [FF300R17KE3\\_S4](#)  
[FF300R17ME4\\_B11](#) [FF401R17KF6C\\_B2](#) [FF650R17IE4D\\_B2](#) [FF900R12IP4D](#) [FF900R12IP4DV](#) [STGIF7CH60TS-L](#) [FP50R07N2E4\\_B11](#)  
[FS100R07PE4](#) [FS150R07N3E4\\_B11](#) [FS150R17N3E4](#) [FS150R17PE4](#)