

# High Voltage Power MOSFET

**IXTA3N120**  
**IXTP3N120**  
**IXTH3N120**

**V<sub>DSS</sub> = 1200V**  
**I<sub>D25</sub> = 3A**  
**R<sub>DS(on)</sub> ≤ 4.5Ω**

N-Channel Enhancement Mode  
Avalanche Rated  
Fast Intrinsic Diode

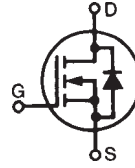

Symbol	Test Conditions	Maximum Ratings	
V <sub>DSS</sub>	T <sub>J</sub> = 25°C to 150°C	1200	V
V <sub>DGR</sub>	T <sub>J</sub> = 25°C to 150°C, R <sub>GS</sub> = 1MΩ	1200	V
V <sub>GSS</sub>	Continuous	±20	V
V <sub>GSM</sub>	Transient	±30	V
I <sub>D25</sub>	T <sub>C</sub> = 25°C	3	A
I <sub>DM</sub>	T <sub>C</sub> = 25°C, Pulse Width Limited by T <sub>JM</sub>	12	A
I <sub>A</sub>	T <sub>C</sub> = 25°C	3	A
E <sub>AS</sub>	T <sub>C</sub> = 25°C	700	mJ
dv/dt	I <sub>S</sub> ≤ I <sub>DM</sub> , V <sub>DD</sub> ≤ V <sub>DSS</sub> , T <sub>J</sub> ≤ 150°C	5	V/ns
P <sub>D</sub>	T <sub>C</sub> = 25°C	200	W
T <sub>J</sub>		-55 ... +150	°C
T <sub>JM</sub>		150	°C
T <sub>stg</sub>		-55 ... +150	°C
T <sub>L</sub>	Maximum Lead Temperature for Soldering	300	°C
T <sub>SOLD</sub>	1.6 mm (0.062in.) from Case for 10s	260	°C
F <sub>C</sub>	Mounting Force (TO-263)	10..65 / 2.2..14.6	N/lb
M <sub>d</sub>	Mounting Torque (TO-247 & TO-220)	1.13 / 10	Nm/lb.in
Weight	TO-263	2.5	g
	TO-220	3.0	g
	TO-247	6.0	g

TO-263 AA (IXTA)

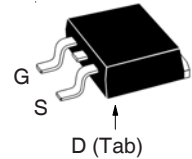

TO-220AB (IXTP)

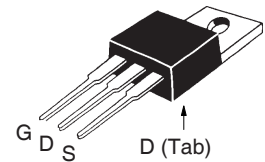

TO-247 (IXTH)

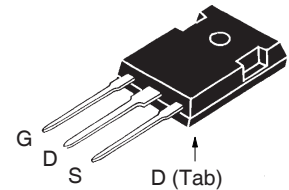

G = Gate      D = Drain  
S = Source    Tab = Drain

## Features

- International Standard Packages
- High Voltage Package
- Fast Intrinsic Diode
- Avalanche Rated
- Molding Epoxies meet UL 94 V-0 Flammability Classification
- High Blocking Voltage

## Advantages

- Easy to Mount
- Space Savings
- High Power Density

## Applications

- High Voltage Power Supplies
- Capacitor Discharge Applications
- Pulse Circuits

Symbol	Test Conditions (T <sub>J</sub> = 25°C, Unless Otherwise Specified)	Characteristic Values		
		Min.	Typ.	Max.
BV <sub>DSS</sub>	V <sub>GS</sub> = 0V, I <sub>D</sub> = 1mA	1200		V
V <sub>GS(th)</sub>	V <sub>DS</sub> = V <sub>GS</sub> , I <sub>D</sub> = 250μA	2.5		5.0 V
I <sub>GSS</sub>	V <sub>GS</sub> = ±20V, V <sub>DS</sub> = 0V			±100 nA
I <sub>DSS</sub>	V <sub>DS</sub> = V <sub>DSS</sub> , V <sub>GS</sub> = 0V T <sub>J</sub> = 125°C			25 μA 1 mA
R <sub>DS(on)</sub>	V <sub>GS</sub> = 10V, I <sub>D</sub> = 0.5 • I <sub>D25</sub> , Note 1			4.5 Ω

Symbol	Test Conditions ( $T_J = 25^\circ\text{C}$ , Unless Otherwise Specified)	Characteristic Values		
		Min.	Typ.	Max
$g_{fs}$	$V_{DS} = 20\text{V}$ , $I_D = 0.5 \cdot I_{D25}$ , Note 1	1.5	2.6	S
$C_{iss}$	$V_{GS} = 0\text{V}$ , $V_{DS} = 25\text{V}$ , $f = 1\text{MHz}$		1100	1350 pF
$C_{oss}$			110	135 pF
$C_{rss}$			40	60 pF
$t_{d(on)}$	<b>Resistive Switching Times</b> $V_{GS} = 10\text{V}$ , $V_{DS} = 0.5 \cdot V_{DSS}$ , $I_D = 0.5 \cdot I_{D25}$ $R_G = 4.7\Omega$ (External)		17	ns
$t_r$			15	ns
$t_{d(off)}$			32	ns
$t_f$			18	ns
$Q_{g(on)}$	$V_{GS} = 10\text{V}$ , $V_{DS} = 0.5 \cdot V_{DSS}$ , $I_D = 0.5 \cdot I_{D25}$		42	nC
$Q_{gs}$			8	nC
$Q_{gd}$			21	nC
$R_{thJC}$				0.62 $^\circ\text{C/W}$
$R_{thCS}$	TO-220		0.50	$^\circ\text{C/W}$
$R_{thCS}$	TO-247		0.21	$^\circ\text{C/W}$

### Source-Drain Diode

Symbol	Test Conditions ( $T_J = 25^\circ\text{C}$ , Unless Otherwise Specified)	Characteristic Values		
		Min.	Typ.	Max
$I_S$	$V_{GS} = 0\text{V}$			3 A
$I_{SM}$	Repetitive, Pulse Width Limited by $T_{JM}$			12 A
$V_{SD}$	$I_F = I_S$ , $V_{GS} = 0\text{V}$ , Note 1			1.5 V
$t_{rr}$	$I_F = 3\text{A}$ , $V_{GS} = 0\text{V}$ , $-di/dt = 100\text{A}/\mu\text{s}$ $V_R = 100\text{V}$		700	ns

Note 1: Pulse test,  $t \leq 300\mu\text{s}$ , duty cycle,  $d \leq 2\%$ .

### TO-263 Outline

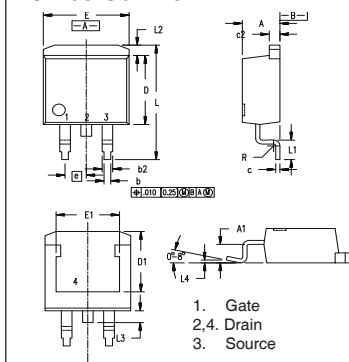

Dim.	Millimeter		Inches	
	Min.	Max.	Min.	Max.
A	4.06	4.83	.160	.190
b	0.51	0.99	.020	.039
b2	1.14	1.40	.045	.055
c	0.40	0.74	.016	.029
c2	1.14	1.40	.045	.055
D	8.64	9.65	.340	.380
D1	8.00	8.89	.280	.320
E	9.65	10.41	.380	.405
E1	6.22	8.13	.270	.320
e	2.54	BSC	.100	BSC
L	14.61	15.88	.575	.625
L1	2.29	2.79	.090	.110
L2	1.02	1.40	.040	.055
L3	1.27	1.78	.050	.070
L4	0	0.13	0	.005

### TO-220 Outline

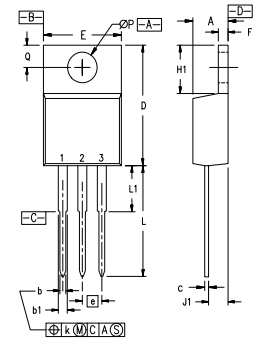

Pins: 1 - Gate 2 - Drain  
3 - Source

SYM	INCHES		MILLIMETERS	
	MIN	MAX	MIN	MAX
A	.170	.190	4.32	4.83
b	.025	.040	0.64	1.02
b1	.045	.065	1.15	1.65
c	.014	.022	0.35	0.56
D	.580	.630	14.73	16.00
E	.390	.420	9.91	10.66
e	.100 BSC		2.54 BSC	
F	.045	.055	1.14	1.40
H1	.230	.270	5.85	6.85
J1	.090	.110	2.29	2.79
k	0	.015	0	0.38
L	.500	.550	12.70	13.97
L1	.110	.230	2.79	5.84
ØP	.139	.161	3.53	4.08
Q	.100	.125	2.54	3.18

### TO-247 Outline

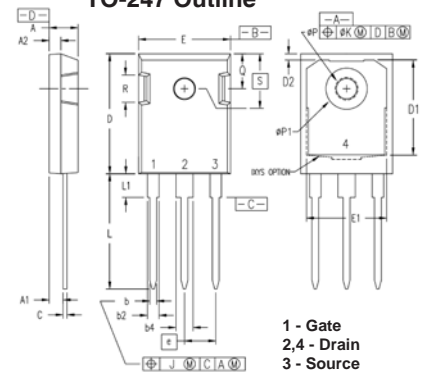

1 - Gate  
2,4 - Drain  
3 - Source

Dim.	Millimeter		Inches	
	min	max	min	max
A	4.70	5.30	0.185	0.209
A1	2.21	2.59	0.087	0.102
A2	1.50	2.49	0.059	0.098
b	0.99	1.40	0.039	0.055
b2	1.65	2.39	0.065	0.094
b4	2.59	3.43	0.102	0.135
c	0.38	0.89	0.015	0.035
D	20.79	21.45	0.819	0.845
D1	13.07	-	0.515	-
D2	0.51	1.35	0.020	0.053
E	15.48	16.24	0.610	0.640
E1	13.45	-	0.53	-
E2	4.31	5.48	0.170	0.216
e	5.45 BSC		0.215 BSC	
L	19.80	20.30	0.078	0.800
L1	-	4.49	-	0.177
Ø P1	3.55	3.65	0.140	0.144
Ø P1	-	7.39	-	0.290
Q	5.38	6.19	0.212	0.244
S	6.14 BSC		0.242 BSC	

IXYS Reserves the Right to Change Limits, Test Conditions, and Dimensions.

IXYS MOSFETs and IGBTs are covered by one or more of the following U.S. patents:	4,835,592	4,931,844	5,049,961	5,237,481	6,162,665	6,404,065B1	6,683,344	6,727,585	7,005,734B2	7,157,338B2
	4,860,072	5,017,508	5,063,307	5,381,025	6,259,123B1	6,534,343	6,710,405B2	6,759,692	7,063,975B2	
	4,881,106	5,034,796	5,187,117	5,486,715	6,306,728B1	6,583,505	6,710,463	6,771,478B2	7,071,537	

Fig. 1. Output Characteristics @  $T_J = 25^\circ\text{C}$

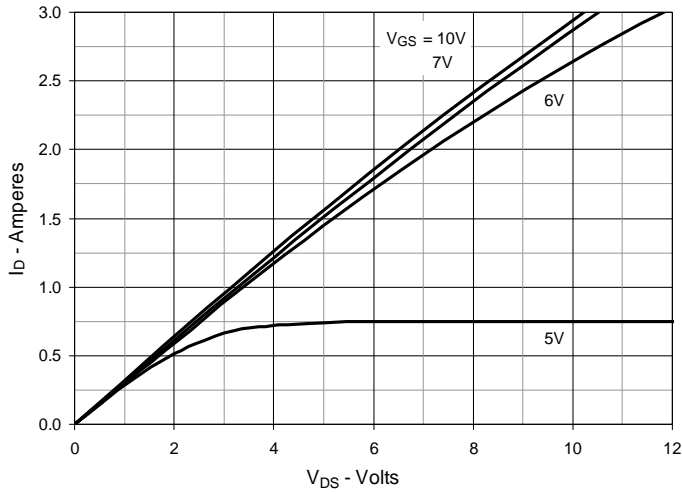

Fig. 2. Extended Output Characteristics @  $T_J = 25^\circ\text{C}$

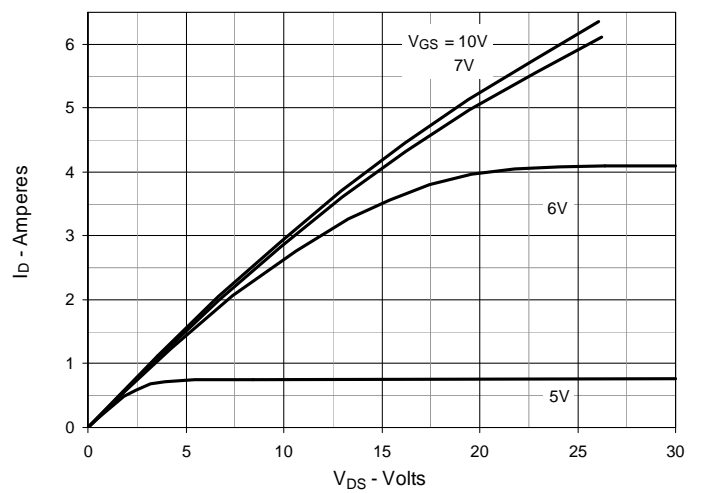

Fig. 3. Output Characteristics @  $T_J = 125^\circ\text{C}$

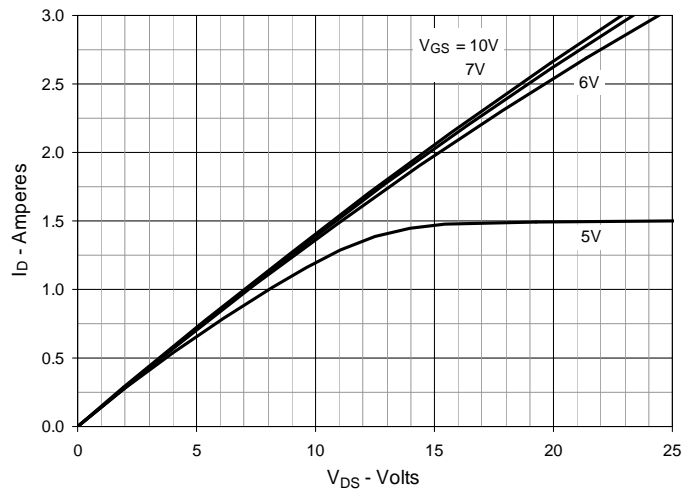

Fig. 4.  $R_{DS(on)}$  Normalized to  $I_D = 1.5\text{A}$  Value vs. Junction Temperature

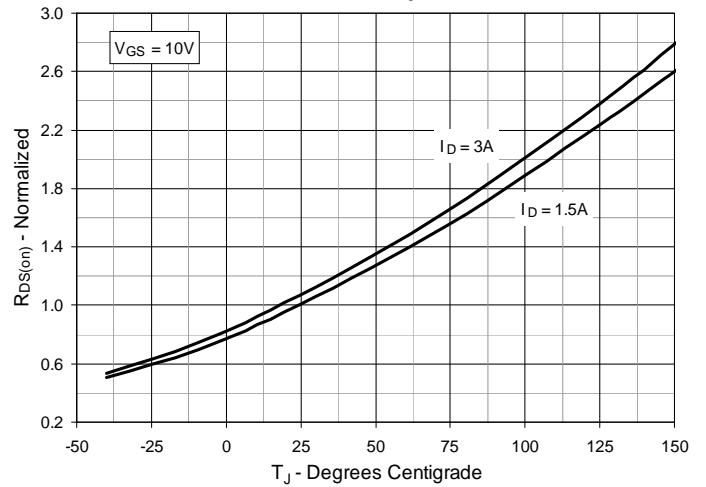

Fig. 5.  $R_{DS(on)}$  Normalized to  $I_D = 1.5\text{A}$  Value vs. Drain Current

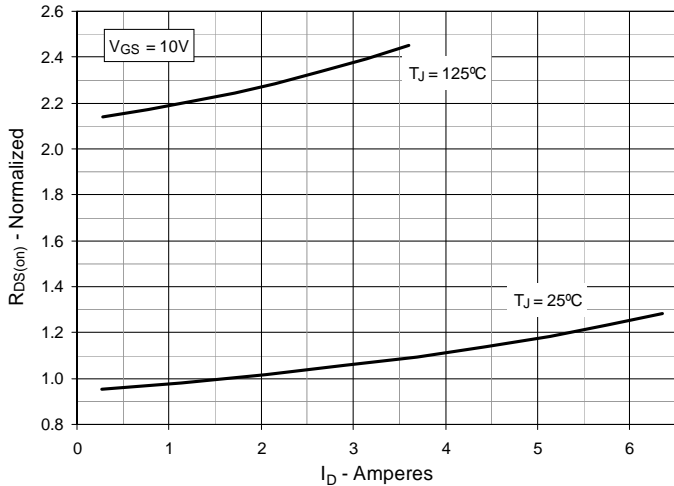

Fig. 6. Maximum Drain Current vs. Case Temperature

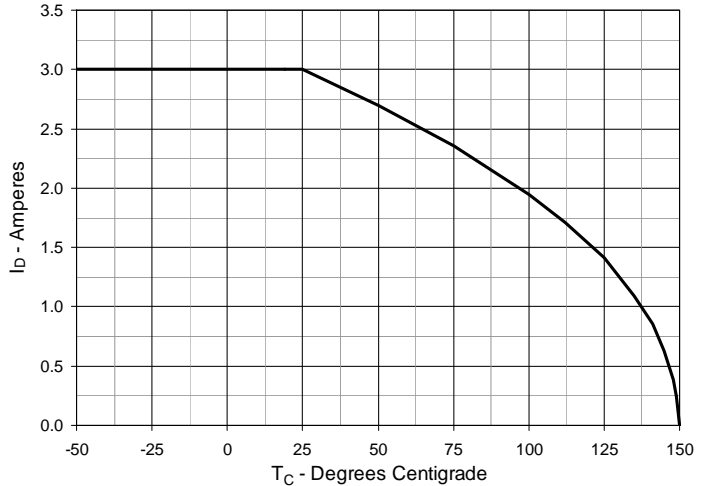

Fig. 7. Input Admittance

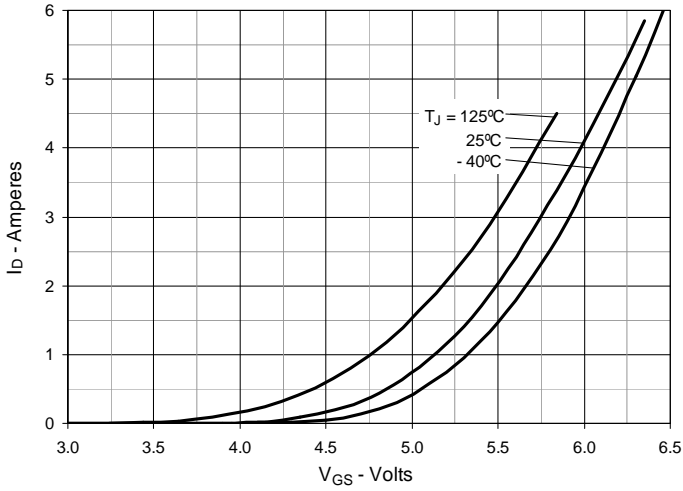

Fig. 8. Transconductance

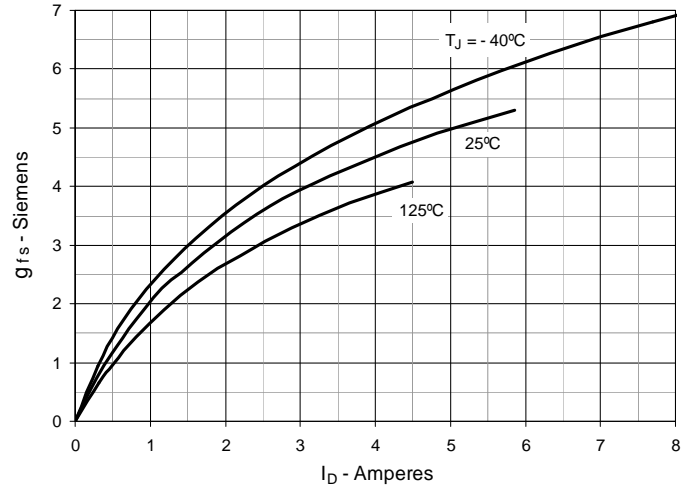

Fig. 9. Forward Voltage Drop of Intrinsic Diode

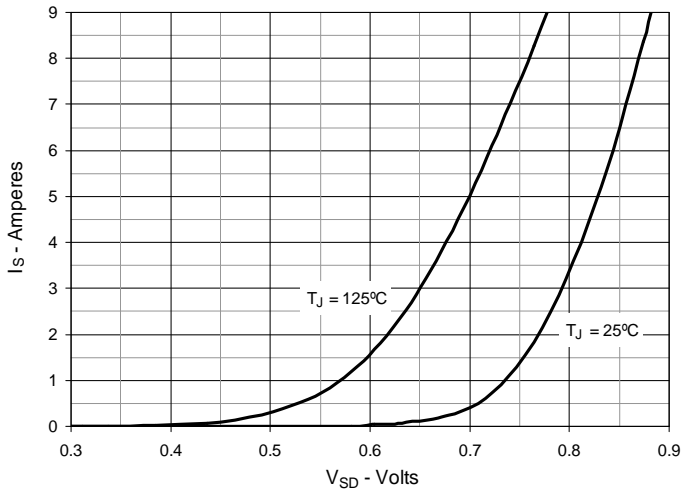

Fig. 10. Gate Charge

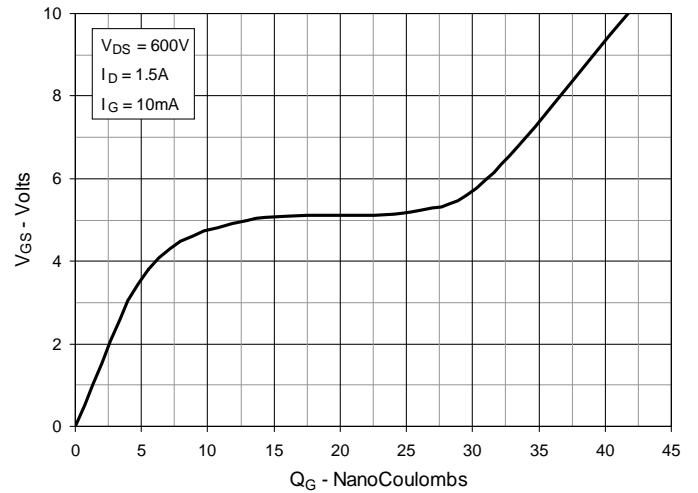

Fig. 11. Capacitance

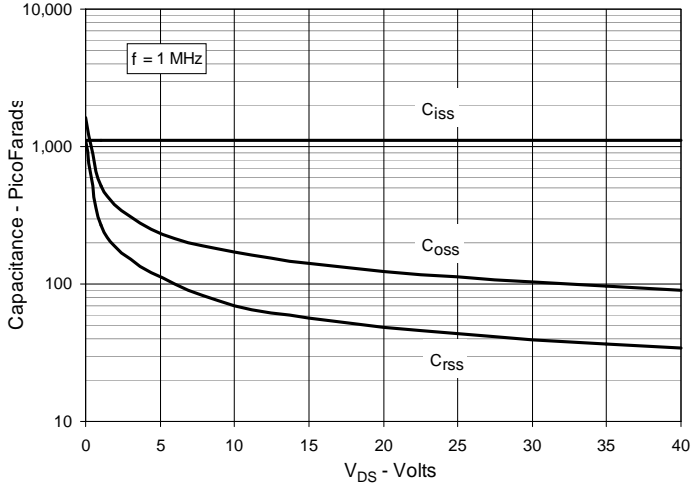

Fig. 12. Forward-Bias Safe Operating Area

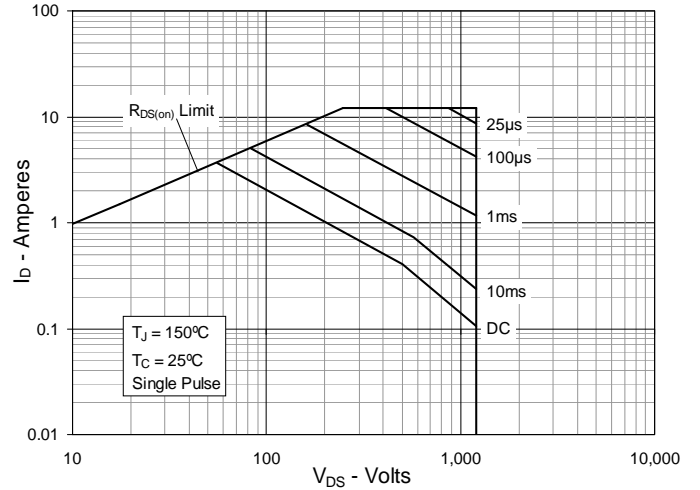
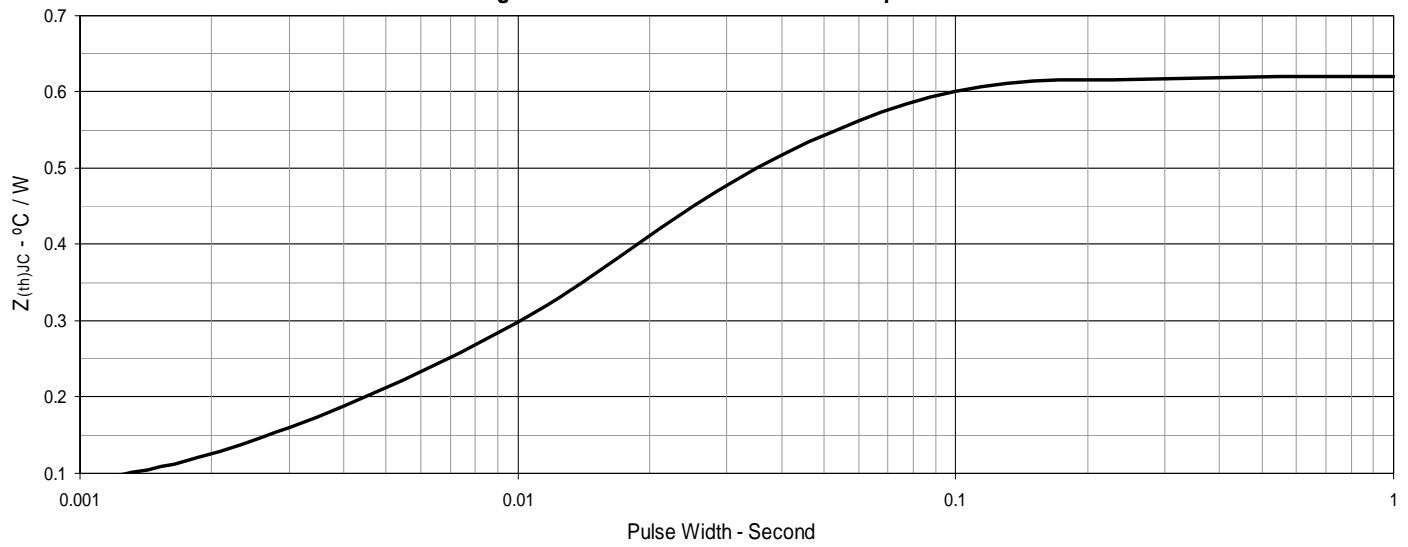

Fig. 13. Maximum Transient Thermal Impedance





---

Disclaimer Notice - Information furnished is believed to be accurate and reliable. However, users should independently evaluate the suitability of and test each product selected for their own applications. Littelfuse products are not designed for, and may not be used in, all applications. Read complete Disclaimer Notice at [www.littelfuse.com/disclaimer-electronics](http://www.littelfuse.com/disclaimer-electronics).

## X-ON Electronics

Largest Supplier of Electrical and Electronic Components

*Click to view similar products for [MOSFET](#) category:*

*Click to view products by [IXYS](#) manufacturer:*

Other Similar products are found below :

[614233C](#) [648584F](#) [IRFD120](#) [JANTX2N5237](#) [FCA20N60\\_F109](#) [FDZ595PZ](#) [2SK2545\(Q,T\)](#) [405094E](#) [423220D](#) [TPCC8103,L1Q\(CM](#)  
[MIC4420CM-TR](#) [VN1206L](#) [614234A](#) [715780A](#) [NTNS3166NZT5G](#) [SSM6J414TU,LF\(T](#) [751625C](#) [BUK954R8-60E](#) [NTE6400](#) [SQJ402EP-](#)  
[T1-GE3](#) [2SK2614\(TE16L1,Q\)](#) [2N7002KW-FAI](#) [DMN1017UCP3-7](#) [EFC2J004NUZTDG](#) [ECH8691-TL-W](#) [FCAB21350L1](#) [P85W28HP2F-](#)  
[7071](#) [DMN1053UCP4-7](#) [NTE221](#) [NTE222](#) [NTE2384](#) [NTE2903](#) [NTE2941](#) [NTE2945](#) [NTE2946](#) [NTE2960](#) [NTE2967](#) [NTE2969](#) [NTE2976](#)  
[NTE6400A](#) [NTE2910](#) [NTE2916](#) [NTE2956](#) [NTE2911](#) [DMN2080UCB4-7](#) [TK10A80W,S4X\(S](#) [SSM6P69NU,LF](#) [DMP22D4UFO-7B](#)  
[DMN1006UCA6-7](#) [DMN16M9UCA6-7](#)