

# Linear™ Power MOSFET IXTH2N150L

## w/Extended FBSOA

$$V_{DSS} = 1500V$$

$$I_{D25} = 2A$$

$$R_{DS(on)} \leq 15\Omega$$

N-Channel Enhancement Mode  
Guaranteed FBSOA  
Avalanche Rated

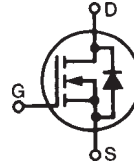

TO-247

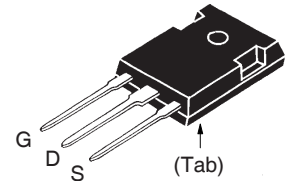

G = Gate      D = Drain  
S = Source    Tab = Drain

| Symbol     | Test Conditions   | Maximum Ratings |                  |
|------------|---|-----------------|------------------|
| $V_{DSS}$  | $T_J = 25^\circ\text{C}$ to $150^\circ\text{C}$                       | 1500            | V                |
| $V_{DGR}$  | $T_J = 25^\circ\text{C}$ to $150^\circ\text{C}$ , $R_{GS} = 1M\Omega$ | 1500            | V                |
| $V_{GSS}$  | Continuous  | $\pm 30$        | V                |
| $V_{GSM}$  | Transient   | $\pm 40$        | V                |
| $I_{D25}$  | $T_C = 25^\circ\text{C}$  | 2               | A                |
| $I_{DM}$   | $T_C = 25^\circ\text{C}$ , Pulse Width Limited by $T_{JM}$            | 6               | A                |
| $P_D$      | $T_C = 25^\circ\text{C}$  | 290             | W                |
| $T_J$      |   | -55 to +150     | $^\circ\text{C}$ |
| $T_{JM}$   |   | +150            | $^\circ\text{C}$ |
| $T_{stg}$  |   | -55 to +150     | $^\circ\text{C}$ |
| $T_L$      | Maximum Lead Temperature for Soldering                                | 300             | $^\circ\text{C}$ |
| $T_{SOLD}$ | Plastic Body for 10s  | 260             | $^\circ\text{C}$ |
| $M_d$      | Mounting Torque (TO-247)  | 1.13 / 10       | Nm/lb.in         |
| Weight     |   | 6               | g                |

### Features

- Designed for Linear Operation
- International Standard Package
- Avalanche Rated
- Guaranteed FBSOA at  $75^\circ\text{C}$

### Advantages

- Easy to Mount
- Space Savings
- High Power Density

### Applications

- DC Choppers
- DC-DC Converters
- Battery Chargers
- Programmable Loads
- Current Regulators
- Temperature and Lighting Controls

| Symbol       | Test Conditions<br>( $T_J = 25^\circ\text{C}$ , Unless Otherwise Specified) | Characteristic Values |      |                   |
|--------------|---|-----------------------|------|-------------------|
|              |   | Min.                  | Typ. | Max.              |
| $BV_{DSS}$   | $V_{GS} = 0V$ , $I_D = 250\mu\text{A}$                                      | 1500                  |      | V                 |
| $V_{GS(th)}$ | $V_{DS} = V_{GS}$ , $I_D = 250\mu\text{A}$                                  | 6.0                   |      | 8.5 V             |
| $I_{GSS}$    | $V_{GS} = \pm 30V$ , $V_{DS} = 0V$  |                       |      | $\pm 100$ nA      |
| $I_{DSS}$    | $V_{DS} = V_{DSS}$ , $V_{GS} = 0V$  |                       |      | 15 $\mu\text{A}$  |
|              | $T_J = 125^\circ\text{C}$   |                       |      | 150 $\mu\text{A}$ |
| $R_{DS(on)}$ | $V_{GS} = 20V$ , $I_D = 0.5 \cdot I_{D25}$ , Note 1                         |                       |      | 15 $\Omega$       |

| Symbol       | Test Conditions<br>( $T_J = 25^\circ\text{C}$ , Unless Otherwise Specified)   | Characteristic Values |      |                    |
|--------------|---|-----------------------|------|--------------------|
|              |   | Min.                  | Typ. | Max.               |
| $g_{fs}$     | $V_{DS} = 20\text{V}$ , $I_D = 0.5 \cdot I_{D25}$ , Note 1  | 0.4                   | 0.7  | S                  |
| $C_{iss}$    | $V_{GS} = 0\text{V}$ , $V_{DS} = 25\text{V}$ , $f = 1\text{MHz}$  |                       | 1470 | pF                 |
| $C_{oss}$    |   |                       | 92   | pF                 |
| $C_{rss}$    |   |                       | 30   | pF                 |
| $t_{d(on)}$  | <b>Resistive Switching Times</b><br>$V_{GS} = 15\text{V}$ , $V_{DS} = 0.5 \cdot V_{DSS}$ , $I_D = 0.5 \cdot I_{D25}$<br>$R_G = 10\Omega$ (External) |                       | 33   | ns                 |
| $t_r$        |   |                       | 55   | ns                 |
| $t_{d(off)}$ |   |                       | 85   | ns                 |
| $t_f$        |   |                       | 84   | ns                 |
| $Q_{g(on)}$  | $V_{GS} = 20\text{V}$ , $V_{DS} = 0.5 \cdot V_{DSS}$ , $I_D = 0.5 \cdot I_{D25}$  |                       | 72   | nC                 |
| $Q_{gs}$     |   |                       | 15   | nC                 |
| $Q_{gd}$     |   |                       | 30   | nC                 |
| $R_{thJC}$   |   |                       | 0.43 | $^\circ\text{C/W}$ |
| $R_{thCS}$   |   | 0.21                  |      | $^\circ\text{C/W}$ |

### TO-247 Outline

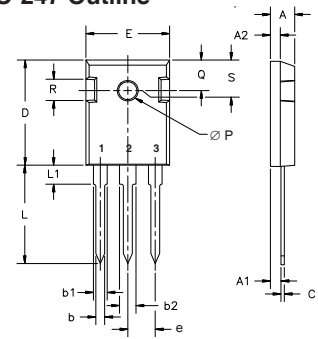

Terminals: 1 - Gate 2 - Drain  
3 - Source

| Dim.           | Millimeter |       | Inches |       |
|----------------|------------|-------|--------|-------|
|                | Min.       | Max.  | Min.   | Max.  |
| A              | 4.7        | 5.3   | .185   | .209  |
| A <sub>1</sub> | 2.2        | 2.54  | .087   | .102  |
| A <sub>2</sub> | 2.2        | 2.6   | .059   | .098  |
| b              | 1.0        | 1.4   | .040   | .055  |
| b <sub>1</sub> | 1.65       | 2.13  | .065   | .084  |
| b <sub>2</sub> | 2.87       | 3.12  | .113   | .123  |
| C              | .4         | .8    | .016   | .031  |
| D              | 20.80      | 21.46 | .819   | .845  |
| E              | 15.75      | 16.26 | .610   | .640  |
| e              | 5.20       | 5.72  | 0.205  | 0.225 |
| L              | 19.81      | 20.32 | .780   | .800  |
| L1             |            | 4.50  |        | .177  |
| ∅P             | 3.55       | 3.65  | .140   | .144  |
| Q              | 5.89       | 6.40  | 0.232  | 0.252 |
| R              | 4.32       | 5.49  | .170   | .216  |
| S              | 6.15       | BSC   | .242   | BSC   |

### Safe Operating Area Specification

| Symbol | Test Conditions   | Characteristic Values |      |      |
|--------|---|-----------------------|------|------|
|        |   | Min.                  | Typ. | Max. |
| SOA    | $V_{DS} = 1200\text{V}$ , $I_D = 0.10\text{A}$ , $T_C = 75^\circ\text{C}$ , $T_P = 5\text{s}$ | 120                   |      | W    |

### Source-Drain Diode

| Symbol   | Test Conditions<br>( $T_J = 25^\circ\text{C}$ , Unless Otherwise Specified)                            | Characteristic Values |      |               |
|----------|--|-----------------------|------|---------------|
|          |  | Min.                  | Typ. | Max.          |
| $I_S$    | $V_{GS} = 0\text{V}$   |                       |      | 2 A           |
| $I_{SM}$ | Repetitive, Pulse Width Limited by $T_{JM}$  |                       |      | 8 A           |
| $V_{SD}$ | $I_F = I_S$ , $V_{GS} = 0\text{V}$ , Note 1  |                       |      | 1.5 V         |
| $t_{rr}$ | $I_F = 2\text{A}$ , $-di/dt = 100\text{A}/\mu\text{s}$ ,<br>$V_R = 100\text{V}$ , $V_{GS} = 0\text{V}$ |                       | 1.86 | $\mu\text{s}$ |
| $I_{RM}$ |  |                       | 24   | A             |
| $Q_{RM}$ |  |                       | 22   | $\mu\text{C}$ |

Note 1. Pulse test,  $t \leq 300\mu\text{s}$ , duty cycle,  $d \leq 2\%$ .

### ADVANCE TECHNICAL INFORMATION

The product presented herein is under development. The Technical Specifications offered are derived from a subjective evaluation of the design, based upon prior knowledge and experience, and constitute a "considered reflection" of the anticipated result. IXYS reserves the right to change limits, test conditions, and dimensions without notice.

IXYS Reserves the Right to Change Limits, Test Conditions, and Dimensions.

|  |           |           |           |           |              |              |              |              |              |             |
|--|-----------|-----------|-----------|-----------|--------------|--------------|--------------|--------------|--------------|-------------|
| IXYS MOSFETs and IGBTs are covered by one or more of the following U.S. patents: | 4,835,592 | 4,931,844 | 5,049,961 | 5,237,481 | 6,162,665    | 6,404,065 B1 | 6,683,344    | 6,727,585    | 7,005,734 B2 | 7,157,338B2 |
|  | 4,860,072 | 5,017,508 | 5,063,307 | 5,381,025 | 6,259,123 B1 | 6,534,343    | 6,710,405 B2 | 6,759,692    | 7,063,975 B2 |             |
|  | 4,881,106 | 5,034,796 | 5,187,117 | 5,486,715 | 6,306,728 B1 | 6,583,505    | 6,710,463    | 6,771,478 B2 | 7,071,537    |             |

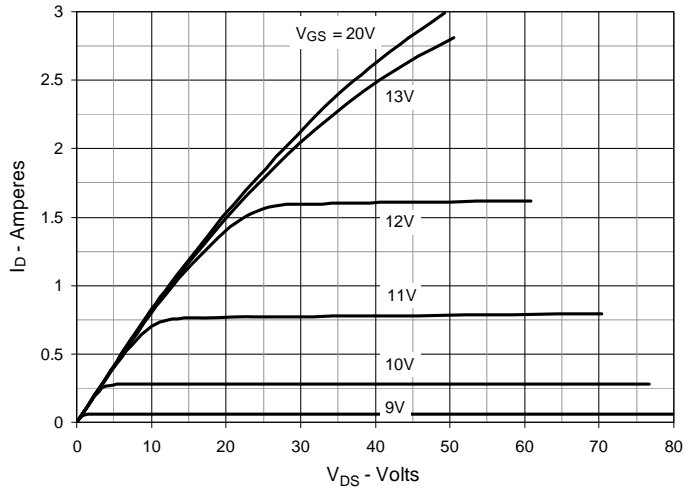
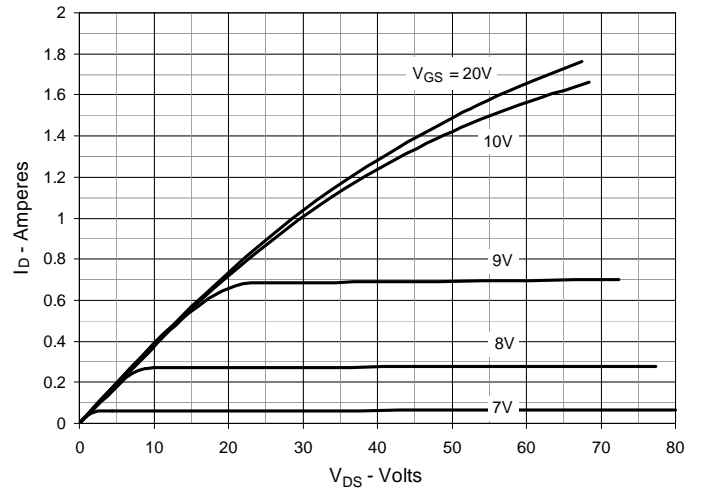
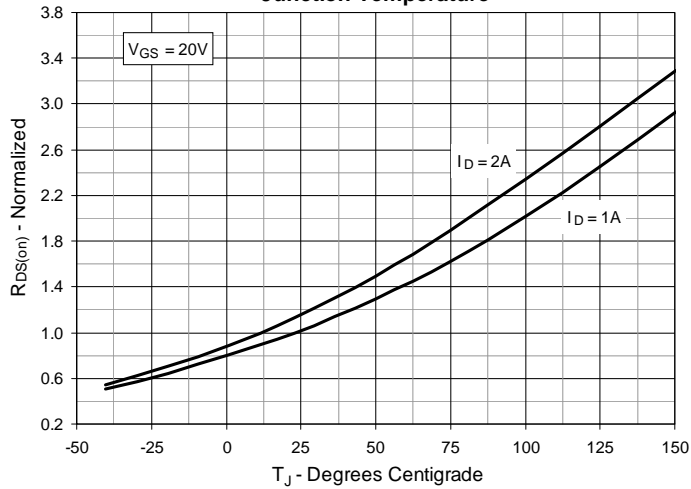
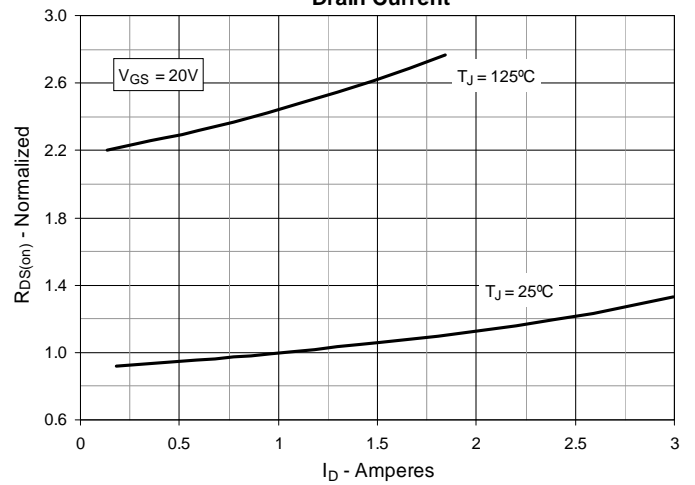
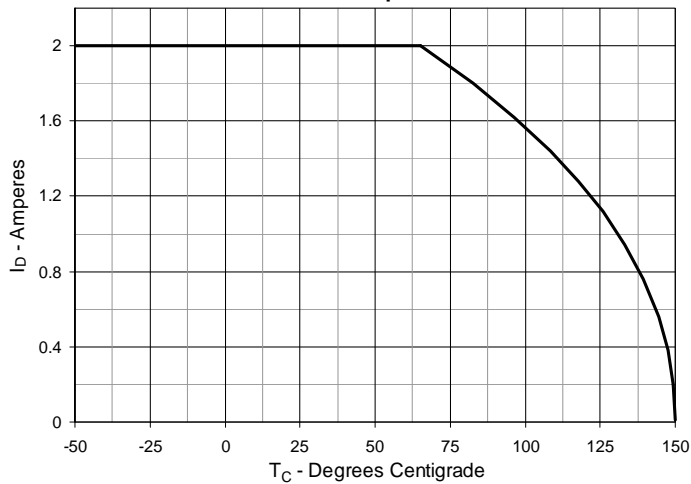
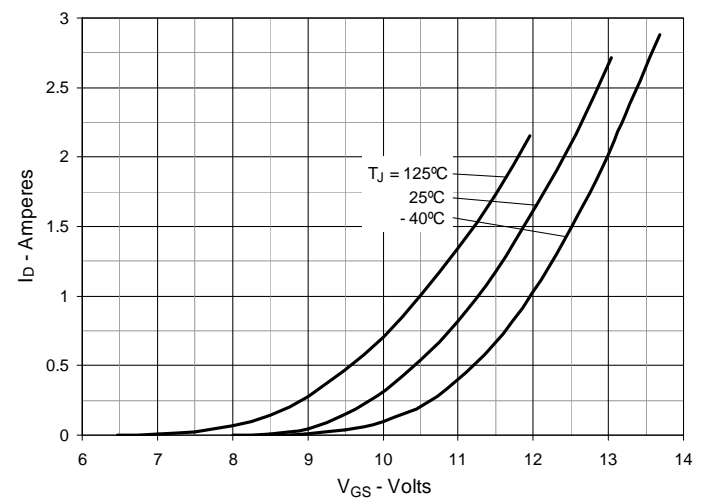
**Fig. 1. Output Characteristics @  $T_J = 25^\circ\text{C}$** 

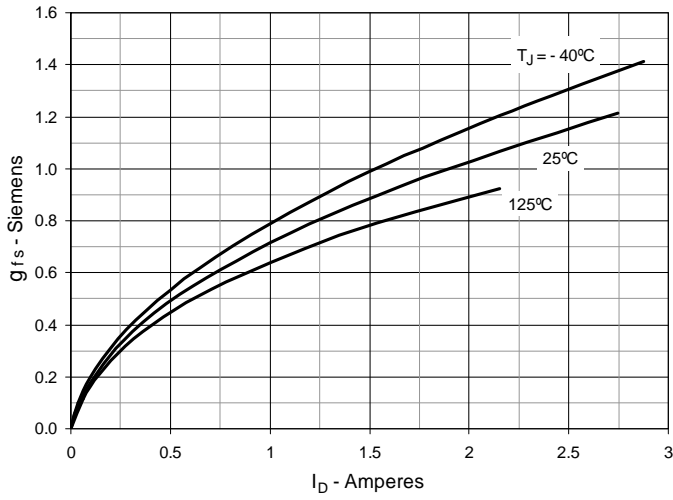
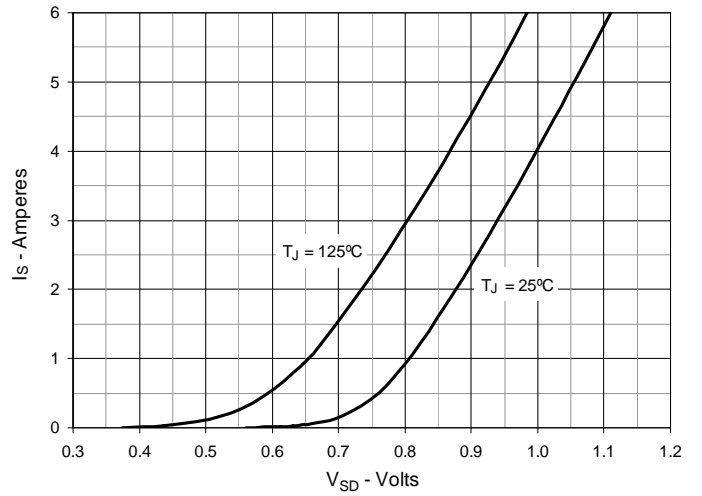
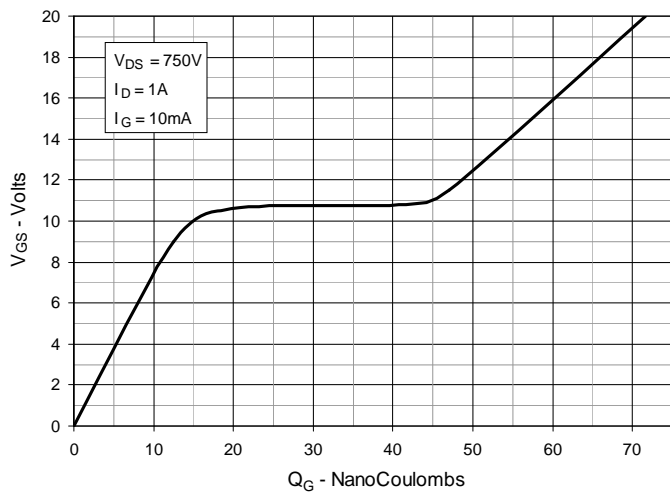
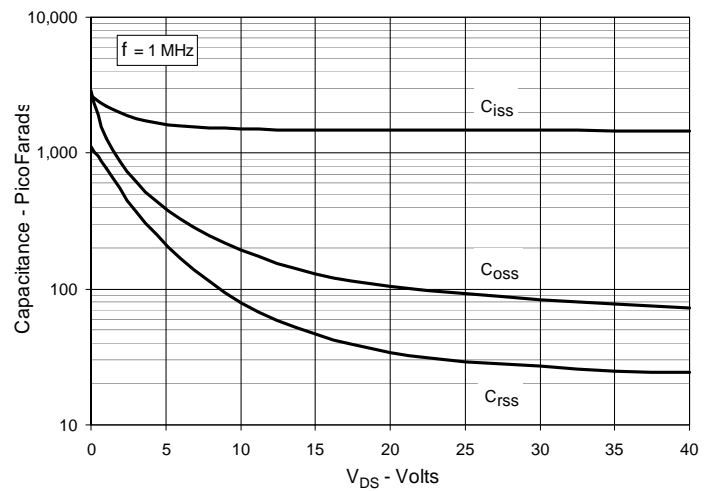
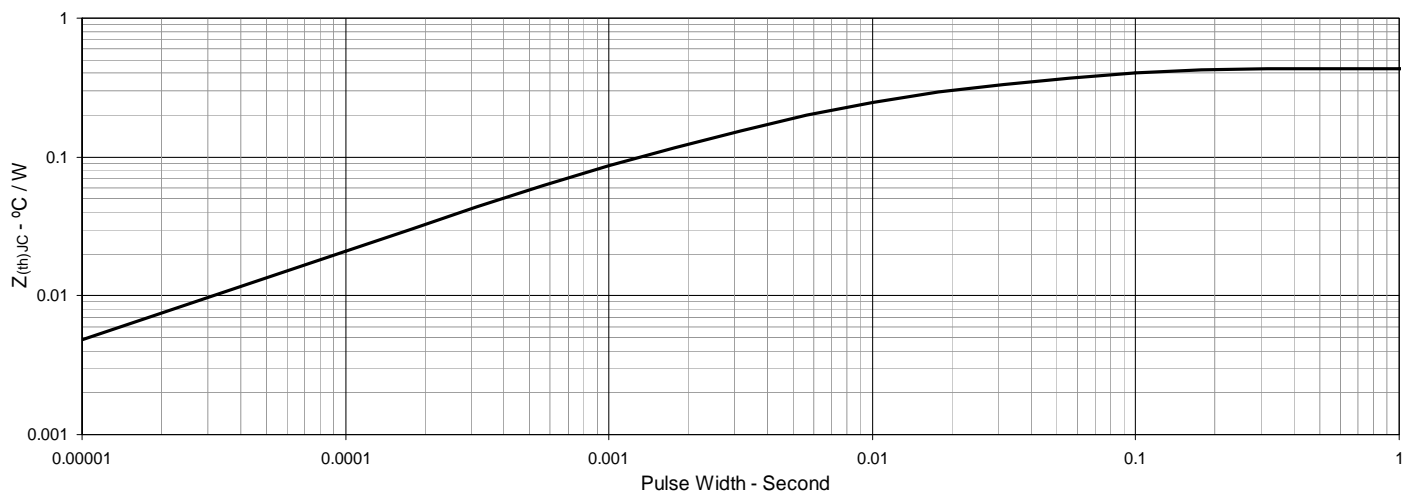
**Fig. 2. Output Characteristics @  $T_J = 125^\circ\text{C}$** 

**Fig. 3.  $R_{DS(on)}$  Normalized to  $I_D = 1\text{A}$  Value vs. Junction Temperature**

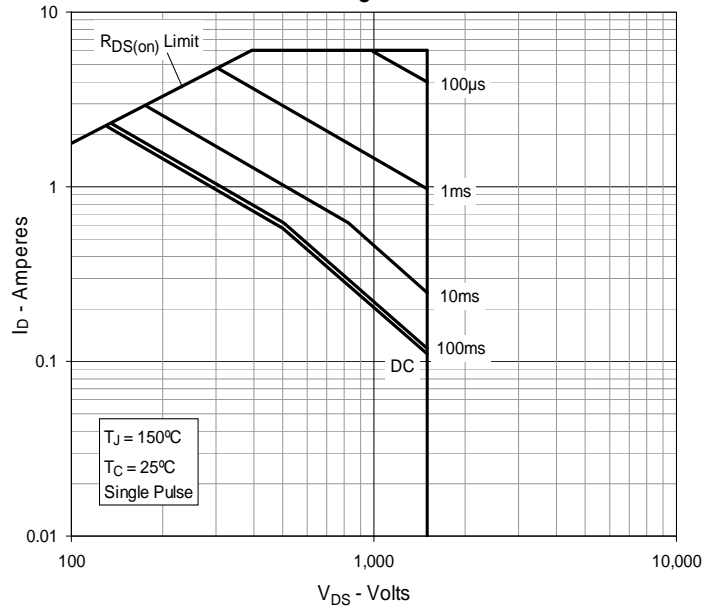
**Fig. 4.  $R_{DS(on)}$  Normalized to  $I_D = 1\text{A}$  Value vs. Drain Current**

**Fig. 5. Maximum Drain Current vs. Case Temperature**

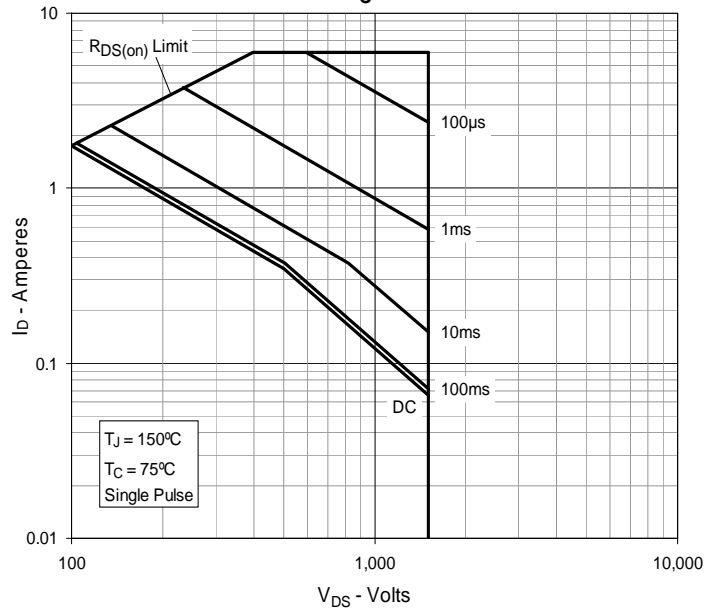
**Fig. 6. Input Admittance**

**Fig. 7. Transconductance**

**Fig. 8. Forward Voltage Drop of Intrinsic Diode**

**Fig. 9. Gate Charge**

**Fig. 10. Capacitance**

**Fig. 11. Maximum Transient Thermal Impedance**

**Fig. 12. Forward-Bias Safe Operating Area**  
@  $T_C = 25^\circ\text{C}$



**Fig. 13. Forward-Bias Safe Operating Area**  
@  $T_C = 75^\circ\text{C}$



## X-ON Electronics

Largest Supplier of Electrical and Electronic Components

*Click to view similar products for [MOSFET](#) category:*

*Click to view products by [IXYS](#) manufacturer:*

Other Similar products are found below :

[614233C](#) [648584F](#) [IRFD120](#) [JANTX2N5237](#) [FCA20N60\\_F109](#) [FDZ595PZ](#) [2SK2545\(Q,T\)](#) [405094E](#) [423220D](#) [TPCC8103,L1Q\(CM](#)  
[MIC4420CM-TR](#) [VN1206L](#) [SBVS138LT1G](#) [614234A](#) [715780A](#) [NTNS3166NZT5G](#) [SSM6J414TU,LF\(T](#) [751625C](#) [BUK954R8-60E](#)  
[NTE6400](#) [SQJ402EP-T1-GE3](#) [2SK2614\(Te16L1,Q\)](#) [2N7002KW-FAI](#) [DMN1017UCP3-7](#) [EFC2J004NUZTDG](#) [ECH8691-TL-W](#)  
[FCAB21350L1](#) [P85W28HP2F-7071](#) [DMN1053UCP4-7](#) [NTE221](#) [NTE222](#) [NTE2384](#) [NTE2903](#) [NTE2941](#) [NTE2945](#) [NTE2946](#) [NTE2960](#)  
[NTE2967](#) [NTE2969](#) [NTE2976](#) [NTE455](#) [NTE6400A](#) [NTE2910](#) [NTE2916](#) [NTE2956](#) [NTE2911](#) [DMN2080UCB4-7](#) [TK10A80W,S4X\(S](#)  
[SSM6P69NU,LF](#) [DMP22D4UFO-7B](#)