

X4-Class Power MOSFET™

IXTA100N15X4 IXTP100N15X4

$V_{DSS} = 150V$
 $I_{D25} = 100A$
 $R_{DS(on)} \leq 11.5m\Omega$

N-Channel Enhancement Mode
 Avalanche Rated

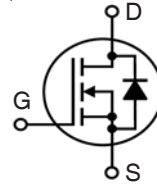

Symbol	Test Conditions	Maximum Ratings	
V_{DSS}	$T_J = 25^\circ C$ to $175^\circ C$	150	V
V_{DGR}	$T_J = 25^\circ C$ to $175^\circ C$, $R_{GS} = 1M\Omega$	150	V
V_{GSS}	Continuous	± 20	V
V_{GSM}	Transient	± 30	V
I_{D25}	$T_C = 25^\circ C$	100	A
I_{DM}	$T_C = 25^\circ C$, Pulse Width Limited by T_{JM}	180	A
I_A	$T_C = 25^\circ C$	50	A
E_{AS}	$T_C = 25^\circ C$	800	mJ
dv/dt	$I_S \leq I_{DM}$, $V_{DD} \leq V_{DSS}$, $T_J \leq 150^\circ C$	50	V/ns
P_D	$T_C = 25^\circ C$	375	W
T_J		-55 ... +175	$^\circ C$
T_{JM}		175	$^\circ C$
T_{stg}		-55 ... +175	$^\circ C$
T_L	Maximum Lead Temperature for Soldering	300	$^\circ C$
T_{SOLD}	1.6 mm (0.062in.) from Case for 10s	260	$^\circ C$
F_C	Mounting Force (TO-263)	10..65 / 2.2..14.6	N/lb
M_d	Mounting Torque (TO-220)	1.13 / 10	Nm/lb.in
Weight	TO-263	2.5	g
	TO-220	3.0	g

TO-263
(IXTA)

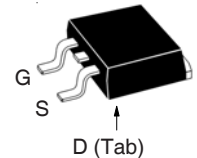

TO-220
(IXTP)

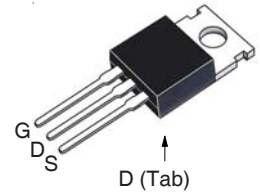

G = Gate D = Drain
 S = Source Tab = Drain

Features

- International Standard Packages
- Low $R_{DS(ON)}$ and Q_G
- Avalanche Rated
- Low Package Inductance

Advantages

- High Power Density
- Easy to Mount
- Space Savings

Applications

- Switch-Mode and Resonant-Mode Power Supplies
- DC-DC Converters
- PFC Circuits
- AC and DC Motor Drives
- Robotics and Servo Controls

Symbol	Test Conditions ($T_J = 25^\circ C$, Unless Otherwise Specified)	Characteristic Values		
		Min.	Typ.	Max.
BV_{DSS}	$V_{GS} = 0V$, $I_D = 250\mu A$	150		V
$V_{GS(th)}$	$V_{DS} = V_{GS}$, $I_D = 250\mu A$	2.5		4.5 V
I_{GSS}	$V_{GS} = \pm 20V$, $V_{DS} = 0V$			± 100 nA
I_{DSS}	$V_{DS} = V_{DSS}$, $V_{GS} = 0V$ $T_J = 150^\circ C$			10 μA 500 μA
$R_{DS(on)}$	$V_{GS} = 10V$, $I_D = 0.5 \cdot I_{D25}$, Notes 1 & 2	9.2	11.5	$m\Omega$

Symbol	Test Conditions ($T_J = 25^\circ\text{C}$, Unless Otherwise Specified)	Characteristic Values		
		Min.	Typ.	Max
g_{fs}	$V_{DS} = 10\text{V}$, $I_D = 50\text{A}$, Note 1	58	96	S
R_{Gi}	Gate Input Resistance		4.1	Ω
C_{iss}	} $V_{GS} = 0\text{V}$, $V_{DS} = 25\text{V}$, $f = 1\text{MHz}$		3970	pF
C_{oss}			650	pF
C_{rss}			1.1	pF
Effective Output Capacitance				
$C_{o(er)}$	Energy related	} $V_{GS} = 0\text{V}$ $V_{DS} = 0.8 \cdot V_{DSS}$	450	pF
$C_{o(tr)}$	Time related		1760	pF
Resistive Switching Times				
$t_{d(on)}$	} $V_{GS} = 10\text{V}$, $V_{DS} = 0.5 \cdot V_{DSS}$, $I_D = 0.5 \cdot I_{D25}$ $R_G = 10\Omega$ (External)		18	ns
t_r			7	ns
$t_{d(off)}$			120	ns
t_f			10	ns
$Q_{g(on)}$	} $V_{GS} = 10\text{V}$, $V_{DS} = 0.5 \cdot V_{DSS}$, $I_D = 0.5 \cdot I_{D25}$		74	nC
Q_{gs}			18	nC
Q_{gd}			18	nC
R_{thJC}	TO-220			0.40 $^\circ\text{C/W}$
R_{thCS}			0.50	$^\circ\text{C/W}$

Source-Drain Diode

Symbol	Test Conditions ($T_J = 25^\circ\text{C}$, Unless Otherwise Specified)	Characteristic Values		
		Min.	Typ.	Max
I_S	$V_{GS} = 0\text{V}$			100 A
I_{SM}	Repetitive, pulse Width Limited by T_{JM}			400 A
V_{SD}	$I_F = I_S$, $V_{GS} = 0\text{V}$, Note 1			1.4 V
t_{rr}	} $I_F = 50\text{A}$, $-di/dt = 100\text{A}/\mu\text{s}$ $V_R = 100\text{V}$		90	ns
Q_{RM}			300	nC
I_{RM}			6.7	A

- Notes: 1. Pulse test, $t \leq 300\mu\text{s}$, duty cycle, $d \leq 2\%$.
2. On through-hole packages, $R_{DS(on)}$ Kelvin test contact location must be 5mm or less from the package body.

IXYS Reserves the Right to Change Limits, Test Conditions, and Dimensions.

IXYS MOSFETs and IGBTs are covered by one or more of the following U.S. patents:	4,835,592	4,931,844	5,049,961	5,237,481	6,162,665	6,404,065B1	6,683,344	6,727,585	7,005,734B2	7,157,338B2
	4,860,072	5,017,508	5,063,307	5,381,025	6,259,123B1	6,534,343	6,710,405B2	6,759,692	7,063,975B2	
	4,881,106	5,034,796	5,187,117	5,486,715	6,306,728B1	6,583,505	6,710,463	6,771,478B2	7,071,537	

Fig. 1. Output Characteristics @ $T_J = 25^\circ\text{C}$

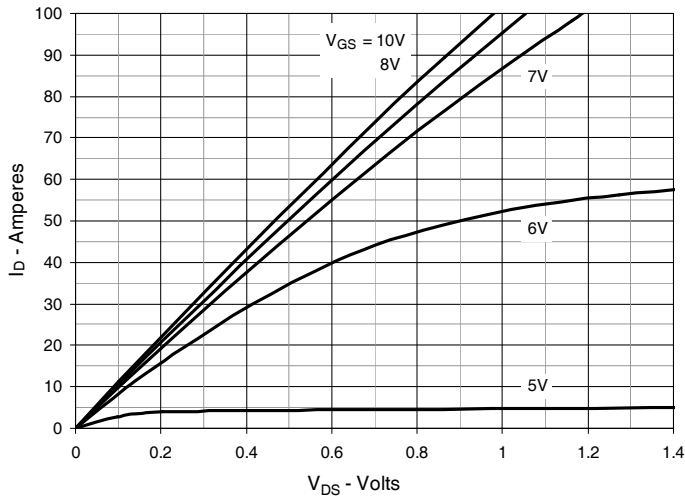

Fig. 2. Extended Output Characteristics @ $T_J = 25^\circ\text{C}$

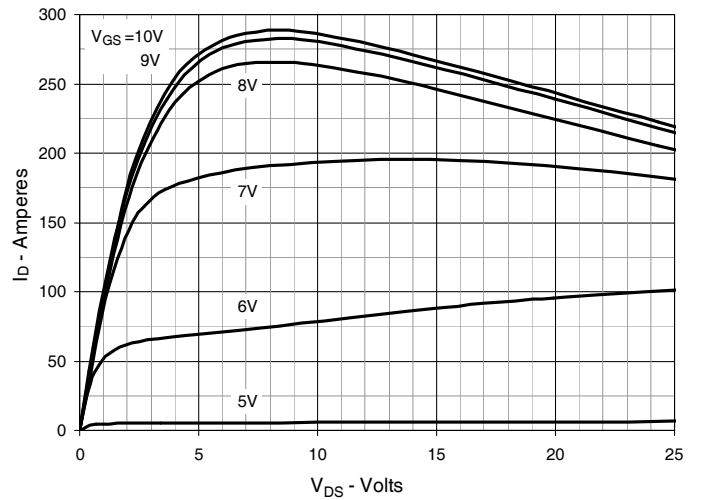

Fig. 3. Output Characteristics @ $T_J = 150^\circ\text{C}$

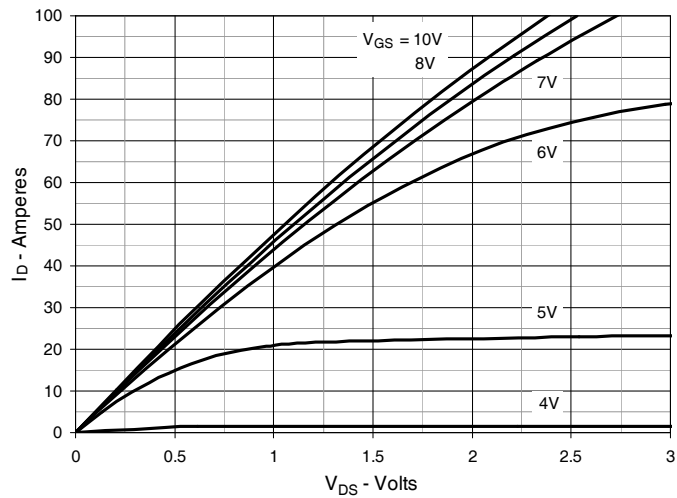

Fig. 4. $R_{DS(on)}$ Normalized to $I_D = 50\text{A}$ Value vs. Junction Temperature

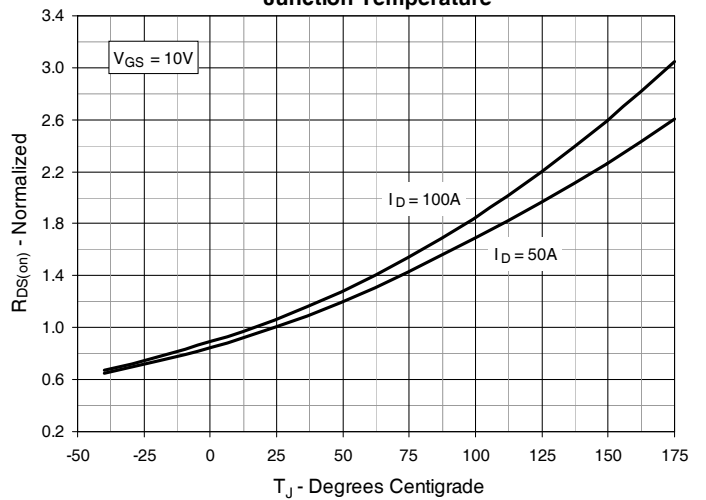

Fig. 5. $R_{DS(on)}$ Normalized to $I_D = 50\text{A}$ Value vs. Drain Current

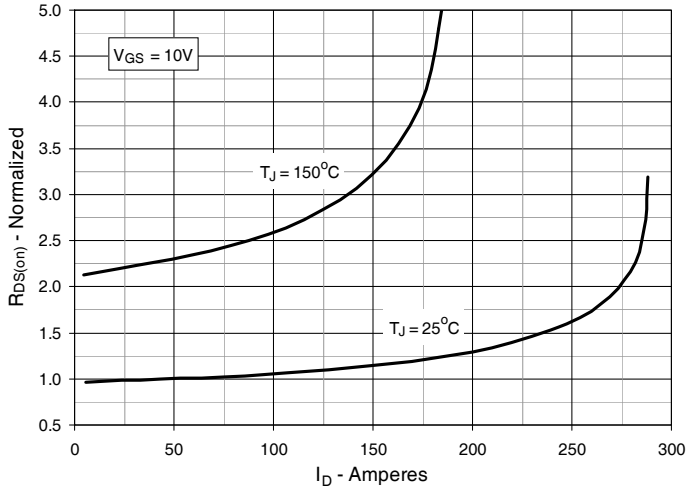

Fig. 6. Normalized Breakdown & Threshold Voltages vs. Junction Temperature

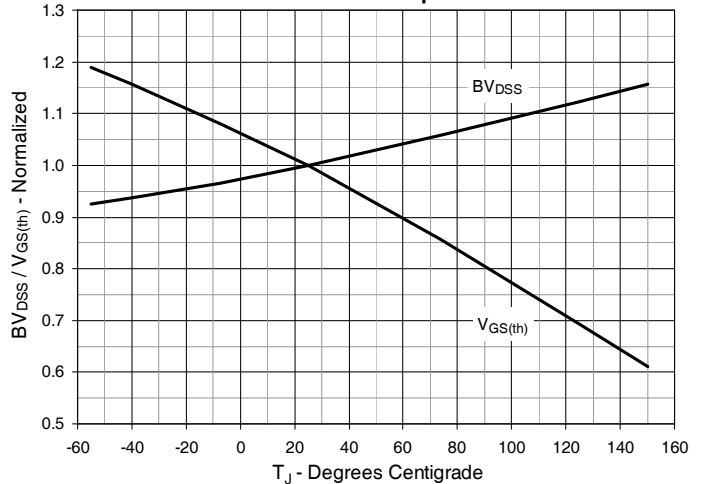

Fig. 7. Maximum Drain Current vs. Case Temperature

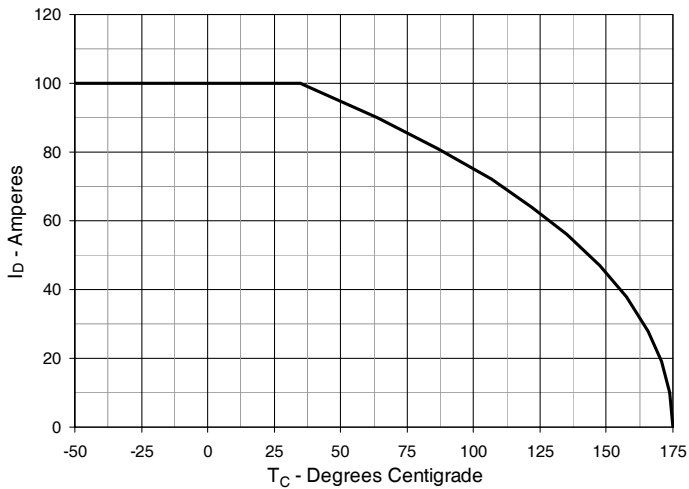

Fig. 8. Input Admittance

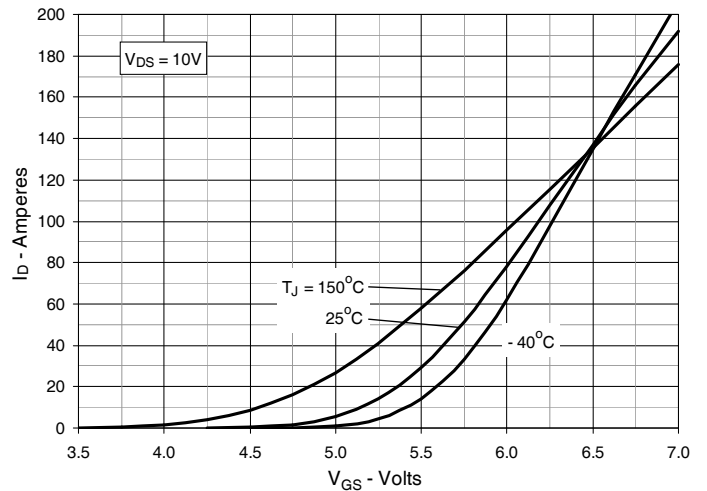

Fig. 9. Transconductance

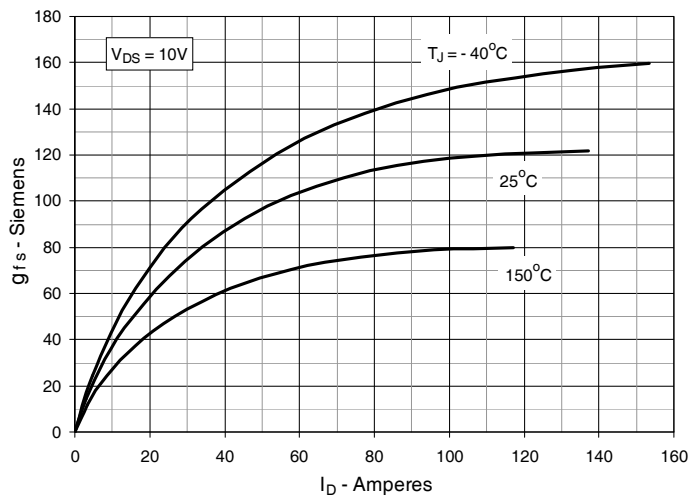

Fig. 10. Forward Voltage Drop of Intrinsic Diode

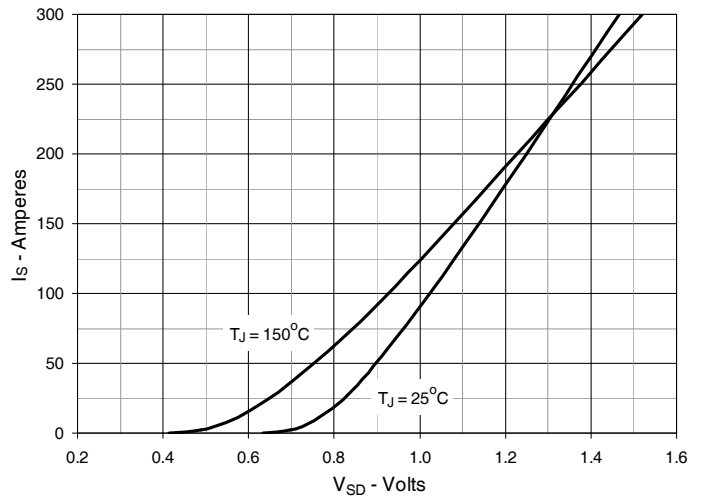

Fig. 11. Gate Charge

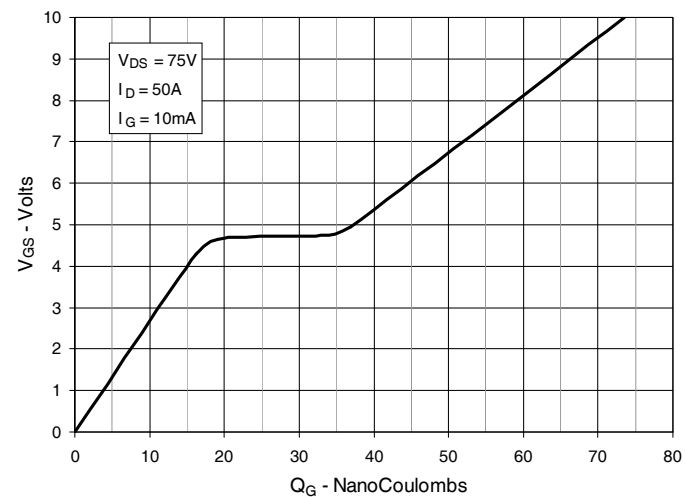

Fig. 12. Capacitance

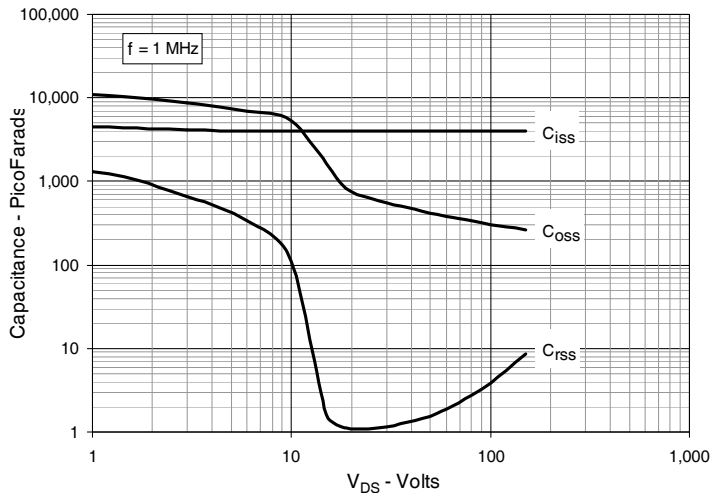

Fig. 13. Output Capacitance Stored Energy

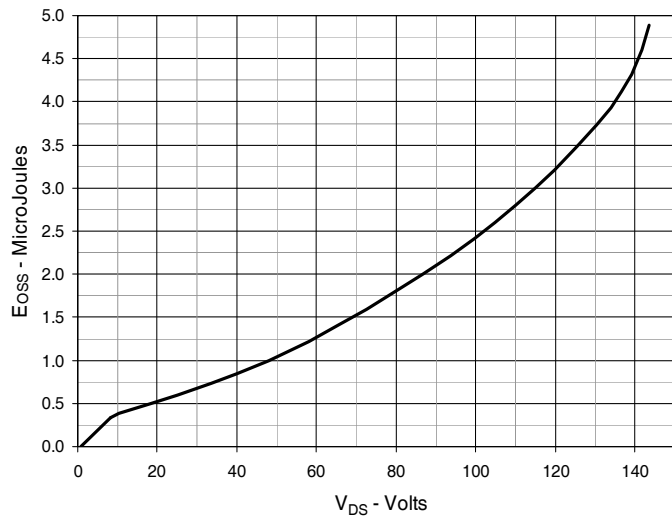

Fig. 14. Forward-Bias Safe Operating Area

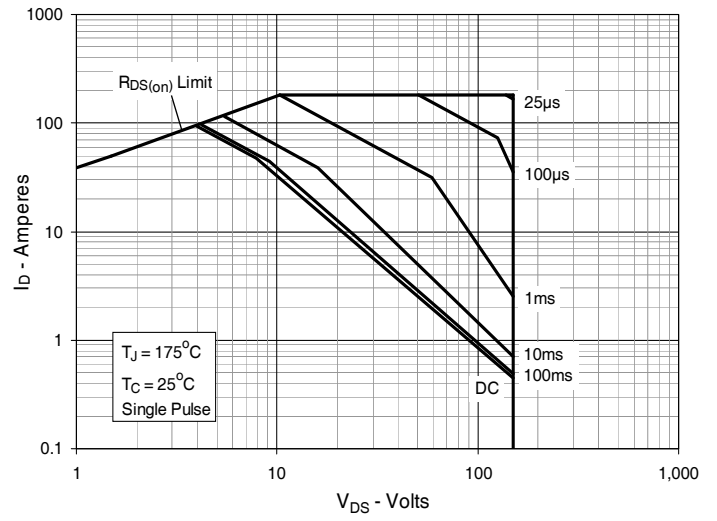
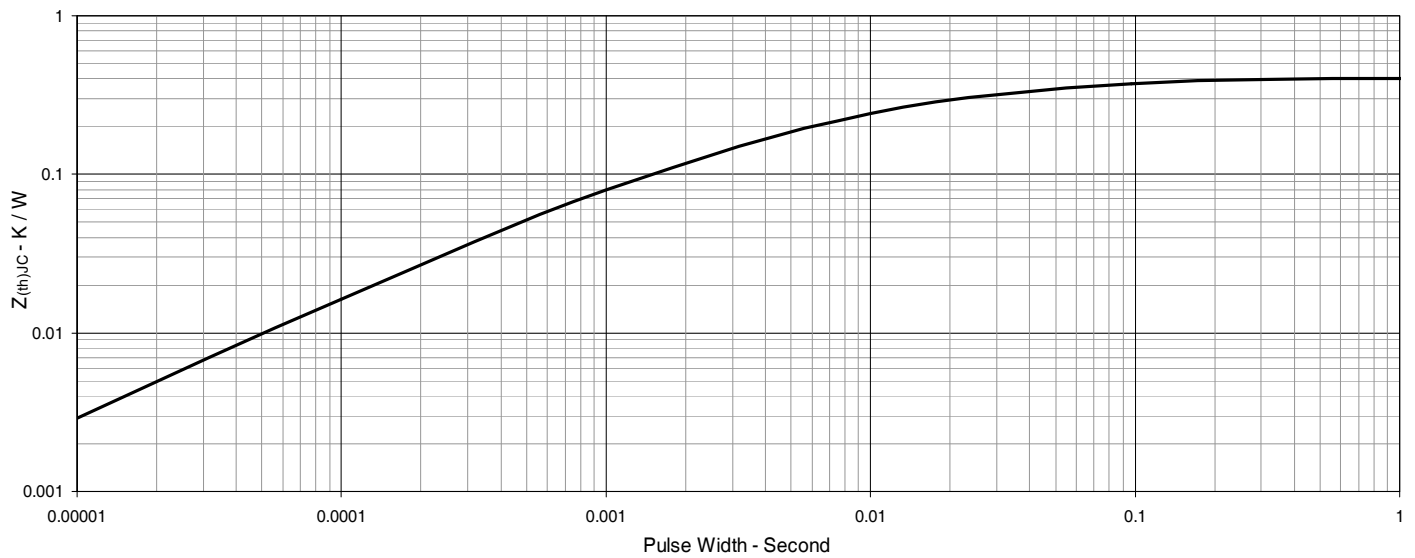
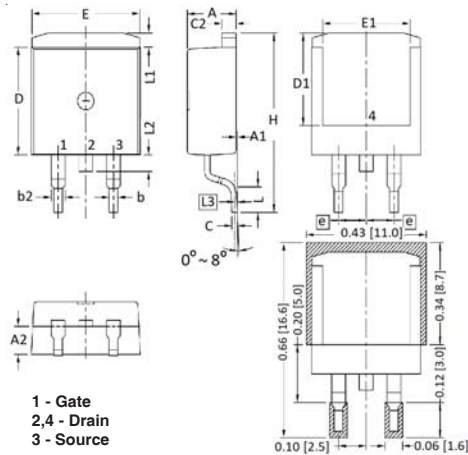

Fig. 15. Maximum Transient Thermal Impedance



TO-263 Outline



SYM	INCHES		MILLIMETER	
	MIN	MAX	MIN	MAX
A	.170	.185	4.30	4.70
A1	.000	.008	0.00	0.20
A2	.091	.098	2.30	2.50
b	.028	.035	0.70	0.90
b2	.046	.060	1.18	1.52
C	.018	.024	0.45	0.60
C2	.049	.060	1.25	1.52
D	.340	.370	8.63	9.40
D1	.300	.327	7.62	8.30
E	.380	.410	9.65	10.41
E1	.270	.330	6.86	8.38
e	.100 BSC		2.54 BSC	
H	.580	.620	14.73	15.75
L	.075	.105	1.91	2.67
L1	.039	.060	1.00	1.52
L2	—	.070	—	1.77
L3	.010 BSC		0.254 BSC	

TO-220 Outline

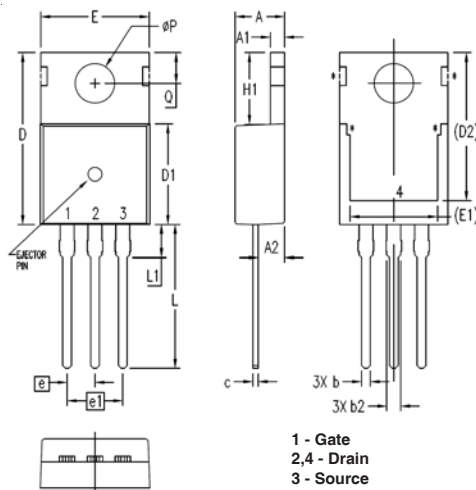

SYM	INCHES		MILLIMETERS	
	MIN	MAX	MIN	MAX
A	.169	.185	4.30	4.70
A1	.047	.055	1.20	1.40
A2	.079	.106	2.00	2.70
b	.024	.039	0.60	1.00
b2	.045	.057	1.15	1.45
c	.014	.026	0.35	0.65
D	.587	.626	14.90	15.90
D1	.335	.370	8.50	9.40
(D2)	.500	.531	12.70	13.50
E	.382	.406	9.70	10.30
(E1)	.283	.323	7.20	8.20
e	.100 BSC		2.54 BSC	
e1	.200 BSC		5.08 BSC	
H1	.244	.268	6.20	6.80
L	.492	.547	12.50	13.90
L1	.110	.154	2.80	3.90
∅P	.134	.150	3.40	3.80
Q	.106	.126	2.70	3.20



Disclaimer Notice - Information furnished is believed to be accurate and reliable. However, users should independently evaluate the suitability of and test each product selected for their own applications. Littelfuse products are not designed for, and may not be used in, all applications. Read complete Disclaimer Notice at www.littelfuse.com/disclaimer-electronics.

X-ON Electronics

Largest Supplier of Electrical and Electronic Components

Click to view similar products for [MOSFET](#) category:

Click to view products by [IXYS](#) manufacturer:

Other Similar products are found below :

[614233C](#) [648584F](#) [IRFD120](#) [JANTX2N5237](#) [FCA20N60_F109](#) [FDZ595PZ](#) [2SK2545\(Q,T\)](#) [405094E](#) [423220D](#) [TPCC8103,L1Q\(CM](#)
[MIC4420CM-TR](#) [VN1206L](#) [SBVS138LT1G](#) [614234A](#) [715780A](#) [NTNS3166NZT5G](#) [SSM6J414TU,LF\(T](#) [751625C](#) [BUK954R8-60E](#)
[NTE6400](#) [SQJ402EP-T1-GE3](#) [2SK2614\(TE16L1,Q\)](#) [2N7002KW-FAI](#) [DMN1017UCP3-7](#) [EFC2J004NUZTDG](#) [ECH8691-TL-W](#)
[FCAB21350L1](#) [P85W28HP2F-7071](#) [DMN1053UCP4-7](#) [NTE221](#) [NTE222](#) [NTE2384](#) [NTE2903](#) [NTE2941](#) [NTE2945](#) [NTE2946](#) [NTE2960](#)
[NTE2967](#) [NTE2969](#) [NTE2976](#) [NTE455](#) [NTE6400A](#) [NTE2910](#) [NTE2916](#) [NTE2956](#) [NTE2911](#) [DMN2080UCB4-7](#) [TK10A80W,S4X\(S](#)
[SSM6P69NU,LF](#) [DMP22D4UFO-7B](#)