

# TrenchT2™ Power MOSFET

# IXTA110N055T2 IXTP110N055T2

$V_{DSS} = 55V$   
 $I_{D25} = 110A$   
 $R_{DS(on)} \leq 6.6m\Omega$

N-Channel Enhancement Mode  
 Avalanche Rated



TO-263 (IXTA)

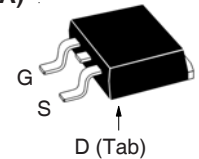

TO-220 (IXTP)

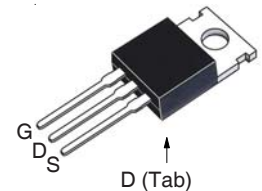

G = Gate    D = Drain  
 S = Source    Tab = Drain

| Symbol        | Test Conditions   | Maximum Ratings    |            |
|---------------|---|--------------------|------------|
| $V_{DSS}$     | $T_J = 25^\circ C$ to $175^\circ C$                       | 55                 | V          |
| $V_{DGR}$     | $T_J = 25^\circ C$ to $175^\circ C$ , $R_{GS} = 1M\Omega$ | 55                 | V          |
| $V_{GSM}$     | Transient   | $\pm 20$           | V          |
| $I_{D25}$     | $T_C = 25^\circ C$  | 110                | A          |
| $I_{DM}$      | $T_C = 25^\circ C$ , Pulse Width Limited by $T_{JM}$      | 300                | A          |
| $I_A$         | $T_C = 25^\circ C$  | 50                 | A          |
| $E_{AS}$      | $T_C = 25^\circ C$  | 400                | mJ         |
| $P_D$         | $T_C = 25^\circ C$  | 180                | W          |
| $T_J$         |   | -55 ... +175       | $^\circ C$ |
| $T_{JM}$      |   | 175                | $^\circ C$ |
| $T_{stg}$     |   | -55 ... +175       | $^\circ C$ |
| $T_L$         | Maximum Lead Temperature for Soldering                    | 300                | $^\circ C$ |
| $T_{SOLD}$    | 1.6 mm (0.062in.) from Case for 10s                       | 260                | $^\circ C$ |
| $F_C$         | Mounting Force (TO-263)                                   | 10..65 / 2.2..14.6 | N/lb       |
| $M_d$         | Mounting Torque (TO-220)                                  | 1.13 / 10          | Nm/lb.in   |
| <b>Weight</b> | TO-263  | 2.5                | g          |
|               | TO-220  | 3.0                | g          |

## Features

- International Standard Packages
- Avalanche Rated
- Low Package Inductance
- Fast Intrinsic Rectifier
- 175°C Operating Temperature
- High Current Handling Capability
- ROHS Compliant
- High Performance Trench Technology for extremely low  $R_{DS(on)}$

## Advantages

- High Power Density
- Easy to Mount
- Space Savings

## Applications

- Automotive Engine Control
- Synchronous Buck Converter (for Notebook SystemPower & General Purpose Point & Load)
- DC/DC Converters
- High Current Switching Applications
- Power Train Management
- Distributed Power Architecture

| Symbol       | Test Conditions<br>( $T_J = 25^\circ C$ Unless Otherwise Specified) | Characteristic Values |      |                          |
|--------------|---|-----------------------|------|--------------------------|
|              |   | Min.                  | Typ. | Max.                     |
| $BV_{DSS}$   | $V_{GS} = 0V$ , $I_D = 250\mu A$                                    | 55                    |      | V                        |
| $V_{GS(th)}$ | $V_{DS} = V_{GS}$ , $I_D = 250\mu A$                                | 2.0                   |      | 4.0 V                    |
| $I_{GSS}$    | $V_{GS} = \pm 20V$ , $V_{DS} = 0V$                                  |                       |      | $\pm 200$ nA             |
| $I_{DSS}$    | $V_{DS} = V_{DSS}$ , $V_{GS} = 0V$<br>$T_J = 150^\circ C$           |                       |      | 2 $\mu A$<br>200 $\mu A$ |
| $R_{DS(on)}$ | $V_{GS} = 10V$ , $I_D = 25A$ , Notes 1 & 2                          | 5.5                   | 6.6  | m $\Omega$               |

| Symbol       | Test Conditions<br>( $T_J = 25^\circ\text{C}$ Unless Otherwise Specified)  | Characteristic Values |      |           |
|--------------|--|-----------------------|------|-----------|
|              |  | Min.                  | Typ. | Max.      |
| $g_{fs}$     | $V_{DS} = 10\text{V}, I_D = 55\text{A}$ , Note 1   | 30                    | 49   | S         |
| $C_{iss}$    | $V_{GS} = 0\text{V}, V_{DS} = 25\text{V}, f = 1\text{MHz}$   |                       | 3060 | pF        |
| $C_{oss}$    |  |                       | 497  | pF        |
| $C_{rss}$    |  |                       | 105  | pF        |
| $t_{d(on)}$  | <b>Resistive Switching Times</b><br>$V_{GS} = 10\text{V}, V_{DS} = 30\text{V}, I_D = 25\text{A}$<br>$R_G = 5\Omega$ (External) |                       | 18   | ns        |
| $t_r$        |  |                       | 25   | ns        |
| $t_{d(off)}$ |  |                       | 40   | ns        |
| $t_f$        |  |                       | 23   | ns        |
| $Q_{g(on)}$  | $V_{GS} = 10\text{V}, V_{DS} = 0.5 \cdot V_{DSS}, I_D = 25\text{A}$  |                       | 57   | nC        |
| $Q_{gs}$     |  |                       | 16   | nC        |
| $Q_{gd}$     |  |                       | 11   | nC        |
| $R_{thJC}$   | TO-220   |                       |      | 0.82 °C/W |
| $R_{thCS}$   |  | 0.50                  |      | °C/W      |

**Source-Drain Diode**

| Symbol   | Test Conditions<br>( $T_J = 25^\circ\text{C}$ Unless Otherwise Specified)                       | Characteristic Values |      |       |
|----------|---|-----------------------|------|-------|
|          |   | Min.                  | Typ. | Max.  |
| $I_s$    | $V_{GS} = 0\text{V}$  |                       |      | 110 A |
| $I_{SM}$ | Repetitive, Pulse Width Limited by $T_{JM}$   |                       |      | 300 A |
| $V_{SD}$ | $I_F = 25\text{A}, V_{GS} = 0\text{V}$ , Note 1   | 0.84                  | 1.00 | V     |
| $t_{rr}$ | $I_F = 50\text{A}, V_{GS} = 0\text{V},$<br>$-di/dt = 100\text{A}/\mu\text{s}, V_R = 27\text{V}$ |                       | 38   | ns    |
| $I_{RM}$ |   |                       | 2.4  | A     |
| $Q_{RM}$ |   |                       | 46   | nC    |

- Notes: 1. Pulse test,  $t \leq 300\mu\text{s}$ ; duty cycle,  $d \leq 2\%$ .  
2. On through-hole packages,  $R_{DS(on)}$  Kelvin test contact location must be 5mm or less from the package body.

**TO-263 Outline**

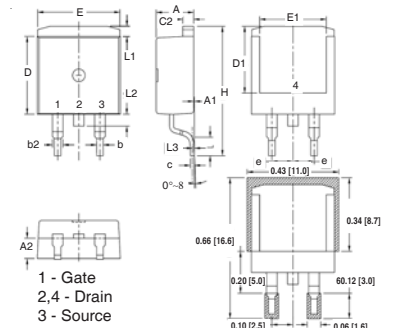

| SYM  | INCHES   |      | MILLIMETER |       |
|------|----------|------|------------|-------|
|      | MIN      | MAX  | MIN        | MAX   |
| A    | .170     | .185 | 4.30       | 4.70  |
| A1   | .000     | .008 | 0.00       | 0.20  |
| A2   | .091     | .098 | 2.30       | 2.50  |
| b    | .028     | .035 | 0.70       | 0.90  |
| b2   | .046     | .060 | 1.18       | 1.52  |
| C    | .018     | .024 | 0.45       | 0.60  |
| C2   | .049     | .060 | 1.25       | 1.52  |
| D    | .340     | .370 | 8.63       | 9.40  |
| D1   | .300     | .327 | 7.62       | 8.30  |
| E    | .380     | .410 | 9.65       | 10.41 |
| E1   | .270     | .330 | 6.86       | 8.38  |
| (e)  | .100 BSC |      | 2.54 BSC   |       |
| H    | .580     | .620 | 14.73      | 15.75 |
| L    | .075     | .105 | 1.91       | 2.67  |
| L1   | .039     | .060 | 1.00       | 1.52  |
| L2   | —        | .070 | —          | 1.77  |
| (L3) | .010 BSC |      | 0.254 BSC  |       |

**TO-220 Outline**

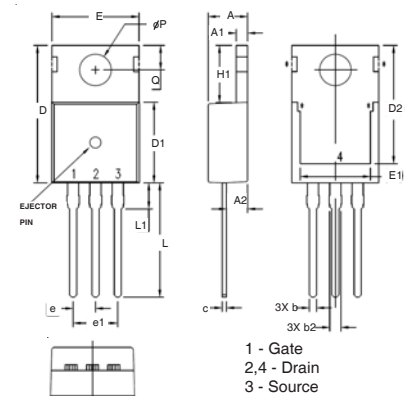

| SYM  | INCHES   |      | MILLIMETERS |       |
|------|----------|------|-------------|-------|
|      | MIN      | MAX  | MIN         | MAX   |
| A    | .169     | .185 | 4.30        | 4.70  |
| A1   | .047     | .055 | 1.20        | 1.40  |
| A2   | .079     | .106 | 2.00        | 2.70  |
| b    | .024     | .039 | 0.60        | 1.00  |
| b2   | .045     | .057 | 1.15        | 1.45  |
| c    | .014     | .026 | 0.35        | 0.65  |
| D    | .587     | .626 | 14.90       | 15.90 |
| D1   | .335     | .370 | 8.50        | 9.40  |
| (D2) | .500     | .531 | 12.70       | 13.50 |
| E    | .382     | .406 | 9.70        | 10.30 |
| (E1) | .283     | .323 | 7.20        | 8.20  |
| e    | .100 BSC |      | 2.54 BSC    |       |
| e1   | .200 BSC |      | 5.08 BSC    |       |
| H1   | .244     | .268 | 6.20        | 6.80  |
| L    | .492     | .547 | 12.50       | 13.90 |
| L1   | .110     | .154 | 2.80        | 3.90  |
| ØP   | .134     | .150 | 3.40        | 3.80  |
| Q    | .106     | .126 | 2.70        | 3.20  |

IXYS Reserves the Right to Change Limits, Test Conditions, and Dimensions.

|  |           |           |           |           |             |             |             |             |             |             |
|--|-----------|-----------|-----------|-----------|-------------|-------------|-------------|-------------|-------------|-------------|
| IXYS MOSFETs and IGBTs are covered by one or more of the following U.S. patents: | 4,835,592 | 4,931,844 | 5,049,961 | 5,237,481 | 6,162,665   | 6,404,065B1 | 6,683,344   | 6,727,585   | 7,005,734B2 | 7,157,338B2 |
|  | 4,860,072 | 5,017,508 | 5,063,307 | 5,381,025 | 6,259,123B1 | 6,534,343   | 6,710,405B2 | 6,759,692   | 7,063,975B2 |             |
|  | 4,881,106 | 5,034,796 | 5,187,117 | 5,486,715 | 6,306,728B1 | 6,583,505   | 6,710,463   | 6,771,478B2 | 7,071,537   |             |

Fig. 1. Output Characteristics @  $T_J = 25^\circ\text{C}$

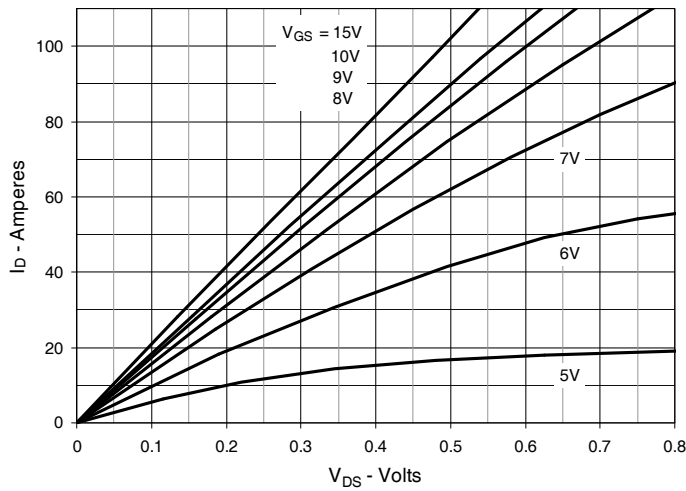

Fig. 2. Extended Output Characteristics @  $T_J = 25^\circ\text{C}$

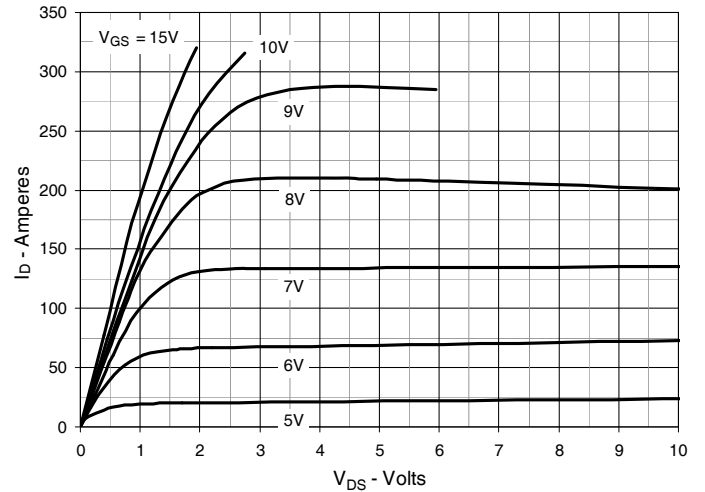

Fig. 3. Output Characteristics @  $T_J = 150^\circ\text{C}$

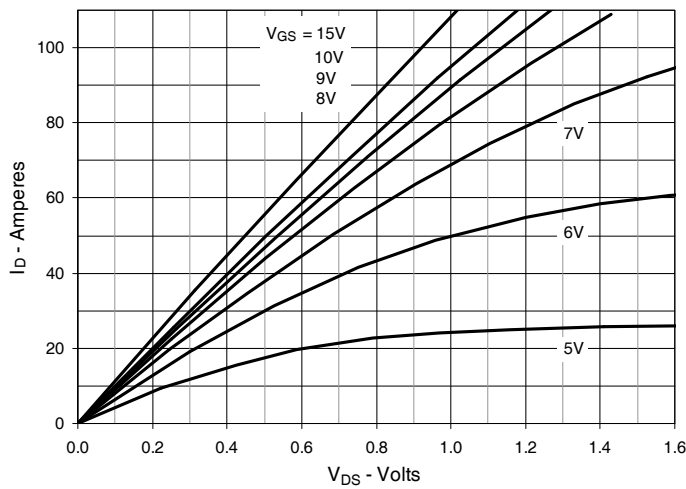

Fig. 4.  $R_{DS(on)}$  Normalized to  $I_D = 55\text{A}$  Value vs. Junction Temperature

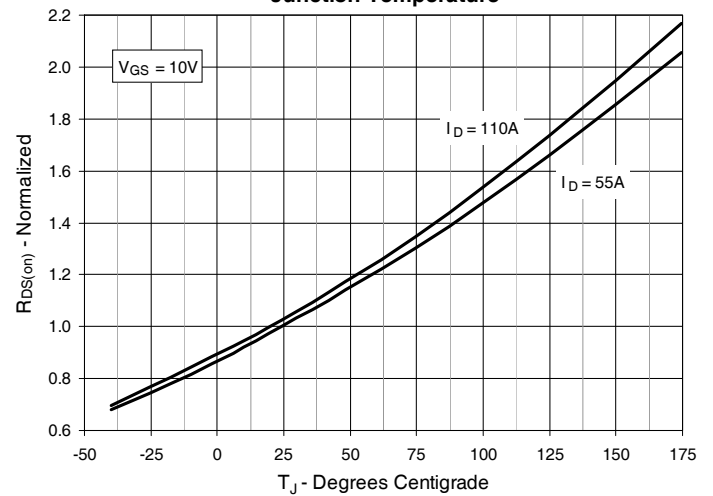

Fig. 5.  $R_{DS(on)}$  Normalized to  $I_D = 55\text{A}$  Value vs. Drain Current

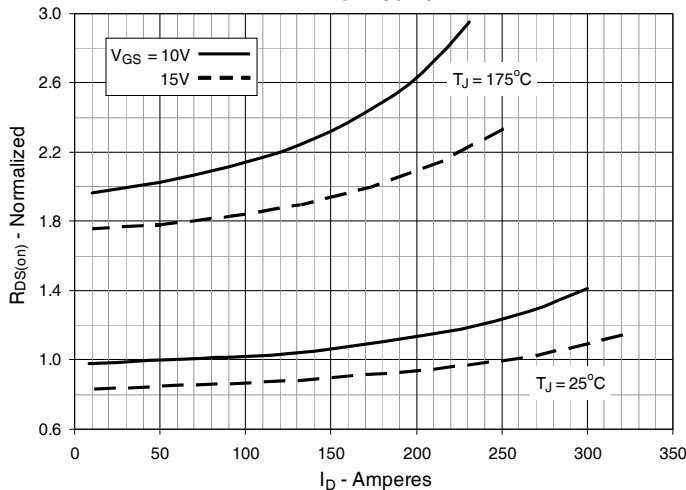

Fig. 6. Drain Current vs. Case Temperature

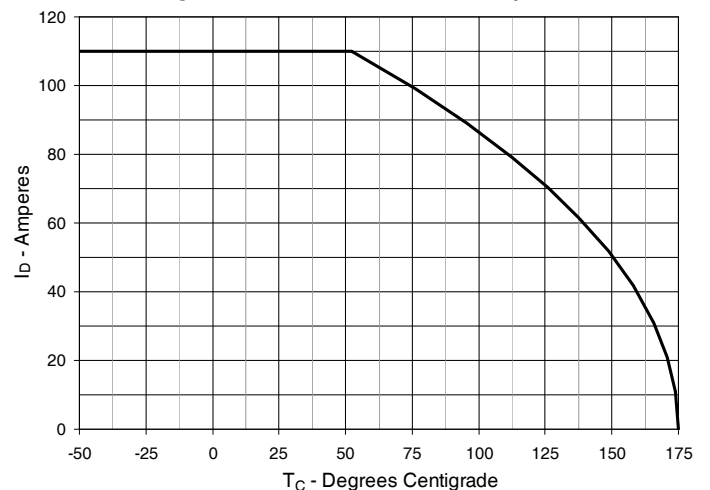

Fig. 7. Input Admittance

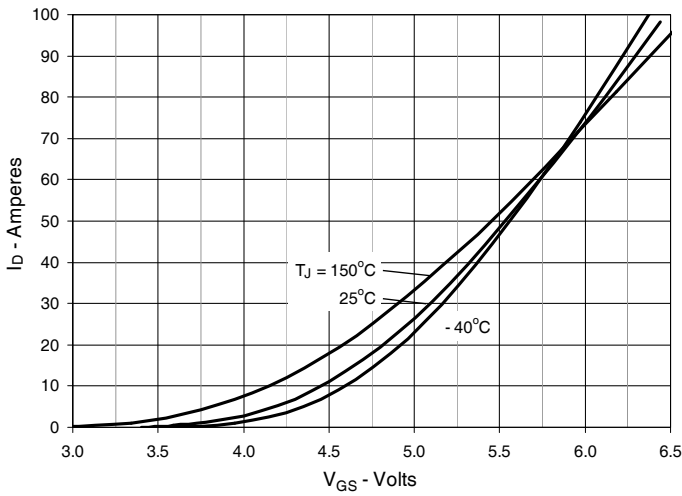

Fig. 8. Transconductance

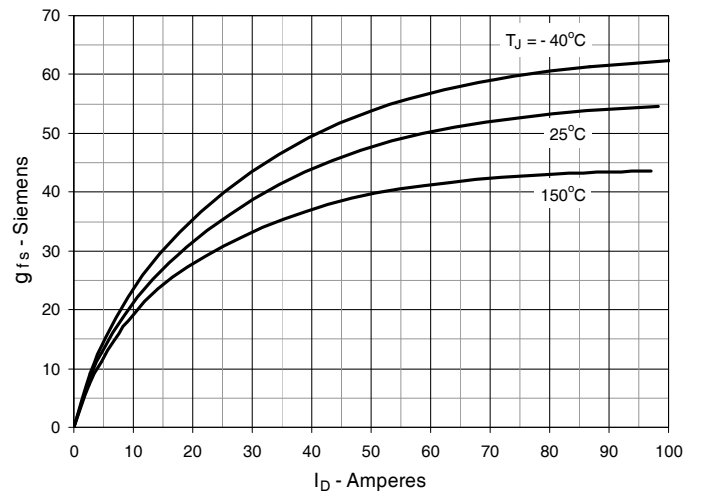

Fig. 9. Forward Voltage Drop of Intrinsic Diode

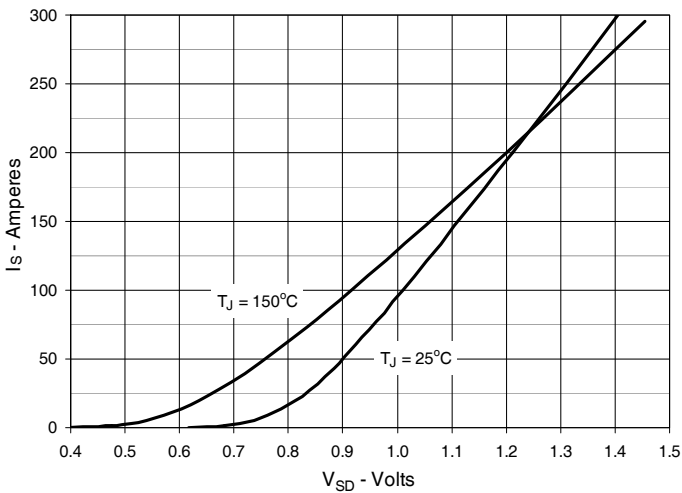

Fig. 10. Gate Charge

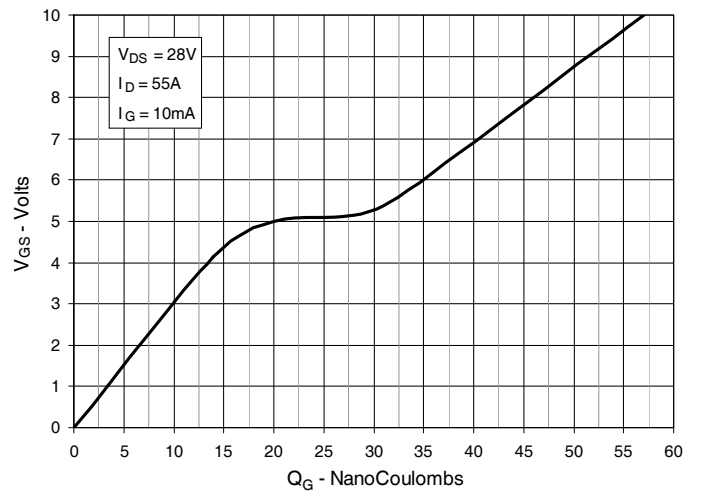

Fig. 11. Capacitance

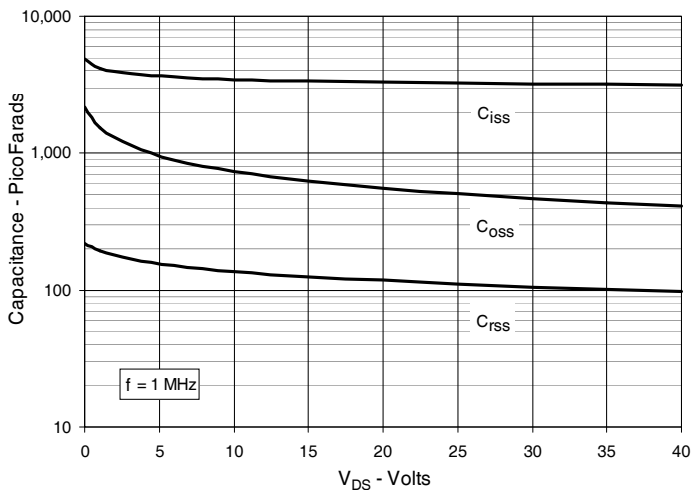
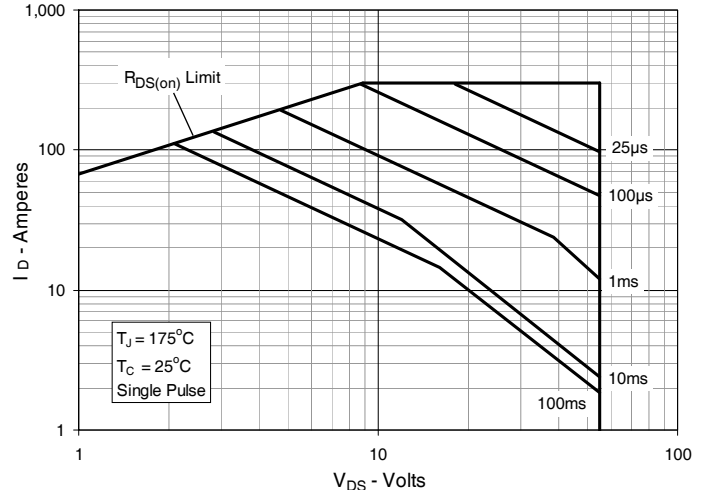
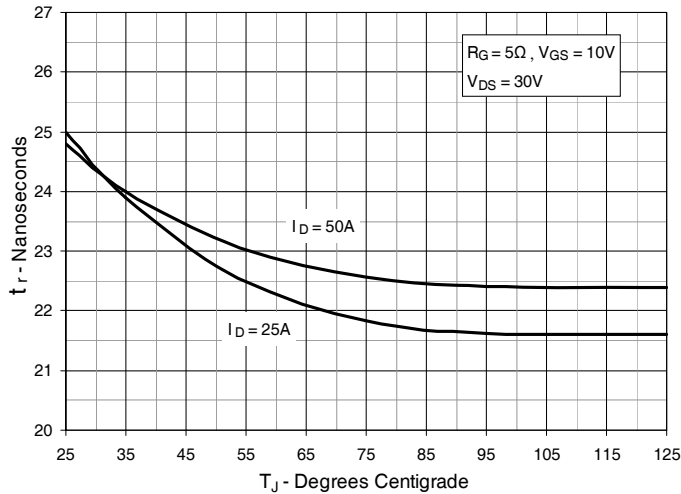

Fig. 12. Forward-Bias Safe Operating Area



**Fig. 13. Resistive Turn-on Rise Time vs. Junction Temperature**



**Fig. 14. Resistive Turn-on Rise Time vs. Drain Current**

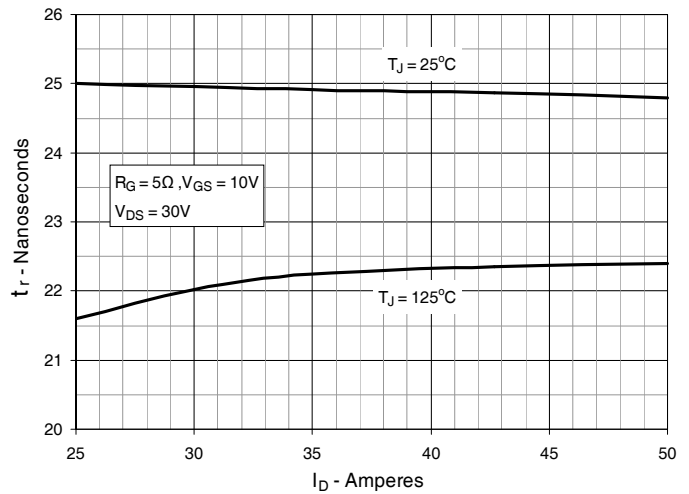

**Fig. 15. Resistive Turn-on Switching Times vs. Gate Resistance**

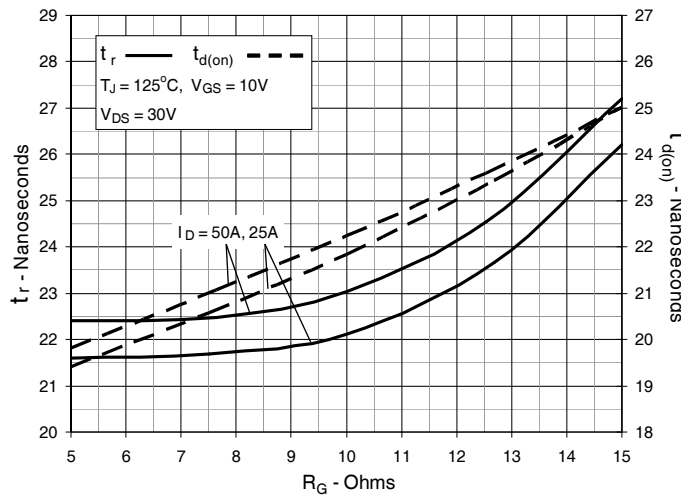

**Fig. 16. Resistive Turn-off Switching Times vs. Junction Temperature**

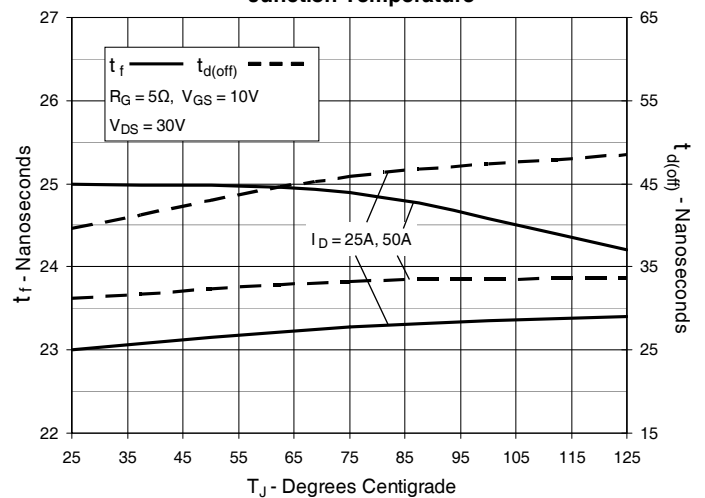

**Fig. 17. Resistive Turn-off Switching Times vs. Drain Current**

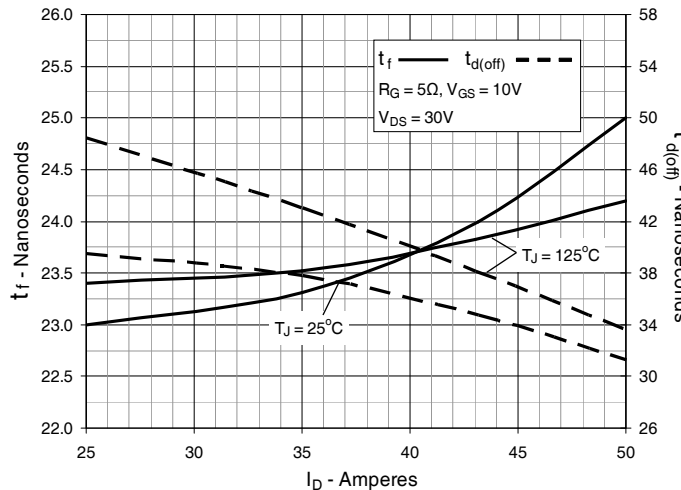

**Fig. 18. Resistive Turn-off Switching Times vs. Gate Resistance**

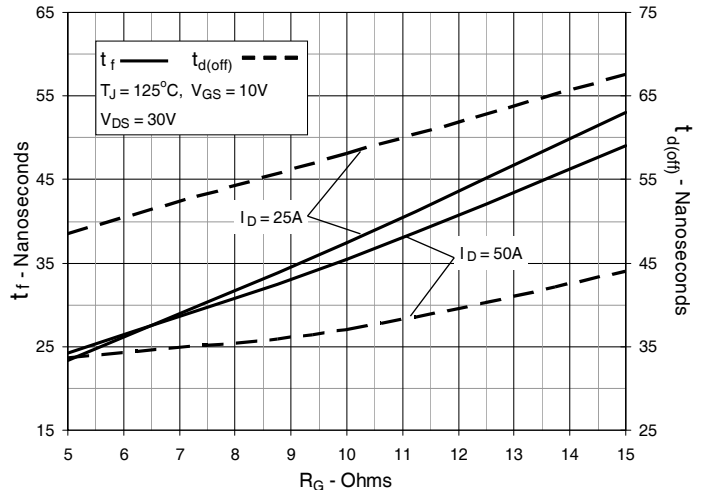

**Fig. 19. Maximum Transient Thermal Impedance**

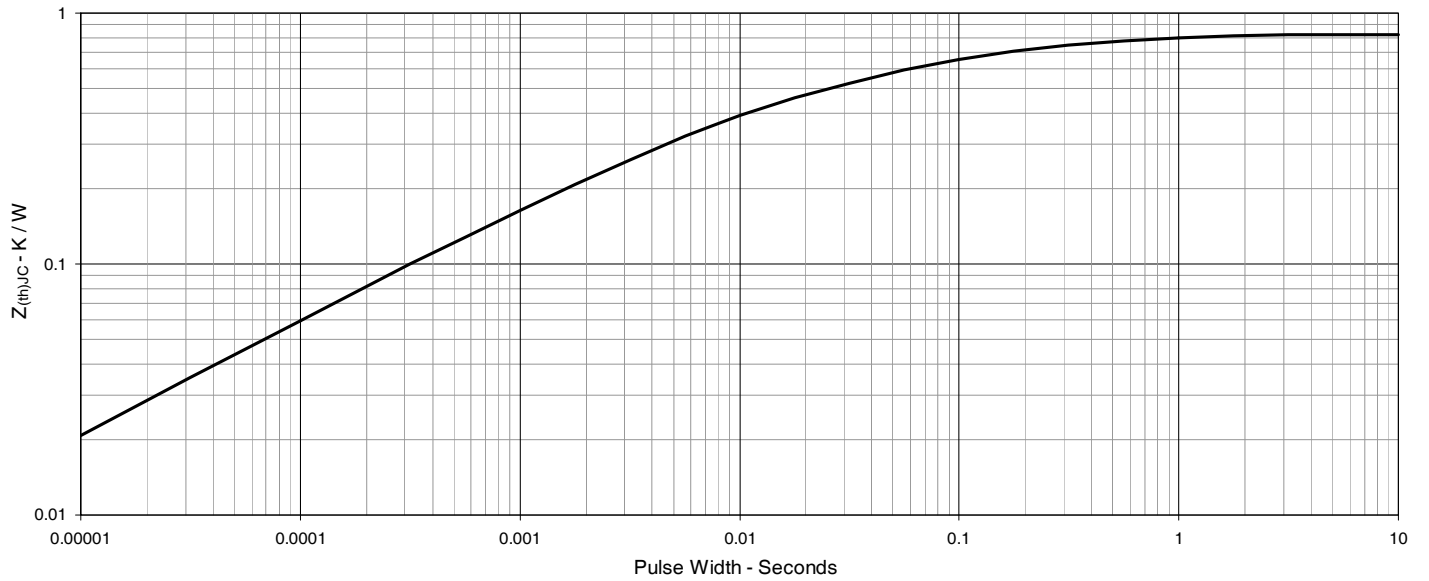



---

Disclaimer Notice - Information furnished is believed to be accurate and reliable. However, users should independently evaluate the suitability of and test each product selected for their own applications. Littelfuse products are not designed for, and may not be used in, all applications. Read complete Disclaimer Notice at [www.littelfuse.com/disclaimer-electronics](http://www.littelfuse.com/disclaimer-electronics).

## X-ON Electronics

Largest Supplier of Electrical and Electronic Components

*Click to view similar products for [MOSFET](#) category:*

*Click to view products by [IXYS](#) manufacturer:*

Other Similar products are found below :

[614233C](#) [648584F](#) [IRFD120](#) [JANTX2N5237](#) [FCA20N60\\_F109](#) [FDZ595PZ](#) [2SK2545\(Q,T\)](#) [405094E](#) [423220D](#) [TPCC8103,L1Q\(CM](#)  
[MIC4420CM-TR](#) [VN1206L](#) [614234A](#) [715780A](#) [NTNS3166NZT5G](#) [SSM6J414TU,LF\(T](#) [751625C](#) [BUK954R8-60E](#) [NTE6400](#) [SQJ402EP-](#)  
[T1-GE3](#) [2SK2614\(TE16L1,Q\)](#) [2N7002KW-FAI](#) [DMN1017UCP3-7](#) [EFC2J004NUZTDG](#) [ECH8691-TL-W](#) [FCAB21350L1](#) [P85W28HP2F-](#)  
[7071](#) [DMN1053UCP4-7](#) [NTE221](#) [NTE222](#) [NTE2384](#) [NTE2903](#) [NTE2941](#) [NTE2945](#) [NTE2946](#) [NTE2960](#) [NTE2967](#) [NTE2969](#) [NTE2976](#)  
[NTE6400A](#) [NTE2910](#) [NTE2916](#) [NTE2956](#) [NTE2911](#) [DMN2080UCB4-7](#) [TK10A80W,S4X\(S](#) [SSM6P69NU,LF](#) [DMP22D4UFO-7B](#)  
[DMN1006UCA6-7](#) [DMN16M9UCA6-7](#)