

PolarHT™ Power MOSFET

IXTK 100N25P
IXTQ 100N25P
IXTT 100N25P

V_{DSS} = 250 V
I_{D25} = 100 A
R_{DS(on)} ≤ 27 mΩ

N-Channel Enhancement Mode
Avalanche Rated



| Symbol | Test Conditions | Maximum Ratings | |
|---------------------|--|-----------------|-----------|
| | | | |
| V _{DSS} | T _J = 25° C to 150° C | 250 | V |
| V _{DGR} | T _J = 25° C to 150° C; R _{GS} = 1 MΩ | 250 | V |
| V _{GSS} | Continuous | ±20 | V |
| V _{GSM} | Transient | ±30 | V |
| I _{D25} | T _C = 25° C | 100 | A |
| I _{D(RMS)} | External lead current limit | 75 | A |
| I _{DM} | T _C = 25° C, pulse width limited by T _{JM} | 250 | A |
| I _{AR} | T _C = 25° C | 60 | A |
| E _{AR} | T _C = 25° C | 60 | mJ |
| E _{AS} | T _C = 25° C | 2.0 | J |
| dv/dt | I _S ≤ I _{DM} , di/dt ≤ 100 A/μs, V _{DD} ≤ V _{DSS} , T _J ≤ 150° C, R _G = 4 Ω | 10 | V/ns |
| P _D | T _C = 25° C | 600 | W |
| T _J | | -55 ... +150 | °C |
| T _{JM} | | 150 | °C |
| T _{stg} | | -55 ... +150 | °C |
| T _L | 1.6 mm (0.062 in.) from case for 10 s | 300 | °C |
| T _{SOLD} | Plastic body for 10 s | 260 | °C |
| M _d | Mounting torque | 1.13/10 | Nm/lb.in. |
| Weight | TO-3P | 5.5 | g |
| | TO-264 | 10 | g |
| | TO-268 | 5.0 | g |

TO-264 (IXTK)

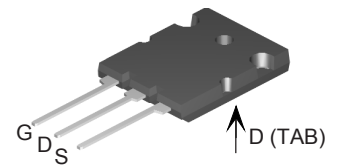

TO-3P (IXTQ)

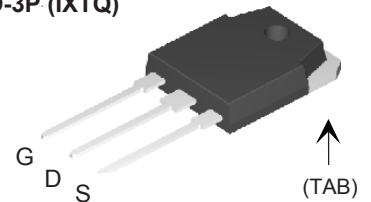

TO-268 (IXTT)

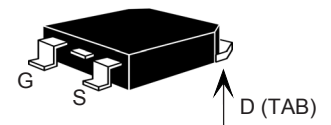

G = Gate D = Drain
S = Source TAB = Drain

Features

- † International standard packages
- † Unclamped Inductive Switching (UIS) rated
- † Low package inductance
- easy to drive and to protect

Advantages

- † Easy to mount
- † Space savings
- † High power density

| Symbol | Test Conditions (T _J = 25° C, unless otherwise specified) | Characteristic Values | | |
|---------------------|---|-----------------------|------|---------|
| | | Min. | Typ. | Max. |
| BV _{DSS} | V _{GS} = 0 V, I _D = 250 μA | 250 | | V |
| V _{GS(th)} | V _{DS} = V _{GS} , I _D = 250 μA | 2.5 | | 5.0 V |
| I _{GSS} | V _{GS} = ±20 V _{DC} , V _{DS} = 0 | | | ±100 nA |
| I _{DSS} | V _{DS} = V _{DSS} V _{GS} = 0 V T _J = 125° C | | | 25 μA |
| | | | | 250 μA |
| R _{DS(on)} | V _{GS} = 10 V, I _D = 0.5 I _{D25} Pulse test, t ≤ 300 μs, duty cycle d ≤ 2 % | | | 27 mΩ |

| Symbol | Test Conditions | Characteristic Values ($T_J = 25^\circ\text{C}$, unless otherwise specified) | | |
|--------------|---|---|------|------------------------|
| | | Min. | Typ. | Max. |
| g_{fs} | $V_{DS} = 10\text{ V}; I_D = 0.5 I_{D25}$, pulse test | 40 | 56 | S |
| C_{iss} | $V_{GS} = 0\text{ V}, V_{DS} = 25\text{ V}, f = 1\text{ MHz}$ | | 6300 | pF |
| C_{oss} | | | 1150 | pF |
| C_{rss} | | | 240 | pF |
| $t_{d(on)}$ | $V_{GS} = 10\text{ V}, V_{DS} = 0.5 V_{DSS}, I_D = I_{D25}$ $R_G = 3.3\ \Omega$ (External) | | 25 | ns |
| t_r | | | 26 | ns |
| $t_{d(off)}$ | | | 100 | ns |
| t_f | | | 28 | ns |
| $Q_{g(on)}$ | $V_{GS} = 10\text{ V}, V_{DS} = 0.5 V_{DSS}, I_D = 0.5 I_{D25}$ | | 185 | nC |
| Q_{gs} | | | 43 | nC |
| Q_{gd} | | | 91 | nC |
| R_{thJC} | | | | 0.21°C/W |
| R_{thCS} | TO-3P | | 0.21 | $^\circ\text{C/W}$ |
| R_{thCS} | TO-264 | | 0.15 | $^\circ\text{C/W}$ |

| Symbol | Test Conditions | Characteristic Values ($T_J = 25^\circ\text{C}$, unless otherwise specified) | | |
|----------|---|---|------|---------------|
| | | Min. | Typ. | Max. |
| I_s | $V_{GS} = 0\text{ V}$ | | | 100 A |
| I_{SM} | Repetitive | | | 250 A |
| V_{SD} | $I_F = I_s, V_{GS} = 0\text{ V}$, Pulse test, $t \leq 300\ \mu\text{s}$, duty cycle $d \leq 2\%$ | | | 1.5 V |
| t_{rr} | $I_F = 25\text{ A}, -di/dt = 100\text{ A}/\mu\text{s}$ $V_R = 100\text{ V}, V_{GS} = 0\text{ V}$ | | 200 | ns |
| Q_{RM} | | | 3.0 | μC |

TO-268 (IXTT) Outline

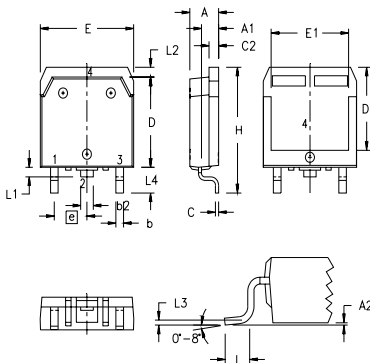

| SYM | INCHES | | MILLIMETERS | |
|-----|----------|------|-------------|-------|
| | MIN | MAX | MIN | MAX |
| A | .193 | .201 | 4.90 | 5.10 |
| A1 | .106 | .114 | 2.70 | 2.90 |
| A2 | .001 | .010 | 0.02 | 0.25 |
| b | .045 | .057 | 1.15 | 1.45 |
| b2 | .075 | .083 | 1.90 | 2.10 |
| C | .016 | .026 | 0.40 | 0.65 |
| C2 | .057 | .063 | 1.45 | 1.60 |
| D | .543 | .551 | 13.80 | 14.00 |
| D1 | .488 | .500 | 12.40 | 12.70 |
| E | .624 | .632 | 15.85 | 16.05 |
| E1 | .524 | .535 | 13.30 | 13.60 |
| e | .215 BSC | | 5.45 BSC | |
| H | .736 | .752 | 18.70 | 19.10 |
| L | .094 | .106 | 2.40 | 2.70 |
| L1 | .047 | .055 | 1.20 | 1.40 |
| L2 | .039 | .045 | 1.00 | 1.15 |
| L3 | .010 BSC | | 0.25 BSC | |
| L4 | .150 | .161 | 3.80 | 4.10 |

TO-3P (IXTQ) Outline

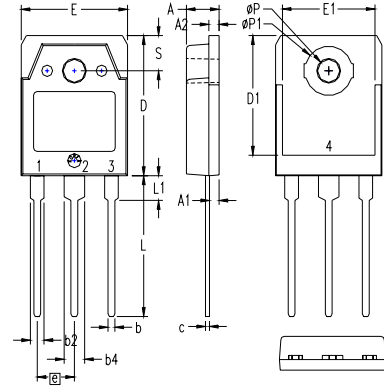

- 1 - GATE
- 2 - DRAIN (COLLECTOR)
- 3 - SOURCE (EMITTER)
- 4 - DRAIN (COLLECTOR)

| SYM | INCHES | | MILLIMETERS | |
|-----------|----------|------|-------------|-------|
| | MIN | MAX | MIN | MAX |
| A | .185 | .193 | 4.70 | 4.90 |
| A1 | .051 | .059 | 1.30 | 1.50 |
| A2 | .057 | .065 | 1.45 | 1.65 |
| b | .035 | .045 | 0.90 | 1.15 |
| b2 | .075 | .087 | 1.90 | 2.20 |
| b4 | .114 | .126 | 2.90 | 3.20 |
| c | .022 | .031 | 0.55 | 0.80 |
| D | .780 | .799 | 19.80 | 20.30 |
| D1 | .665 | .677 | 16.90 | 17.20 |
| E | .610 | .622 | 15.50 | 15.80 |
| E1 | .531 | .539 | 13.50 | 13.70 |
| e | .215 BSC | | 5.45 BSC | |
| L | .779 | .795 | 19.80 | 20.20 |
| L1 | .134 | .142 | 3.40 | 3.60 |
| ϕP | .126 | .134 | 3.20 | 3.40 |
| $\phi P1$ | .272 | .280 | 6.90 | 7.10 |
| S | .193 | .201 | 4.90 | 5.10 |

TO-264 (IXTK) Outline

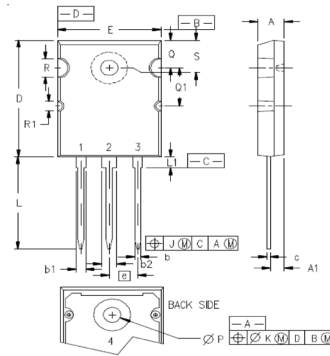

- 1 - GATE
- 2, 4 - DRAIN (COLLECTOR)
- 3 - SOURCE (EMITTER)

| SYM | INCHES | | MILLIMETERS | |
|-----------|----------|-------|-------------|-------|
| | MIN | MAX | MIN | MAX |
| A | .185 | .209 | 4.70 | 5.31 |
| A1 | .102 | .118 | 2.59 | 3.00 |
| b | .037 | .055 | 0.94 | 1.40 |
| b1 | .087 | .102 | 2.21 | 2.59 |
| b2 | .110 | .126 | 2.79 | 3.20 |
| c | .017 | .029 | 0.43 | 0.74 |
| D | 1.007 | 1.047 | 25.58 | 26.59 |
| E | .760 | .799 | 19.30 | 20.29 |
| e | .215 BSC | | 5.46 BSC | |
| J | .000 | .010 | 0.00 | 0.25 |
| K | .000 | .010 | 0.00 | 0.25 |
| L | .779 | .842 | 19.79 | 21.39 |
| L1 | .087 | .102 | 2.21 | 2.59 |
| ϕP | .122 | .138 | 3.10 | 3.51 |
| Q | .240 | .256 | 6.10 | 6.50 |
| Q1 | .330 | .346 | 8.38 | 8.79 |
| ϕR | .155 | .187 | 3.94 | 4.75 |
| $\phi R1$ | .085 | .093 | 2.16 | 2.36 |
| S | .243 | .253 | 6.17 | 6.43 |

IXYS reserves the right to change limits, test conditions, and dimensions.

IXYS MOSFETs and IGBTs are covered by 4,835,592 4,931,844 5,049,961 5,237,481 6,162,665 6,404,065 B1 6,683,344 6,727,585
one or more of the following U.S. patents: 4,850,072 5,017,508 5,063,307 5,381,025 6,259,123 B1 6,534,343 6,710,405 B2 6,759,692
4,881,106 5,034,796 5,187,117 5,486,715 6,306,728 B1 6,583,505 6,710,463 6,771,478 B2

**Fig. 1. Output Characteristics
@ 25°C**

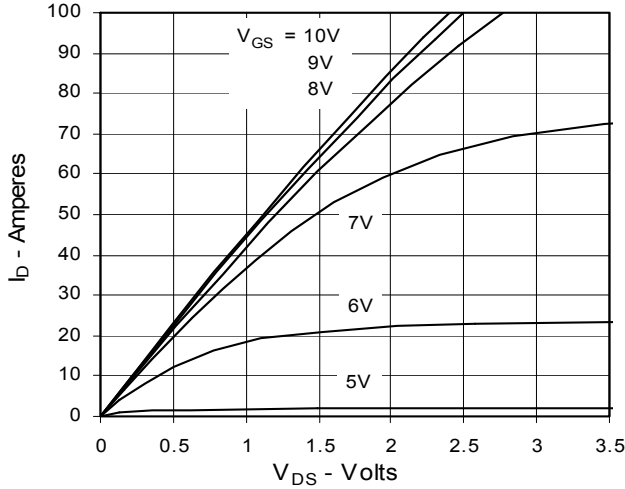

**Fig. 2. Extended Output Characteristics
@ 25°C**

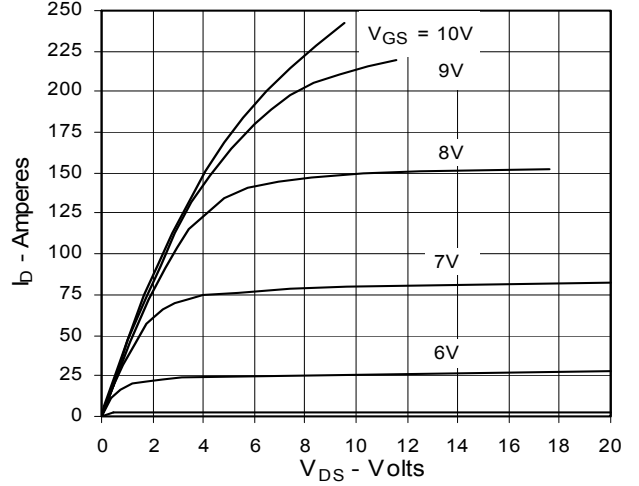

**Fig. 3. Output Characteristics
@ 125°C**

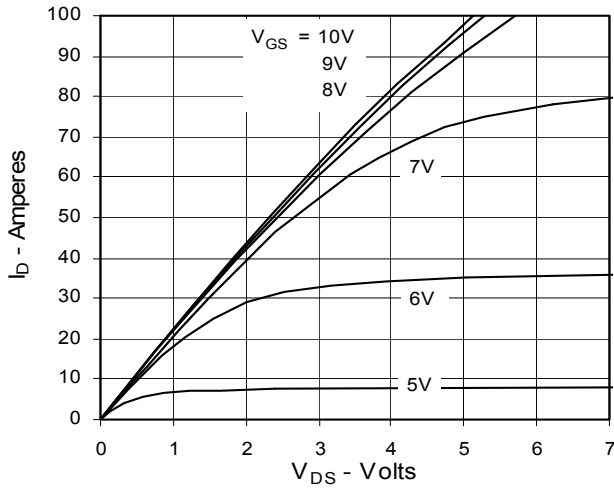

**Fig. 4. $R_{DS(on)}$ Normalized to 0.5 I_{D25}
Value vs. Junction Temperature**

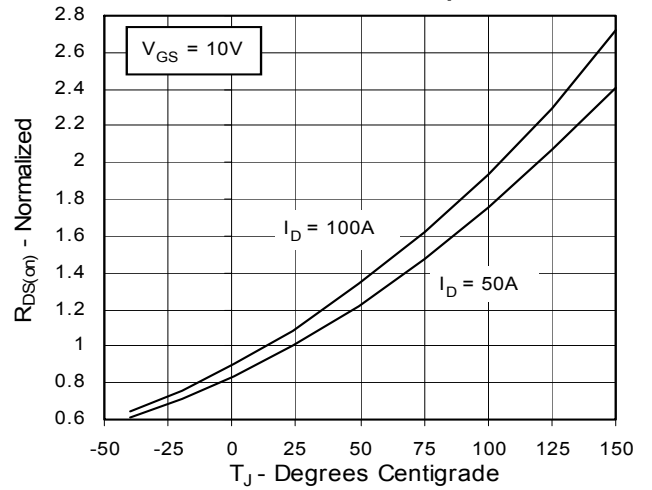

**Fig. 5. $R_{DS(on)}$ Normalized to
0.5 I_{D25} Value vs. I_D**

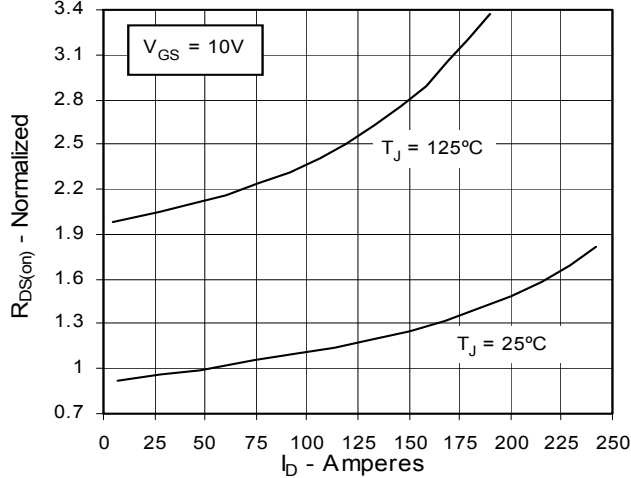

**Fig. 6. Drain Current vs. Case
Temperature**

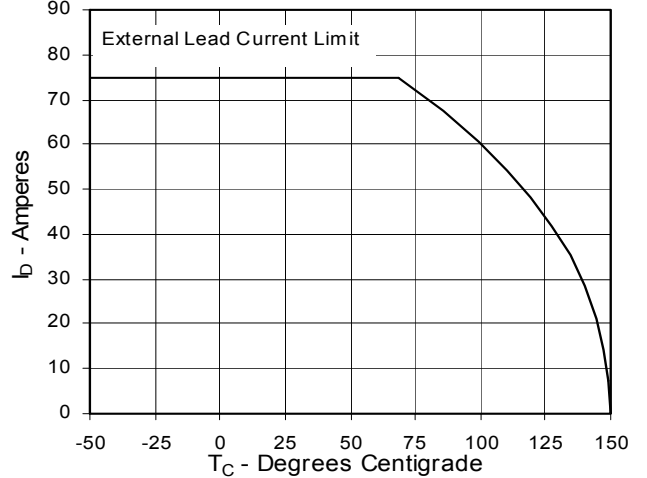

Fig. 7. Input Admittance

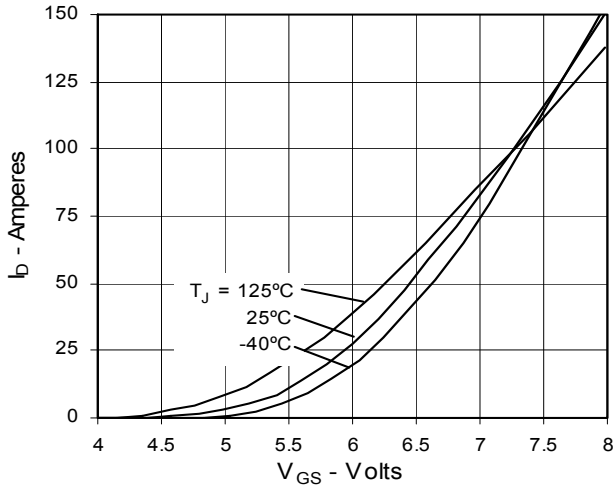

Fig. 8. Transconductance

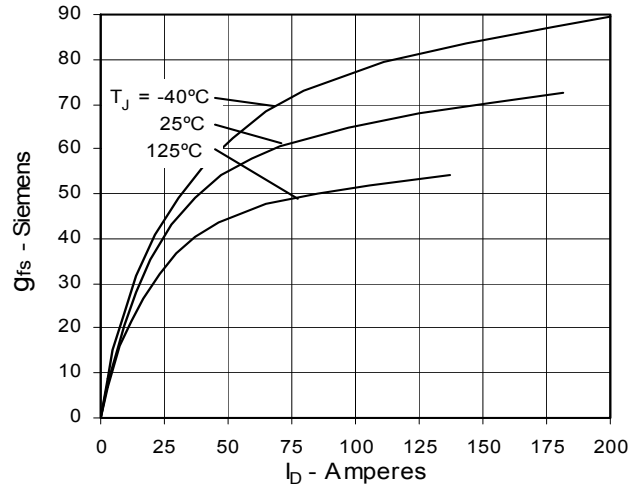

Fig. 9. Source Current vs. Source-To-Drain Voltage

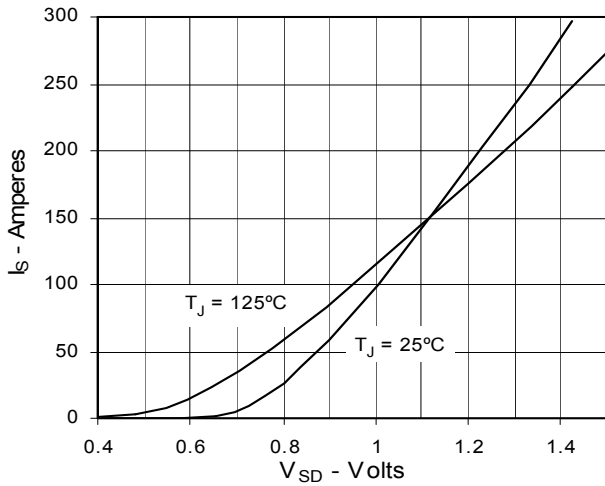

Fig. 10. Gate Charge

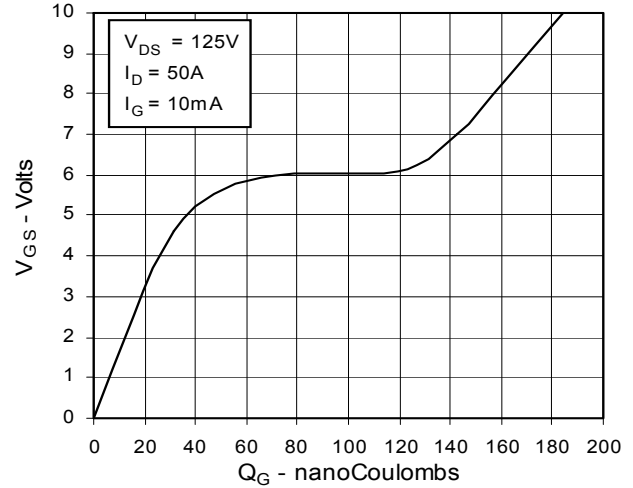

Fig. 11. Capacitance

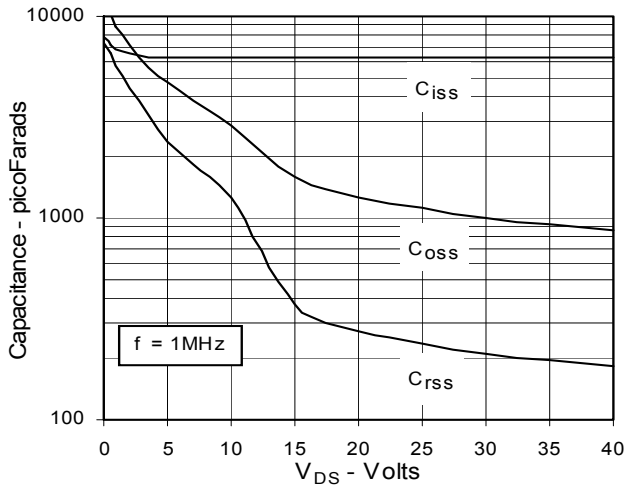

Fig. 12. Forward-Bias Safe Operating Area

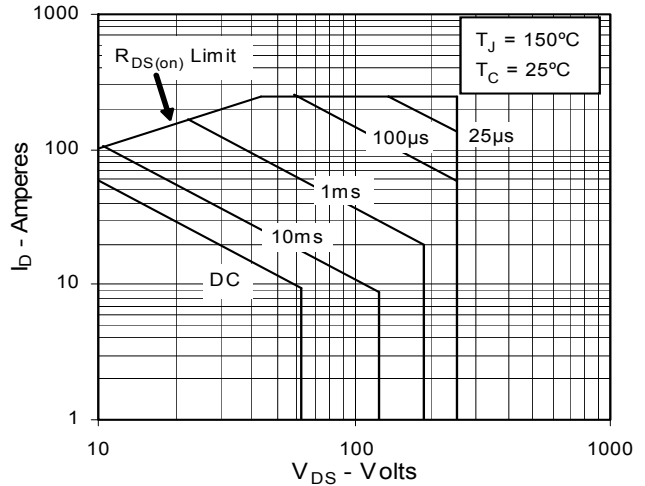
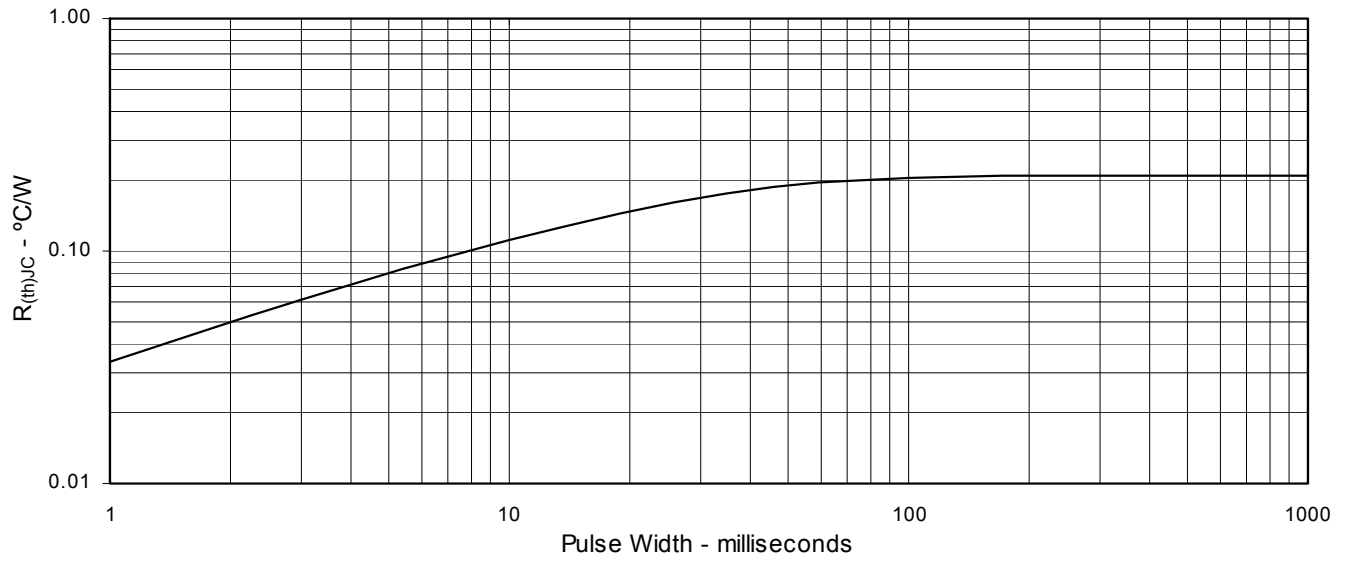

Fig. 13. Maximum Transient Thermal Resistance





Disclaimer Notice - Information furnished is believed to be accurate and reliable. However, users should independently evaluate the suitability of and test each product selected for their own applications. Littelfuse products are not designed for, and may not be used in, all applications. Read complete Disclaimer Notice at www.littelfuse.com/disclaimer-electronics.

X-ON Electronics

Largest Supplier of Electrical and Electronic Components

Click to view similar products for [MOSFET](#) category:

Click to view products by [IXYS](#) manufacturer:

Other Similar products are found below :

[614233C](#) [648584F](#) [IRFD120](#) [JANTX2N5237](#) [FCA20N60_F109](#) [FDZ595PZ](#) [2SK2545\(Q,T\)](#) [405094E](#) [423220D](#) [TPCC8103,L1Q\(CM](#)
[MIC4420CM-TR](#) [VN1206L](#) [614234A](#) [715780A](#) [NTNS3166NZT5G](#) [SSM6J414TU,LF\(T](#) [751625C](#) [BUK954R8-60E](#) [NTE6400](#) [SQJ402EP-](#)
[T1-GE3](#) [2SK2614\(TE16L1,Q\)](#) [2N7002KW-FAI](#) [DMN1017UCP3-7](#) [EFC2J004NUZTDG](#) [ECH8691-TL-W](#) [FCAB21350L1](#) [P85W28HP2F-](#)
[7071](#) [DMN1053UCP4-7](#) [NTE221](#) [NTE222](#) [NTE2384](#) [NTE2903](#) [NTE2941](#) [NTE2945](#) [NTE2946](#) [NTE2960](#) [NTE2967](#) [NTE2969](#) [NTE2976](#)
[NTE6400A](#) [NTE2910](#) [NTE2916](#) [NTE2956](#) [NTE2911](#) [DMN2080UCB4-7](#) [TK10A80W,S4X\(S](#) [SSM6P69NU,LF](#) [DMP22D4UFO-7B](#)
[DMN1006UCA6-7](#) [DMN16M9UCA6-7](#)