

1200V XPT™ IGBTs GenX3™

IXYK120N120C3 IXYX120N120C3

High-Speed IGBTs
for 20-50 kHz Switching

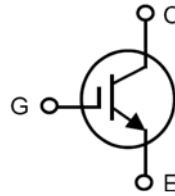

$$V_{CES} = 1200V$$

$$I_{C110} = 120A$$

$$V_{CE(sat)} \leq 3.20V$$

$$t_{fi(typ)} = 96ns$$

Symbol	Test Conditions	Maximum Ratings	
V_{CES}	$T_J = 25^\circ C$ to $175^\circ C$	1200	V
V_{CGR}	$T_J = 25^\circ C$ to $175^\circ C$, $R_{GE} = 1M\Omega$	1200	V
V_{GES}	Continuous	± 20	V
V_{GEM}	Transient	± 30	V
I_{C25}	$T_C = 25^\circ C$ (Chip Capability)	240	A
I_{LRMS}	Terminal Current Limit	160	A
I_{C110}	$T_C = 110^\circ C$	120	A
I_{CM}	$T_C = 25^\circ C$, 1ms	700	A
I_A	$T_C = 25^\circ C$	60	A
E_{AS}	$T_C = 25^\circ C$	2	J
SSOA (RBSOA)	$V_{GE} = 15V$, $T_{VJ} = 150^\circ C$, $R_G = 1\Omega$ Clamped Inductive Load	$I_{CM} = 240$ $V_{CE} \leq V_{CES}$	A
P_C	$T_C = 25^\circ C$	1500	W
T_J		-55 ... +175	$^\circ C$
T_{JM}		175	$^\circ C$
T_{stg}		-55 ... +175	$^\circ C$
T_L	Maximum Lead Temperature for Soldering	300	$^\circ C$
T_{SOLD}	1.6 mm (0.062in.) from Case for 10s	260	$^\circ C$
M_d	Mounting Torque (TO-264)	1.13/10	Nm/lb.in
F_C	Mounting Force (PLUS247)	20..120 / 4.5..27	N/lb
Weight	TO-264	10	g
	PLUS247	6	g

TO-264 (IXYK)

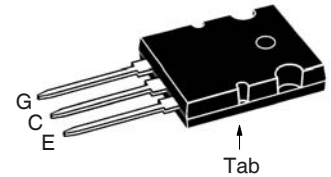

PLUS247 (IXYX)

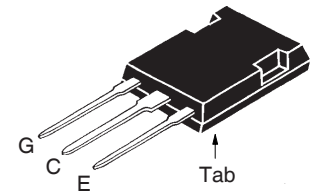

G = Gate E = Emitter
C = Collector Tab = Collector

Features

- Optimized for Low Switching Losses
- Square RBSOA
- International Standard Packages
- Positive Thermal Coefficient of $V_{ce(sat)}$
- Avalanche Rated
- High Current Handling Capability

Advantages

- High Power Density
- Low Gate Drive Requirement

Applications

- High Frequency Power Inverters
- UPS
- Motor Drives
- SMPS
- PFC Circuits
- Battery Chargers
- Welding Machines
- Lamp Ballasts

Symbol	Test Conditions ($T_J = 25^\circ C$, Unless Otherwise Specified)	Characteristic Values		
		Min.	Typ.	Max.
BV_{CES}	$I_C = 250\mu A$, $V_{GE} = 0V$	1200		V
$V_{GE(th)}$	$I_C = 500\mu A$, $V_{CE} = V_{GE}$	3.0		V
I_{CES}	$V_{CE} = V_{CES}$, $V_{GE} = 0V$ $T_J = 150^\circ C$			25 μA 1.5 mA
I_{GES}	$V_{CE} = 0V$, $V_{GE} = \pm 20V$			± 100 nA
$V_{CE(sat)}$	$I_C = I_{C110}$, $V_{GE} = 15V$, Note 1 $T_J = 150^\circ C$	2.55		3.20 V
		3.40		V

Symbol Test Conditions ($T_J = 25^\circ\text{C}$ Unless Otherwise Specified)		Characteristic Values		
		Min.	Typ.	Max.
g_{fs}	$I_C = 60\text{A}, V_{CE} = 10\text{V}$, Note 1	40	68	S
C_{ies}	$V_{CE} = 25\text{V}, V_{GE} = 0\text{V}, f = 1\text{MHz}$		9850	pF
C_{oes}			580	pF
C_{res}			218	pF
$Q_{g(on)}$	$I_C = I_{C110}, V_{GE} = 15\text{V}, V_{CE} = 0.5 \cdot V_{CES}$		412	nC
Q_{ge}			73	nC
Q_{gc}			180	nC
$t_{d(on)}$	Inductive load, $T_J = 25^\circ\text{C}$ $I_C = 100\text{A}, V_{GE} = 15\text{V}$ $V_{CE} = 0.5 \cdot V_{CES}, R_G = 1\Omega$ Note 2		35	ns
t_{ri}			77	ns
E_{on}			6.75	mJ
$t_{d(off)}$			176	ns
t_{fi}			96	ns
E_{off}		5.10	mJ	
$t_{d(on)}$	Inductive load, $T_J = 150^\circ\text{C}$ $I_C = 100\text{A}, V_{GE} = 15\text{V}$ $V_{CE} = 0.5 \cdot V_{CES}, R_G = 1\Omega$ Note 2		33	ns
t_{ri}			72	ns
E_{on}			10.30	mJ
$t_{d(off)}$			226	ns
t_{fi}			120	ns
E_{off}		7.20	mJ	
R_{thJC}			0.10	$^\circ\text{C/W}$
R_{thCS}		0.15		$^\circ\text{C/W}$

Notes:

1. Pulse test, $t \leq 300\mu\text{s}$, duty cycle, $d \leq 2\%$.
2. Switching times & energy losses may increase for higher V_{CE} (clamp), T_J or R_G .

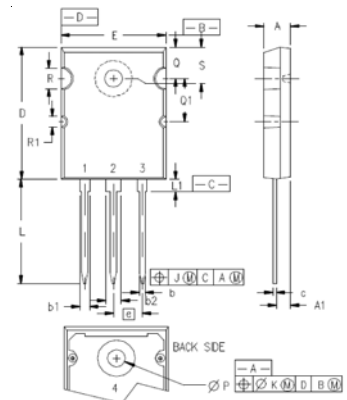
TO-264 Outline

Terminals: 1 = Gate
2,4 = Collector
3 = Emitter

SYM	INCHES		MILLIMETERS	
	MIN	MAX	MIN	MAX
A	.185	.209	4.70	5.31
A1	.102	.118	2.59	3.00
b	.037	.055	0.94	1.40
b1	.087	.102	2.21	2.59
b2	.110	.126	2.79	3.20
c	.017	.029	0.43	0.74
D	1.007	1.047	25.58	26.59
E	.760	.799	19.30	20.29
e	.215 BSC		5.46 BSC	
J	.000	.010	0.00	0.25
K	.000	.010	0.00	0.25
L	.779	.842	19.79	21.39
L1	.087	.102	2.21	2.59
ØP	.122	.138	3.10	3.51
Q	.240	.256	6.10	6.50
Q1	.330	.346	8.38	8.79
ØR	.155	.187	3.94	4.75
ØR1	.085	.093	2.16	2.36
S	.243	.253	6.17	6.43

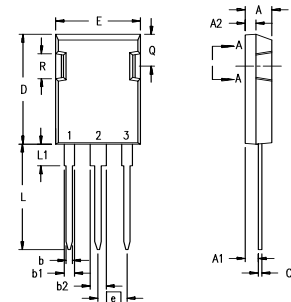
PLUS247™ Outline

Terminals: 1 - Gate
2 - Collector
3 - Emitter

Dim.	Millimeter		Inches	
	Min.	Max.	Min.	Max.
A	4.83	5.21	.190	.205
A ₁	2.29	2.54	.090	.100
A ₂	1.91	2.16	.075	.085
b	1.14	1.40	.045	.055
b ₁	1.91	2.13	.075	.084
b ₂	2.92	3.12	.115	.123
C	0.61	0.80	.024	.031
D	20.80	21.34	.819	.840
E	15.75	16.13	.620	.635
e	5.45 BSC		.215 BSC	
L	19.81	20.32	.780	.800
L1	3.81	4.32	.150	.170
Q	5.59	6.20	.220	0.244
R	4.32	4.83	.170	.190

IXYS Reserves the Right to Change Limits, Test Conditions, and Dimensions.

IXYS MOSFETs and IGBTs are covered 4,835,592 4,931,844 5,049,961 5,237,481 6,162,665 6,404,065 B1 6,683,344 6,727,585 7,005,734 B2 7,157,338B2
by one or more of the following U.S. patents: 4,860,072 5,017,508 5,063,307 5,381,025 6,259,123 B1 6,534,343 6,710,405 B2 6,759,692 7,063,975 B2
4,881,106 5,034,796 5,187,117 5,486,715 6,306,728 B1 6,583,505 6,710,463 6,771,478 B2 7,071,537

Fig. 1. Output Characteristics @ $T_J = 25^\circ\text{C}$

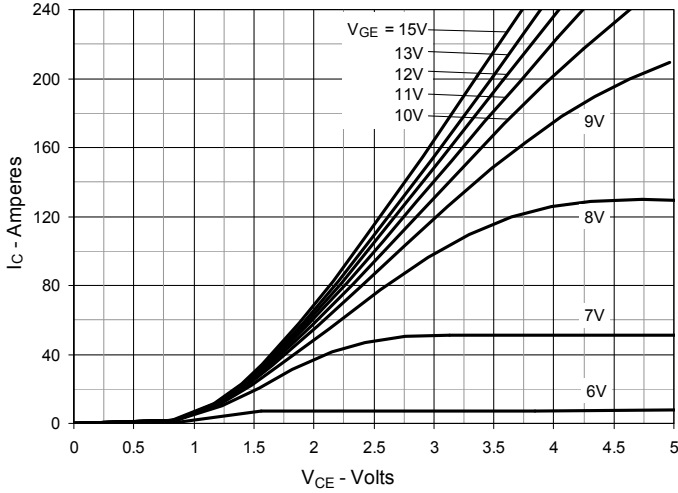

Fig. 2. Extended Output Characteristics @ $T_J = 25^\circ\text{C}$

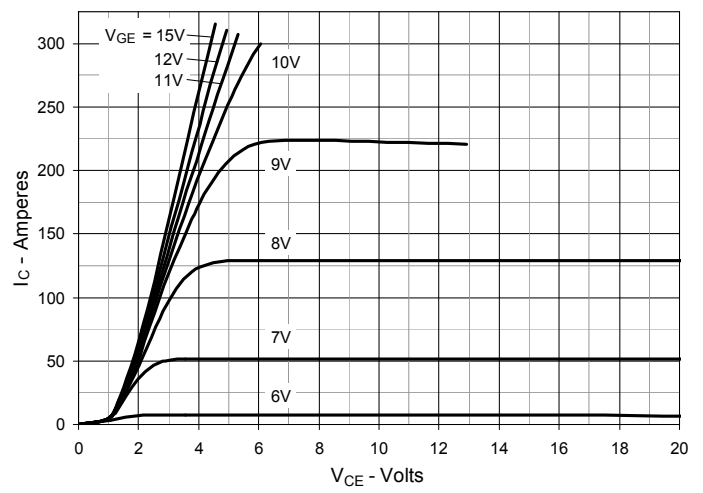

Fig. 3. Output Characteristics @ $T_J = 150^\circ\text{C}$

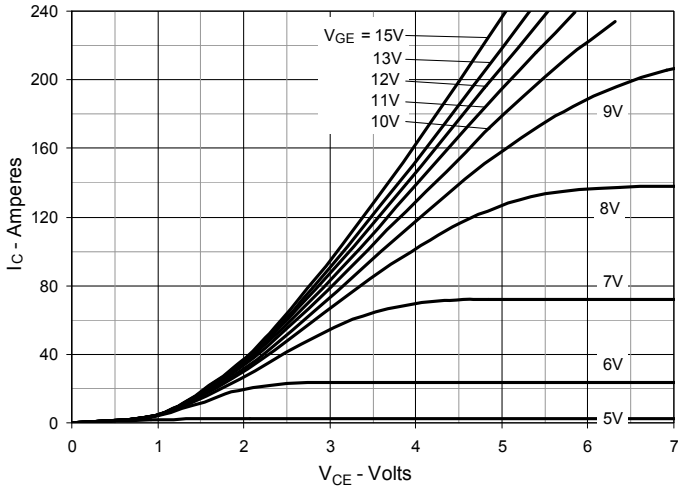

Fig. 4. Dependence of $V_{CE(sat)}$ on Junction Temperature

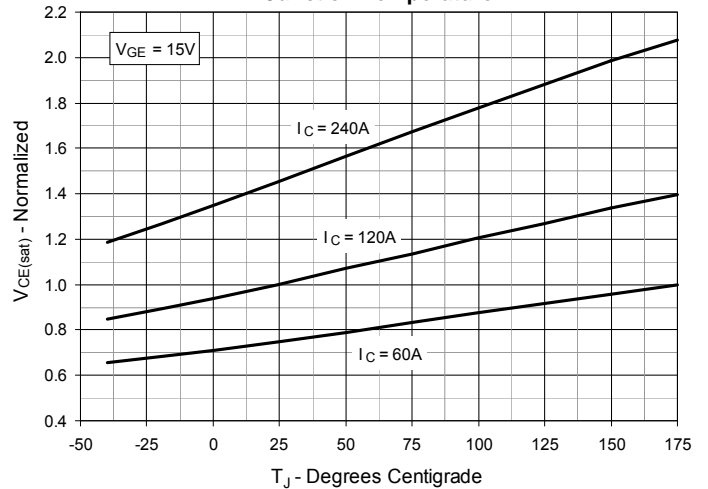

Fig. 5. Collector-to-Emitter Voltage vs. Gate-to-Emitter Voltage

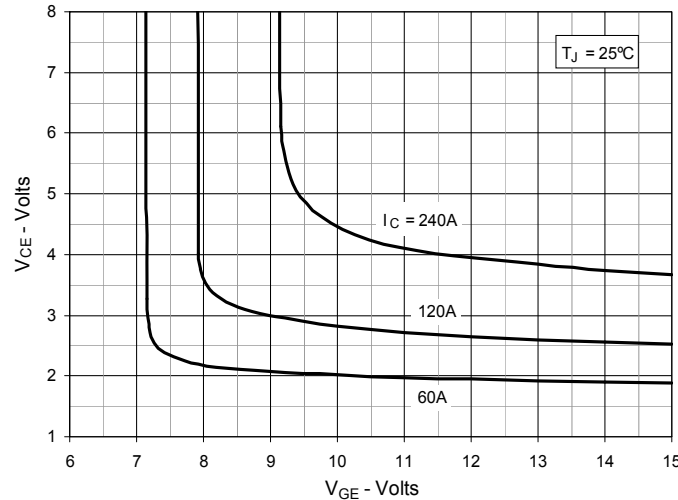

Fig. 6. Input Admittance

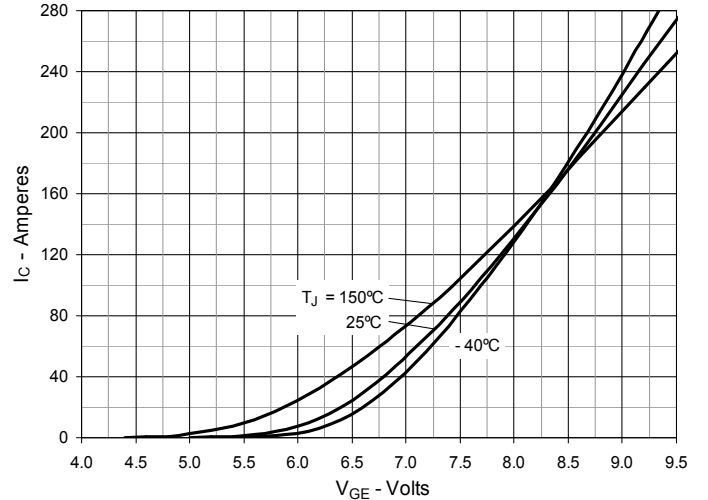

Fig. 7. Transconductance

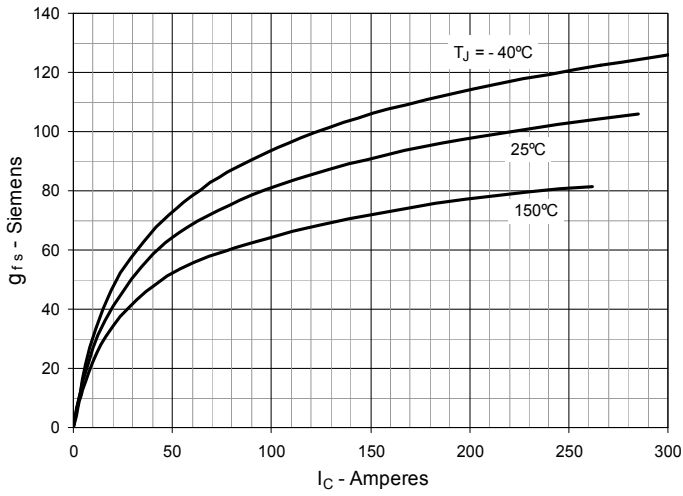

Fig. 8. Gate Charge

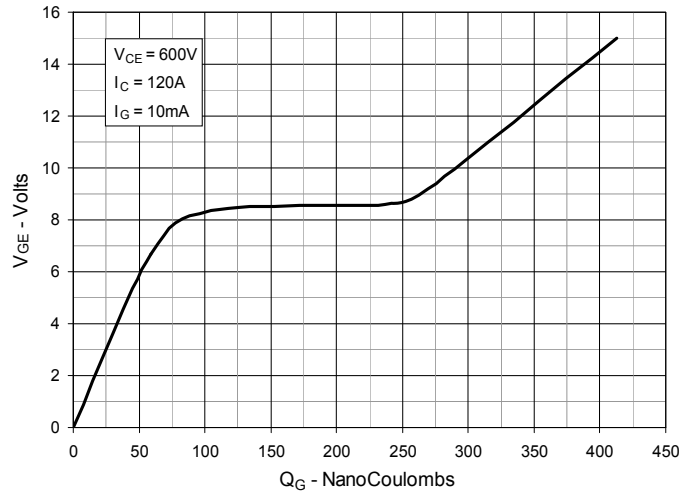

Fig. 9. Capacitance

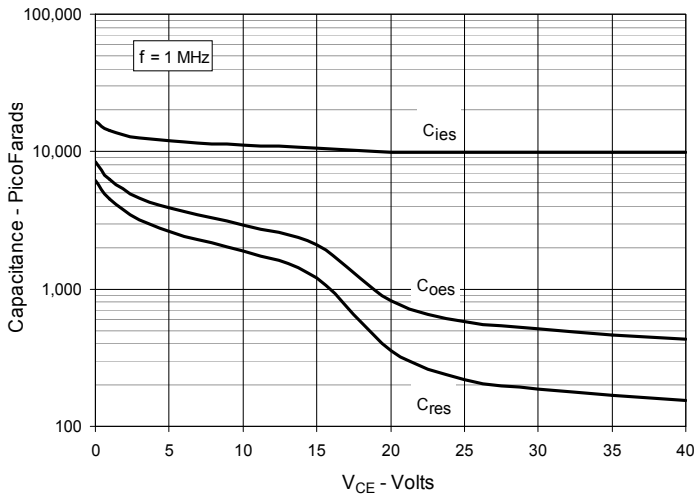

Fig. 10. Reverse-Bias Safe Operating Area

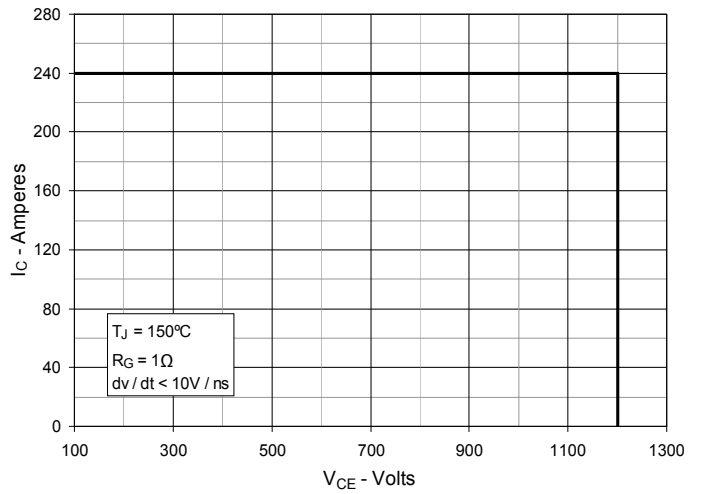

Fig. 11. Maximum Transient Thermal Impedance

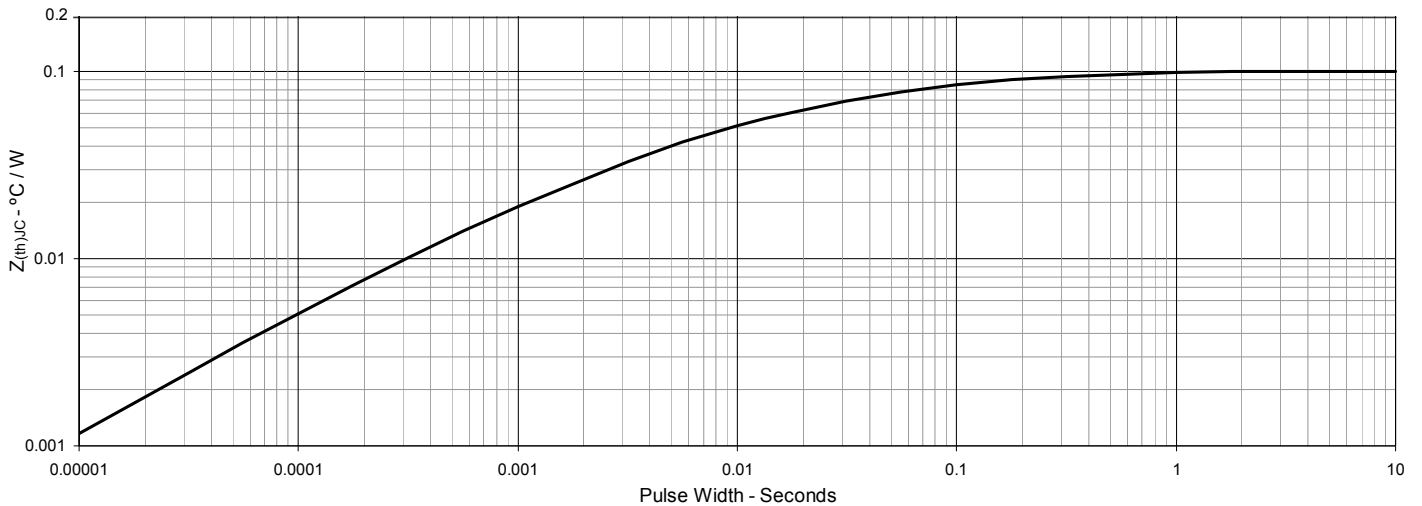

Fig. 12. Inductive Switching Energy Loss vs. Gate Resistance

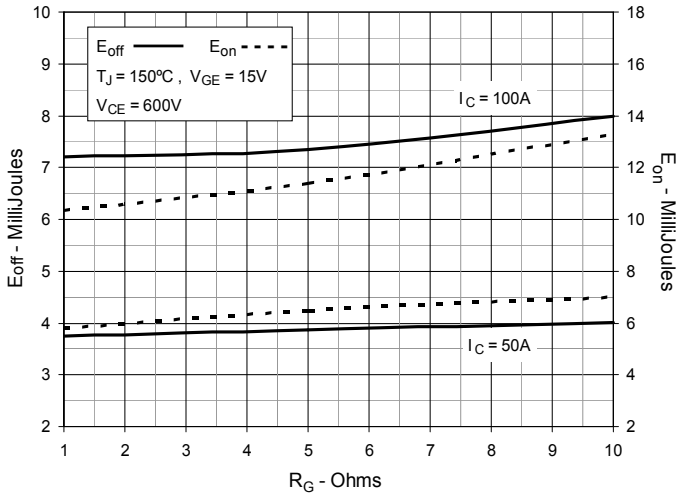

Fig. 13. Inductive Switching Energy Loss vs. Collector Current

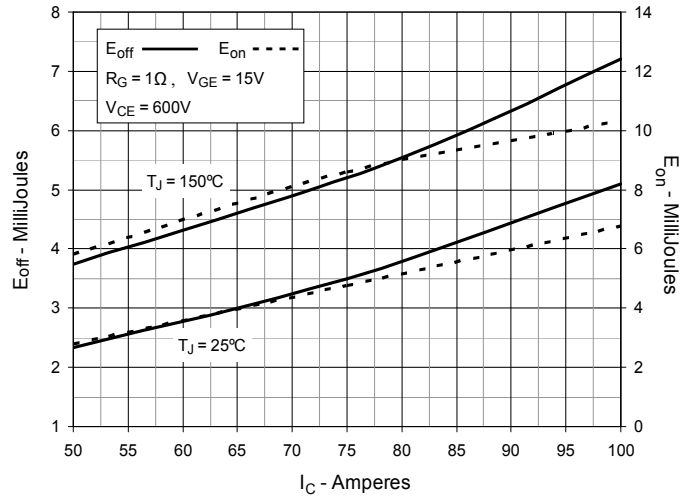

Fig. 14. Inductive Switching Energy Loss vs. Junction Temperature

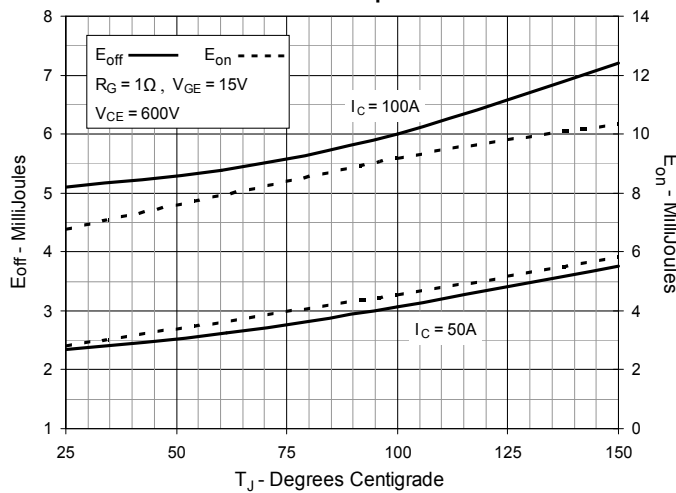

Fig. 15. Inductive Turn-off Switching Times vs. Gate Resistance

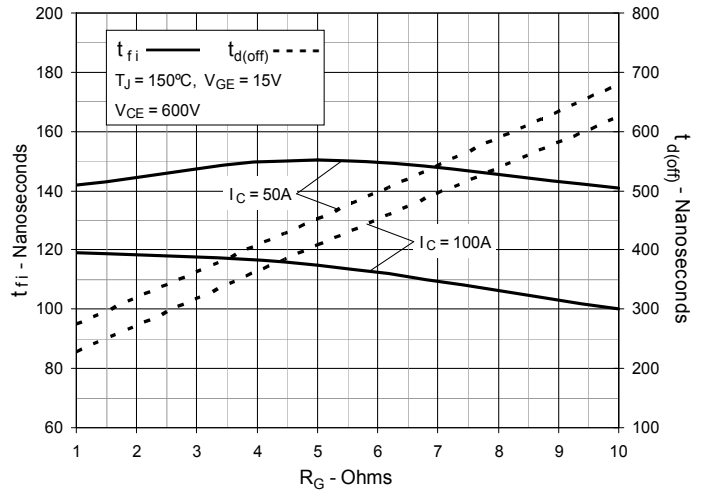

Fig. 16. Inductive Turn-off Switching Times vs. Collector Current

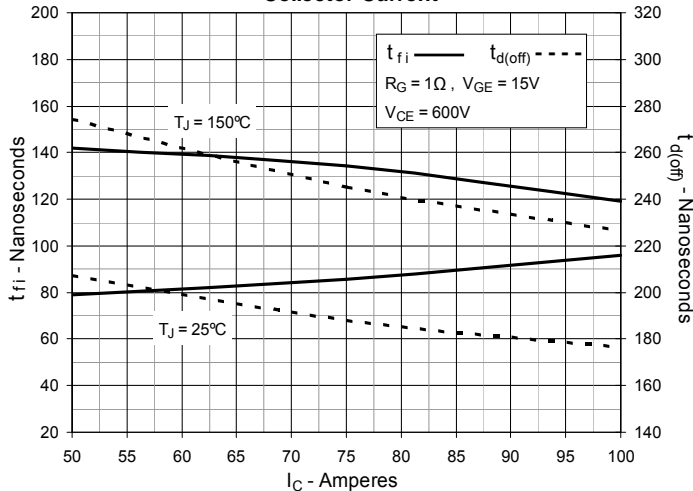

Fig. 17. Inductive Turn-off Switching Times vs. Junction Temperature

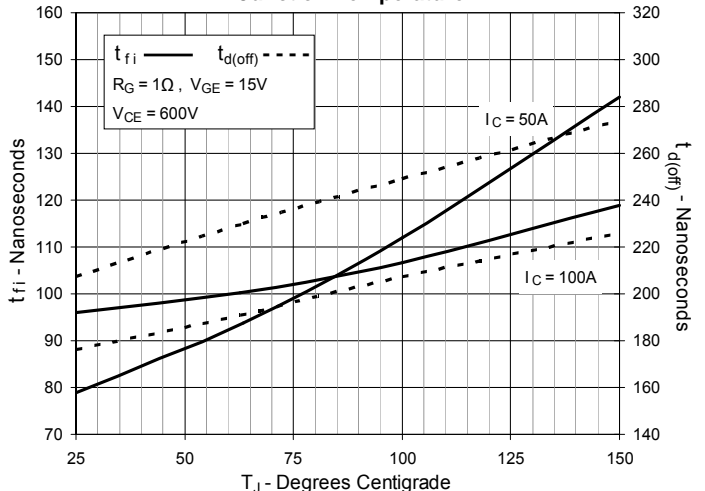

Fig. 18. Inductive Turn-on Switching Times vs. Gate Resistance

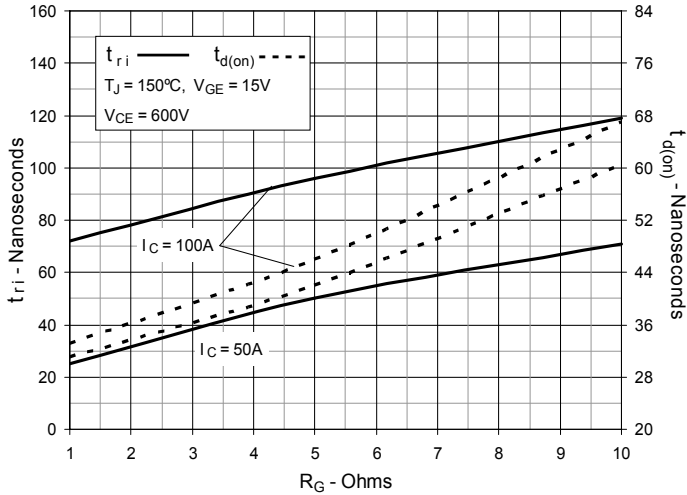

Fig. 19. Inductive Turn-on Switching Times vs. Collector Current

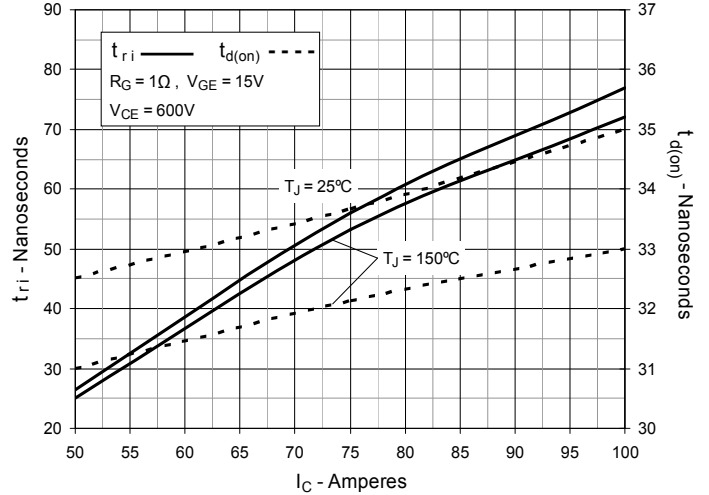

Fig. 20. Inductive Turn-on Switching Times vs. Junction Temperature

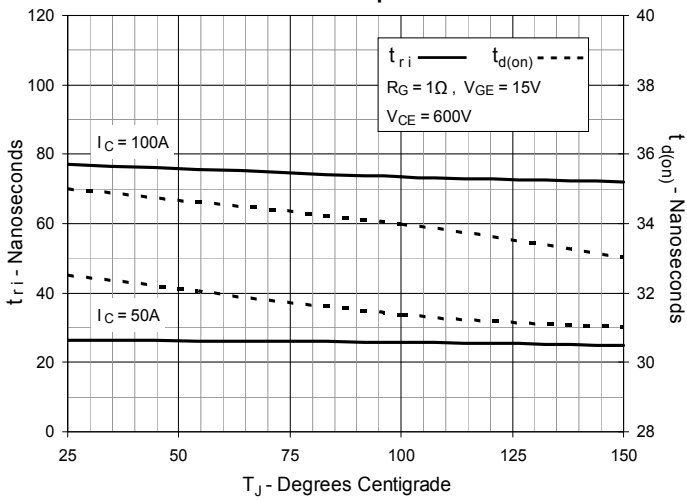
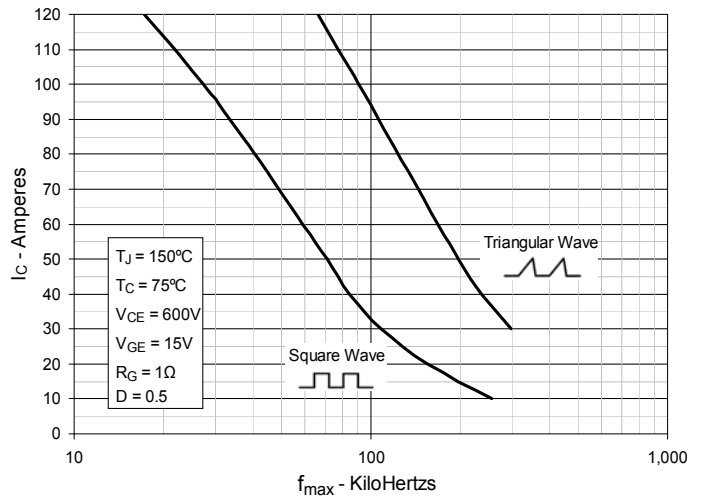

Fig. 21. Maximum Peak Load Current vs. Frequency



X-ON Electronics

Largest Supplier of Electrical and Electronic Components

Click to view similar products for [IGBT Transistors](#) category:

Click to view products by [IXYS](#) manufacturer:

Other Similar products are found below :

[748152A](#) [APT20GT60BRDQ1G](#) [APT50GT60BRG](#) [NGTB10N60FG](#) [STGFW20V60DF](#) [APT30GP60BG](#) [APT45GR65B2DU30](#)
[GT50JR22\(STA1ES\)](#) [TIG058E8-TL-H](#) [IGW40N120H3FKSA1](#) [VS-CPV364M4KPBF](#) [NGTB25N120FL2WAG](#) [NGTG40N120FL2WG](#)
[RJH60F3DPQ-A0#T0](#) [APT40GR120B2SCD10](#) [APT15GT120BRG](#) [APT20GT60BRG](#) [NGTB75N65FL2WAG](#) [NGTG15N120FL2WG](#)
[IXA30RG1200DHGLB](#) [IXA40RG1200DHGLB](#) [APT70GR65B2DU40](#) [NTE3320](#) [QP12W05S-37A](#) [IHF40N65R5SXXSA1](#) [APT70GR120J](#)
[APT35GP120JDQ2](#) [IKZA40N65RH5XKSA1](#) [IKFW75N65ES5XKSA1](#) [IKFW50N65ES5XKSA1](#) [IKFW50N65EH5XKSA1](#)
[IKFW40N65ES5XKSA1](#) [IKFW60N65ES5XKSA1](#) [IMBG120R090M1HXTMA1](#) [IMBG120R220M1HXTMA1](#) [XD15H120CX1](#)
[XD25H120CX0](#) [XP15PJS120CL1B1](#) [IGW30N60H3FKSA1](#) [STGWA8M120DF3](#) [IGW08T120FKSA1](#) [IGW75N60H3FKSA1](#)
[FGH60N60SMD_F085](#) [FGH75T65UPD](#) [STGWA15H120F2](#) [IKA10N60TXKSA1](#) [IHW20N120R5XKSA1](#) [RJH60D2DPP-M0#T2](#)
[IKP20N60TXKSA1](#) [IHW20N65R5XKSA1](#)