

Parameter	Rating	Units
Load Voltage	30	V_P
Load Current	1.5	A_{rms} / A_{DC}
On-Resistance (max)	0.3	Ω
LED Current to Operate	2	mA

Features

- 1.5A Load Current
- 0.3 Ω Max On-Resistance
- 2mA Control Current
- 3750V_{rms} Input/Output Isolation
- Low Drive Power Requirements
- High Reliability
- Arc-Free With No Snubbing Circuits
- No EMI/RFI Generation
- Flammability Rating UL 94 V-0
- Small 6-Pin Package
- Tape & Reel, Surface Mount Version Available

Applications

- Sensor Circuitry
- Instrumentation
- Multiplexers
- Data Acquisition
- Electronic Switching
- I/O Subsystems
- Medical Equipment-Patient/Equipment Isolation
- Security
- Aerospace
- Industrial Controls

Description

LCB717 is a single-pole normally closed (1-Form-B) solid state relay that uses optically coupled technology to provide an enhanced 3750V_{rms} isolation barrier between the input and the output of the relay. The efficient MOSFET switches use IXYS Integrated Circuits' patented OptoMOS architecture. The optically coupled output is controlled by a highly efficient infrared LED.

Approvals

- UL Recognized Component: File E76270
- CSA Certified Component: Certificate 1175739
- EN/IEC 60950-1 Certified Component:
Certificate available on our website

Ordering Information

Part #	Description
LCB717	6-Lead DIP (50/Tube)
LCB717S	6-Lead Surface Mount (50/Tube)
LCB717STR	6-Lead Surface Mount (1000/Reel)

Pin Configuration

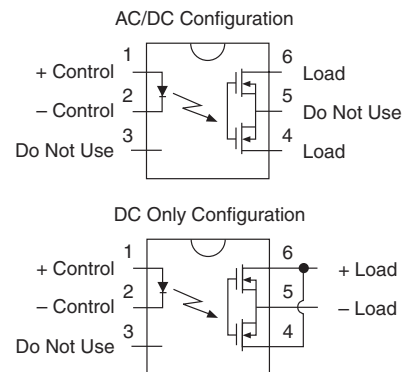

Switching Characteristics of Normally Closed Devices

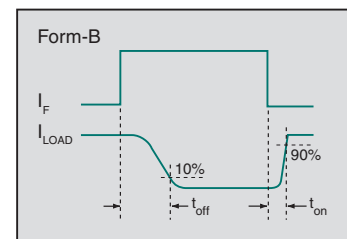

Absolute Maximum Ratings @ 25°C

Parameter	Ratings	Units
Blocking Voltage	30	V _P
Reverse Input Voltage	5	V
Input Control Current	50	mA
Peak (10ms)	1	A
Input Power Dissipation ¹	100	mW
Total Power Dissipation ²	800	mW
Isolation Voltage, Input to Output	3750	V _{rms}
ESD Rating, Human Body Model	8	kV
Operational Temperature	-40 to +85	°C
Storage Temperature	-40 to +125	°C

¹ Derate linearly 1.33 mW / °C

² Derate linearly 6.67 mW / °C

Absolute Maximum Ratings are stress ratings. Stresses in excess of these ratings can cause permanent damage to the device. Functional operation of the device at conditions beyond those indicated in the operational sections of this data sheet is not implied.

Typical values are characteristic of the device at +25°C, and are the result of engineering evaluations. They are provided for information purposes only, and are not part of the manufacturing testing requirements.

Electrical Characteristics @ 25°C

Parameter	Conditions	Symbol	Min	Typ	Max	Units
Output Characteristics						
Load Current						
AC/DC Configuration, Continuous	I _F =0mA	I _L	-	-	1.5	A _{rms} / A _{DC}
DC Configuration, Continuous			-	-	3	A _{DC}
Peak	I _F =0mA, t ≤ 10ms	I _{LPK}	-	-	5	A
On-Resistance ¹						
AC/DC Configuration	I _F =0mA, I _L =1.5A	R _{ON}	-	-	0.3	Ω
DC Configuration			I _F =0mA, I _L =3A	-	-	
Switching Speeds						
Turn-On	I _F =5mA, V _L =10V	t _{on}	-	-	2	ms
Turn-Off		t _{off}	-	-	5	
Off-State Leakage Current	I _F =2mA, V _L =30V	I _{LEAK}	-	-	1	μA
Output Capacitance	I _F =2mA, V _L =25V, f=1MHz	C _{OUT}	-	160	-	pF
	I _F =2mA, V _L =1V, f=1MHz		-	459	-	
Input Characteristics						
Input Control Current to Activate ²	I _L =1A	I _F	-	-	2	mA
Input Control Current to Deactivate	-	I _F	0.1	-	-	mA
Input Voltage Drop	I _F =5mA	V _F	0.9	1.2	1.5	V
Reverse Input Current	V _R =5V	I _R	-	-	10	μA
Common Characteristics						
Capacitance, Input to Output	V _{IO} =0V, f=1MHz	C _{IO}	-	3	-	pF

¹ Measurement taken within 1 second of on-time.

² For high temperature operation (>60°C) a minimum LED drive current of 4mA is recommended.

PERFORMANCE DATA *

Typical LED Forward Voltage Drop
(N=50, $I_F=5mA$)

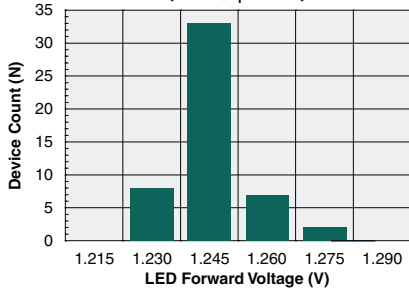

Typical Turn-On Time
(N=50, $I_F=5mA$, $I_L=100mA$)

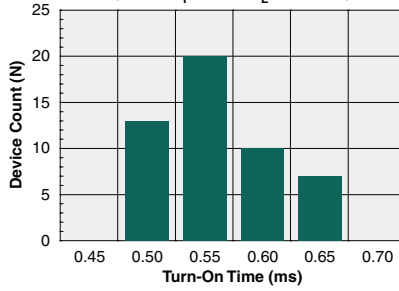

Typical Turn-Off Time
(N=50, $I_F=5mA$, $I_L=100mA$)

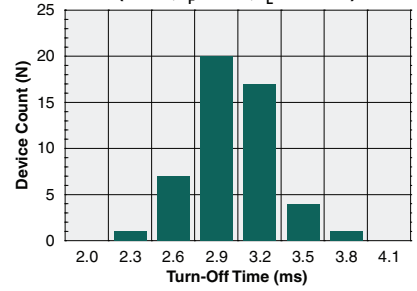

Typical LED Current to Operate
(N=50, $I_L=100mA$)

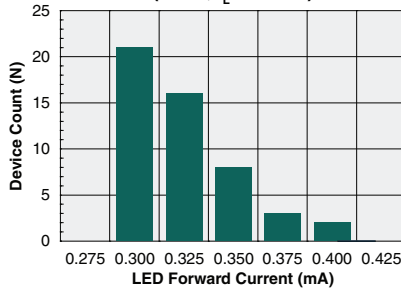

Typical Blocking Voltage Distribution
(N=50, $I_F=2mA$)

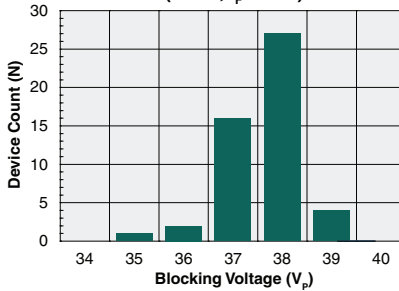

Typical On-Resistance Distribution
(N=50, $I_F=0mA$, $I_L=1A$)

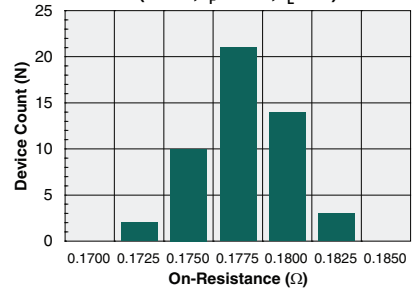

Typical LED Forward Voltage Drop vs. Temperature

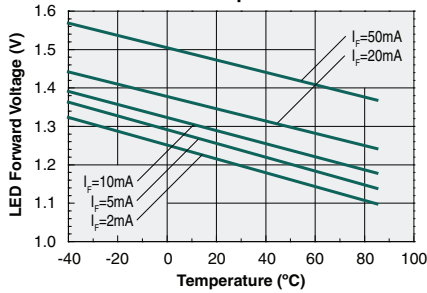

Typical Turn-On Time vs. LED Forward Current
($I_L=100mA$)

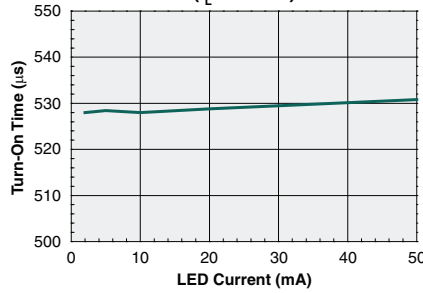

Typical Turn-Off Time vs. LED Forward Current
($I_L=100mA$)

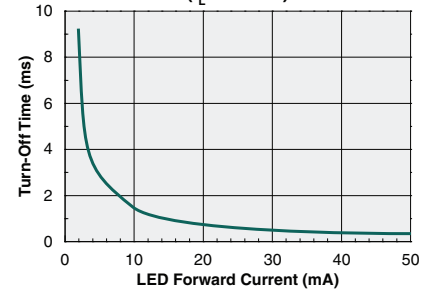

Typical LED Current to Operate vs. Temperature
($I_L=750mA$)

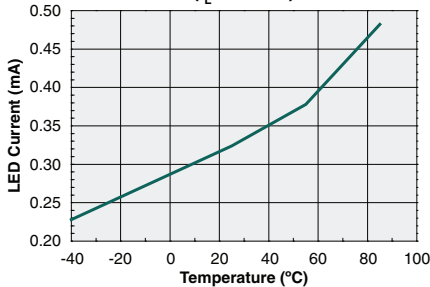

Typical Turn-On Time vs. Temperature
($V_L=10V$, $I_L=100mA$)

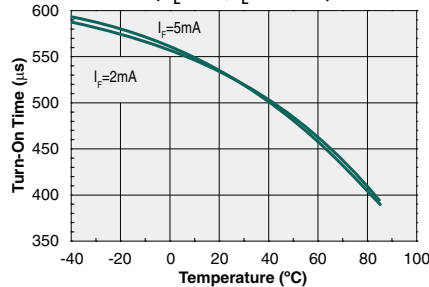

Typical Turn-Off Time vs. Temperature
($I_L=100mA$)

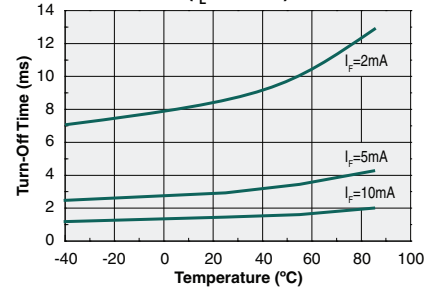

*Unless otherwise noted, data presented in these graphs is typical of device operation at 25°C.
For guaranteed parameters not indicated in the written specifications, please contact our application department.

PERFORMANCE DATA*

Typical On-Resistance vs. Temperature
AC/DC Configuration
($I_F=0mA, I_L=750mA$)

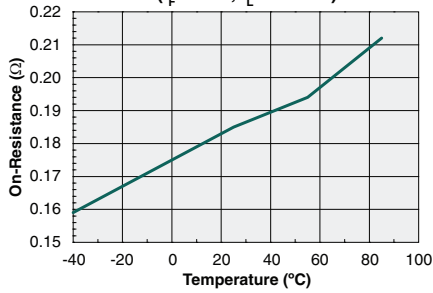

Typical Load Current vs. Load Voltage
AC/DC Configuration
($I_F=0mA$)

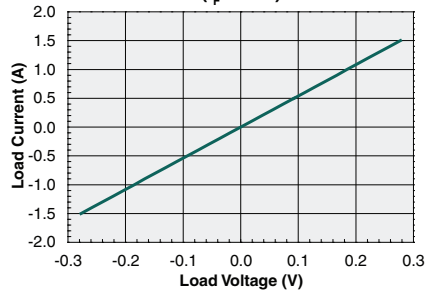

Maximum Load Current vs. Temperature
AC/DC Configuration
($I_F=0mA$)

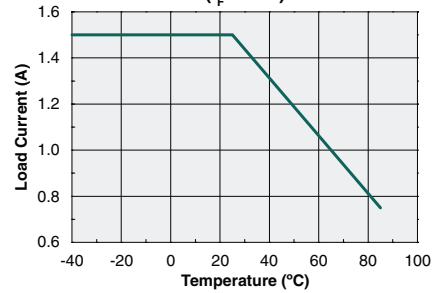

Typical On-Resistance vs. Temperature
DC-Only Configuration
($I_F=0mA, I_L=1.5A$)

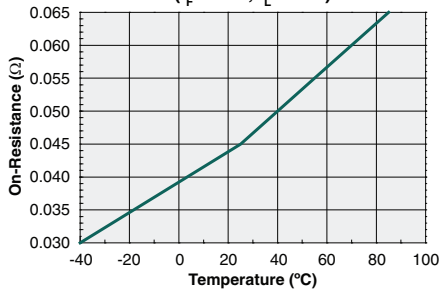

Typical Load Current vs. Load Voltage
DC-Only Configuration
($I_F=0mA$)

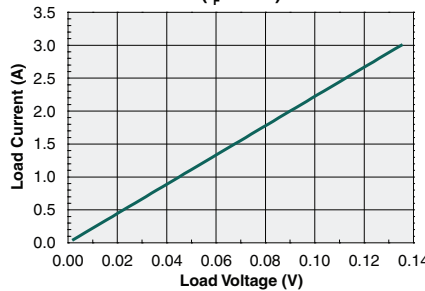

Maximum Load Current vs. Temperature
DC-Only Configuration
($I_F=0mA$)

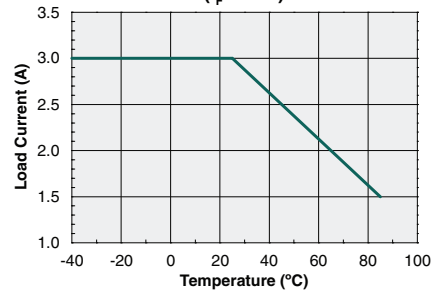

Typical Blocking Voltage
vs. Temperature
($I_F=4mA$)

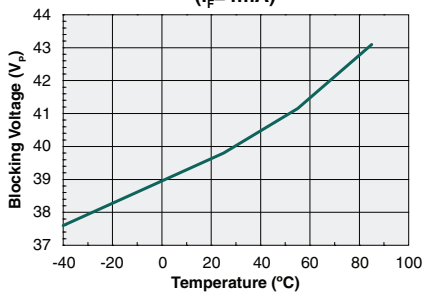

Leakage Current vs. Temperature
Measured Across Pins 4 & 6
($I_F=4mA, V_L=30V$)

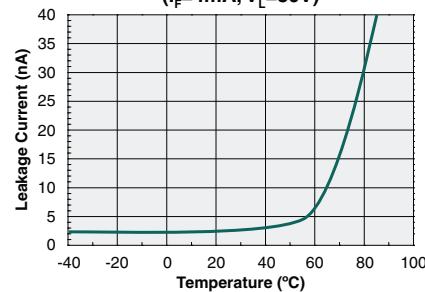

Output Capacitance vs. Load Voltage
($I_F=2mA, f=1MHz$)

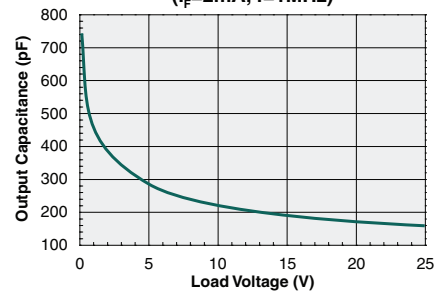

Energy Rating Curve

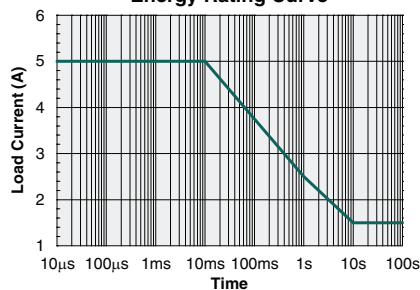

*Unless otherwise noted, data presented in these graphs is typical of device operation at 25°C.
For guaranteed parameters not indicated in the written specifications, please contact our application department.

Manufacturing Information

Moisture Sensitivity



All plastic encapsulated semiconductor packages are susceptible to moisture ingress. IXYS Integrated Circuits classifies its plastic encapsulated devices for moisture sensitivity according to the latest version of the joint industry standard, **IPC/JEDEC J-STD-020**, in force at the time of product evaluation. We test all of our products to the maximum conditions set forth in the standard, and guarantee proper operation of our devices when handled according to the limitations and information in that standard as well as to any limitations set forth in the information or standards referenced below.

Failure to adhere to the warnings or limitations as established by the listed specifications could result in reduced product performance, reduction of operable life, and/or reduction of overall reliability.

This product carries a Moisture Sensitivity Level (MSL) classification as shown below, and should be handled according to the requirements of the latest version of the joint industry standard **IPC/JEDEC J-STD-033**.

Device	Moisture Sensitivity Level (MSL) Classification
LCB717 / LCB717S	MSL 1

ESD Sensitivity



This product is **ESD Sensitive**, and should be handled according to the industry standard **JESD-625**.

Soldering Profile

Provided in the table below is the Classification Temperature (T_C) of this product and the maximum dwell time the body temperature of this device may be ($T_C - 5$)°C or greater. The classification temperature sets the Maximum Body Temperature allowed for this device during lead-free reflow processes. For through-hole devices, and any other processes, the guidelines of **J-STD-020** must be observed.

Device	Classification Temperature (T_C)	Dwell Time (t_p)	Max Reflow Cycles
LCB717	250°C	30 seconds	1
LCB717S	250°C	30 seconds	3

Board Wash

IXYS Integrated Circuits recommends the use of no-clean flux formulations. Board washing to reduce or remove flux residue following the solder reflow process is acceptable provided proper precautions are taken to prevent damage to the device. These precautions include, but are not limited to: using a low pressure wash and providing a follow up bake cycle sufficient to remove any moisture trapped within the device due to the washing process. Due to the variability of the wash parameters used to clean the board, determination of the bake temperature and duration necessary to remove the moisture trapped within the package is the responsibility of the user (assembler). Cleaning or drying methods that employ ultrasonic energy may damage the device and should not be used. Additionally, the device must not be exposed to flux or solvents that are Chlorine- or Fluorine-based.



Mechanical Dimensions

LCB717

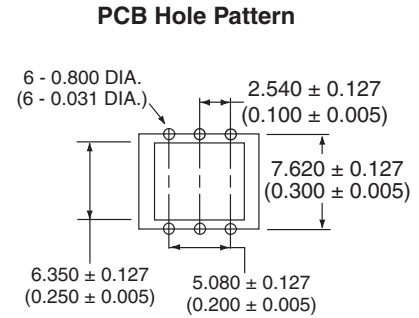
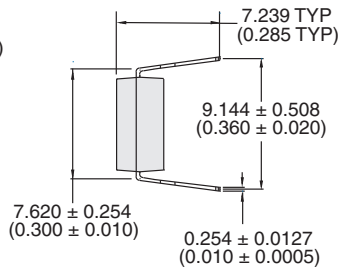
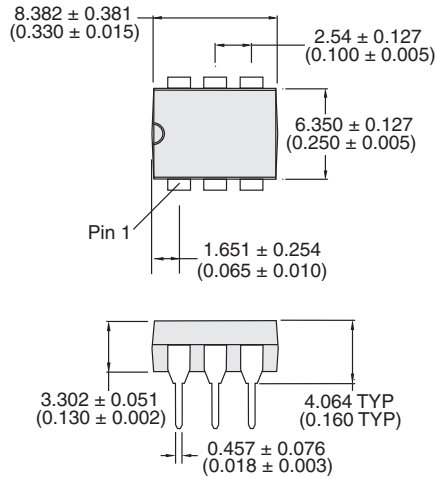

Dimensions
mm
(inches)

LCB717S

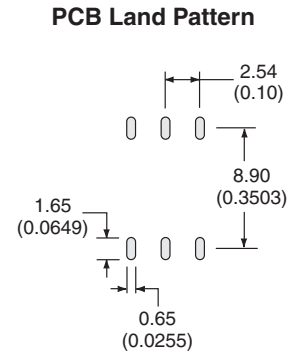
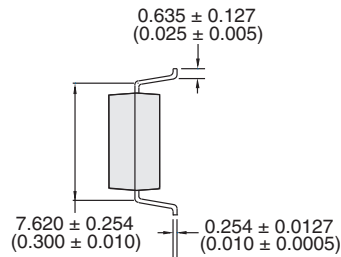
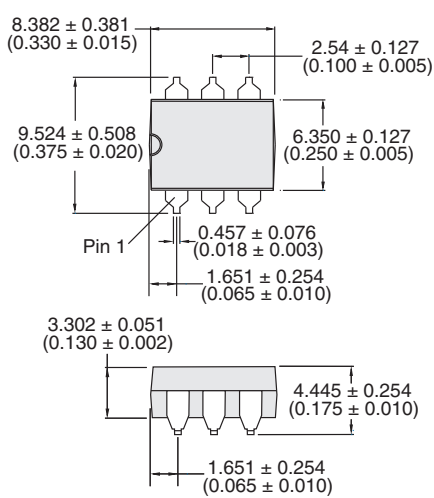

Dimensions
mm
(inches)

LCB717S Tape & Reel

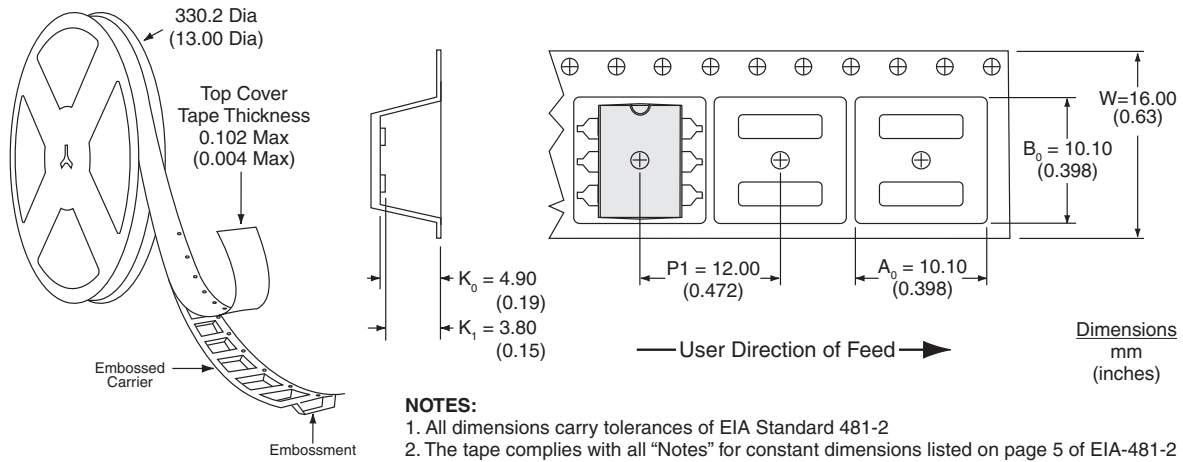

For additional information please visit our website at: www.ixysic.com

IXYS Integrated Circuits makes no representations or warranties with respect to the accuracy or completeness of the contents of this publication and reserves the right to make changes to specifications and product descriptions at any time without notice. Neither circuit patent licenses nor indemnity are expressed or implied. Except as set forth in IXYS Integrated Circuits' Standard Terms and Conditions of Sale, IXYS Integrated Circuits assumes no liability whatsoever, and disclaims any express or implied warranty, relating to its products including, but not limited to, the implied warranty of merchantability, fitness for a particular purpose, or infringement of any intellectual property right.

The products described in this document are not designed, intended, authorized or warranted for use as components in systems intended for surgical implant into the body, or in other applications intended to support or sustain life, or where malfunction of IXYS Integrated Circuits' product may result in direct physical harm, injury, or death to a person or severe property or environmental damage. IXYS Integrated Circuits reserves the right to discontinue or make changes to its products at any time without notice.

X-ON Electronics

Largest Supplier of Electrical and Electronic Components

Click to view similar products for [Solid State Relays - PCB Mount](#) category:

Click to view products by [IXYS](#) manufacturer:

Other Similar products are found below :

[M86F-2W](#) [M90F-2W](#) [G2-1A07-ST](#) [G2-1A07-TT](#) [G2-1B02-TT](#) [G2-DA06-ST](#) [G3CN-202PL-3-US DC12](#) [G3CN-203P DC3-28](#)
[G3RDX02SNUSDC12](#) [PLA134S](#) [DMP6202A](#) [DS11-1005](#) [AQ3A2-ZT432VDC](#) [AQV212J](#) [AQV214SD02](#) [AQV252GAJ](#) [AQW414EA](#)
[AQY221N2SJ](#) [AQY221R2SJ](#) [EFR1200480A150](#) [LCA220](#) [LCB110S](#) [1618400-5](#) [SR75-1ST](#) [AQV112KLJ](#) [AQV212AJ](#) [AQV238AD01](#)
[AQV252GAXJ](#) [AQW414TS](#) [AQY210SXT](#) [AQY214SXT](#) [AQY221N2V1YJ](#) [AQY221R2VJ](#) [G2-1A02-ST](#) [G2-1A02-TT](#) [G2-1A03-ST](#) [G2-1A03-TT](#) [G2-1A06-TT](#) [G2-1A23-TT](#) [G2-1B01-ST](#) [G2-1B01-TT](#) [G2-1B02-ST](#) [G2-DA03-ST](#) [G2-DA03-TT](#) [G2-DA06-TT](#) [G3M-203PL-UTU-1 DC24](#) [CPC2330N](#) [3-1617776-2](#) [CTA2425](#) [TS190](#)