

Parameters	Ratings	Units
Blocking Voltage	350	V _P
Load Current	120	mA _{rms} / mA _{DC}
On-Resistance (max)	35	Ω

Features

- 3750V_{rms} Input/Output Isolation
- 1-Form-C Solid State Relay
- Low Drive Power Requirements
- Greater Reliability than Electromechanical Relays
- FCC Compatible
- VDE Compatible
- No EMI/RFI Generation
- Small 8-pin Packages
- Flammability Rating UL 94 V-0
- Surface Mount Tape & Reel Versions Available

Applications

- Telecommunications
 - Telecom Switching
 - Tip/Ring Circuits
 - Modem Switching (Laptop, Notebook, Pocket Size)
 - Hook Switch
 - Dial Pulsing
 - Ground Start
 - Ringing Injection
- Instrumentation
- Multiplexers
- Data Acquisition
- Electronic Switching
- I/O Subsystems
- Meters (Watt-Hour, Water, Gas)
- Medical Equipment—Patient/Equipment Isolation
- Security
- Industrial Controls

Description

LCC110P is a 350V, 120mA, 35Ω, 1-Form-C relay. This device is ideal for applications where a signal needs to be switched between two different lines. The small 8-lead package makes it an ideal space-saving replacement for a 1-Form-C electromechanical relay (EMR).

Approvals

- UL Recognized Component: File E76270
- CSA Certified Component: Certificate 1175739
- TUV EN 62368-1: Certificate # B 082667 0008

Ordering Information

Part #	Description
LCC110	8-Pin DIP (50/Tube)
LCC110P	8-Pin Flatpack (50/Tube)
LCC110PTR	8-Pin Flatpack Tape & Reel (1000/Reel)
LCC110S	8-Pin Surface Mount (50/Tube)
LCC110STR	8-Pin Surface Mount Tape & Reel (1000/Reel)

Pin Configuration

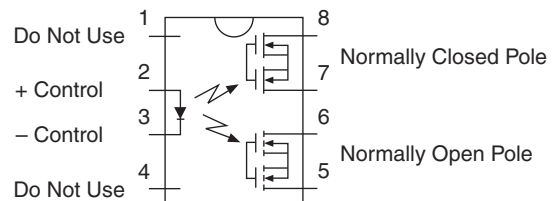

Switching Characteristics for a 1-Form-C Device

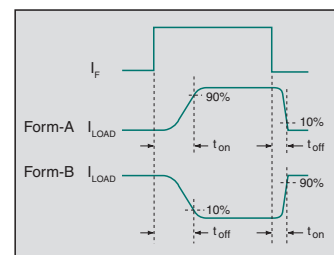

Absolute Maximum Ratings @ 25°C

Parameter	Min	Max	Unit
Blocking Voltage	-	350	V _P
Reverse Input Voltage	-	5	V
Input control Current	-	50	mA
Peak (10ms)	-	1	A
Input Power Dissipation ¹	-	150	mW
Total Power Dissipation ²	-	800	mW
Isolation Voltage, Input to Output	3750	-	V _{rms}
Operating Temperature, Ambient	-40	+85	°C
Storage Temperature	-40	+125	°C

Absolute Maximum Ratings are stress ratings. Stresses in excess of these ratings can cause permanent damage to the device. Functional operation of the device at conditions beyond those indicated in the operational sections of this data sheet is not implied.

Typical values are characteristic of the device at +25°C, and are the result of engineering evaluations. They are provided for information purposes only, and are not part of the manufacturing testing requirements.

¹ Derate linearly 1.33mW / °C.

² Derate output power linearly 6.67mW / °C.

Electrical Characteristics @ 25°C

Parameter	Conditions	Symbol	Min	Typ	Max	Units
Output Characteristics						
Blocking Voltage	I _L =1μA	V _{DRM}	350	-	-	V _P
Load Current ¹						
Continuous	-	I _L	-	-	120	mA _{rms} / mA _{DC}
Peak	t=10ms	I _{LPK}	-	-	±350	mA _P
On-Resistance ²	I _L =120mA	R _{ON}	-	23	35	Ω
Off-State Leakage Current	V _L =350V _P	I _{LEAK}	-	-	1	μA
Switching Speeds						
Turn-On	I _F =8mA, V _L =10V	t _{on}	-	-	4	ms
Turn-Off		t _{off}	-	-	4	
Output Capacitance	V _L =50V, f=1MHz	C _{OUT}	-	25	-	pF
Input Characteristics						
Input Control Current to Activate	I _L =120mA	I _F	-	-	8	mA
Input Control Current to Deactivate	-	I _F	0.4	0.7	-	mA
Input Voltage Drop	I _F =10mA	V _F	0.9	1.42	1.56	V
Reverse Input Current	V _R =5V	I _R	-	-	10	μA
Common Characteristics						
Capacitance, Input to Output	-	C _{I/O}	-	3	-	pF

¹ If both poles operate simultaneously, then load current must be derated in order not to exceed package power dissipation value.

² Measurement taken within one second of on-time.

COMMON PERFORMANCE DATA*

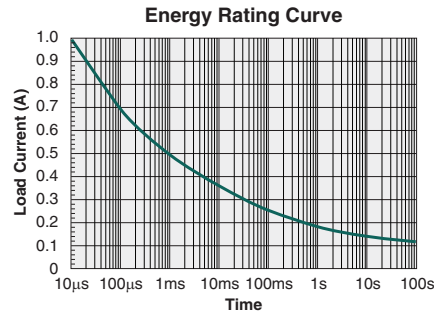
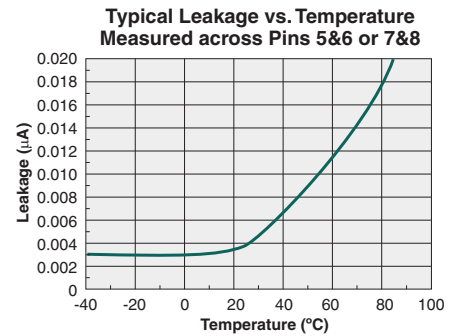
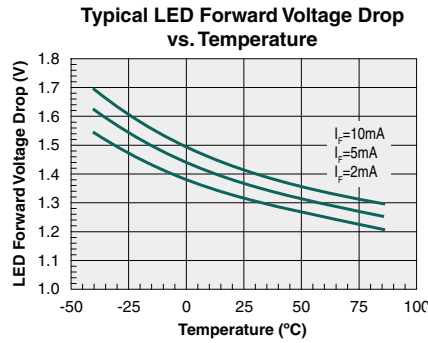
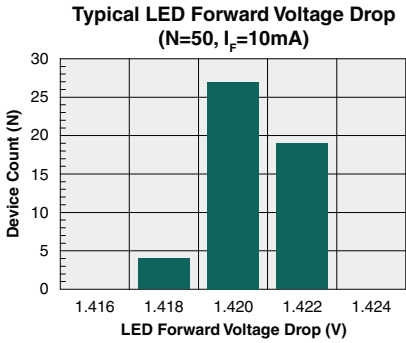

FORM-A RELAY PERFORMANCE DATA*

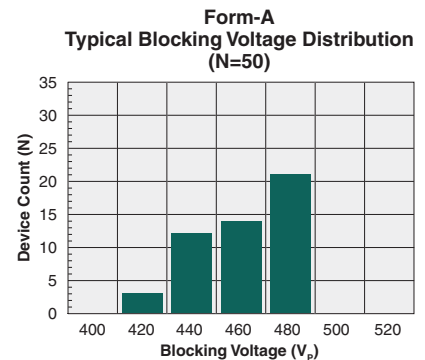
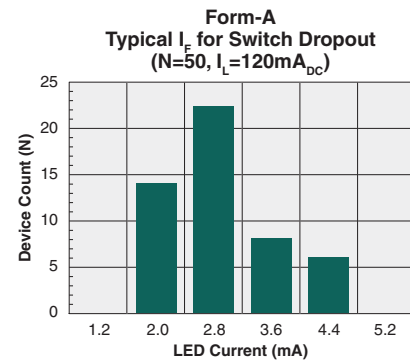
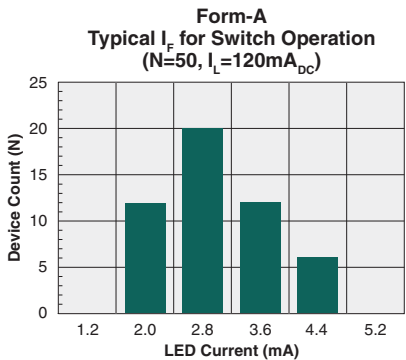
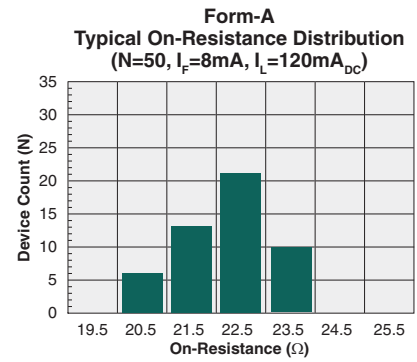
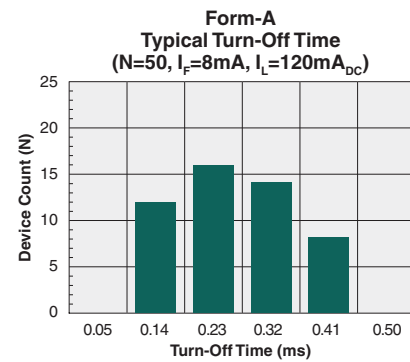
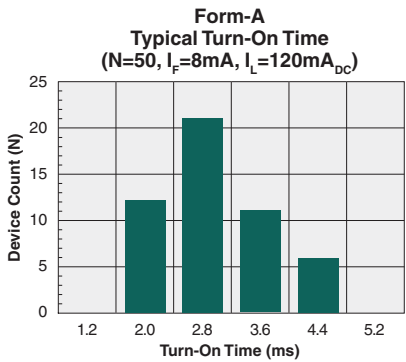

*Unless otherwise noted, data presented in these graphs is typical of device operation at 25°C.

FORM-A RELAY PERFORMANCE DATA*

Form-A
Typical Turn-On Time
vs. LED Forward Current
($I_L=120mA_{DC}$)

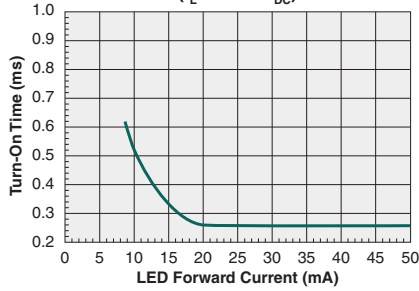

Form-A
Typical I_F for Switch Operation
vs. Temperature
($I_L=120mA_{DC}$)

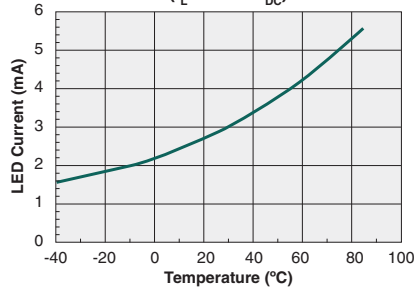

Form-A
Typical Turn-On Time
vs. Temperature
($I_L=120mA_{DC}$)

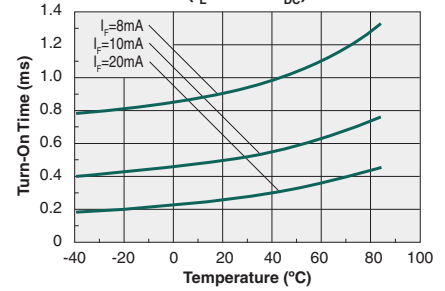

Form-A
Typical Turn-Off Time
vs. LED Forward Current
($I_L=120mA_{DC}$)

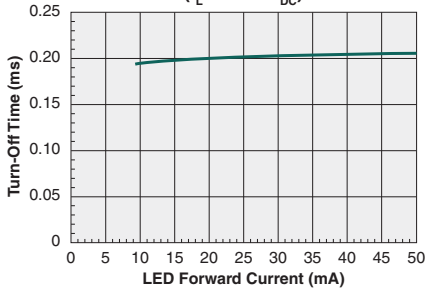

Form-A
Typical I_F for Switch Dropout
vs. Temperature
($I_L=120mA_{DC}$)

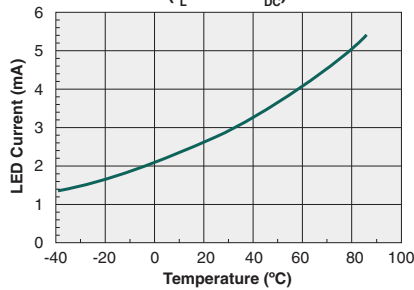

Form-A
Typical Turn-Off Time
vs. Temperature
($I_F=5mA, I_L=120mA_{DC}$)

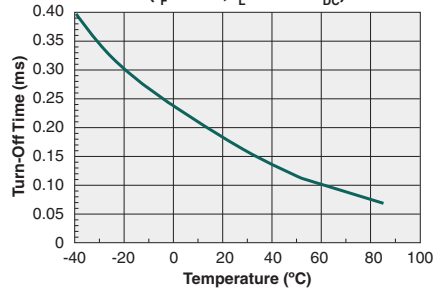

Form-A
Typical On-Resistance
vs. Temperature
($I_F=8mA, I_L=120mA_{DC}$)

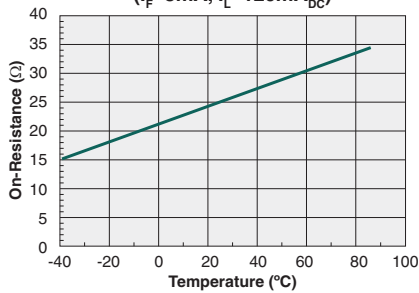

Form-A
Typical Load Current vs. Load Voltage
($I_F=8mA$)

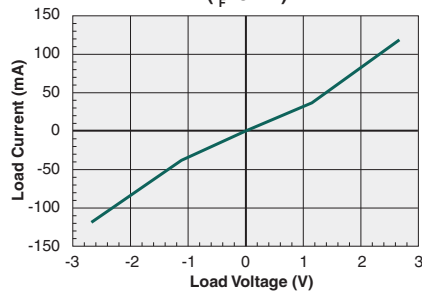

Form-A
Maximum Load Current
vs. Temperature

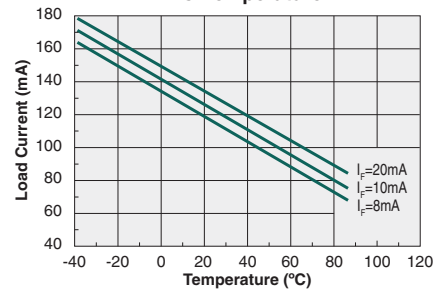

Form-A
Typical Blocking Voltage
vs. Temperature

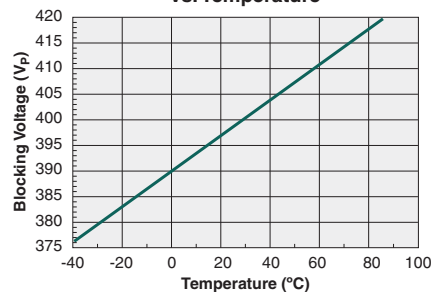

*Unless otherwise noted, data presented in these graphs is typical of device operation at 25°C.

FORM-B RELAY PERFORMANCE DATA*

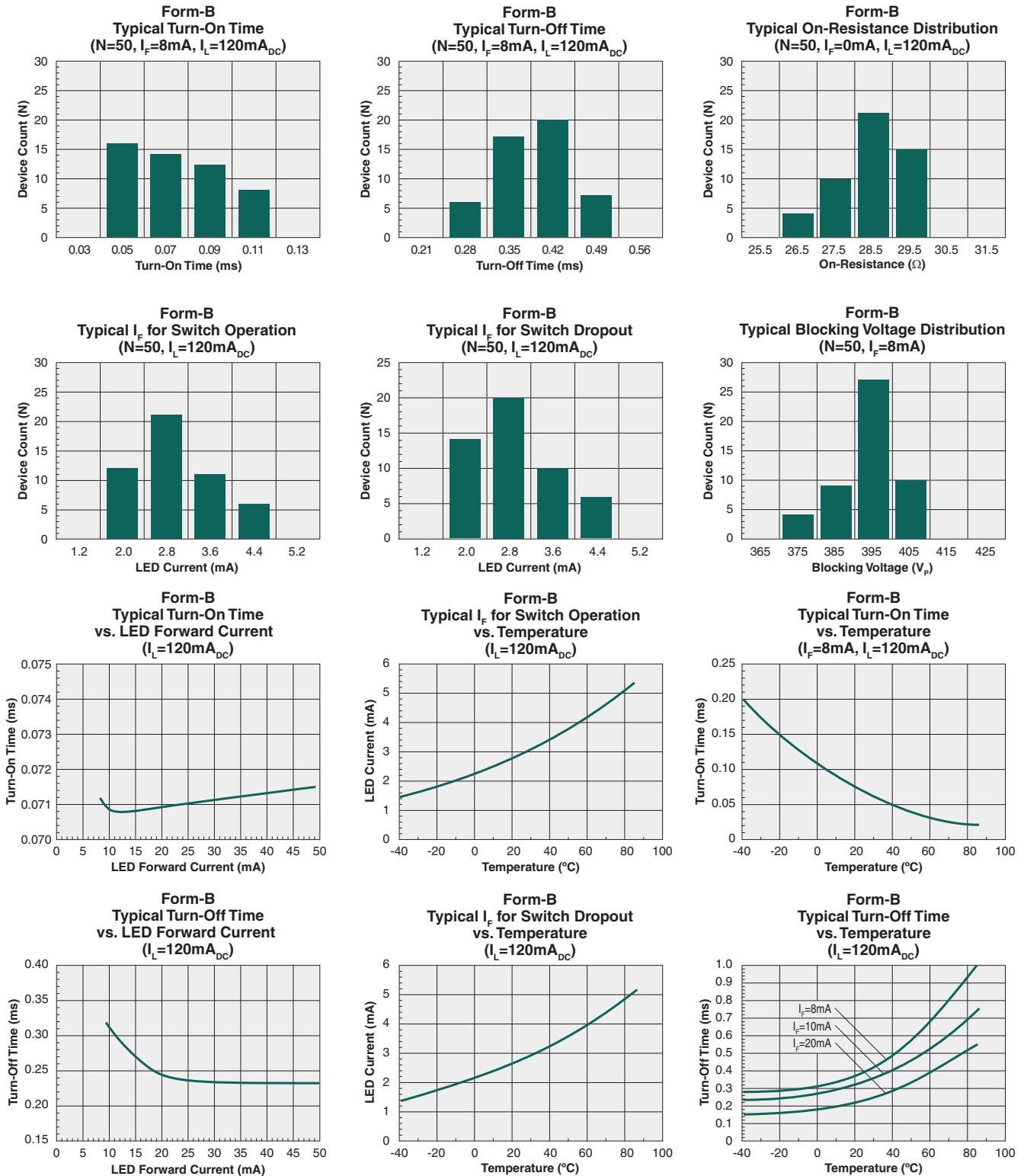

*Unless otherwise noted, data presented in these graphs is typical of device operation at 25°C.

FORM-B RELAY PERFORMANCE DATA*

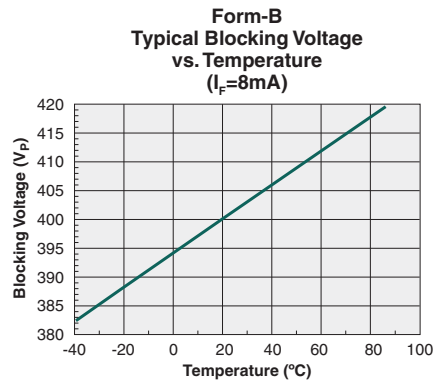
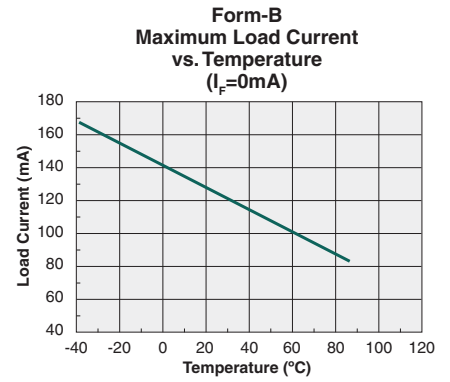
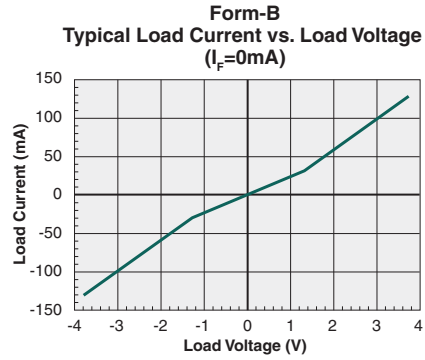
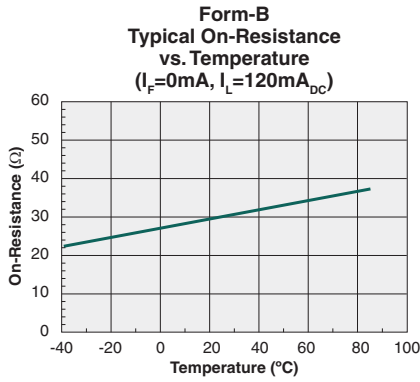

*Unless otherwise noted, data presented in these graphs is typical of device operation at 25°C.

Manufacturing Information

Moisture Sensitivity



All plastic encapsulated semiconductor packages are susceptible to moisture ingress. IXYS Integrated Circuits classifies its plastic encapsulated devices for moisture sensitivity according to the latest version of the joint industry standard, **IPC/JEDEC J-STD-020**, in force at the time of product evaluation. We test all of our products to the maximum conditions set forth in the standard, and guarantee proper operation of our devices when handled according to the limitations and information in that standard as well as to any limitations set forth in the information or standards referenced below.

Failure to adhere to the warnings or limitations as established by the listed specifications could result in reduced product performance, reduction of operable life, and/or reduction of overall reliability.

This product carries a **Moisture Sensitivity Level (MSL)** classification as shown below, and should be handled according to the requirements of the latest version of the joint industry standard **IPC/JEDEC J-STD-033**.

Device	Moisture Sensitivity Level (MSL) Classification
LCC110S / LCC110P	MSL 1

ESD Sensitivity



This product is ESD Sensitive, and should be handled according to the industry standard **JESD-625**.

Soldering Profile

Provided in the table below is the **IPC/JEDEC J-STD-020** Classification Temperature (T_C) and the maximum total dwell time (t_p) in all reflow processes that the body temperature of these surface mount devices may be ($T_C - 5$)°C or greater. The device's body temperature must not exceed the Classification Temperature at any time during reflow soldering processes.

Device	Classification Temperature (T_C)	Dwell Time (t_p)	Max Reflow Cycles
LCC110S	250°C	30 seconds	3
LCC110P	260°C	30 seconds	3

For through-hole devices, the maximum pin temperature and maximum dwell time through all solder waves is provided in the table below. Dwell time is the interval beginning when the pins are initially immersed into the solder wave until they exit the solder wave. For multiple waves, the dwell time is from entering the first wave until exiting the last wave. During this time, pin temperatures must not exceed the maximum temperature given in the table below. Body temperature of the device must not exceed the limit shown in the table below at any time during the soldering process.

Device	Maximum Pin Temperature	Maximum Body Temperature	Maximum Dwell Time	Wave Cycles
LCC110	260°C	250°C	10 seconds*	1

*Total cumulative duration of all waves.

Board Wash

IXYS Integrated Circuits recommends the use of no-clean flux formulations. Board washing to reduce or remove flux residue following the solder reflow process is acceptable provided proper precautions are taken to prevent damage to the device. These precautions include but are not limited to: using a low pressure wash and providing a follow up bake cycle sufficient to remove any moisture trapped within the device due to the washing process. Due to the variability of the wash parameters used to clean the board, determination of the bake temperature and duration necessary to remove the moisture trapped within the package is the responsibility of the user (assembler). Cleaning or drying methods that employ ultrasonic energy may damage the device and should not be used. Additionally, the device must not be exposed to halide flux or solvents.



Mechanical Dimensions

LCC110

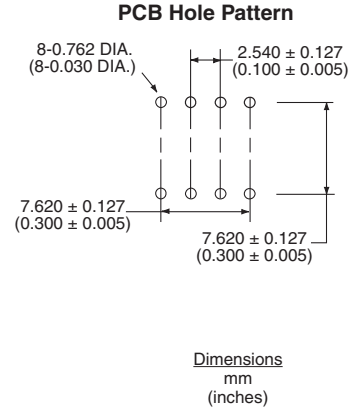
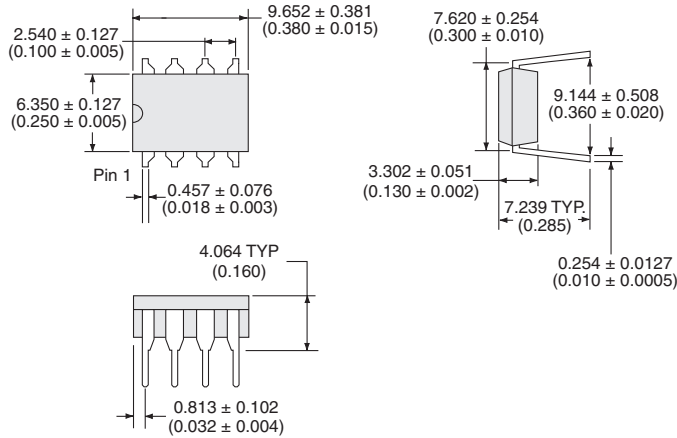

LCC110S

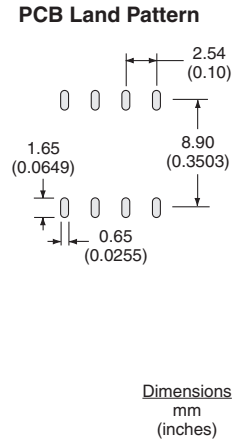
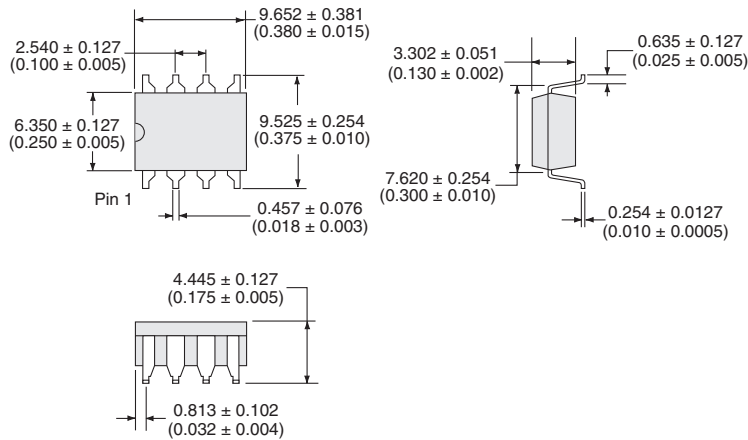

LCC110P

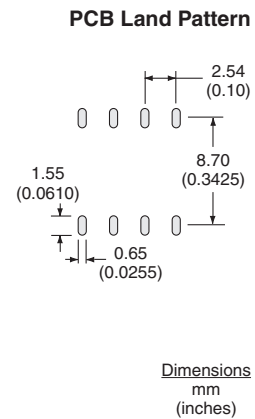
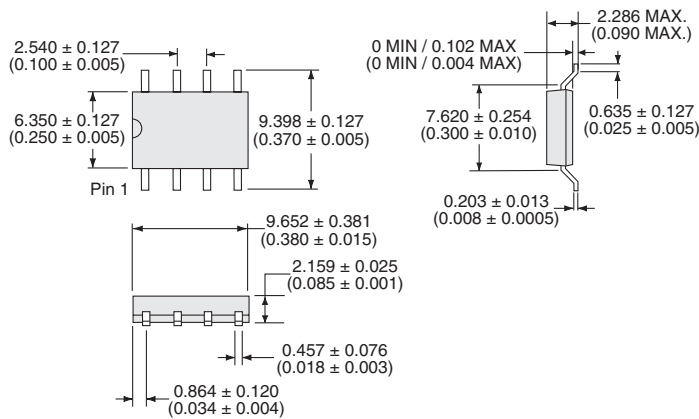

LCC110STR Tape & Reel

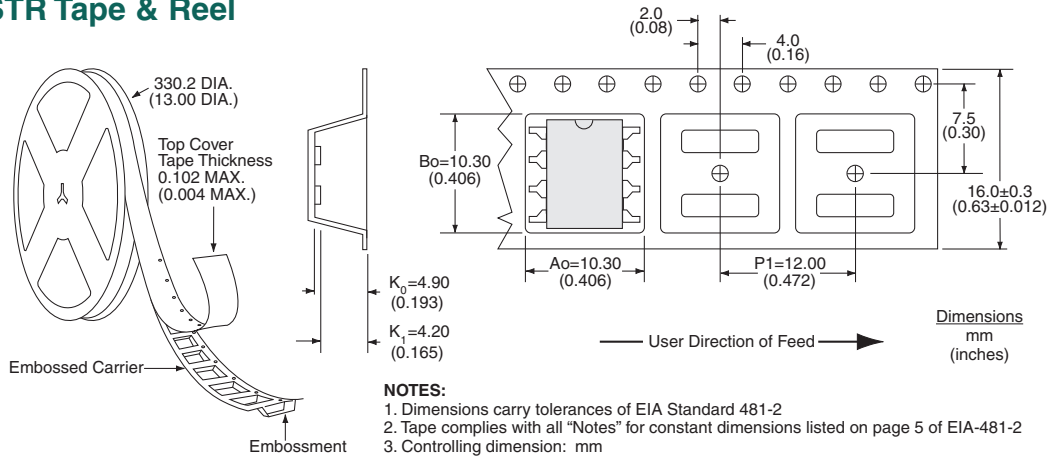

LCC110PTR Tape & Reel

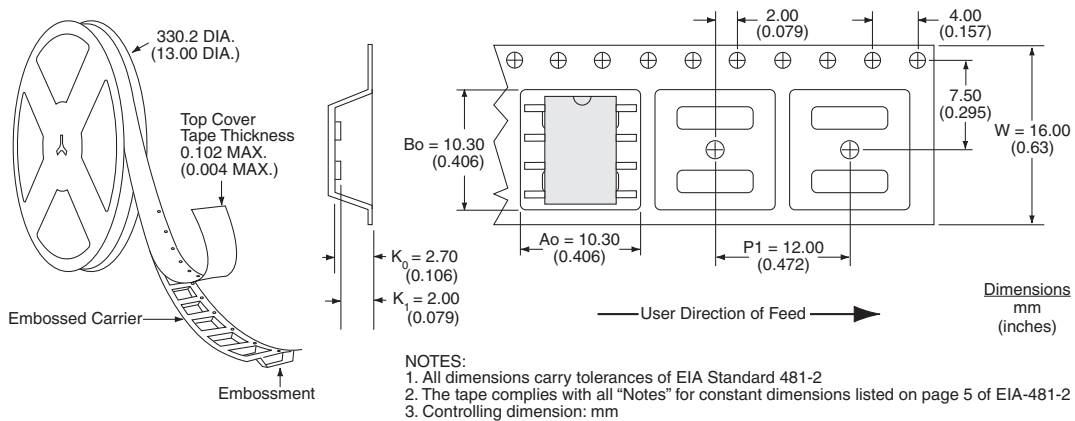

For additional information please visit our website at: <https://www.ixysic.com>

X-ON Electronics

Largest Supplier of Electrical and Electronic Components

Click to view similar products for [Solid State Relays - PCB Mount](#) category:

Click to view products by [IXYS](#) manufacturer:

Other Similar products are found below :

[M86F-2W](#) [M90F-2Y](#) [G2-1A07-ST](#) [G2-1A07-TT](#) [G2-1B02-TT](#) [G2-DA06-ST](#) [923812OCAS](#) [PLA134S](#) [DS11-1005](#) [AQH3213J](#) [AQV212J](#)
[AQY412EHAJ](#) [EFR1200480A150](#) [901-7](#) [LCA220](#) [LCB110S](#) [1618400-5](#) [SR75-1ST](#) [AQH2213AJ](#) [AQV112KLJ](#) [AQV212AJ](#) [AQV212SXJ](#)
[AQV238AD01](#) [AQW414TS](#) [AQY221N2SYD01](#) [AQY221R2VJ](#) [AQY275AXJ](#) [AQY414SXE01](#) [G2-1A02-ST](#) [G2-1A03-ST](#) [G2-1A03-TT](#)
[G2-1A05-ST](#) [G2-1A06-TT](#) [G2-1A23-TT](#) [G2-1B01-ST](#) [G2-1B01-TT](#) [G2-1B02-ST](#) [G2-DA03-ST](#) [G2-DA03-TT](#) [G2-DA06-TT](#) [CPC1333GR](#)
[3-1617776-2](#) [CTA2425](#) [TLP3131\(F\)](#) [LBA110S](#) [LBB110S](#) [LCA110LSTR](#) [LCB126S](#) [WPPM-0626D](#) [WPPM-3526D](#)