

**LSIC1MO120E0080 1200 V N-channel, Enhancement-mode SiC MOSFET** **HF** **RoHS** **Pb**

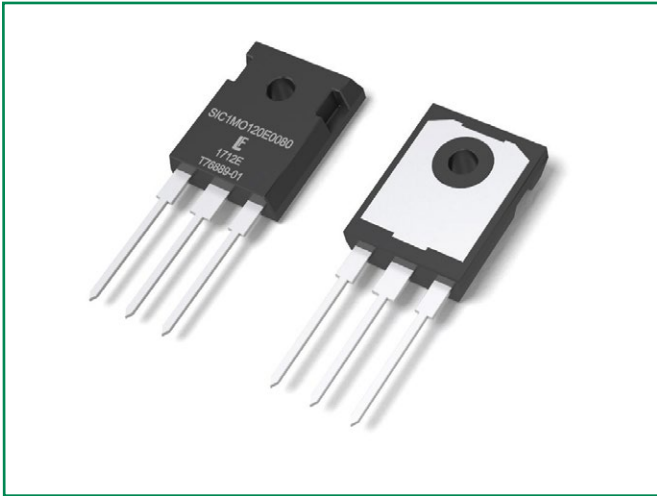

**Product Summary**

Characteristics	Value	Unit
$V_{DS}$	1200	V
Typical $R_{DS(ON)}$	80	mΩ
$I_D$ ( $T_C \leq 100\text{ }^\circ\text{C}$ )	25	A

**Circuit Diagram TO-247-3L**

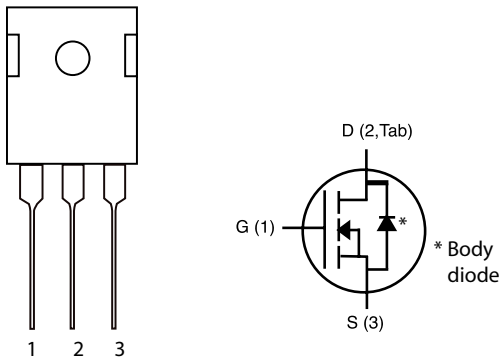

**Features**

- Optimized for high-frequency, high-efficiency applications
- Extremely low gate charge and output capacitance
- Low gate resistance for high-frequency switching
- Normally-off operation at all temperatures
- Ultra-low on-resistance

**Environmental**

- Littelfuse "RoHS" logo = **RoHS**  
RoHS conform
- Littelfuse "HF" logo = **HF**  
Halogen Free
- Littelfuse "Pb-free" logo = **Pb**  
Pb-free lead plating

**Applications**

- High-frequency applications
- Solar Inverters
- Switch Mode Power Supplies
- UPS
- Motor Drives
- High Voltage DC/DC Converters
- Battery Chargers
- Induction Heating

### Maximum Ratings

Characteristics	Symbol	Conditions	Value	Unit
Continuous Drain Current	$I_D$	$V_{GS} = 20\text{ V}, T_C = 25\text{ }^\circ\text{C}$	39	A
		$V_{GS} = 20\text{ V}, T_C = 100\text{ }^\circ\text{C}$	25	
Pulsed Drain Current <sup>1</sup>	$I_{D(pulse)}$	$T_C = 25\text{ }^\circ\text{C}$	80	A
Power Dissipation	$P_D$	$T_C = 25\text{ }^\circ\text{C}, T_J = 150\text{ }^\circ\text{C}$	179	W
Operating Junction Temperature	$T_J$		-55 to 150	$^\circ\text{C}$
Gate-source Voltage	$V_{GS,MAX}$	Absolute maximum values	-6 to 22	V
	$V_{GS,OPTR}$	Transient, <1% duty cycle	-10 to 25	
	$V_{GS,OP}$	Recommended DC operating values	-5 to 20	
Storage Temperature	$T_{STG}$	-	-55 to 150	$^\circ\text{C}$
Lead Temperature for Soldering	$T_{sold}$	-	260	$^\circ\text{C}$
Mounting Torque	$M_D$	M3 or 6-32 screw	0.6	Nm
			5.3	in-lb

Footnote 1: Pulse width limited by  $T_{J,max}$

### Thermal Characteristics

Characteristics	Symbol	Value	Unit
Maximum Thermal Resistance, junction-to-case	$R_{th,Jc,max}$	0.7	$^\circ\text{C/W}$
Maximum Thermal Resistance, junction-to-ambient	$R_{th,JA,max}$	40	$^\circ\text{C/W}$

### Electrical Characteristics ( $T_J = 25\text{ }^\circ\text{C}$ unless otherwise specified)

Characteristics	Symbol	Conditions	Min	Typ	Max	Unit
<b>Static Characteristics</b>						
Drain-source Breakdown Voltage	$V_{(BR)DSS}$	$V_{GS} = 0\text{ V}, I_D = 250\text{ }\mu\text{A}$	1200	-	-	V
Zero Gate Voltage Drain Current	$I_{DSS}$	$V_{DS} = 1200\text{ V}, V_{GS} = 0\text{ V}$	-	1	100	$\mu\text{A}$
		$V_{DS} = 1200\text{ V}, V_{GS} = 0\text{ V}, T_J = 150\text{ }^\circ\text{C}$	-	2	-	
Gate Leakage Current	$I_{GSS,F}$	$V_{GS} = 20\text{ V}, V_{DS} = 0\text{ V}$	-	-	100	nA
	$I_{GSS,R}$	$V_{GS} = -10\text{ V}, V_{DS} = 0\text{ V}$	-	-	100	
Drain-source On-state Resistance	$R_{DS(ON)}$	$I_D = 20\text{ A}, V_{GS} = 20\text{ V}$	-	80	100	m $\Omega$
		$I_D = 20\text{ A}, V_{GS} = 20\text{ V}, T_J = 150\text{ }^\circ\text{C}$	-	105	-	
Gate Threshold Voltage	$V_{GS(th)}$	$V_{DS} = V_{GS}, I_D = 10\text{ mA}$	1.8	2.8	4.0	V
		$V_{DS} = V_{GS}, I_D = 10\text{ mA}, T_J = 150\text{ }^\circ\text{C}$	-	1.9	-	
Gate Resistance	$R_G$	$f = 1\text{ MHz}, V_{AC} = 25\text{ mV}$	-	1.0	-	$\Omega$

**Electrical Characteristics** ( $T_J = 25\text{ }^\circ\text{C}$  unless otherwise specified)

Characteristics	Symbol	Conditions	Value			Unit
			Min	Typ	Max	
<b>Dynamic Characteristics</b>						
Turn-on Switching Energy	$E_{ON}$	$V_{DD} = 800\text{ V}, I_D = 20\text{ A},$ $V_{GS} = -5/+20\text{ V},$ $R_{G,ext} = 2\ \Omega, L = 1.4\text{ mH}$	-	270	-	$\mu\text{J}$
Turn-off Switching Energy	$E_{OFF}$		-	60	-	
Total Per-cycle Switching Energy	$E_{TS}$		-	330	-	
Input Capacitance	$C_{ISS}$	$V_{DD} = 800\text{ V}, V_{GS} = 0\text{ V},$ $f = 1\text{ MHz}, V_{AC} = 25\text{ mV}$	-	1825	-	$\text{pF}$
Output Capacitance	$C_{OSS}$		-	75	-	
Reverse Transfer Capacitance	$C_{RSS}$		-	15	-	
$C_{OSS}$ Stored Energy	$E_{OSS}$		-	25	-	
Total Gate Charge	$Q_g$	$V_{DD} = 800\text{ V}, I_D = 20\text{ A},$ $V_{GS} = -5/+20\text{ V}$	-	95	-	$\text{nC}$
Gate-source Charge	$Q_{gs}$		-	29	-	
Gate-drain Charge	$Q_{gd}$		-	39	-	
Turn-on Delay Time	$t_{d(on)}$	$V_{DD} = 800\text{ V}, V_{GS} = -5/+20\text{ V},$ $I_D = 20\text{ A}, R_{G,ext} = 2\ \Omega,$ $R_L = 40\ \Omega,$ Timing relative to $V_{DS}$	-	10	-	$\text{ns}$
Rise Time	$t_r$		-	10	-	
Turn-off Delay Time	$t_{d(off)}$		-	16	-	
Fall Time	$t_f$		-	6	-	

**Reverse Diode Characteristics**

Characteristics	Symbol	Conditions	Value			Unit
			Min	Typ	Max	
Diode Forward Voltage	$V_{SD}$	$I_S = 10\text{ A}, V_{GS} = 0\text{ V}$	-	3.8	-	$\text{V}$
		$I_S = 10\text{ A}, V_{GS} = 0\text{ V}, T_J = 150\text{ }^\circ\text{C}$	-	3.4	-	
Continuous Diode Forward Current	$I_S$	$V_{GS} = 0\text{ V}, T_C = 25\text{ }^\circ\text{C}$	-	-	35	$\text{A}$
Peak Diode Forward Current <sup>1</sup>	$I_{SP}$		-	-	85	
Reverse Recovery Time	$t_{rr}$	$V_{GS} = -5\text{ V}, I_S = 20\text{ A},$ $V_R = 800\text{ V},$ $di/dt = 5.3\text{ A/ns}$	-	25	-	$\text{ns}$
Reverse Recovery Charge	$Q_{rr}$		-	185	-	$\text{nC}$
Peak Reverse Recovery Current	$I_{rrm}$		-	16	-	$\text{A}$

Footnote 1: Pulse width limited by  $T_{J,max}$

**Figure 1: Maximum Power Dissipation ( $T_j = 150^\circ\text{C}$ )**

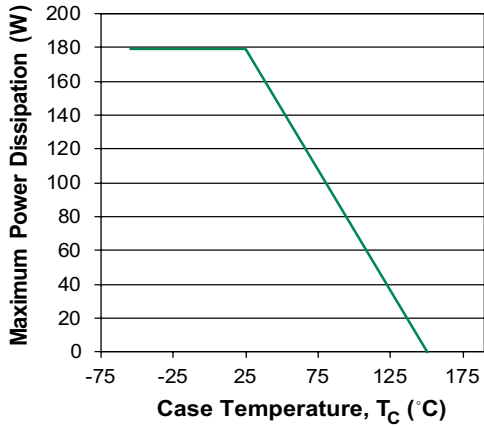

**Figure 2: Transfer Characteristics ( $V_{DS} = 10\text{V}$ )**

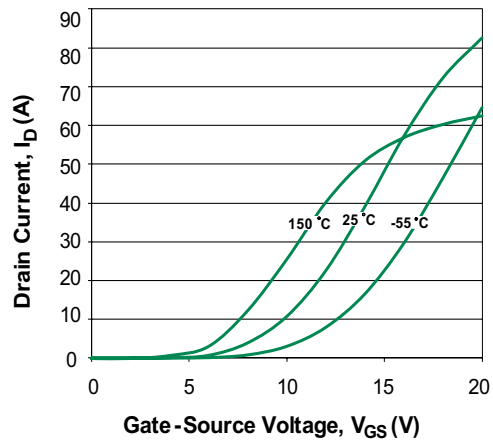

**Figure 3: Output Characteristics ( $T_j = 25^\circ\text{C}$ )**

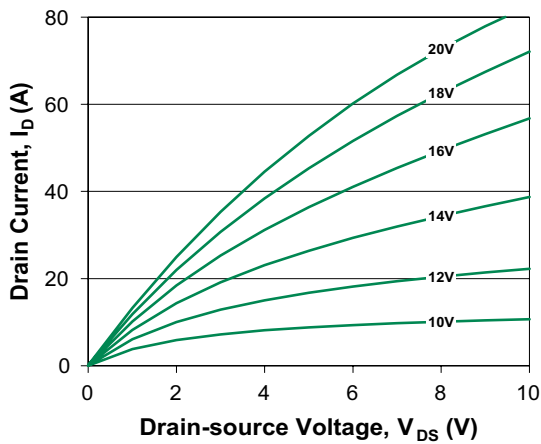

**Figure 4: Output Characteristics ( $T_j = 150^\circ\text{C}$ )**

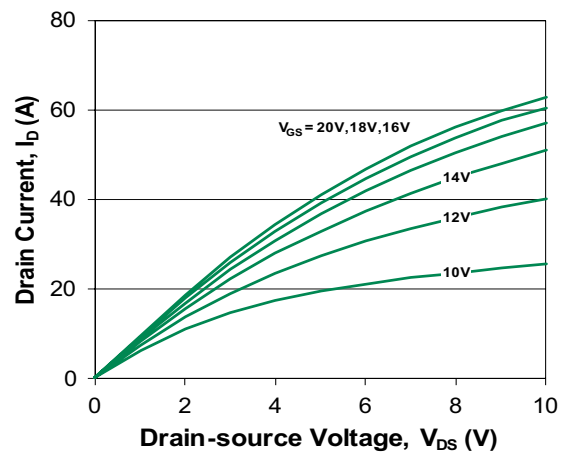

**Figure 5: Output Characteristics ( $T_j = -55^\circ\text{C}$ )**

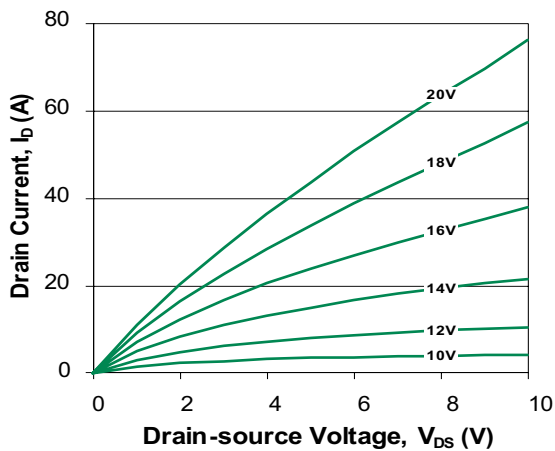

**Figure 6: Reverse Conduction Characteristics ( $T_j = 25^\circ\text{C}$ )**

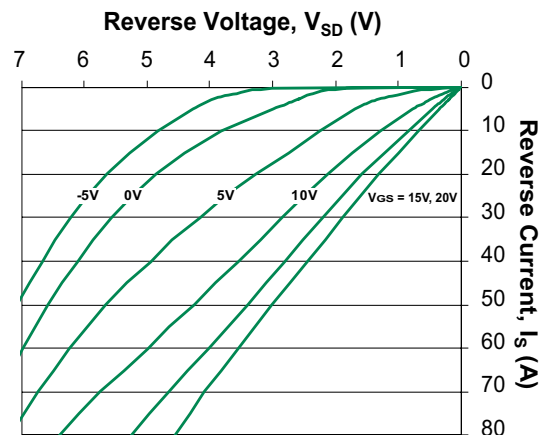

Figure 7: Reverse Conduction Characteristics ( $T_J = 150^\circ\text{C}$ )

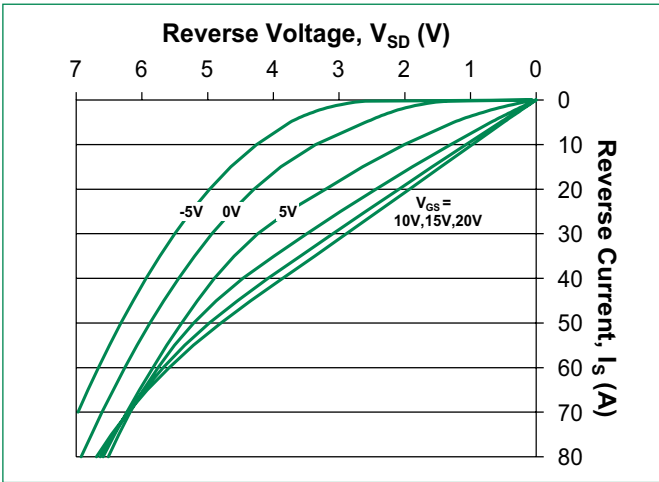

Figure 8: Reverse Conduction Characteristics ( $T_J = -55^\circ\text{C}$ )

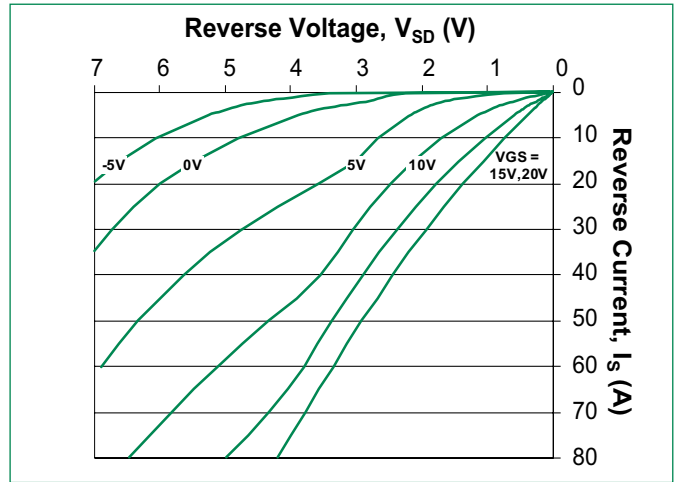

Figure 9: Transient Thermal Impedance

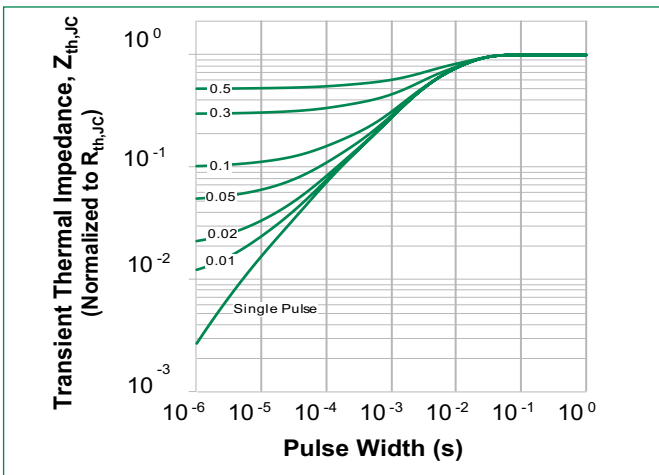

Figure 10: Safe Operating Area ( $T_C = 25^\circ\text{C}$ )

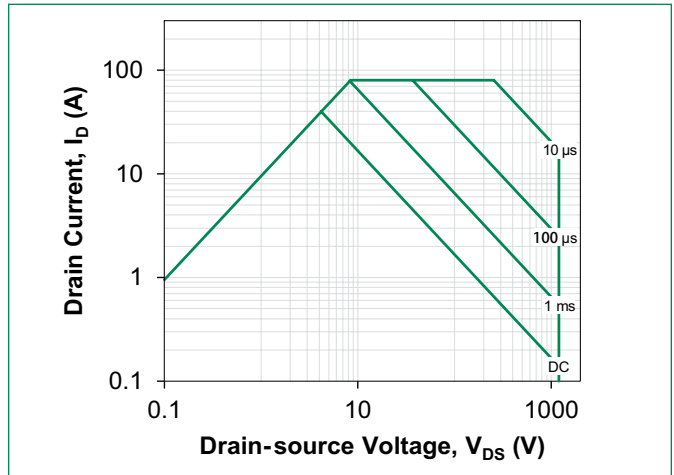

Figure 11: On-resistance vs. Drain Current

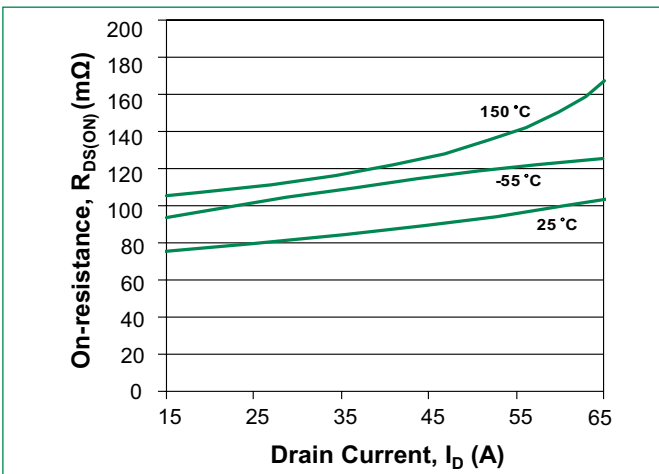
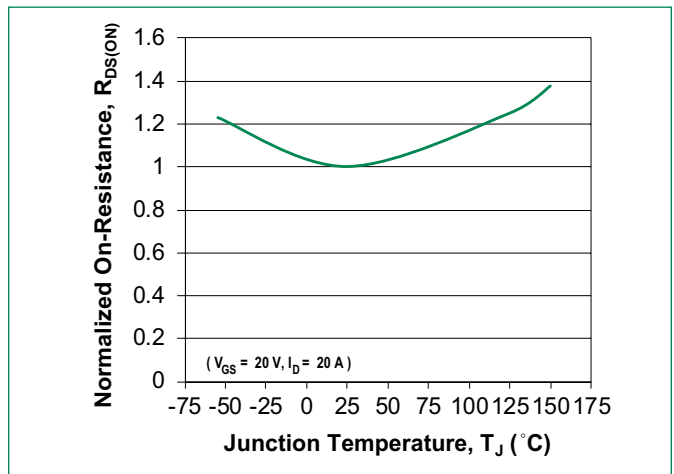
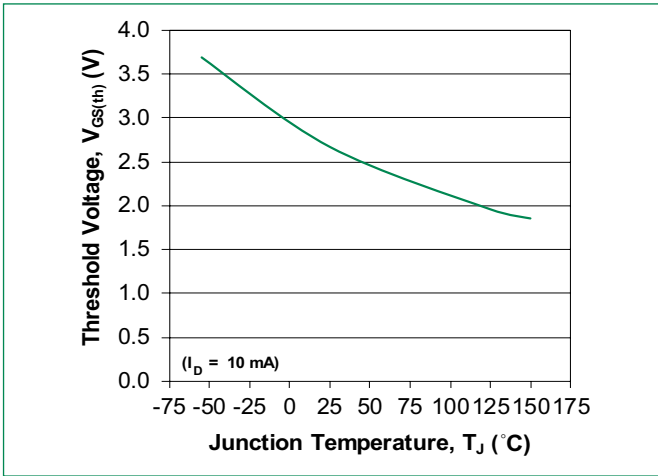

Figure 12: Normalized On-resistance



**Figure 13: Threshold Voltage**



**Figure 14: Drain-source Blocking Voltage**

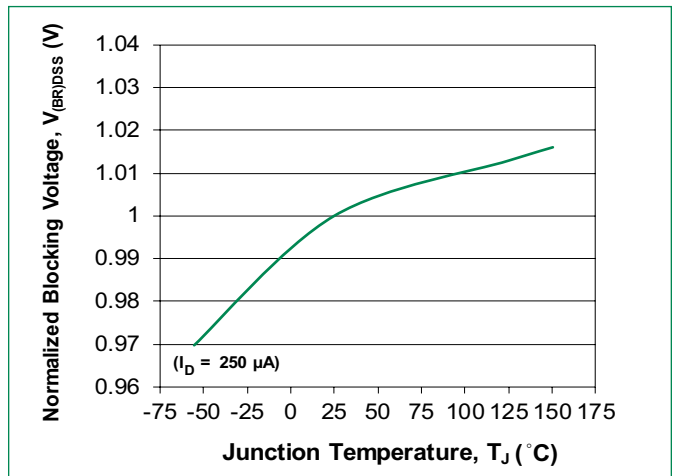

**Figure 15: Junction Capacitances**

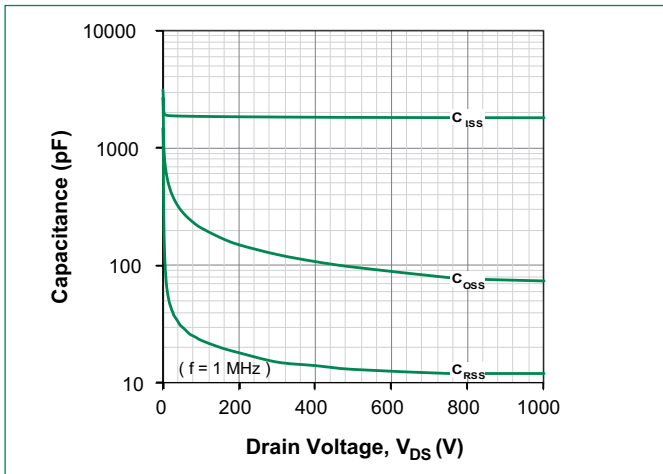

**Figure 16: Junction Capacitances**

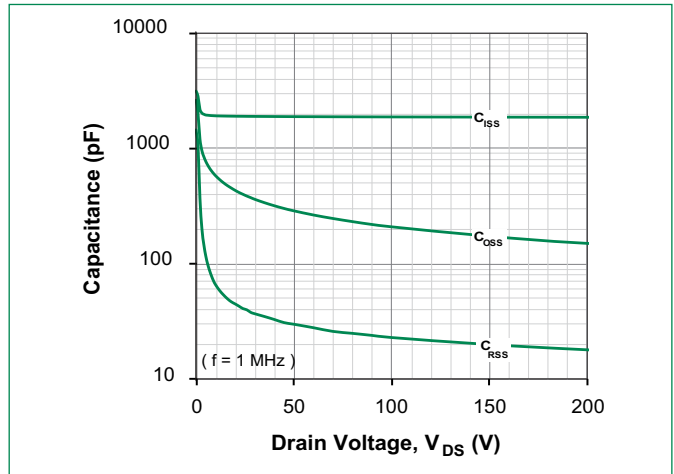

**Figure 17:  $C_{oss}$  Stored Energy  $E_{oss}$**

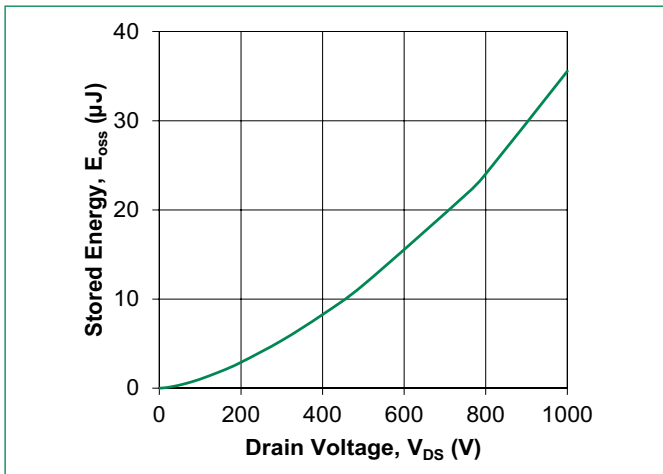

**Figure 18: Gate Charge**

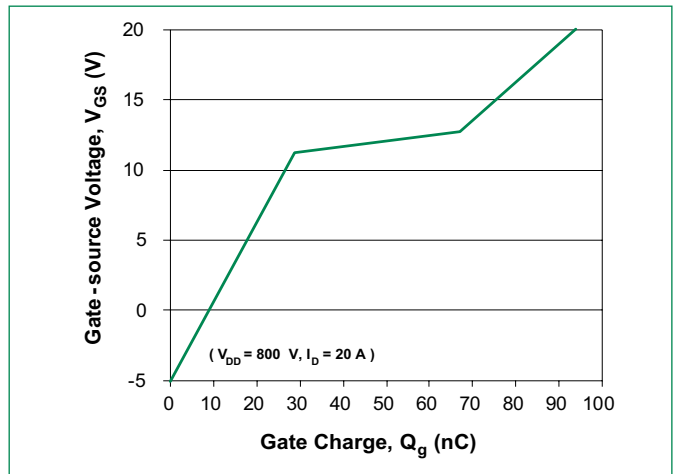

Figure 19: Switching Energy vs. Drain Current

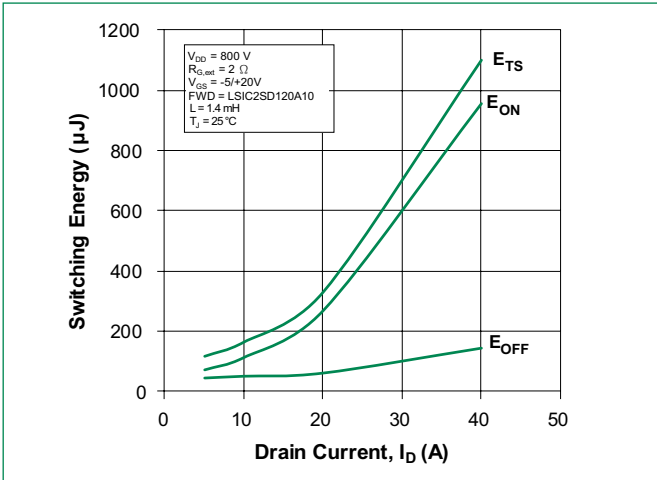
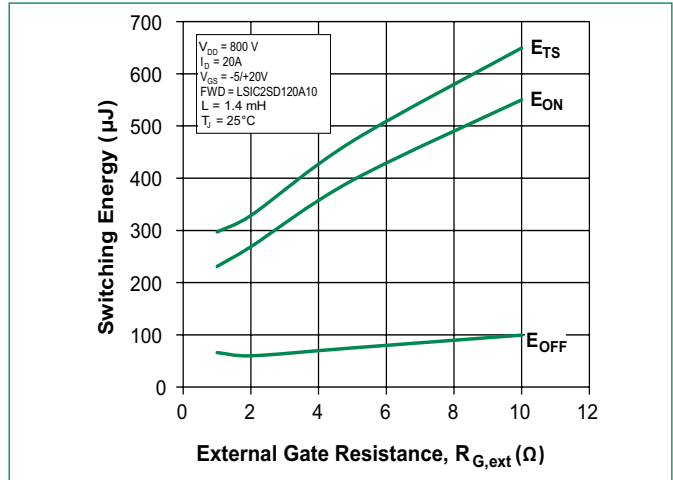
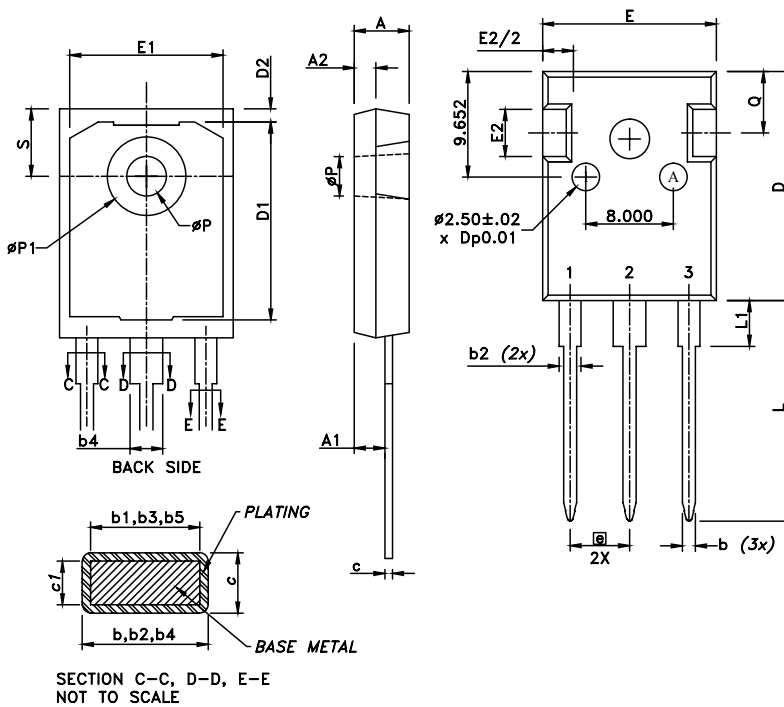

Figure 20: Switching Energy vs. Gate Resistance



Package Dimensions TO-247-3L



SECTION C-C, D-D, E-E  
NOT TO SCALE

Recommended Hole Pattern Layout

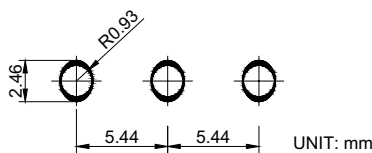

- Notes:
1. Dimensions are in millimeters
  2. Dimension D, E do not include mold flash. Mold flash shall not exceed 0.127 mm per side measured at outer most extreme of plastic body.
  3. øP to have a maximum draft angle of 38.1 mm to the top of the part with a maximum hole diameter of 3.912 mm.

Symbol	Millimeters		
	Min	Nom	Max
A	4.902	5.029	5.156
A1	2.253	2.380	2.507
A2	1.854	1.981	2.108
D	20.828	20.955	21.082
E	15.773	15.900	16.027
E2	4.191	4.318	4.445
E2/2	1.473	1.524	1.575
e	5.436		
L	20.066	20.193	20.320
L1	3.937	4.191	4.445
øP	3.556	3.067	3.658
Q	5.486	5.613	5.740
S	6.045	6.172	6.299
b	0.991	-	1.397
b1	0.991	1.199	1.346
b2	1.651	-	2.387
b3	1.651	1.999	2.336
b4	2.591	-	3.429
b5	2.591	3.000	3.378
c	0.381	0.635	0.889
c1	0.381	0.610	0.838
D1	17.399	17.526	17.653
D2	1.067	1.194	1.321
E1	13.894	14.021	14.148
øP1	7.061	7.188	7.315

**Part Numbering and Marking System**

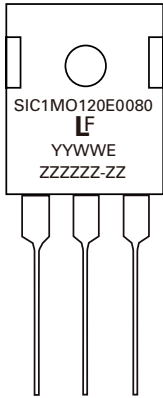

**SIC** = SiC  
**1** = Gen1  
**MO** = MOSFET  
**120** = Voltage Rating (1200 V)  
**E** = TO-247-3L  
**0080** =  $R_{DS(ON)}$  (80 mOhm)  
**YY** = Year  
**WW** = Week  
**E** = Special Code  
**ZZZZZZ-ZZ** = Lot Number

**Packing Options**

Part Number	Marking	Packing Mode	M.O.Q
LSIC1MO120E0080	SIC1MO120E0080	Tube(30pcs)	450

**Packing Specification TO-247-3L**

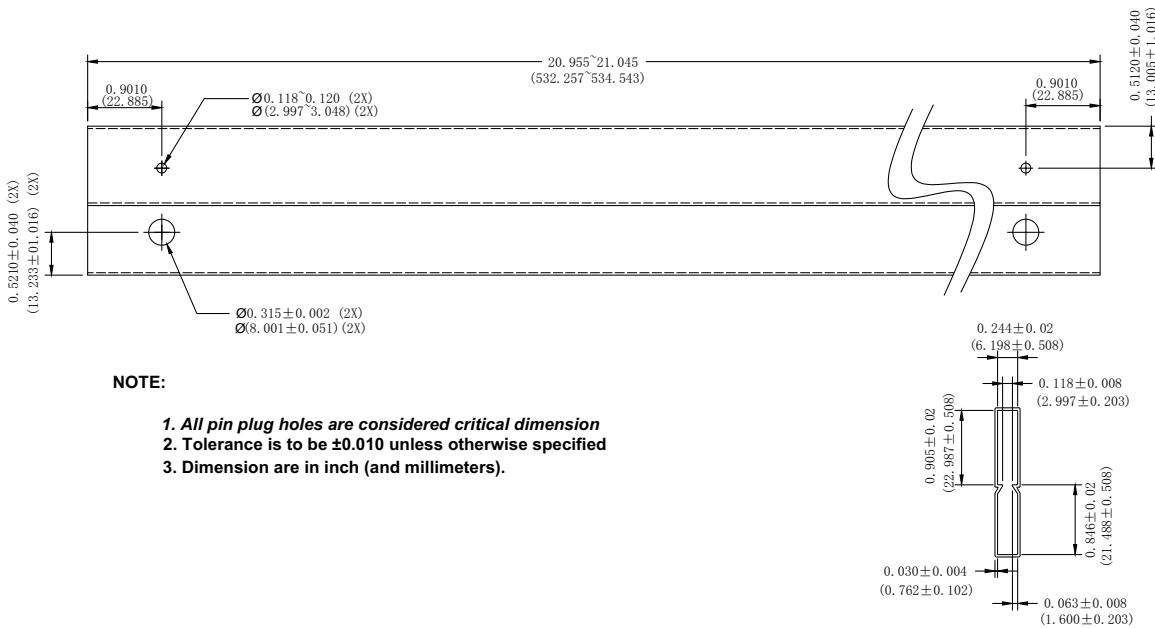

**Disclaimer Notice** - Littelfuse products are not designed for, and shall not be used for, any purpose (including, without limitation, automotive, military, aerospace, medical, life-saving, life-sustaining or nuclear facility applications, devices intended for surgical implant into the body, or any other application in which the failure or lack of desired operation of the product may result in personal injury, death, or property damage) other than those expressly set forth in applicable Littelfuse product documentation. Warranties granted by Littelfuse shall be deemed void for products used for any purpose not expressly set forth in applicable Littelfuse documentation. Littelfuse shall not be liable for any claims or damages arising out of products used in applications not expressly intended by Littelfuse as set forth in applicable Littelfuse documentation. The sale and use of Littelfuse products is subject to Littelfuse Terms and Conditions of Sale, unless otherwise agreed by Littelfuse. Information furnished is believed to be accurate and reliable. However, users should independently evaluate the suitability of and test each product selected for their own applications. Littelfuse products are not designed for, and may not be used in, all applications. Read complete Disclaimer Notice at [www.littelfuse.com/disclaimer-electronics](http://www.littelfuse.com/disclaimer-electronics).



## X-ON Electronics

Largest Supplier of Electrical and Electronic Components

*Click to view similar products for [MOSFET](#) category:*

*Click to view products by [IXYS](#) manufacturer:*

Other Similar products are found below :

[614233C](#) [648584F](#) [MCH3443-TL-E](#) [MCH6422-TL-E](#) [FDPF9N50NZ](#) [FW216A-TL-2W](#) [FW231A-TL-E](#) [APT5010JVR](#) [NTNS3A92PZT5G](#)  
[IRF100S201](#) [JANTX2N5237](#) [2SK2464-TL-E](#) [2SK3818-DL-E](#) [FCA20N60\\_F109](#) [FDZ595PZ](#) [STD6600NT4G](#) [FSS804-TL-E](#) [2SJ277-DL-E](#)  
[2SK1691-DL-E](#) [2SK2545\(Q,T\)](#) [D2294UK](#) [405094E](#) [423220D](#) [MCH6646-TL-E](#) [TPCC8103,L1Q\(CM](#) [367-8430-0972-503](#) [VN1206L](#)  
[424134F](#) [026935X](#) [051075F](#) [SBVS138LT1G](#) [614234A](#) [715780A](#) [NTNS3166NZT5G](#) [751625C](#) [873612G](#) [IRF7380TRHR](#)  
[IPS70R2K0CEAKMA1](#) [RJK60S3DPP-E0#T2](#) [RJK60S5DPK-M0#T0](#) [APT5010JVFR](#) [APT12031JFLL](#) [APT12040JVR](#) [DMN3404LQ-7](#)  
[NTE6400](#) [JANTX2N6796U](#) [JANTX2N6784U](#) [JANTXV2N5416U4](#) [SQM110N05-06L-GE3](#) [SIHF35N60E-GE3](#)