

Fast Recovery Epitaxial Diode (FRED) Module

MEA 95-06 DA
MEK 95-06 DA
MEE 95-06 DA

V_{RRM} = 600 V
I_{FAV} = 95 A
t_{rr} = 250 ns

V _{RSM} V	V _{RRM} V	Type						
600	600	<table border="0"> <tr> <td>MEA95-06 DA</td> <td>MEK 95-06 DA</td> <td>MEE 95-06 DA</td> </tr> <tr> <td></td> <td></td> <td></td> </tr> </table>	MEA95-06 DA	MEK 95-06 DA	MEE 95-06 DA			
MEA95-06 DA	MEK 95-06 DA	MEE 95-06 DA						

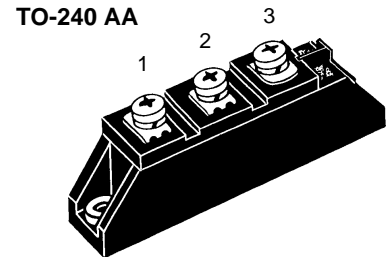

Symbol	Test Conditions	Maximum Ratings
I _{FRMS}	T _{case} = 75°C	142 A
I _{FAV} ①	T _{case} = 75°C; rectangular, d = 0.5	95 A
I _{FRM}	t _p < 10 μs; rep. rating, pulse width limited by T _{VJM}	TBD A
I _{FSM}	T _{VJ} = 45°C; t = 10 ms (50 Hz), sine	1200 A
	t = 8.3 ms (60 Hz), sine	1300 A
	T _{VJ} = 150°C; t = 10 ms (50 Hz), sine	1080 A
	t = 8.3 ms (60 Hz), sine	1170 A
I ² t	T _{VJ} = 45°C; t = 10 ms (50 Hz), sine	7200 A ² s
	t = 8.3 ms (60 Hz), sine	7100 A ² s
	T _{VJ} = 150°C; t = 10 ms (50 Hz), sine	5800 A ² s
	t = 8.3 ms (60 Hz), sine	5700 A ² s
T _{VJ}		-40...+150 °C
T _{stg}		-40...+125 °C
T _{Hmax}		110 °C
P _{tot}	T _{case} = 25°C	280 W
V _{ISOL}	50/60 Hz, RMS t = 1 min	3000 V~
	I _{ISOL} ≤ 1 mA t = 1 s	3600 V~
M _d	Mounting torque (M5)	2.5-4/22-35 Nm/lb.in.
	Terminal connection torque (M5)	2.5-4/22-35 Nm/lb.in.
d _s	Creep distance on surface	12.7 mm
d _A	Strike distance through air	9.6 mm
a	Maximum allowable acceleration	50 m/s ²
Weight		90 g

Features

- International standard package with DCB ceramic base plate
- Planar passivated chips
- Short recovery time
- Low switching losses
- Soft recovery behaviour
- Isolation voltage 3600 V~
- UL registered E 72873

Applications

- Antiparallel diode for high frequency switching devices
- Free wheeling diode in converters and motor control circuits
- Inductive heating and melting
- Uninterruptible power supplies (UPS)
- Ultrasonic cleaners and welders

Advantages

- High reliability circuit operation
- Low voltage peaks for reduced protection circuits
- Low noise switching
- Low losses

Dimensions in mm (1 mm = 0.0394")

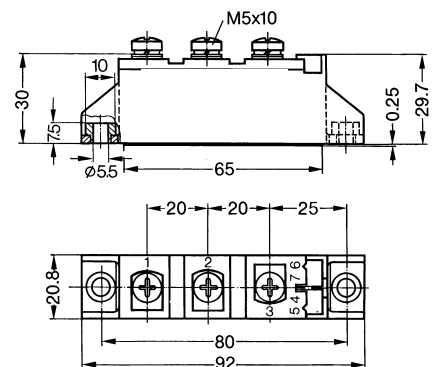

① I_{FAV} rating includes reverse blocking losses at T_{VJM}, V_R = 0.6 V_{RRM}, duty cycle d = 0.5
Data according to IEC 60747
IXYS reserves the right to change limits, test conditions and dimensions

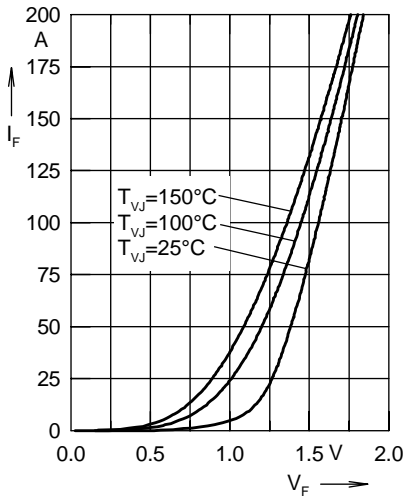

Fig. 1 Forward current I_F versus voltage drop V_F per leg

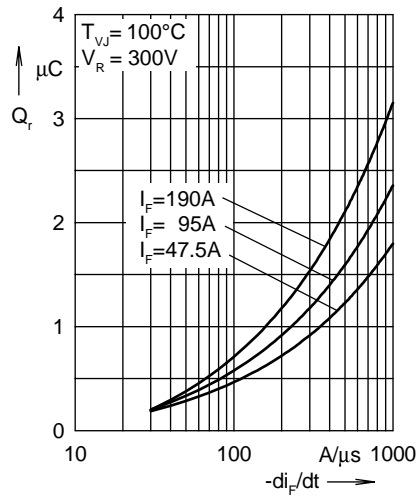

Fig. 2 Reverse recovery charge Q_r versus $-di_F/dt$

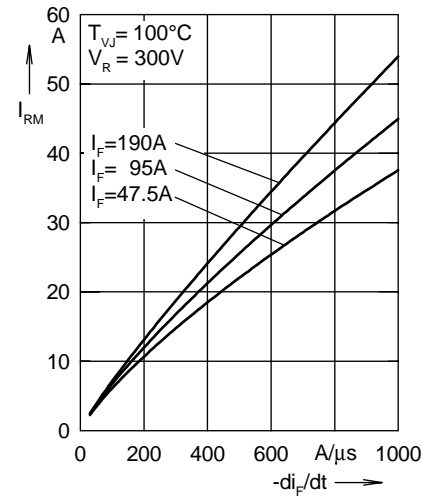

Fig. 3 Peak reverse current I_{RM} versus $-di_F/dt$

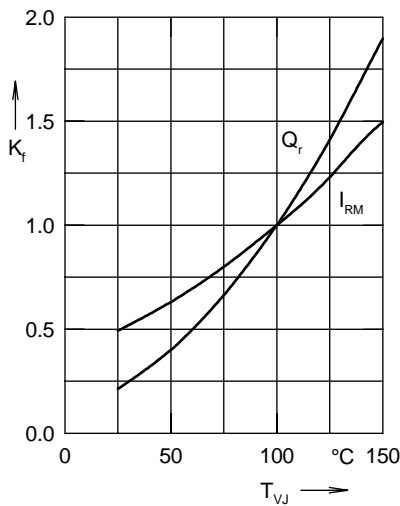

Fig. 4 Dynamic parameters Q_r , I_{RM} versus junction temperature T_{VJ}

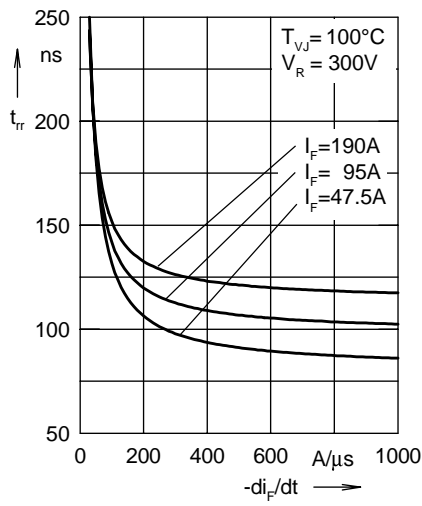

Fig. 5 Recovery time t_{rr} versus $-di_F/dt$

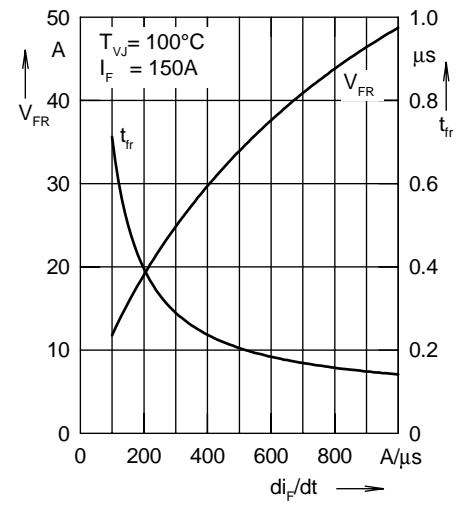

Fig. 6 Peak forward voltage V_{FR} and t_{fr} versus di_F/dt

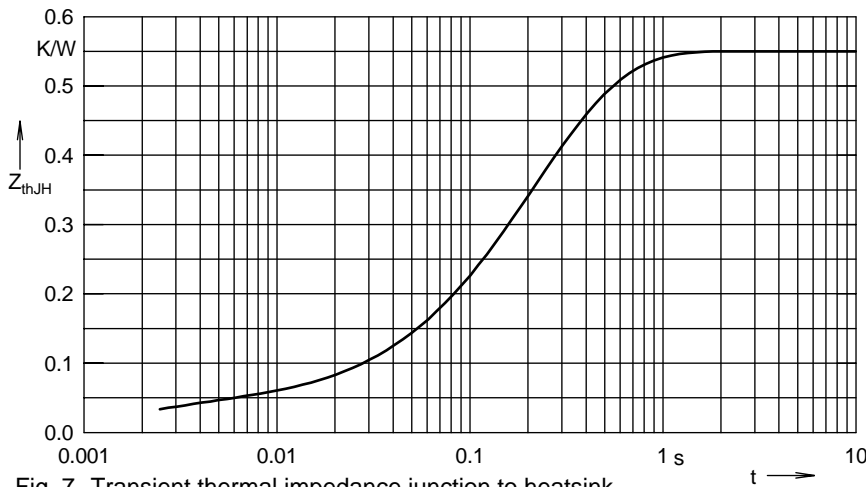

Fig. 7 Transient thermal impedance junction to heatsink

Constants for Z_{thJH} calculation:

i	R_{thi} (K/W)	t_i (s)
1	0.037	0.002
2	0.138	0.134
3	0.093	0.25
4	0.282	0.274

X-ON Electronics

Largest Supplier of Electrical and Electronic Components

Click to view similar products for [Discrete Semiconductor Modules](#) category:

Click to view products by [IXYS](#) manufacturer:

Other Similar products are found below :

[M252511FV](#) [DD260N12K-A](#) [DD380N16A](#) [DD89N1600K-A](#) [APT2X21DC60J](#) [APT58M80J](#) [B522F-2-YEC](#) [MSTC90-16](#) [25.163.0653.1](#)
[25.163.2453.0](#) [25.163.4253.0](#) [25.190.2053.0](#) [25.194.3453.0](#) [25.320.4853.1](#) [25.320.5253.1](#) [25.326.3253.1](#) [25.326.3553.1](#) [25.330.1653.1](#)
[25.330.4753.1](#) [25.330.5253.1](#) [25.334.3253.1](#) [25.334.3353.1](#) [25.350.2053.0](#) [25.352.4753.1](#) [25.522.3253.0](#) [T483C](#) [T484C](#) [T485F](#) [T485H](#)
[T512F-YEB](#) [T513F](#) [T514F](#) [T554](#) [T612FSE](#) [25.161.3453.0](#) [25.179.2253.0](#) [25.194.3253.0](#) [25.325.1253.1](#) [25.326.4253.1](#) [25.330.0953.1](#)
[25.332.4353.1](#) [25.350.1653.0](#) [25.350.2453.0](#) [25.352.1453.0](#) [25.352.1653.0](#) [25.352.2453.0](#) [25.352.5453.1](#) [25.522.3353.0](#) [25.602.4053.0](#)
[25.640.5053.0](#)