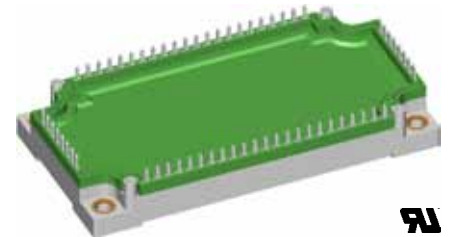
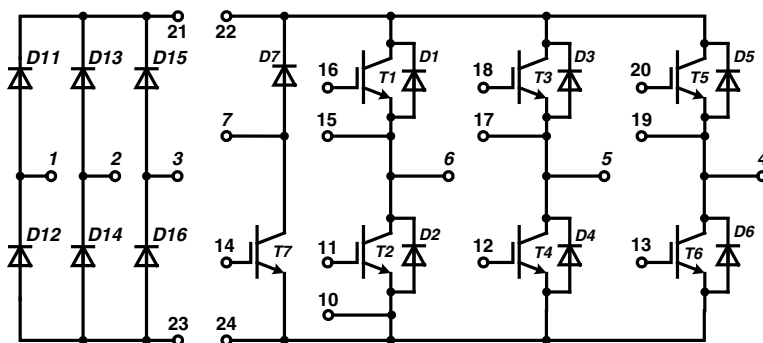


# Converter - Brake - Inverter Module XPT IGBT

| Three Phase Rectifier      | Brake Chopper                 | Three Phase Inverter          |
|----------------------------|-------------------------------|-------------------------------|
| $V_{RRM} = 1600 \text{ V}$ | $V_{CES} = 1200 \text{ V}$    | $V_{CES} = 1200 \text{ V}$    |
| $I_{DAVM} = 190 \text{ A}$ | $I_{C25} = 60 \text{ A}$      | $I_{C25} = 85 \text{ A}$      |
| $I_{FSM} = 700 \text{ A}$  | $V_{CE(sat)} = 1.8 \text{ V}$ | $V_{CE(sat)} = 1.8 \text{ V}$ |

**Part name** (Marking on product)

MIXA60WB1200TEH



E 72873

Pin configuration see outlines.

### Features:

- Easy paralleling due to the positive temperature coefficient of the on-state voltage
- Rugged XPT design (Xtreme light Punch Through) results in:
  - short circuit rated for 10  $\mu\text{sec}$ .
  - very low gate charge
  - square RBSOA @ 3x  $I_C$
  - low EMI
- Thin wafer technology combined with the XPT design results in a competitive low  $V_{CE(sat)}$
- SONIC™ diode
  - fast and soft reverse recovery
  - low operating forward voltage

### Application:

- AC motor drives
- Solar inverter
- Medical equipment
- Uninterruptible power supply
- Air-conditioning systems
- Welding equipment
- Switched-mode and resonant-mode power supplies

### Package:

- "E3-Pack" standard outline
- Insulated copper base plate
- Soldering pins for PCB mounting
- Temperature sense included

**Output Inverter T1 - T6**

| Symbol        | Definitions                           | Conditions                                                                                                   | Ratings                                                         |            |          | Unit          |          |
|---------------|---------------------------------------|--------------------------------------------------------------------------------------------------------------|-----------------------------------------------------------------|------------|----------|---------------|----------|
|               |                                       |                                                                                                              | min.                                                            | typ.       | max.     |               |          |
| $V_{CES}$     | collector emitter voltage             |                                                                                                              | $T_{VJ} = 25^{\circ}\text{C}$                                   |            | 1200     | V             |          |
| $V_{GES}$     | max. DC gate voltage                  | continuous                                                                                                   |                                                                 |            | $\pm 20$ | V             |          |
| $V_{GEM}$     | max. transient collector gate voltage | transient                                                                                                    |                                                                 |            | $\pm 30$ | V             |          |
| $I_{C25}$     | collector current                     |                                                                                                              | $T_C = 25^{\circ}\text{C}$                                      |            | 85       | A             |          |
| $I_{C80}$     |                                       |                                                                                                              | $T_C = 80^{\circ}\text{C}$                                      |            | 60       | A             |          |
| $P_{tot}$     | total power dissipation               |                                                                                                              | $T_C = 25^{\circ}\text{C}$                                      |            | 290      | W             |          |
| $V_{CE(sat)}$ | collector emitter saturation voltage  | $I_C = 55\text{ A}; V_{GE} = 15\text{ V}$                                                                    | $T_{VJ} = 25^{\circ}\text{C}$<br>$T_{VJ} = 125^{\circ}\text{C}$ | 1.8<br>2.1 | 2.1      | V<br>V        |          |
| $V_{GE(th)}$  | gate emitter threshold voltage        | $I_C = 2\text{ mA}; V_{GE} = V_{CE}$                                                                         | $T_{VJ} = 25^{\circ}\text{C}$                                   | 5.4        | 6.0      | 6.5           | V        |
| $I_{CES}$     | collector emitter leakage current     | $V_{CE} = V_{CES}; V_{GE} = 0\text{ V}$                                                                      | $T_{VJ} = 25^{\circ}\text{C}$<br>$T_{VJ} = 125^{\circ}\text{C}$ |            | 0.2      | 0.5           | mA<br>mA |
| $I_{GES}$     | gate emitter leakage current          | $V_{GE} = \pm 20\text{ V}$                                                                                   |                                                                 |            | 500      | nA            |          |
| $Q_{G(on)}$   | total gate charge                     | $V_{CE} = 600\text{ V}; V_{GE} = 15\text{ V}; I_C = 50\text{ A}$                                             |                                                                 |            | 165      | nC            |          |
| $t_{d(on)}$   | turn-on delay time                    | inductive load<br>$V_{CE} = 600\text{ V}; I_C = 50\text{ A}$<br>$V_{GE} = \pm 15\text{ V}; R_G = 15\ \Omega$ | $T_{VJ} = 125^{\circ}\text{C}$                                  |            | 70       | ns            |          |
| $t_r$         | current rise time                     |                                                                                                              |                                                                 |            | 40       | ns            |          |
| $t_{d(off)}$  | turn-off delay time                   |                                                                                                              |                                                                 |            | 250      | ns            |          |
| $t_f$         | current fall time                     |                                                                                                              |                                                                 |            | 100      | ns            |          |
| $E_{on}$      | turn-on energy per pulse              |                                                                                                              |                                                                 |            | 4.5      | mJ            |          |
| $E_{off}$     | turn-off energy per pulse             |                                                                                                              |                                                                 |            | 5.5      | mJ            |          |
| <b>RBSOA</b>  | reverse bias safe operating area      | $V_{GE} = \pm 15\text{ V}; R_G = 15\ \Omega;$                                                                | $T_{VJ} = 125^{\circ}\text{C}$<br>$V_{CEK} = 1200\text{ V}$     |            | 150      | A             |          |
| <b>SCSOA</b>  | short circuit safe operating area     |                                                                                                              | $T_{VJ} = 125^{\circ}\text{C}$                                  |            | 10       | $\mu\text{s}$ |          |
| $t_{SC}$      | short circuit duration                | $V_{CE} = 900\text{ V}; V_{GE} = \pm 15\text{ V};$                                                           |                                                                 |            | 200      | A             |          |
| $I_{SC}$      | short circuit current                 | $R_G = 15\ \Omega;$ non-repetitive                                                                           |                                                                 |            |          |               |          |
| $R_{thJC}$    | thermal resistance junction to case   | (per IGBT)                                                                                                   |                                                                 |            | 0.43     | K/W           |          |

**Output Inverter D1 - D6**

| Symbol     | Definitions                         | Conditions                                                                                                 | Ratings                                                         |              |      | Unit          |
|------------|-------------------------------------|------------------------------------------------------------------------------------------------------------|-----------------------------------------------------------------|--------------|------|---------------|
|            |                                     |                                                                                                            | min.                                                            | typ.         | max. |               |
| $V_{RRM}$  | max. repetitive reverse voltage     |                                                                                                            | $T_{VJ} = 25^{\circ}\text{C}$                                   |              | 1200 | V             |
| $I_{F25}$  | forward current                     |                                                                                                            | $T_C = 25^{\circ}\text{C}$                                      |              | 88   | A             |
| $I_{F80}$  |                                     |                                                                                                            | $T_C = 80^{\circ}\text{C}$                                      |              | 59   | A             |
| $V_F$      | forward voltage                     | $I_F = 60\text{ A}; V_{GE} = 0\text{ V}$                                                                   | $T_{VJ} = 25^{\circ}\text{C}$<br>$T_{VJ} = 125^{\circ}\text{C}$ | 1.95<br>1.95 | 2.2  | V<br>V        |
| $Q_{rr}$   | reverse recovery charge             | $V_R = 600\text{ V}$<br>$di_F/dt = -1200\text{ A}/\mu\text{s}$<br>$I_F = 60\text{ A}; V_{GE} = 0\text{ V}$ | $T_{VJ} = 125^{\circ}\text{C}$                                  |              | 8    | $\mu\text{C}$ |
| $I_{RM}$   | max. reverse recovery current       |                                                                                                            |                                                                 |              | 60   | A             |
| $t_{rr}$   | reverse recovery time               |                                                                                                            |                                                                 |              | 350  | ns            |
| $E_{rec}$  | reverse recovery energy             |                                                                                                            |                                                                 |              | 2.5  | mJ            |
| $R_{thJC}$ | thermal resistance junction to case | (per diode)                                                                                                |                                                                 |              | 0.6  | K/W           |

 $T_C = 25^{\circ}\text{C}$  unless otherwise stated

**Brake T7**

| Symbol        | Definitions                           | Conditions                                                                                                   | Ratings                                                         |      |            | Unit   |               |
|---------------|---------------------------------------|--------------------------------------------------------------------------------------------------------------|-----------------------------------------------------------------|------|------------|--------|---------------|
|               |                                       |                                                                                                              | min.                                                            | typ. | max.       |        |               |
| $V_{CES}$     | collector emitter voltage             | $T_{VJ} = 25^{\circ}\text{C}$                                                                                |                                                                 |      | 1200       | V      |               |
| $V_{GES}$     | max. DC gate voltage                  | continuous                                                                                                   |                                                                 |      | $\pm 20$   | V      |               |
| $V_{GEM}$     | max. transient collector gate voltage | transient                                                                                                    |                                                                 |      | $\pm 30$   | V      |               |
| $I_{C25}$     | collector current                     | $T_C = 25^{\circ}\text{C}$                                                                                   |                                                                 |      | 60         | A      |               |
| $I_{C80}$     |                                       | $T_C = 80^{\circ}\text{C}$                                                                                   |                                                                 |      | 40         | A      |               |
| $P_{tot}$     | total power dissipation               | $T_C = 25^{\circ}\text{C}$                                                                                   |                                                                 |      | 200        | W      |               |
| $V_{CE(sat)}$ | collector emitter saturation voltage  | $I_C = 35\text{ A}; V_{GE} = 15\text{ V}$                                                                    |                                                                 |      | 1.8<br>2.1 | V<br>V |               |
| $V_{GE(th)}$  | gate emitter threshold voltage        | $I_C = 1.5\text{ mA}; V_{GE} = V_{CE}$                                                                       | $T_{VJ} = 25^{\circ}\text{C}$                                   | 5.4  | 6.0        | 6.5    | V             |
| $I_{CES}$     | collector emitter leakage current     | $V_{CE} = V_{CES}; V_{GE} = 0\text{ V}$                                                                      | $T_{VJ} = 25^{\circ}\text{C}$<br>$T_{VJ} = 125^{\circ}\text{C}$ |      | 0.1        | 0.5    | mA<br>mA      |
| $I_{GES}$     | gate emitter leakage current          | $V_{GE} = \pm 20\text{ V}$                                                                                   |                                                                 |      |            | 500    | nA            |
| $Q_{G(on)}$   | total gate charge                     | $V_{CE} = 600\text{ V}; V_{GE} = 15\text{ V}; I_C = 35\text{ A}$                                             |                                                                 |      | 107        |        | nC            |
| $t_{d(on)}$   | turn-on delay time                    | inductive load<br>$V_{CE} = 600\text{ V}; I_C = 35\text{ A}$<br>$V_{GE} = \pm 15\text{ V}; R_G = 27\ \Omega$ | $T_{VJ} = 125^{\circ}\text{C}$                                  |      | 70         |        | ns            |
| $t_r$         | current rise time                     |                                                                                                              |                                                                 |      | 40         |        | ns            |
| $t_{d(off)}$  | turn-off delay time                   |                                                                                                              |                                                                 |      | 250        |        | ns            |
| $t_f$         | current fall time                     |                                                                                                              |                                                                 |      | 100        |        | ns            |
| $E_{on}$      | turn-on energy per pulse              |                                                                                                              |                                                                 |      | 3.8        |        | mJ            |
| $E_{off}$     | turn-off energy per pulse             |                                                                                                              |                                                                 |      | 4.1        |        | mJ            |
| <b>RBSOA</b>  | reverse bias safe operating area      | $V_{GE} = \pm 15\text{ V}; R_G = 27\ \Omega;$                                                                | $T_{VJ} = 125^{\circ}\text{C}$<br>$V_{CEK} = 1200\text{ V}$     |      |            | 105    | A             |
| <b>SCSOA</b>  | short circuit safe operating area     |                                                                                                              | $T_{VJ} = 125^{\circ}\text{C}$                                  |      |            | 10     | $\mu\text{s}$ |
| $t_{SC}$      | short circuit duration                | $V_{CE} = 900\text{ V}; V_{GE} = \pm 15\text{ V};$                                                           |                                                                 |      | 140        |        | A             |
| $I_{SC}$      | short circuit current                 | $R_G = 27\ \Omega;$ non-repetitive                                                                           |                                                                 |      |            |        |               |
| $R_{thJC}$    | thermal resistance junction to case   | (per IGBT)                                                                                                   |                                                                 |      |            | 0.64   | K/W           |

**Brake Chopper D7**

| Symbol     | Definitions                         | Conditions                                                                                               | Ratings                                                         |      |              | Unit |               |
|------------|-------------------------------------|----------------------------------------------------------------------------------------------------------|-----------------------------------------------------------------|------|--------------|------|---------------|
|            |                                     |                                                                                                          | min.                                                            | typ. | max.         |      |               |
| $V_{RRM}$  | max. repetitive reverse voltage     | $T_{VJ} = 25^{\circ}\text{C}$                                                                            |                                                                 |      | 1200         | V    |               |
| $I_{F25}$  | forward current                     | $T_C = 25^{\circ}\text{C}$                                                                               |                                                                 |      | 44           | A    |               |
| $I_{F80}$  |                                     | $T_C = 80^{\circ}\text{C}$                                                                               |                                                                 |      | 29           | A    |               |
| $V_F$      | forward voltage                     | $I_F = 30\text{ A}; V_{GE} = 0\text{ V}$                                                                 | $T_{VJ} = 25^{\circ}\text{C}$<br>$T_{VJ} = 125^{\circ}\text{C}$ |      | 1.95<br>1.95 | 2.2  | V<br>V        |
| $I_R$      | reverse current                     | $V_R = V_{RRM}$                                                                                          | $T_{VJ} = 25^{\circ}\text{C}$<br>$T_{VJ} = 125^{\circ}\text{C}$ |      | 0.8          | 2.0  | mA<br>mA      |
| $Q_{rr}$   | reverse recovery charge             | $V_R = 600\text{ V}$<br>$di_F/dt = 600\text{ A}/\mu\text{s}$<br>$I_F = 30\text{ A}; V_{GE} = 0\text{ V}$ | $T_{VJ} = 125^{\circ}\text{C}$                                  |      | 3.5          |      | $\mu\text{C}$ |
| $I_{RM}$   | max. reverse recovery current       |                                                                                                          |                                                                 |      | 30           |      | A             |
| $t_{rr}$   | reverse recovery time               |                                                                                                          |                                                                 |      | 350          |      | ns            |
| $E_{rec}$  | reverse recovery energy             |                                                                                                          |                                                                 |      | 0.9          |      | mJ            |
| $R_{thJC}$ | thermal resistance junction to case | (per diode)                                                                                              |                                                                 |      |              | 1.2  | K/W           |

 $T_C = 25^{\circ}\text{C}$  unless otherwise stated

**Input Rectifier Bridge D11 - D16**

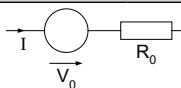
| Symbol     | Definitions                         | Conditions              | Ratings |      |      | Unit             |
|------------|-------------------------------------|-------------------------|---------|------|------|------------------|
|            |                                     |                         | min.    | typ. | max. |                  |
| $V_{RRM}$  | max. repetitive reverse voltage     |                         |         |      | 1600 | V                |
| $I_{FAV}$  | average forward current             | sine 180°               |         |      | 70   | A                |
| $I_{DAVM}$ | max. average DC output current      | rect.; $d = 1/3$        |         |      | 190  | A                |
| $I_{FSM}$  | max. forward surge current          | $t = 10$ ms; sine 50 Hz |         |      | 700  | A                |
|            |                                     |                         |         |      | 620  | A                |
| $I^2t$     | $I^2t$ value for fusing             | $t = 10$ ms; sine 50 Hz |         |      | 1920 | A <sup>2</sup> s |
|            |                                     |                         |         |      | 2450 | A <sup>2</sup> s |
| $P_{tot}$  | total power dissipation             |                         |         |      | 192  | W                |
| $V_F$      | forward voltage                     | $I_F = 80$ A            |         | 1.2  | 1.5  | V                |
|            |                                     |                         |         | 1.2  |      | V                |
| $I_R$      | reverse current                     | $V_R = V_{RRM}$         |         | 0.05 | 0.1  | mA               |
|            |                                     |                         |         | 1.5  |      | mA               |
| $R_{thJC}$ | thermal resistance junction to case | (per diode)             |         |      | 0.65 | K/W              |

**Temperature Sensor NTC**

| Symbol      | Definitions | Conditions | Ratings |      |      | Unit       |
|-------------|-------------|------------|---------|------|------|------------|
|             |             |            | min.    | typ. | max. |            |
| $R_{25}$    | resistance  |            | 4.75    | 5.0  | 5.25 | k $\Omega$ |
| $B_{25/50}$ |             |            |         | 3375 |      | K          |

**Module**

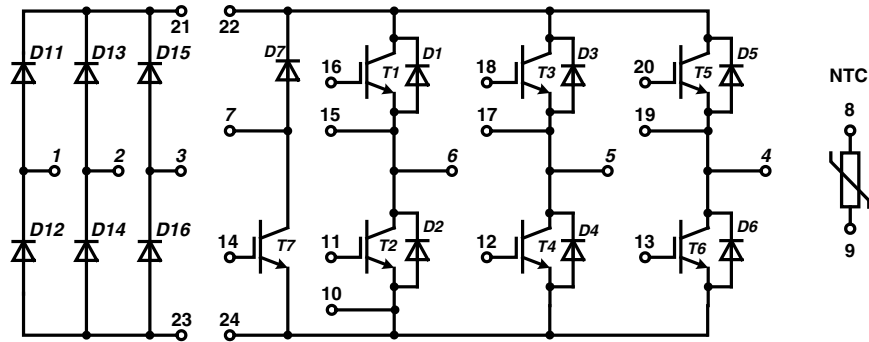
| Symbol         | Definitions                         | Conditions                     | Ratings |      |      | Unit       |
|----------------|-------------------------------------|--------------------------------|---------|------|------|------------|
|                |                                     |                                | min.    | typ. | max. |            |
| $T_{VJ}$       | operating temperature               |                                | -40     |      | 125  | °C         |
| $T_{VJM}$      | max. virtual junction temperature   |                                |         |      | 150  | °C         |
| $T_{stg}$      | storage temperature                 |                                | -40     |      | 125  | °C         |
| $V_{ISOL}$     | isolation voltage                   | $I_{ISOL} \leq 1$ mA; 50/60 Hz |         |      | 3000 | V~         |
| <b>CTI</b>     | comparative tracking index          |                                |         |      | -    |            |
| $M_d$          | mounting torque (M5)                |                                | 3       |      | 6    | Nm         |
| $d_S$          | creep distance on surface           |                                | 6       |      |      | mm         |
| $d_A$          | strike distance through air         |                                | 6       |      |      | mm         |
| $R_{pin-chip}$ | resistance pin to chip              |                                |         | 5    |      | m $\Omega$ |
| $R_{thCH}$     | thermal resistance case to heatsink | with heatsink compound         |         | 0.01 |      | K/W        |
| <b>Weight</b>  |                                     |                                |         | 300  |      | g          |

**Equivalent Circuits for Simulation**


| Symbol | Definitions         | Conditions | Ratings |      |      | Unit       |
|--------|---------------------|------------|---------|------|------|------------|
|        |                     |            | min.    | typ. | max. |            |
| $V_0$  | rectifier diode     | D8 - D13   |         |      | 0.85 | V          |
| $R_0$  |                     |            |         |      | 3.9  | m $\Omega$ |
| $V_0$  | IGBT                | T1 - T6    |         |      | 1.1  | V          |
| $R_0$  |                     |            |         |      | 25.1 | m $\Omega$ |
| $V_0$  | free wheeling diode | D1 - D6    |         |      | 1.22 | V          |
| $R_0$  |                     |            |         |      | 13   | m $\Omega$ |
| $V_0$  | IGBT                | T7         |         |      | 1.1  | V          |
| $R_0$  |                     |            |         |      | 40   | m $\Omega$ |
| $V_0$  | free wheeling diode | D7         |         |      | 1.2  | V          |
| $R_0$  |                     |            |         |      | 27.0 | m $\Omega$ |

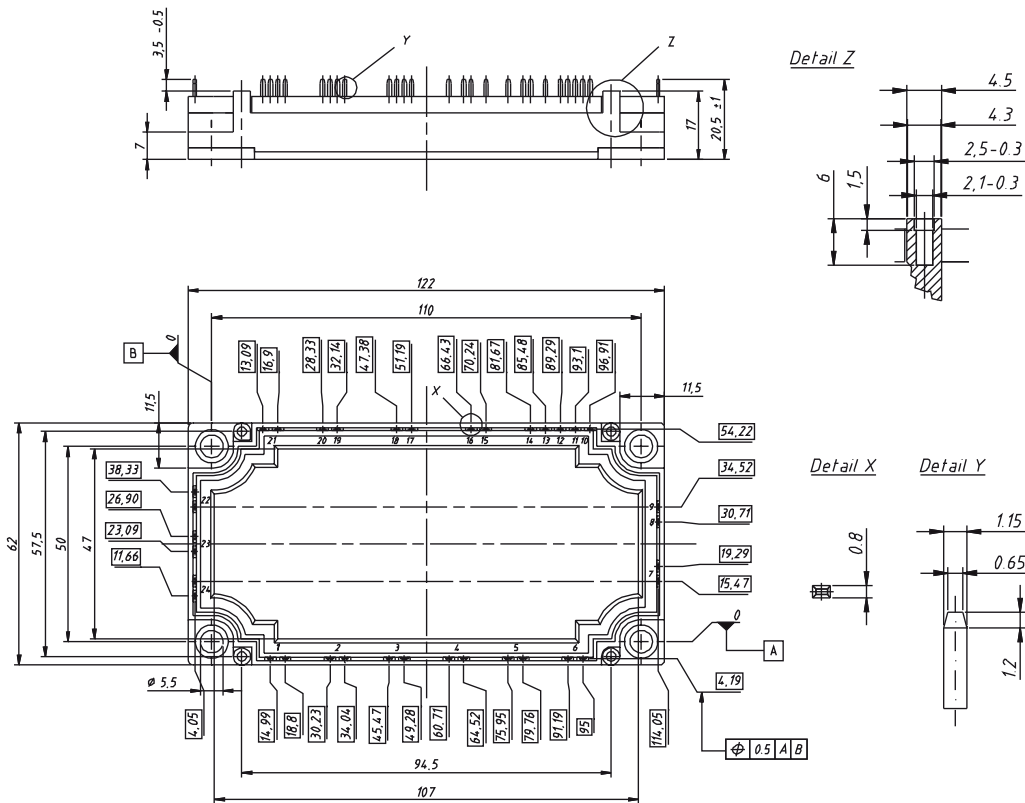
 $T_C = 25^\circ\text{C}$  unless otherwise stated

## Circuit Diagram

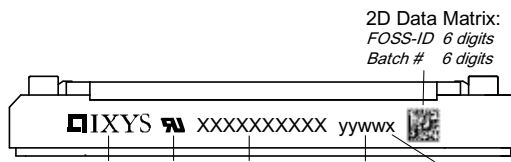


## Outline Drawing

Dimensions in mm (1 mm = 0.0394")



## Product Marking



2D Data Matrix:  
FOSS-ID 6 digits  
Batch # 6 digits

### Part number

- M = Module
- I = IGBT
- XA = XPT standard
- 60 = Current Rating [A]
- WB = 6-Pack + 3~ Rectifier Bridge & Brake Unit
- 1200 = Reverse Voltage [V]
- T = NTC
- EH = E3-Pack

| Ordering | Part Name        | Marking on Product | Delivering Mode | Base Qty | Ordering Code |
|----------|------------------|--------------------|-----------------|----------|---------------|
| Standard | MIXA60WB1200 TEH | MIXA60WB1200TEH    | Box             | 5        | 507653        |

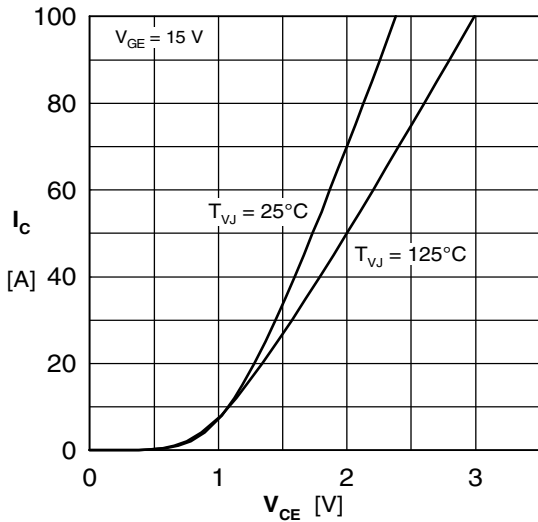
**Inverter T1 - T6**


Fig. 1 Typ. output characteristics

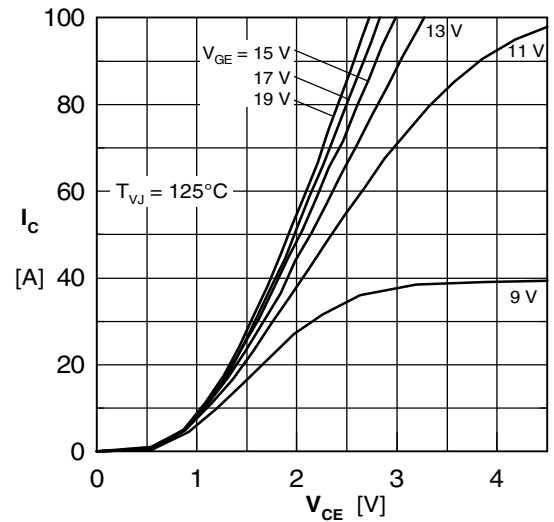


Fig. 2 Typ. output characteristics

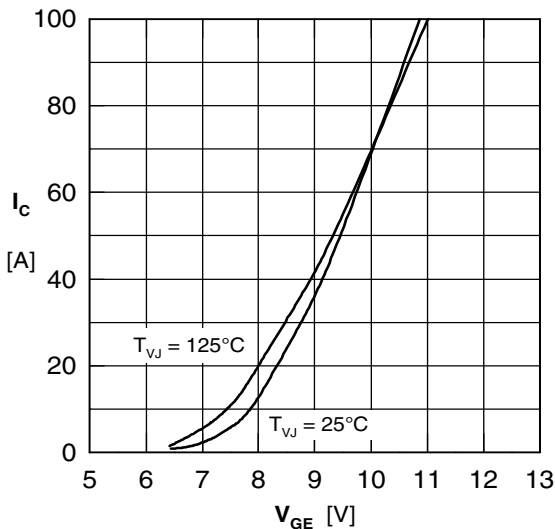


Fig. 3 Typ. transfer characteristics

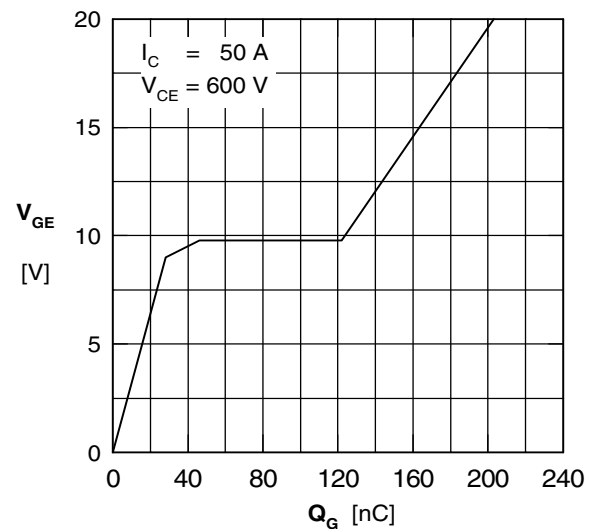


Fig. 4 Typ. turn-on gate charge

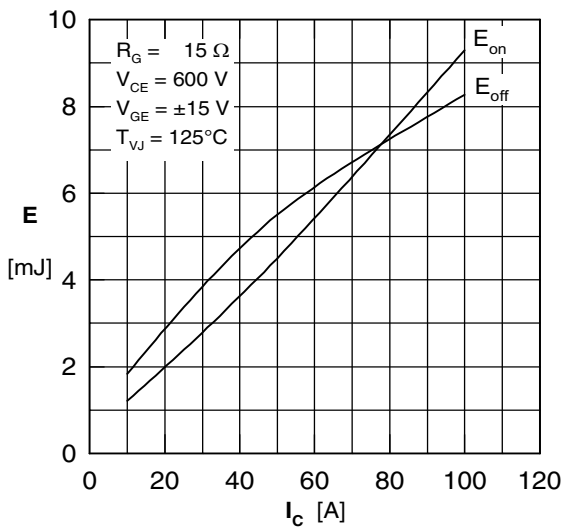


Fig. 5 Typ. switching energy vs. collector current

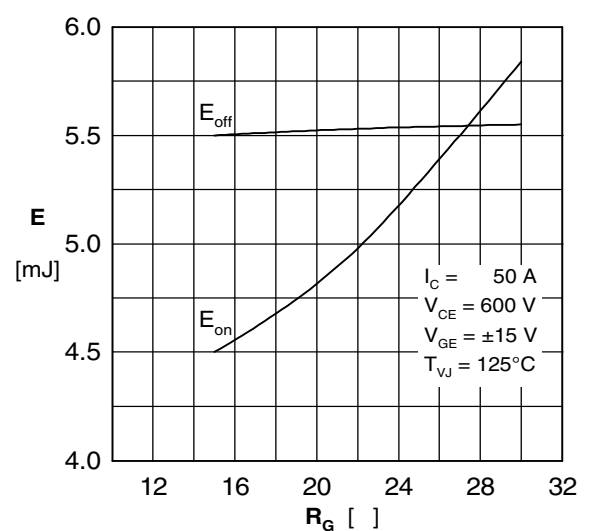


Fig. 6 Typ. switching energy vs. gate resistance

## Inverter D1 - D6

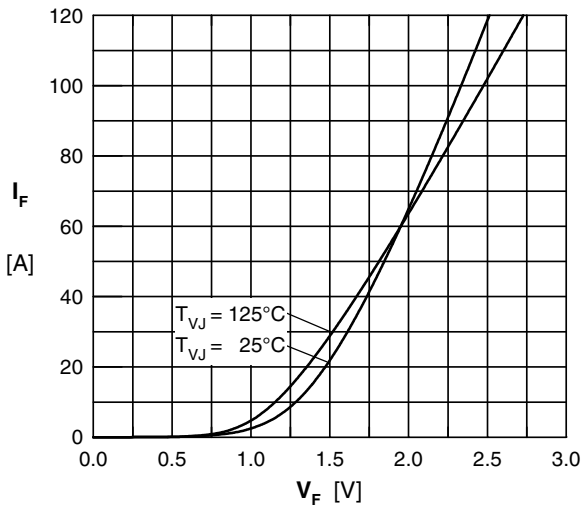


Fig. 7 Typ. Forward current versus  $V_F$

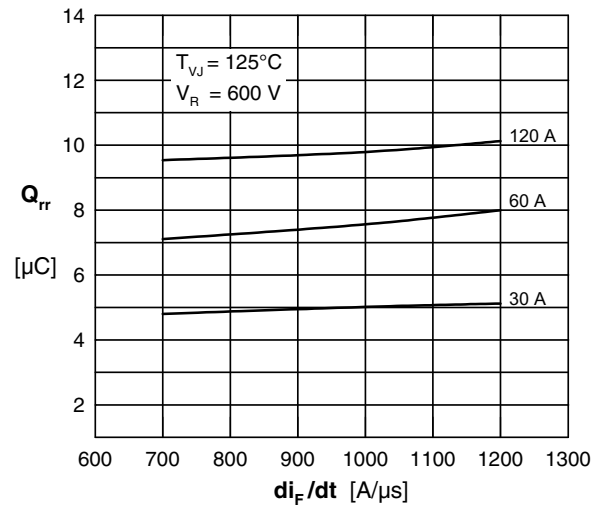


Fig. 8 Typ. reverse recov.charge  $Q_{rr}$  vs.  $di/dt$

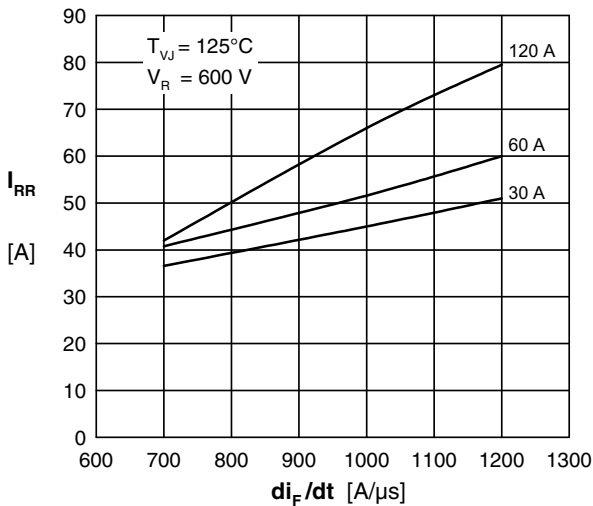


Fig. 9 Typ. peak reverse current  $I_{RM}$  vs.  $di/dt$

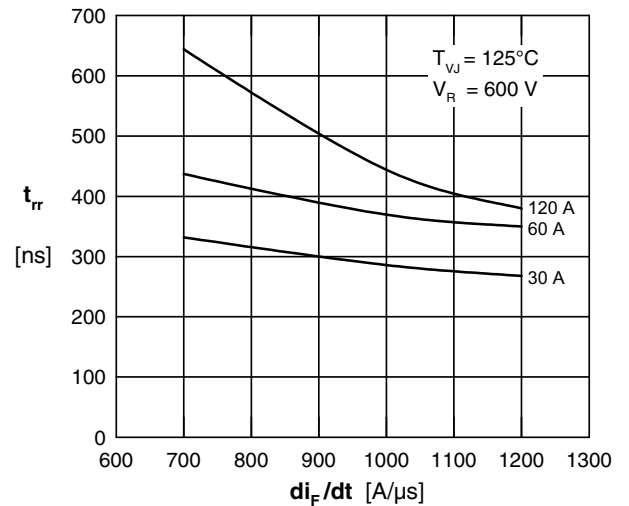


Fig. 10 Typ. recovery time  $t_{rr}$  versus  $di/dt$

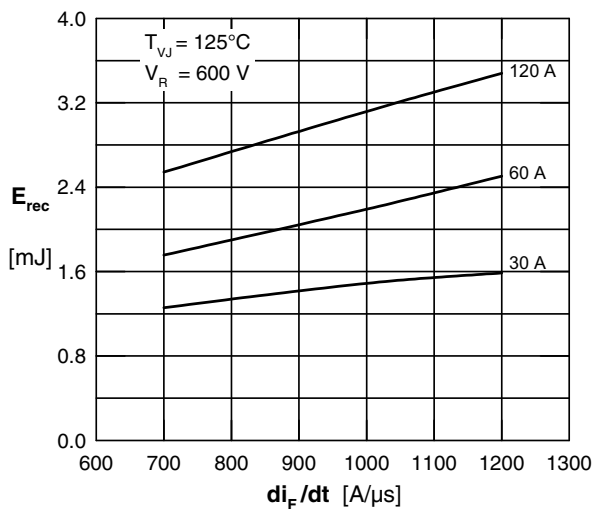


Fig. 8 Typ. recovery energy  $E_{rec}$  versus  $di/dt$

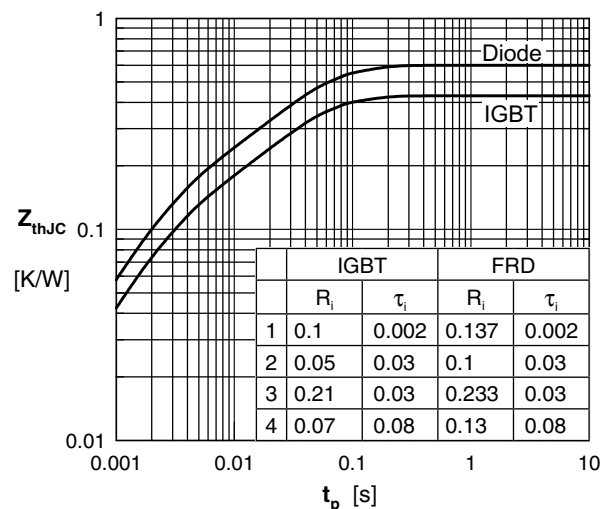


Fig. 9 Typ. transient thermal impedance

**Brake T7 & D7**

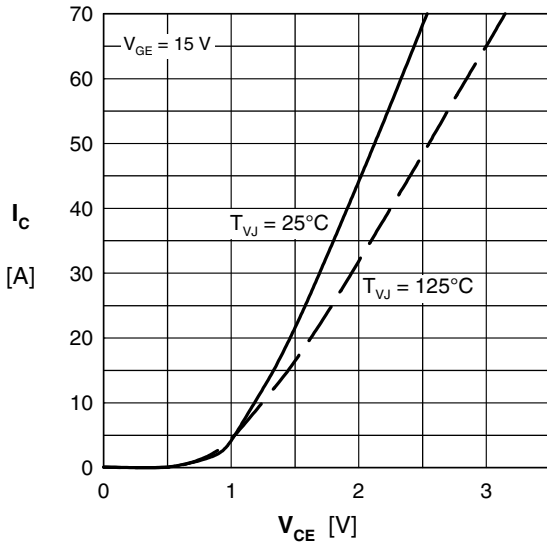


Fig. 13 Typ. output characteristics

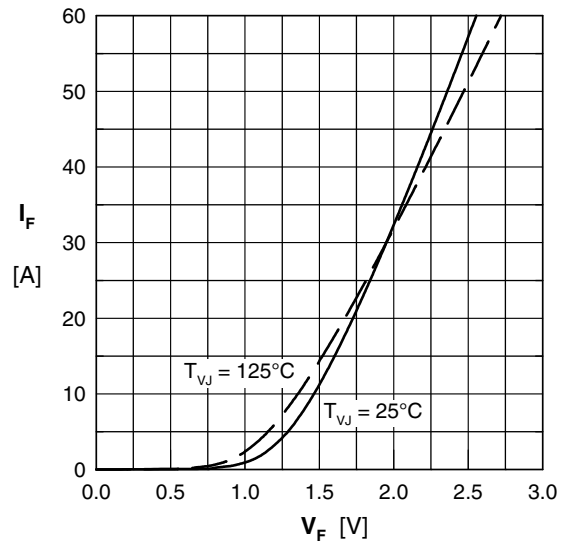


Fig. 14 Typ. forward characteristics

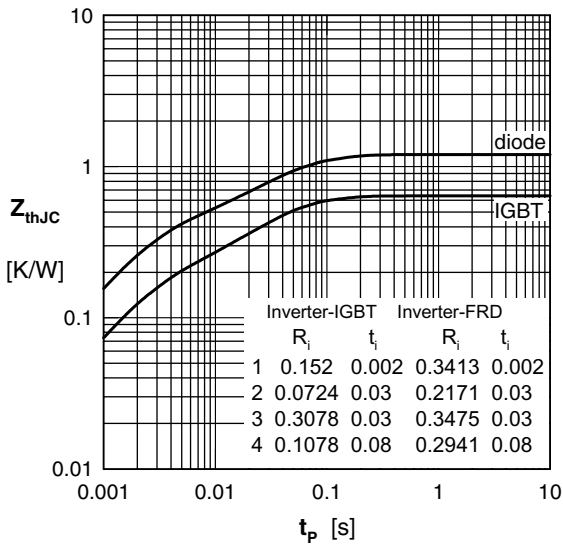


Fig. 15 Typ. transient thermal impedance

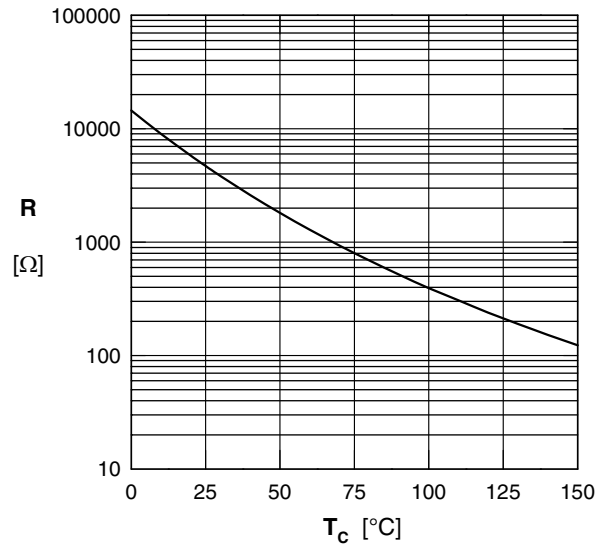


Fig. 16 Typ. NTC resistance vs. temperature



## X-ON Electronics

Largest Supplier of Electrical and Electronic Components

*Click to view similar products for [IGBT Modules category](#):*

*Click to view products by [IXYS manufacturer](#):*

Other Similar products are found below :

[F3L400R07ME4\\_B22](#) [F4-50R07W2H3\\_B51](#) [FB15R06W1E3](#) [FB20R06W1E3\\_B11](#) [FD1000R33HE3-K](#) [FD400R33KF2C-K](#)  
[FD401R17KF6C\\_B2](#) [FD-DF80R12W1H3\\_B52](#) [FF200R06YE3](#) [FF300R12KE4\\_E](#) [FF450R12ME4P](#) [FF600R12IP4V](#) [FP10R06W1E3\\_B11](#)  
[FP20R06W1E3](#) [FP50R12KT3](#) [FP75R07N2E4\\_B11](#) [FS10R12YE3](#) [FS150R07PE4](#) [FS150R12PT4](#) [FS200R12KT4R](#) [FS50R07N2E4\\_B11](#)  
[FZ1000R33HE3](#) [FZ1800R17KF4](#) [DD250S65K3](#) [DF1000R17IE4](#) [DF1000R17IE4D\\_B2](#) [DF1400R12IP4D](#) [DF200R12PT4\\_B6](#)  
[DF400R07PE4R\\_B6](#) [BSM75GB120DN2\\_E3223c-Sc](#) [F3L300R12ME4\\_B22](#) [F3L75R07W2E3\\_B11](#) [F4-50R12KS4\\_B11](#)  
[F475R07W1H3B11ABOMA1](#) [FD1400R12IP4D](#) [FD200R12PT4\\_B6](#) [FD800R33KF2C-K](#) [FF1200R17KP4\\_B2](#) [FF300R17KE3\\_S4](#)  
[FF300R17ME4\\_B11](#) [FF401R17KF6C\\_B2](#) [FF650R17IE4D\\_B2](#) [FF900R12IP4D](#) [FF900R12IP4DV](#) [STGIF7CH60TS-L](#) [FP50R07N2E4\\_B11](#)  
[FS100R07PE4](#) [FS150R07N3E4\\_B11](#) [FS150R17N3E4](#) [FS150R17PE4](#)