

# CoolMOS™<sup>1)</sup> Power MOSFET

## ISOPLUS™ - electrically isolated surface to heatsink

### Surface Mount Power Device

$$V_{DSS} = 600 \text{ V}$$

$$I_{D25} = 50 \text{ A}$$

$$R_{DS(on) \text{ max}} = 45 \text{ m}\Omega$$

Preliminary data

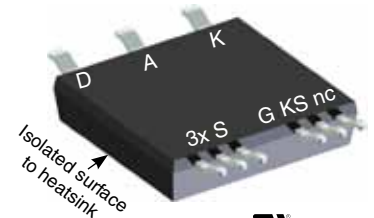
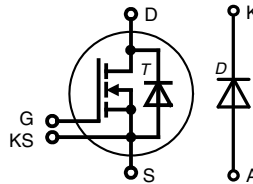

E72873

MOSFET T		Maximum Ratings	
Symbol	Conditions		
$V_{DSS}$	$T_{VJ} = 25^\circ\text{C}$ to $150^\circ\text{C}$	600	V
$V_{GS}$		$\pm 20$	V
$I_{D25}$	$T_C = 25^\circ\text{C}$	50	A
$I_{D80}$	$T_C = 80^\circ\text{C}$	38	A
$E_{AS}$ $E_{AR}$	single pulse repetitive } $I_D = 11 \text{ A}; T_C = 25^\circ\text{C}$	1950 3	mJ mJ
$dV/dt$	MOSFET $dV/dt$ ruggedness $V_{DS} = 0 \dots 480 \text{ V}$	50	V/ns

Symbol	Conditions	Characteristic Values				
		min.	typ.	max.		
( $T_{VJ} = 25^\circ\text{C}$ , unless otherwise specified)						
$R_{DS(on)}$	$I_D = 44 \text{ A}; V_{GS} = 10 \text{ V}$		40	45	m $\Omega$	
$V_{GS(th)}$	$I_D = 3 \text{ mA}; V_{DS} = V_{GS}$	2.5	3	3.5	V	
$I_{DSS}$	$V_{DS} = V_{DSS}; V_{GS} = 0 \text{ V};$ $T_{VJ} = 25^\circ\text{C}$ $T_{VJ} = 125^\circ\text{C}$		50	10	$\mu\text{A}$ $\mu\text{A}$	
$I_{GSS}$	$V_{DS} = 0 \text{ V}; V_{GS} = \pm 20 \text{ V}$			100	nA	
$t_{d(on)}$ $t_r$ $t_{d(off)}$ $t_f$ $E_{on}$ $E_{off}$ $E_{rec}$	Inductive switching boost mode with diode D $V_{DS} = 380 \text{ V}; I_D = 30 \text{ A}$ $V_{GS} = 10 \text{ V}; R_G = 33 \Omega$		80		ns	
			40		ns	
			750		ns	
			40		ns	
			1.3		mJ	
			0.45		mJ	
			0.35		mJ	
$C_{iss}$ $C_{oss}$	$V_{GS} = 0 \text{ V}; V_{DS} = 100 \text{ V}; f = 1 \text{ MHz}$		6800		pF	
				320		pF
$Q_g$ $Q_{gs}$ $Q_{gd}$	$V_{DS} = 400 \text{ V}; I_D = 44 \text{ A}$ $V_{GS} = 10 \text{ V}; R_G = 3.3 \Omega$		150	190	nC	
				35		nC
				50		nC
$R_{thJC}$ $R_{thJH}$	with heatsink compound (IXYS test setup)			0.4	K/W	
			tbd	tbd		K/W

### Features

- **Fast CoolMOS™<sup>1)</sup>** power MOSFET 4<sup>th</sup> generation
  - high blocking capability
  - lowest resistance
  - avalanche rated for unclamped inductive switching (UIS)
  - low thermal resistance due to reduced chip thickness
- **Package**
  - isolated surface to heatsink
  - low coupling capacity between pins and heatsink
  - PCB space saving
  - enlarged creepage towards heatsink
  - application friendly pinout
  - low inductive current path
  - high reliability

### Applications

- Buck / boost chopper
- Optimized for boost configuration
- PFC stage

<sup>1)</sup> CoolMOS™ is a trademark of Infineon Technologies AG.

Source-Drain Diode of MOSFET T					
Symbol	Conditions	Maximum Ratings			
$I_{S25}$	$T_C = 25^\circ\text{C}$	50	A		
$I_{S80}$	$T_C = 80^\circ\text{C}$	38	A		
Symbol	Conditions	Characteristic Values			
( $T_{VJ} = 25^\circ\text{C}$ , unless otherwise specified)					
$V_{SD}$	$I_F = 44\text{ A}; V_{GS} = 0\text{ V}$		0.9	1.0	V
$t_{rr}$	$I_F = 44\text{ A}; -di_F/dt = 100\text{ A}/\mu\text{s}; V_R = 400\text{ V}$		600		ns
$Q_{RM}$			17		$\mu\text{C}$
$I_{RM}$			60		A

Diode D					
Symbol	Conditions	Maximum Ratings			
$I_{F25}$	$T_C = 25^\circ\text{C}; \text{DC}$	96	A		
$I_{F80}$	$T_C = 80^\circ\text{C}; \text{DC}$	61	A		
Symbol	Conditions	Characteristic Values			
( $T_{VJ} = 25^\circ\text{C}$ , unless otherwise specified)					
$V_{RRM}$		$T_{VJ} = 25^\circ\text{C}$		600	V
$V_F$	$I_F = 25\text{ A}$	$T_{VJ} = 25^\circ\text{C}$	1.2	1.4	V
		$T_{VJ} = 125^\circ\text{C}$	1.3		
$I_R$	$V_R = V_{RRM}$	$T_{VJ} = 25^\circ\text{C}$		150	$\mu\text{A}$
		$T_{VJ} = 125^\circ\text{C}$	tbd		mA
$I_{RM}$	$I_F = 30\text{ A}; V_R = 350\text{ V}$ $-di/dt = 240\text{ A}/\mu\text{s}$	$T_{VJ} = 100^\circ\text{C}$	10		A
$t_{rr}$	$I_F = 1\text{ A}; V_R = 30\text{ V}$ $-di/dt = 100\text{ A}/\mu\text{s}$	$T_{VJ} = 100^\circ\text{C}$	35	50	ns
$R_{thJC}$	per diode			0.7	K/W
$R_{thJH}$	with heatsink compound (IXYS test setup)		tbd		k/W

Component					
Symbol	Conditions	Maximum Ratings			
$T_{VJ}$		-55...+150 °C			
$T_{stg}$		-55...+125 °C			
$V_{ISOL}$	$I_{ISOL} \leq 1\text{ mA}; 50/60\text{ Hz}$	2500	V~		
$F_C$	mounting force	40 ... 130	N		
Symbol	Conditions	Characteristic Values			
$C_P$	coupling capacity between shorted pins and backside metal		90		pF
$d_S, d_A$	pin - pin	1.65			mm
$d_S, d_A$	pin - backside metal	4			mm
CTI		400			
Weight			8		g

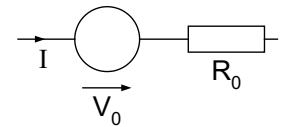
**Equivalent Circuits for Simulation**
**Conduction**

Boost Diode (typ. at  $T_J = 125^\circ\text{C}$ )  
 $V_0 = \text{tbd V}; R_0 = \text{tbd m}\Omega$

Ordering	Part Number	Marking on Product	Delivering Mode	Base Qty	Ordering Code
Standard	MKE38RK600DFELB-TRR	MKE38RK600DFELB	Tape & Reel	200	510479
	MKE38RK600DFELB	MKE38RK600DFELB	Blister	45	510231

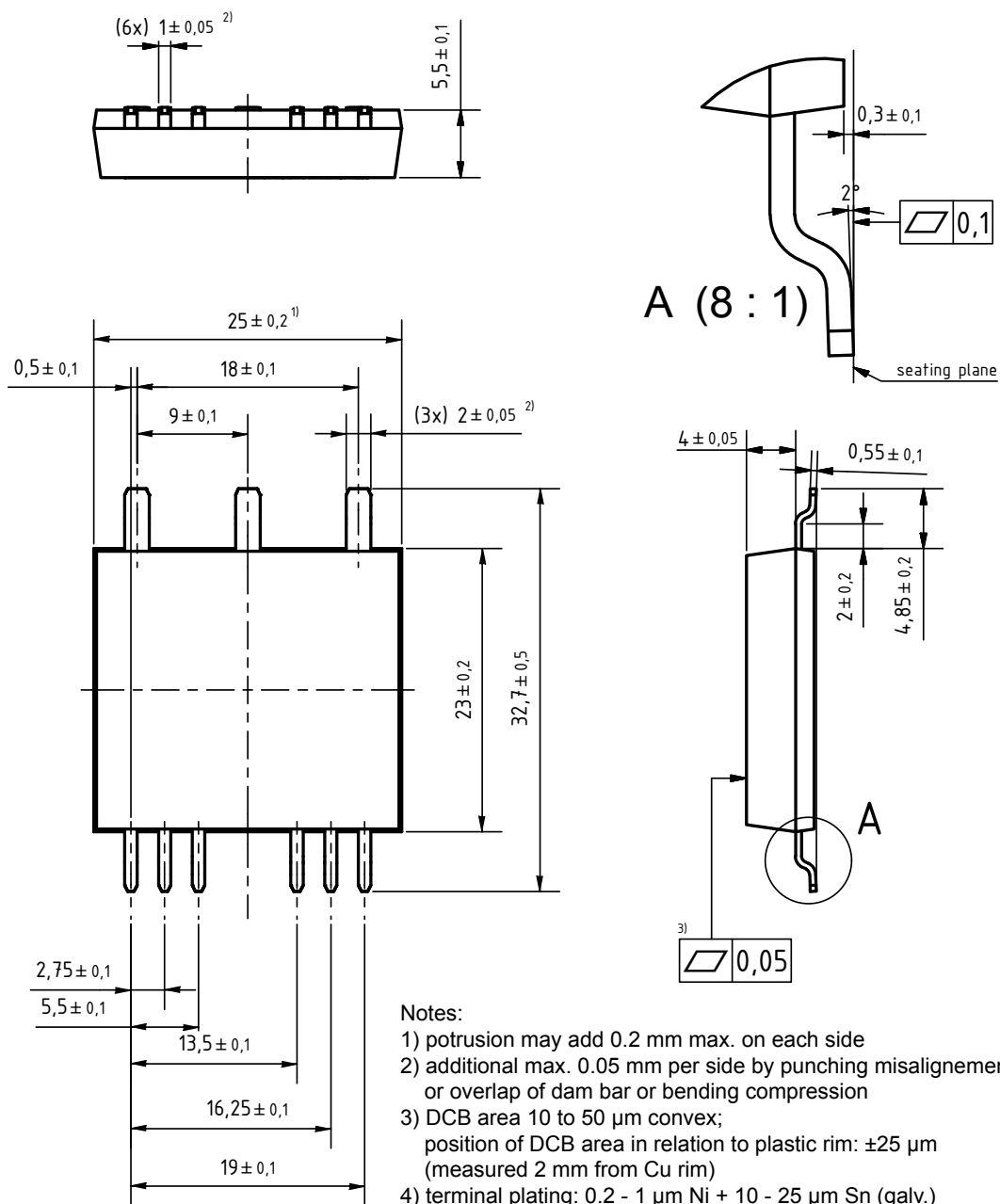
**Notes:**

- 1) protrusion may add 0.2 mm max. on each side
- 2) additional max. 0.05 mm per side by punching misalignment or overlap of dam bar or bending compression
- 3) DCB area 10 to 50  $\mu$ m convex; position of DCB area in relation to plastic rim:  $\pm 25$   $\mu$ m (measured 2 mm from Cu rim)
- 4) terminal plating: 0.2 - 1  $\mu$ m Ni + 10 - 25  $\mu$ m Sn (galv.) cutting edges may be partially free of plating

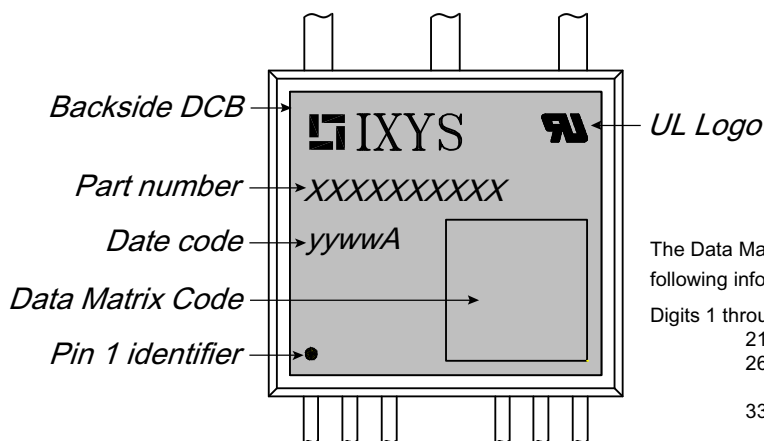

The Data Matrix Code contains the following information in 36 digits:

- Digits 1 through 20: part number
- 21 to 25: date code (YYWWA)
- 26 to 31: assembly lot code
- 32: reserved for special information
- 33 to 36: may be used for subsequent module numbering within the assembly lot

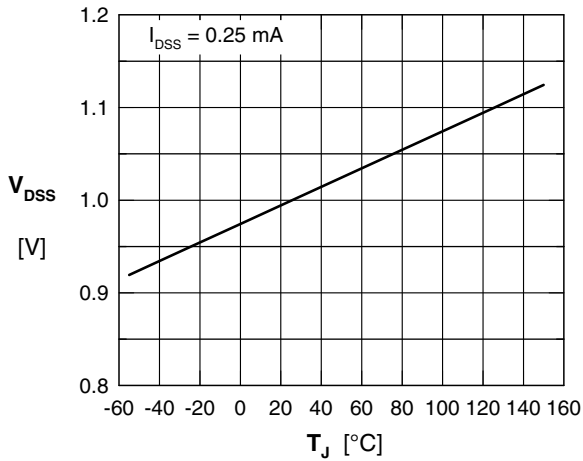

Fig. 1 Drain source breakdown voltage versus temperature  $T_{VJ}$

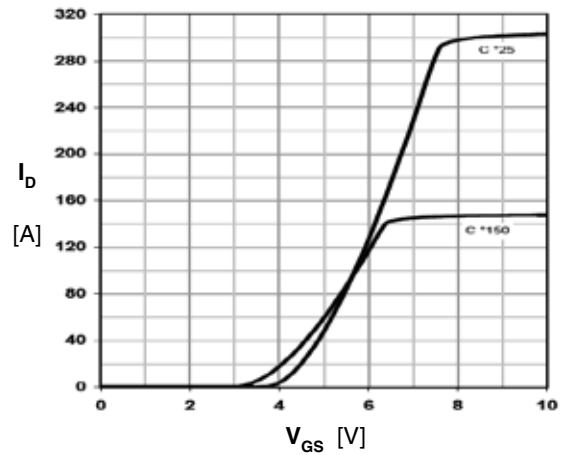

Fig. 2 Typ. transfer characteristics

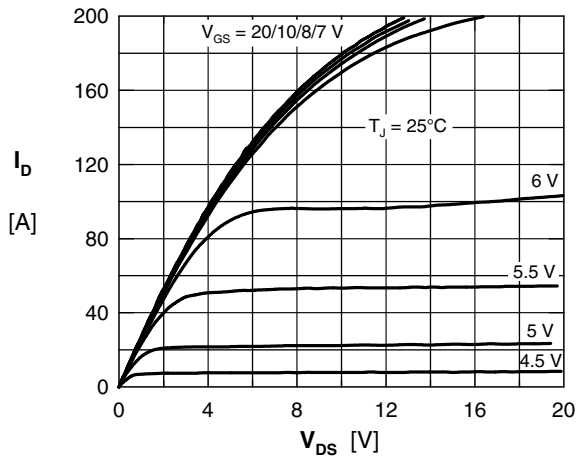

Fig. 3 Typical output characteristics

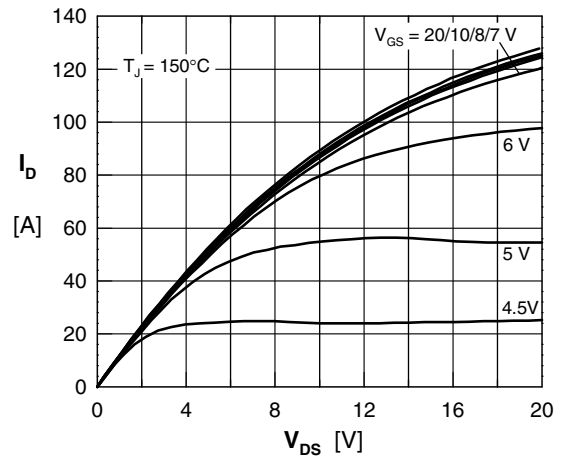

Fig. 4 Typical output characteristics

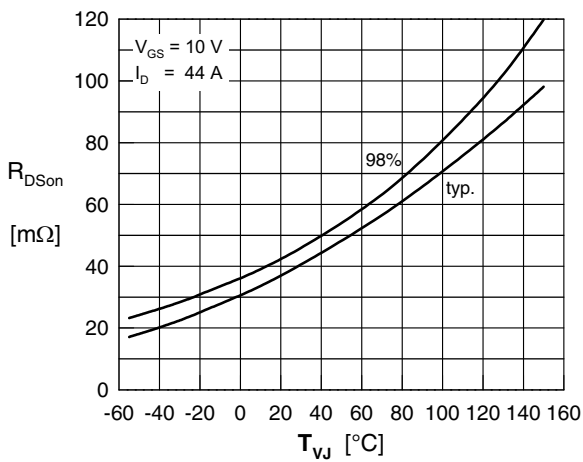

Fig. 5 Drain source on-state resistance  $R_{DS(on)}$  vs. junction temperature  $T_{VJ}$

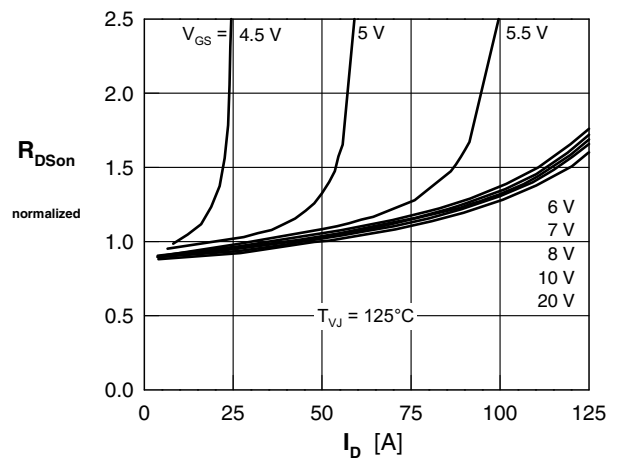

Fig. 6 Drain source on-state resistance,  $R_{DS(on)}$  versus  $I_D$

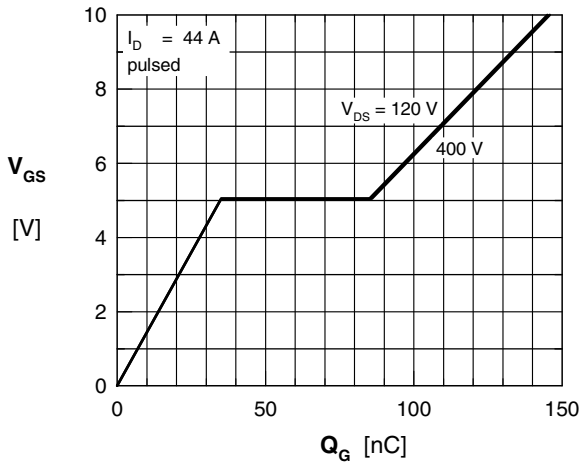

Fig. 7 Typ. turn-on gate charge

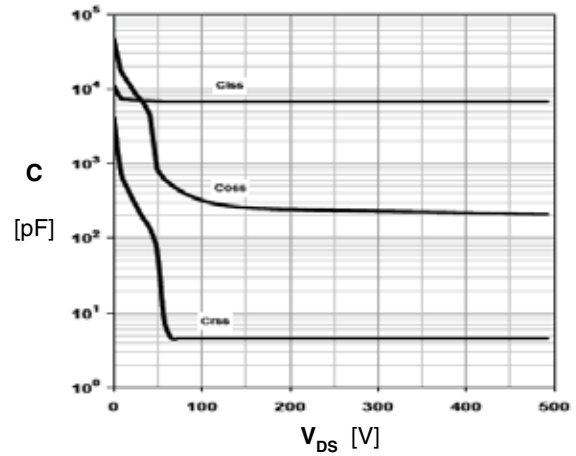

Fig. 8 Typ. capacities, MOSFET only

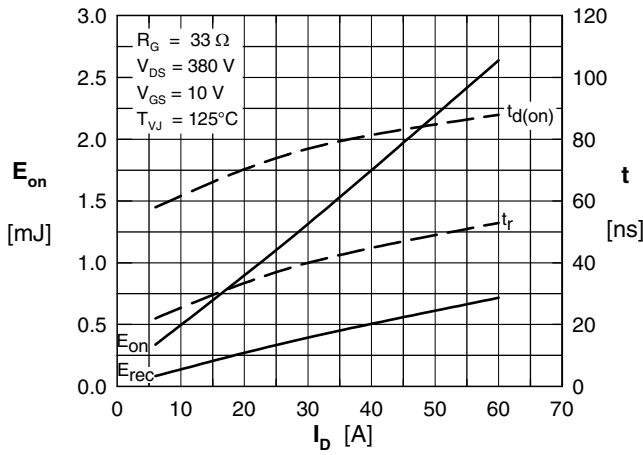

Fig. 9 Typ. turn-on energy and switching times vs. collector current, inductive switching

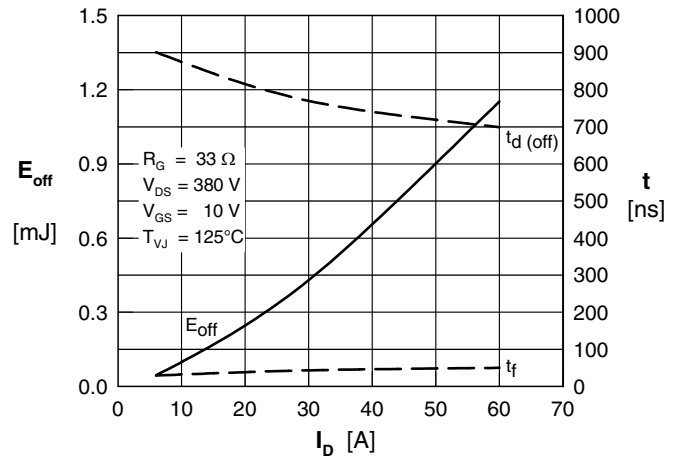

Fig. 10 Typ. turn-off energy and switching times vs. collector-current, inductive switching

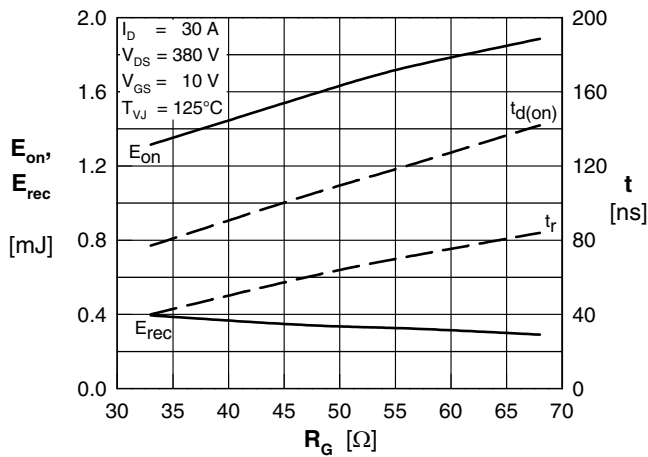

Fig. 11 Typ. turn-on energy and switching times vs. gate resistor, inductive switching

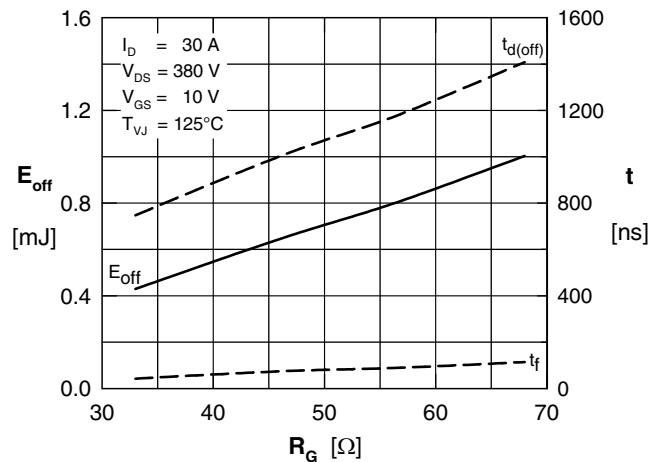

Fig. 12 Typ. turn-off energy and switching times vs. gate resistor, inductive switching

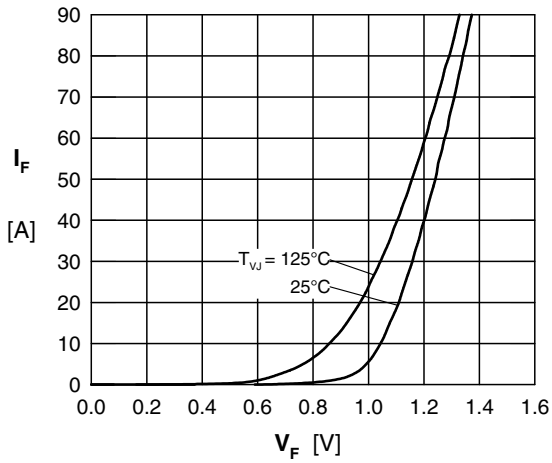

Fig. 13 Typ. forward characteristics of diode D

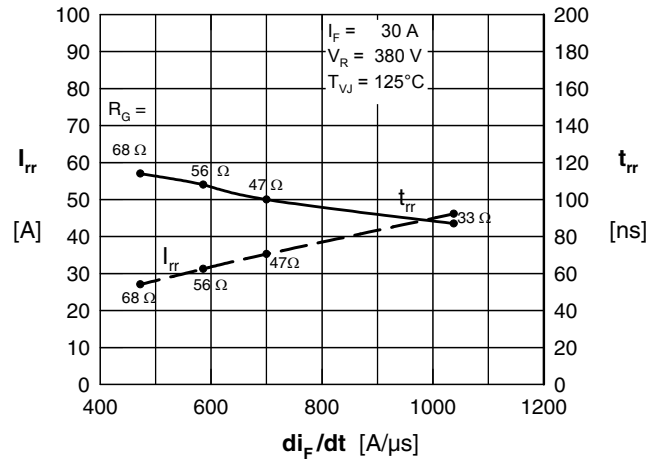

Fig. 14 Typ. reverse recovery characteristics of diode D

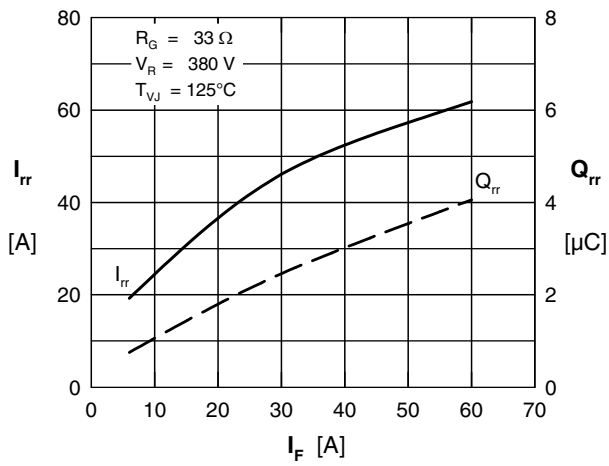

Fig. 15 Typ. reverse recovery characteristics of diode D

## X-ON Electronics

Largest Supplier of Electrical and Electronic Components

*Click to view similar products for [MOSFET](#) category:*

*Click to view products by [IXYS](#) manufacturer:*

Other Similar products are found below :

[614233C](#) [648584F](#) [IRFD120](#) [JANTX2N5237](#) [FCA20N60\\_F109](#) [FDZ595PZ](#) [2SK2545\(Q,T\)](#) [405094E](#) [423220D](#) [TPCC8103,L1Q\(CM](#)  
[MIC4420CM-TR](#) [VN1206L](#) [614234A](#) [715780A](#) [NTNS3166NZT5G](#) [SSM6J414TU,LF\(T](#) [751625C](#) [BUK954R8-60E](#) [NTE6400](#) [SQJ402EP-](#)  
[T1-GE3](#) [2SK2614\(TE16L1,Q\)](#) [2N7002KW-FAI](#) [DMN1017UCP3-7](#) [EFC2J004NUZTDG](#) [ECH8691-TL-W](#) [FCAB21350L1](#) [P85W28HP2F-](#)  
[7071](#) [DMN1053UCP4-7](#) [NTE221](#) [NTE222](#) [NTE2384](#) [NTE2903](#) [NTE2941](#) [NTE2945](#) [NTE2946](#) [NTE2960](#) [NTE2967](#) [NTE2969](#) [NTE2976](#)  
[NTE6400A](#) [NTE2910](#) [NTE2916](#) [NTE2956](#) [NTE2911](#) [DMN2080UCB4-7](#) [TK10A80W,S4X\(S](#) [SSM6P69NU,LF](#) [DMP22D4UFO-7B](#)  
[DMN1006UCA6-7](#) [DMN16M9UCA6-7](#)