



Parameters	Ratings	Units
Blocking Voltage	400	V_P
Load Current	150	mA_{rms} / mA_{DC}
On-Resistance (max)	22	Ω

Features

- 3750V_{rms} Input to Output Isolation
- Low Drive Power Requirements (TTL/CMOS Compatible)
- No Moving Parts
- High Reliability
- Arc-Free With No Snubbing Circuits
- No EMI/RFI Generation
- FCC Compatible
- VDE Compatible
- Small 6-Pin Package
- Machine Insertable, Wave Solderable

Applications

- Telecommunications
 - Telecom Switching
 - Tip/Ring Circuits
 - Modem Switching (Laptop, Notebook, PocketSize)
 - Hook Switch
 - Dial Pulsing
 - Ground Start
 - Ringing Injection
- Instrumentation
 - Multiplexers
 - Data Acquisition
 - Electronic Switching
 - I/O Subsystems
- Meters (Watt-Hour, Water, Gas)
- Medical Equipment Patient/Equipment Isolation
- Security
- Aerospace
- Industrial Controls

Description

PLA110 is a normally open (1-Form-A) solid state relay that uses optically coupled MOSFET technology to provide 3750V_{rms} of input to output isolation. Its optically coupled outputs, which use the patented OptoMOS architecture, are controlled by a highly efficient GaAIAs infrared LED.

The PLA110 can be used to replace mechanical relays, and offers the superior reliability associated with semiconductor devices. Because it has no moving parts, it offers faster, bounce-free switching in a more compact surface mount or thru-hole package.

Approvals

- UL Recognized Component: File E76270
- CSA Certified Component: Certificate 1175739
- EN/IEC 60950-1 Certified Component: TUV Certificate B 09 07 49410 004

Ordering Information

Part #	Description
PLA110	6-Lead DIP (50/Tube)
PLA110S	6-Lead Surface Mount (50/Tube)
PLA110STR	6-Lead Surface Mount (1000/Reel)

Pin Configuration

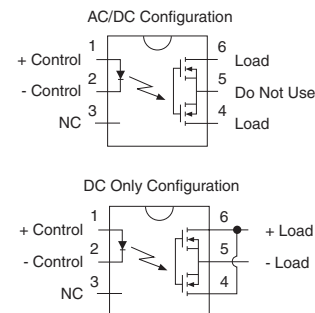

Switching Characteristics of Normally Open Devices

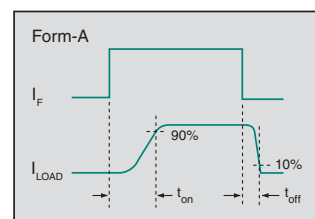

Absolute Maximum Ratings @ 25°C

Parameter	Min	Max	Units
Blocking Voltage	-	400	V _P
Reverse Input Voltage	-	5	V
Input Control Current	-	50	mA
Peak (10ms)	-	1	A
Input Power Dissipation ¹	-	150	mW
Total Package Dissipation ²	-	800	mW
Isolation Voltage, Input to Output	3750	-	V _{rms}
Operational Temperature	-40	+85	°C
Storage Temperature	-40	+125	°C

Absolute Maximum Ratings are stress ratings. Stresses in excess of these ratings can cause permanent damage to the device. Functional operation of the device at conditions beyond those indicated in the operational sections of this data sheet is not implied.

¹ Derate linearly 1.33 mW / °C

² Derate linearly 6.67 mW / °C

Electrical Characteristics @ 25°C

Parameters	Conditions	Symbol	Min	Typ	Max	Units
Output Characteristics						
Load Current						
Continuous, AC/DC Configuration	-	I _L	-	-	150	mA _{rms} / mA _{DC}
Continuous, DC Configuration	-		-	-	250	mA _{DC}
Peak	t=10ms	I _{LPK}	-	-	±400	mA _P
On-Resistance						
AC/DC Configuration	I _L =150mA	R _{ON}	-	-	22	Ω
DC Configuration	I _L =250mA		-	-	7	
Off-State Leakage Current	V _L =400V _P	I _{LEAK}	-	-	1	μA
Switching Speeds						
Turn-On	I _F =5mA, V _L =10V	t _{on}	-	-	1	ms
Turn-Off		t _{off}	-	-	0.5	
Output Capacitance	V _L =50V, f=1MHz	C _{OUT}	-	25	-	pF
Input Characteristics						
Input Control Current to Activate	I _L =150mA	I _F	-	-	5	mA
Input Control Current to Deactivate	-	I _F	0.4	0.7	-	mA
Input Voltage Drop	I _F =5mA	V _F	0.9	1.2	1.4	V
Reverse Input Current	V _R =5V	I _R	-	-	10	μA
Common Characteristics						
Input to Output Capacitance	-	C _{I/O}	-	3	-	pF

PERFORMANCE DATA @ 25°C (Unless Otherwise Noted) *

Typical LED Forward Voltage Drop
(N=50, $I_F=5mA$)

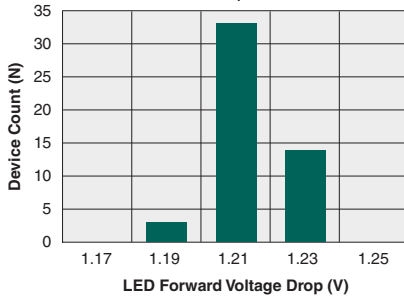

Typical Turn-On Time
(N=50, $I_F=5mA$, $I_L=100mA_{DC}$)

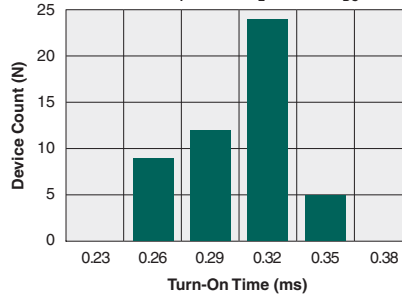

Typical Turn-Off Time
(N=50, $I_F=5mA$, $I_L=100mA_{DC}$)

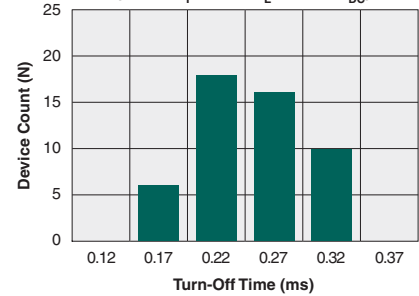

Typical I_F for Switch Operation
(N=50, $I_L=150mA_{DC}$)

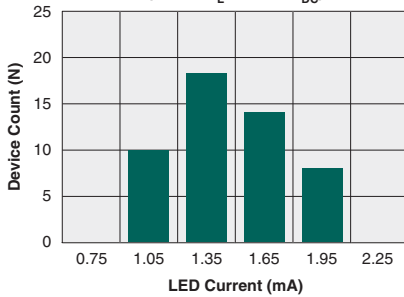

Typical I_F for Switch Dropout
(N=50)

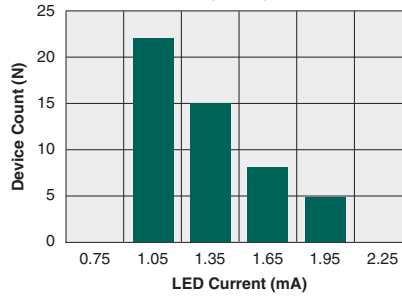

Typical On-Resistance Distribution
(N=50, $I_F=5mA$, $I_L=150mA_{DC}$)

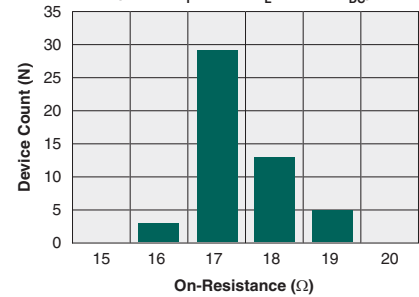

Typical Blocking Voltage Distribution
(N=50)

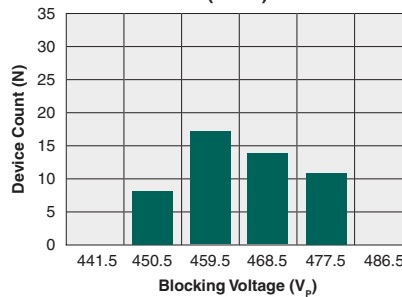

Typical LED Forward Voltage Drop vs. Temperature

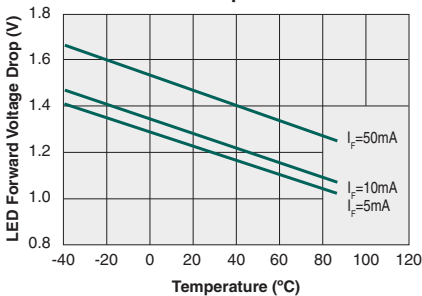

Typical Turn-On Time vs. LED Forward Current
($I_L=150mA_{DC}$)

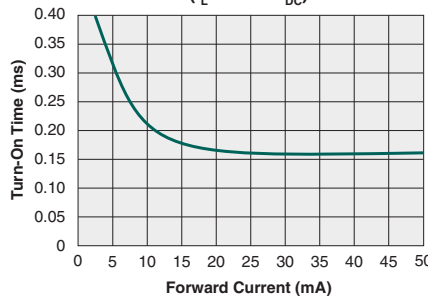

Typical Turn-Off Time vs. LED Forward Current
($I_L=150mA_{DC}$)

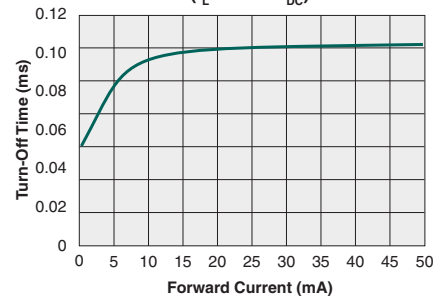

*The Performance data shown in the graphs above is typical of device performance. For guaranteed parameters not indicated in the written specifications, please contact our application department.

PERFORMANCE DATA @ 25°C (Unless Otherwise Noted) *

**Typical On-Resistance vs. Temperature
AC/DC Configuration
($I_L=150mA_{DC}$)**

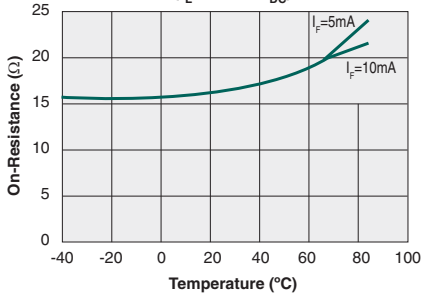

**Typical Turn-On Time vs. Temperature
($I_L=100mA_{DC}$)**

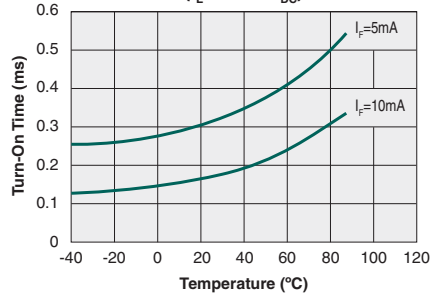

**Typical Turn-Off Time vs. Temperature
($I_F=5mA, I_L=100mA_{DC}$)**

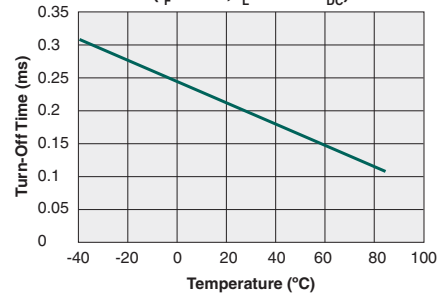

**Typical On-Resistance vs. Temperature - DC Configuration
($I_L=150mA_{DC}$)**

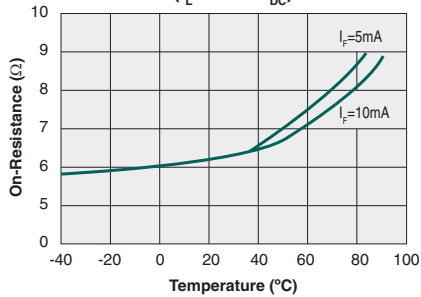

**Typical I_F for Switch Operation vs. Temperature
($I_L=100mA_{DC}$)**

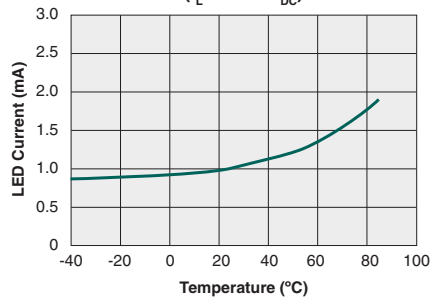

**Typical I_F for Switch Dropout vs. Temperature
($I_L=100mA_{DC}$)**

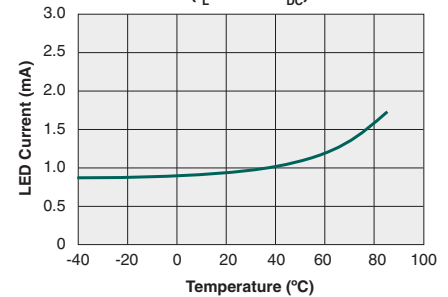

**Typical On Resistance vs. Temperature
($I_F=5mA; I_L=100mA$ Instantaneous)**

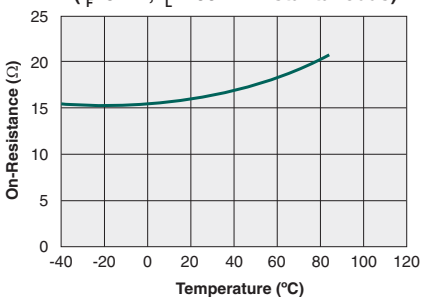

**Typical Load Current vs. Load Voltage
($I_F=5mA$)**

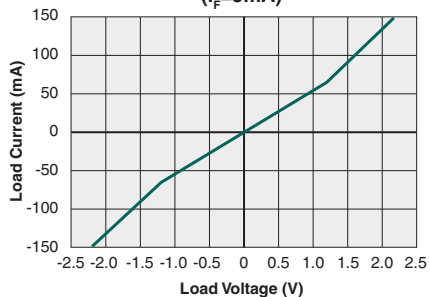

**Maximum Load Current vs. Temperature
(N=50)**

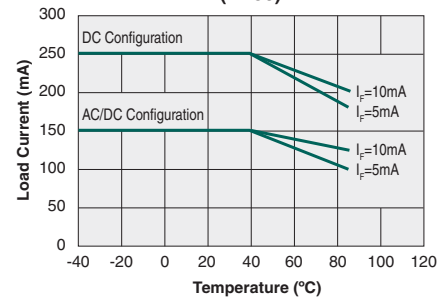

Typical Blocking Voltage vs. Temperature

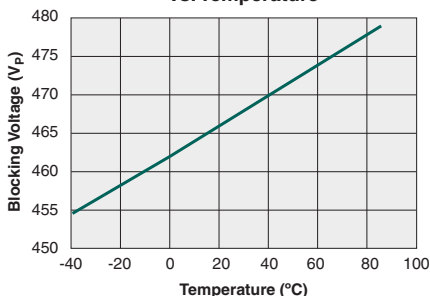

**Typical Leakage vs. Temperature
Measured across Pins 4&6**

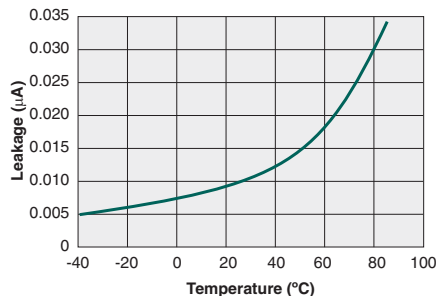

Energy Rating Curve

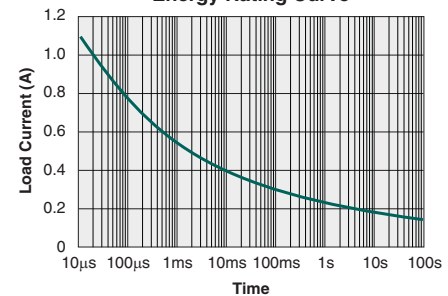

*The Performance data shown in the graphs above is typical of device performance. For guaranteed parameters not indicated in the written specifications, please contact our application department.

Manufacturing Information

Moisture Sensitivity



All plastic encapsulated semiconductor packages are susceptible to moisture ingress. IXYS Integrated Circuits Division classified all of its plastic encapsulated devices for moisture sensitivity according to the latest version of the joint industry standard, **IPC/JEDEC J-STD-020**, in force at the time of product evaluation. We test all of our products to the maximum conditions set forth in the standard, and guarantee proper operation of our devices when handled according to the limitations and information in that standard as well as to any limitations set forth in the information or standards referenced below.

Failure to adhere to the warnings or limitations as established by the listed specifications could result in reduced product performance, reduction of operable life, and/or reduction of overall reliability.

This product carries a **Moisture Sensitivity Level (MSL) rating** as shown below, and should be handled according to the requirements of the latest version of the joint industry standard **IPC/JEDEC J-STD-033**.

Device	Moisture Sensitivity Level (MSL) Rating
PLA110 / PLA110S	MSL 1

ESD Sensitivity



This product is **ESD Sensitive**, and should be handled according to the industry standard **JESD-625**.

Reflow Profile

This product has a maximum body temperature and time rating as shown below. All other guidelines of **J-STD-020** must be observed.

Device	Maximum Temperature x Time
PLA110 / PLA110S	250°C for 30 seconds

Board Wash

IXYS Integrated Circuits Division recommends the use of no-clean flux formulations. However, board washing to remove flux residue is acceptable. Since IXYS Integrated Circuits Division employs the use of silicone coating as an optical waveguide in many of its optically isolated products, the use of a short drying bake could be necessary if a wash is used after solder reflow processes. Chlorine- or Fluorine-based solvents or fluxes should not be used. Cleaning methods that employ ultrasonic energy should not be used.



Mechanical Dimensions

PLA110

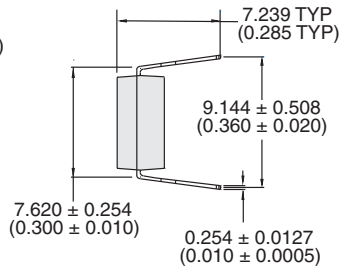
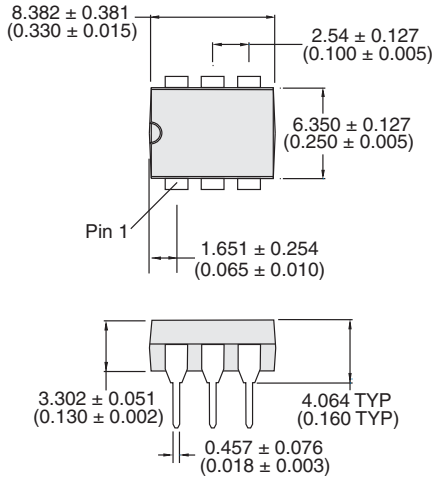

PCB Hole Pattern

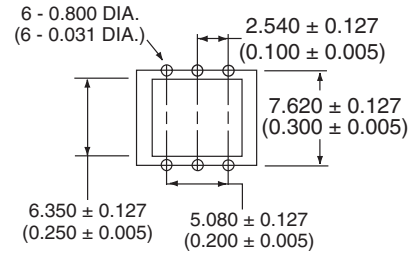

Dimensions
mm
(inches)

PLA110S

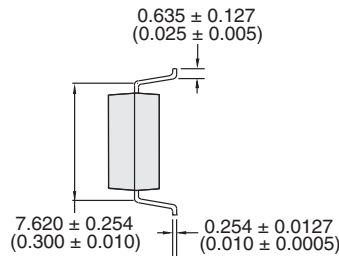
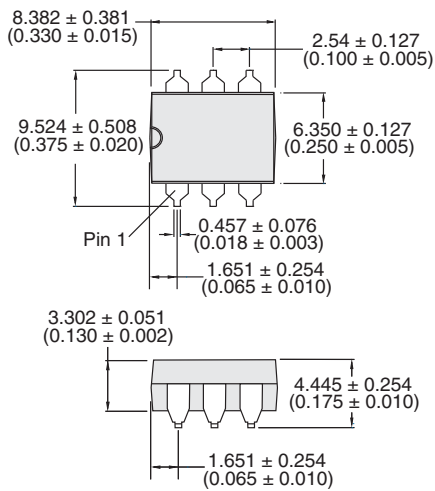

PCB Land Pattern

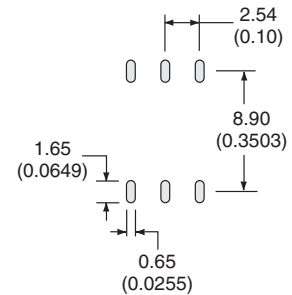

Dimensions
mm
(inches)

PLA110STR Tape & Reel

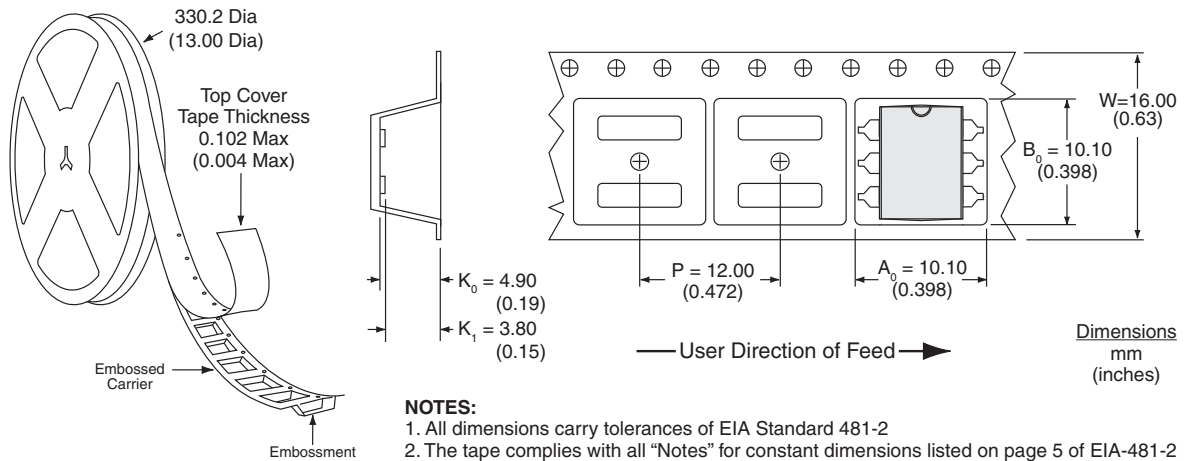

For additional information please visit our website at: www.ixysic.com

IXYS Integrated Circuits Division makes no representations or warranties with respect to the accuracy or completeness of the contents of this publication and reserves the right to make changes to specifications and product descriptions at any time without notice. Neither circuit patent licenses nor indemnity are expressed or implied. Except as set forth in IXYS Integrated Circuits Division's Standard Terms and Conditions of Sale, IXYS Integrated Circuits Division assumes no liability whatsoever, and disclaims any express or implied warranty, relating to its products including, but not limited to, the implied warranty of merchantability, fitness for a particular purpose, or infringement of any intellectual property right.

The products described in this document are not designed, intended, authorized or warranted for use as components in systems intended for surgical implant into the body, or in other applications intended to support or sustain life, or where malfunction of IXYS Integrated Circuits Division's product may result in direct physical harm, injury, or death to a person or severe property or environmental damage. IXYS Integrated Circuits Division reserves the right to discontinue or make changes to its products at any time without notice.

X-ON Electronics

Largest Supplier of Electrical and Electronic Components

Click to view similar products for [Solid State Relays - PCB Mount](#) category:

Click to view products by [IXYS](#) manufacturer:

Other Similar products are found below :

[M86F-2W](#) [M90F-2W](#) [G2-1A07-ST](#) [G2-1A07-TT](#) [G2-1B02-TT](#) [G2-DA06-ST](#) [G3CN-202PL-3-US DC12](#) [G3CN-203P DC3-28](#)
[G3RDX02SNUSDC12](#) [PLA134S](#) [DMP6202A](#) [DS11-1005](#) [AQ3A2-ZT432VDC](#) [AQV212J](#) [AQV214SD02](#) [AQV252GAJ](#) [AQW414EA](#)
[AQY221N2SJ](#) [AQY221R2SJ](#) [EFR1200480A150](#) [LCA220](#) [LCB110S](#) [1618400-5](#) [SR75-1ST](#) [AQV112KLJ](#) [AQV212AJ](#) [AQV238AD01](#)
[AQV252GAXJ](#) [AQW414TS](#) [AQY210SXT](#) [AQY214SXT](#) [AQY221N2V1YJ](#) [AQY221R2VJ](#) [G2-1A02-ST](#) [G2-1A02-TT](#) [G2-1A03-ST](#) [G2-1A03-TT](#) [G2-1A06-TT](#) [G2-1A23-TT](#) [G2-1B01-ST](#) [G2-1B01-TT](#) [G2-1B02-ST](#) [G2-DA03-ST](#) [G2-DA03-TT](#) [G2-DA06-TT](#) [G3M-203PL-UTU-1 DC24](#) [CPC2330N](#) [3-1617776-2](#) [CTA2425](#) [TS190](#)