



Parameter	Rating	Units
Blocking Voltage	800	$V_P$
Load Current	100	$mA_{rms}$
	85	$mA_{DC}$
On-Resistance (max)	50	$\Omega$
Input Control Current	2	mA

### Features

- Guaranteed Specifications at 105°C
- -40°C to +105°C Operational Temperature Range
- 5mA Input Control Current Over Operating Temperature Range
- 800V<sub>P</sub> Blocking Voltage
- 6.8mm Pad-to-Pad Separation of Output Pins
- 5000V<sub>rms</sub> Input/Output Isolation
- Small Surface Mount Package
- No EMI/RFI Generation
- Flammability Rating UL 94 V-0

### Applications

- Industrial Controls
- Instrumentation
- Multiplexers
- Data Acquisition
- Electronic Switching
- I/O Subsystems
- Meters (Watt-Hour, Water, Gas)
- Medical Equipment—Patient/Equipment Isolation

### Description

IXYS Integrated Circuits' PLA172P is a single-pole, normally-open (1-Form-A) Solid State Relay, rated for operation up to 105°C, that uses optically coupled MOSFET technology to provide an enhanced input to output isolation of 5000V<sub>rms</sub>.

The unique device pinout provides more than 6.8mm of pad-to-pad separation between the high voltage output pins.

Control of the optically coupled output is by the input infrared LED. The PLA172P is designed to replace electromechanical relays, and provides bounce-free switching in a compact, surface-mount package.

### Approvals

- UL Recognized Component: File # E76270
- TUV EN 62368-1: Certificate # B 082667 0008

### Ordering Information

Part #	Description
PLA172P	6-Pin (8-Pin Body) Flatpack (50/Tube)
PLA172PTR	6-Pin (8-Pin Body) Flatpack, Tape & Reel (1000/Reel)

### Pin Configuration

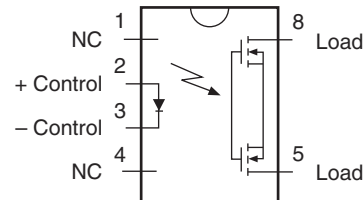

### Switching Characteristics of Normally-Open Devices

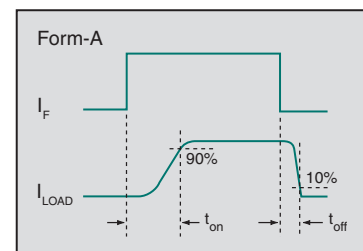

### Absolute Maximum Ratings (@ 25°C Unless otherwise noted)

Parameter	Ratings	Units
Blocking Voltage (-40°C to +105°C)	800	V <sub>P</sub>
Reverse Input Voltage	5	V
Input Control Current	50	mA
Peak (10ms)	1	A
Input Power Dissipation <sup>1</sup>	150	mW
Output Power Dissipation		
AC Load Current <sup>2</sup>	890	mW
DC Load Current <sup>3</sup>	667	
Isolation Voltage, Input to Output (60 Seconds)	5000	V <sub>rms</sub>
Operational Temperature, Ambient	-40 to +105	°C
Storage Temperature	-40 to +125	°C

<sup>1</sup> Derate linearly 1.33 mW / °C

<sup>2</sup> Derate output power linearly 8.9 mW / °C

<sup>3</sup> Derate output power linearly 6.67 mW / °C

Absolute Maximum Ratings are stress ratings. Stresses in excess of these ratings can cause permanent damage to the device. Functional operation of the device at conditions beyond those indicated in the operational sections of this data sheet is not implied.

Typical values are characteristic of the device at the specified temperatures and are the result of engineering evaluations. They are provided for information purposes only and are not part of the manufacturing testing requirements.

### Electrical Characteristics

Parameter	Conditions	Symbol	Min	Typ	Max	Units
<b>Output Characteristics @ 25°C</b>						
Blocking Voltage	I <sub>L</sub> =1μA	V <sub>DRM</sub>	800	-	-	V <sub>P</sub>
Load Current						
Continuous, AC <sup>1</sup>	I <sub>F</sub> =2mA	I <sub>L</sub>	-	-	100	mA <sub>rms</sub>
Continuous, DC <sup>2</sup>			-	-	85	mA <sub>DC</sub>
Peak			I <sub>F</sub> =2mA, t=10ms	I <sub>LPK</sub>	-	-
On-Resistance <sup>3</sup>	I <sub>F</sub> =2mA, I <sub>L</sub> =100mA	R <sub>ON</sub>	-	37	50	Ω
	I <sub>F</sub> =2mA, I <sub>L</sub> =1mA		-	57	85	
Off-State Leakage Current	V <sub>L</sub> =800V	I <sub>LEAK</sub>	-	-	1	μA
Switching Speeds						
Turn-On	I <sub>F</sub> =5mA, I <sub>L</sub> =100mA	t <sub>on</sub>	-	1.2	5	ms
Turn-Off		t <sub>off</sub>	-	0.5	5	
Output Capacitance	I <sub>F</sub> =0mA, V <sub>L</sub> =20V, f=1MHz	C <sub>OUT</sub>	-	10	-	pF
<b>Output Characteristics @ 105°C</b>						
On-Resistance <sup>3</sup>	I <sub>F</sub> =5mA, I <sub>L</sub> =30mA	R <sub>ON</sub>	-	70	110	Ω
	I <sub>F</sub> =5mA, I <sub>L</sub> =1mA		-	110	140	
Off-State Leakage Current	V <sub>L</sub> =800V	I <sub>LEAK</sub>	-	-	5	μA
Switching Speeds						
Turn-On	I <sub>F</sub> =5mA, I <sub>L</sub> =30mA	t <sub>on</sub>	-	-	10	ms
Turn-Off		t <sub>off</sub>	-	-	10	
<b>Input Characteristics @ 25°C</b>						
Input Control Current to Activate <sup>4</sup>	I <sub>L</sub> =100mA	I <sub>F</sub>	-	0.35	2	mA
Input Control Current to Deactivate	-	I <sub>F</sub>	0.05	-	-	mA
Input Voltage Drop	I <sub>F</sub> =5mA	V <sub>F</sub>	0.9	1.36	1.5	V
Reverse Input Current	V <sub>R</sub> =5V	I <sub>R</sub>	-	-	10	μA
<b>Input Characteristics @ 105°C</b>						
Input Control Current to Activate	I <sub>L</sub> =30mA	I <sub>F</sub>	-	-	5	mA
<b>Common Characteristics @ 25°C</b>						
Input to Output Capacitance	V <sub>IO</sub> =0V, f=1MHz	C <sub>IO</sub>	-	1	-	pF

<sup>1</sup> Load derates linearly from 100mA @ 25°C to 44mA @ 105°C (0.7mA/°C).

<sup>2</sup> Load derates linearly from 85mA @ 25°C to 38mA @ 105°C (0.59mA/°C).

<sup>3</sup> Measurement taken within 1 second of on-time.

<sup>4</sup> For applications requiring high temperature operation (greater than 60°C) a minimum LED drive current of 5mA is recommended.

**PERFORMANCE DATA\***

**Typical LED Forward Voltage Drop**  
(N=50,  $I_F=5\text{mA}$ )

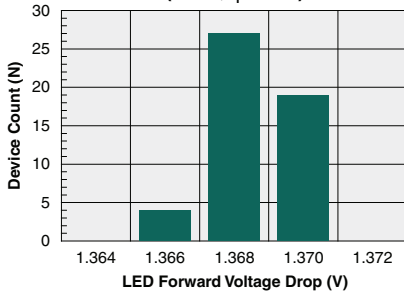

**Typical  $I_F$  for Switch Operation**  
(N=50,  $I_L=100\text{mA}$ )

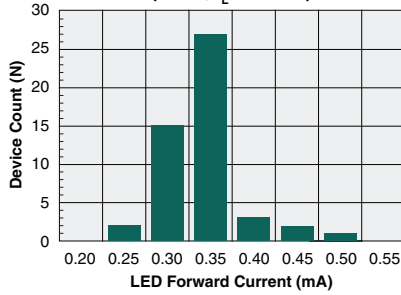

**Typical  $I_F$  for Switch Dropout**  
(N=50,  $I_L=100\text{mA}$ )

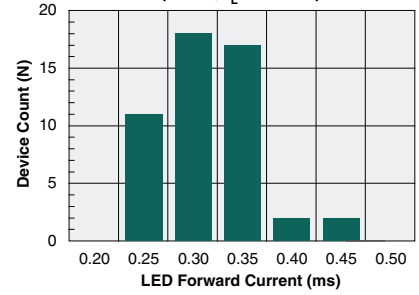

**Typical On-Resistance**  
(N=50,  $I_F=5\text{mA}$ ,  $I_L=1\text{mA}$ )

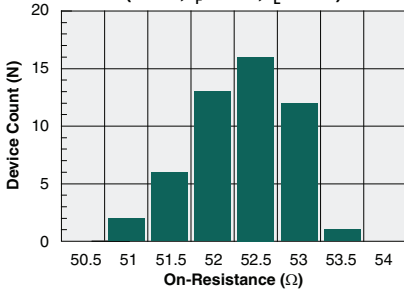

**Typical Turn-On Time**  
(N=50,  $I_F=5\text{mA}$ ,  $I_L=100\text{mA}$ )

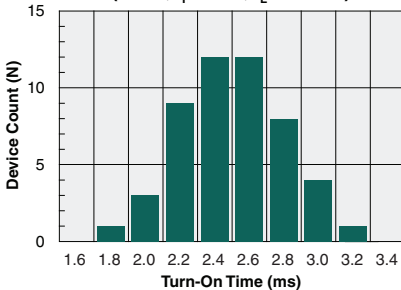

**Typical Turn-Off Time**  
(N=50,  $I_F=5\text{mA}$ ,  $I_L=100\text{mA}$ )

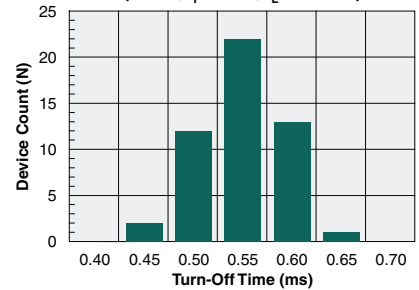

**Typical On-Resistance**  
(N=50,  $I_F=5\text{mA}$ ,  $I_L=100\text{mA}$ )

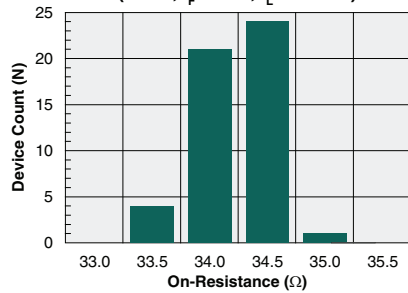

**Typical Blocking Voltage Distribution**  
(N=50)

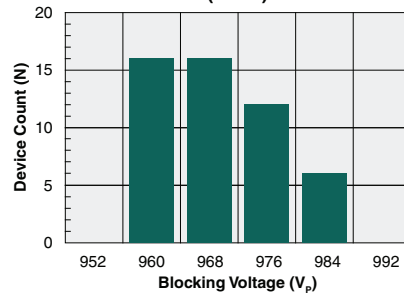

**Typical LED Forward Voltage Drop vs. Temperature**

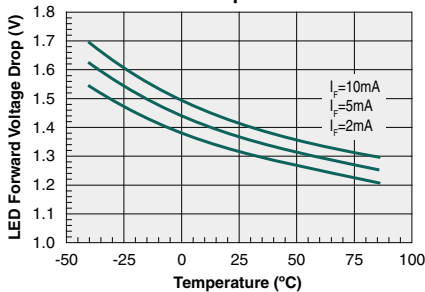

**Turn-On Time vs. LED Forward Current**  
( $I_L=100\text{mA}$ )

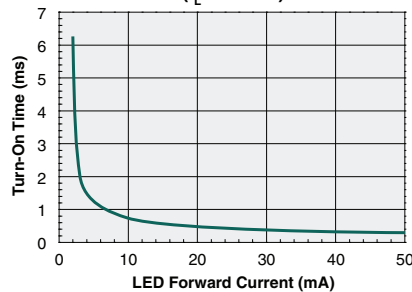

**Turn-Off Time vs. LED Forward Current**  
( $I_L=100\text{mA}$ )

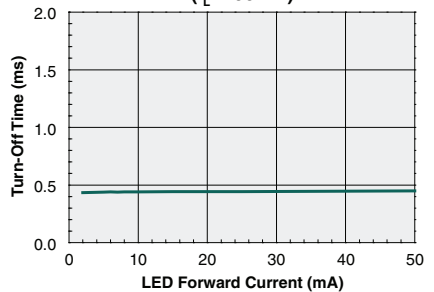

\*Unless otherwise noted, data presented in these graphs is typical of device operation at 25°C.

**PERFORMANCE DATA\***

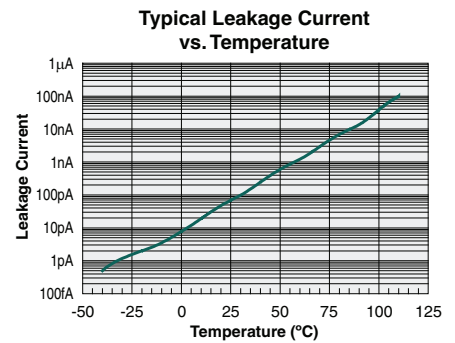
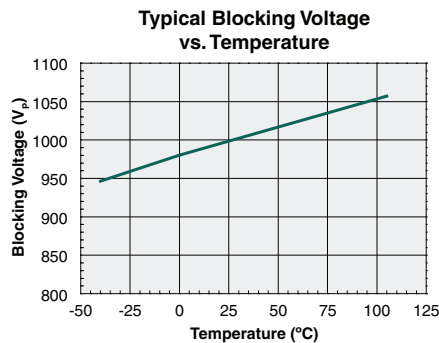
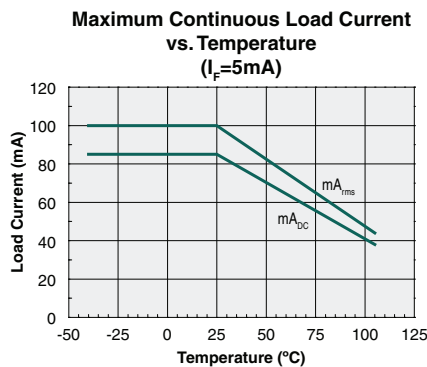
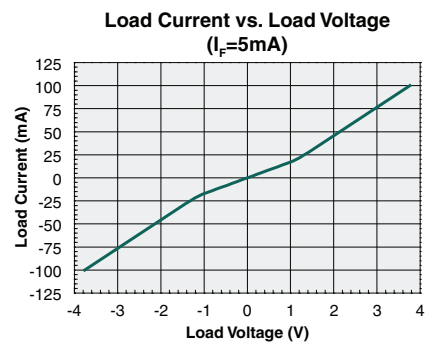
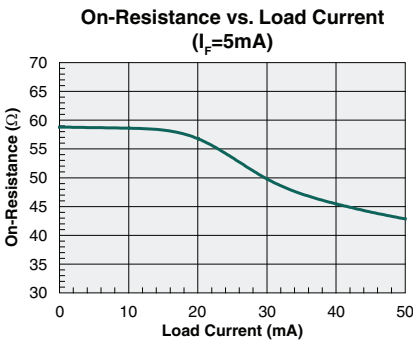
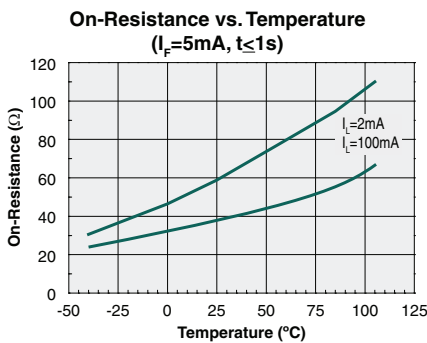
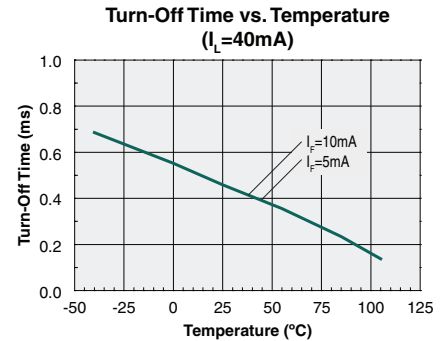
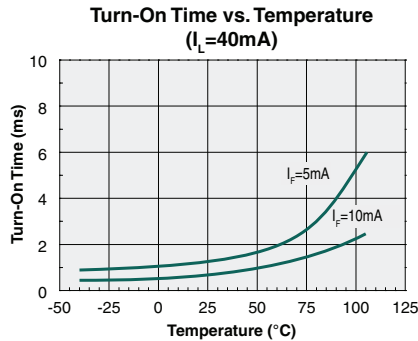
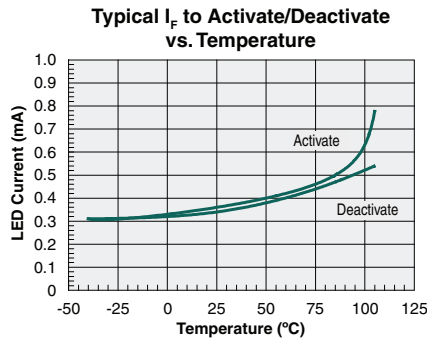

\*Unless otherwise noted, data presented in these graphs is typical of device operation at 25°C.

## Manufacturing Information

### Moisture Sensitivity



All plastic encapsulated semiconductor packages are susceptible to moisture ingress. IXYS Integrated Circuits classifies its plastic encapsulated devices for moisture sensitivity according to the latest version of the joint industry standard, **IPC/JEDEC J-STD-020**, in force at the time of product evaluation. We test all of our products to the maximum conditions set forth in the standard, and guarantee proper operation of our devices when handled according to the limitations and information in that standard as well as to any limitations set forth in the information or standards referenced below.

Failure to adhere to the warnings or limitations as established by the listed specifications could result in reduced product performance, reduction of operable life, and/or reduction of overall reliability.

This product carries a **Moisture Sensitivity Level (MSL)** classification as shown below, and should be handled according to the requirements of the latest version of the joint industry standard **IPC/JEDEC J-STD-033**.

Device	Moisture Sensitivity Level (MSL) Classification
PLA172P	MSL 1

### ESD Sensitivity



This product is ESD Sensitive, and should be handled according to the industry standard **JESD-625**.

### Soldering Profile

Provided in the table below is the **IPC/JEDEC J-STD-020** Classification Temperature ( $T_C$ ) and the maximum total dwell time ( $t_p$ ) in all reflow processes that the body temperature of these surface mount devices may be ( $T_C - 5$ )°C or greater. The device's body temperature must not exceed the Classification Temperature at any time during reflow soldering processes.

Device	Classification Temperature ( $T_C$ )	Dwell Time ( $t_p$ )	Max Reflow Cycles
PLA172P	250°C	30 seconds	3

### Board Wash

IXYS Integrated Circuits recommends the use of no-clean flux formulations. Board washing to reduce or remove flux residue following the solder reflow process is acceptable provided proper precautions are taken to prevent damage to the device. These precautions include but are not limited to: using a low pressure wash and providing a follow up bake cycle sufficient to remove any moisture trapped within the device due to the washing process. Due to the variability of the wash parameters used to clean the board, determination of the bake temperature and duration necessary to remove the moisture trapped within the package is the responsibility of the user (assembler). Cleaning or drying methods that employ ultrasonic energy may damage the device and should not be used. Additionally, the device must not be exposed to halide flux or solvents.



### Mechanical Dimensions

#### PLA172P Package

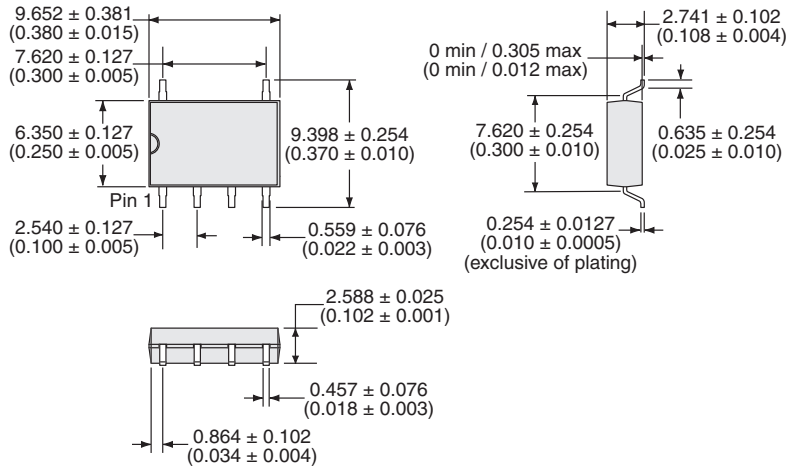

#### PCB Land Pattern

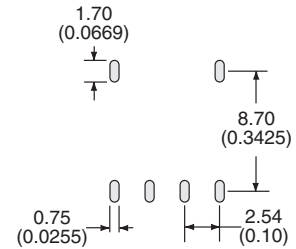

Dimensions  
mm  
(inches)

#### PLA172PTR Tape & Reel

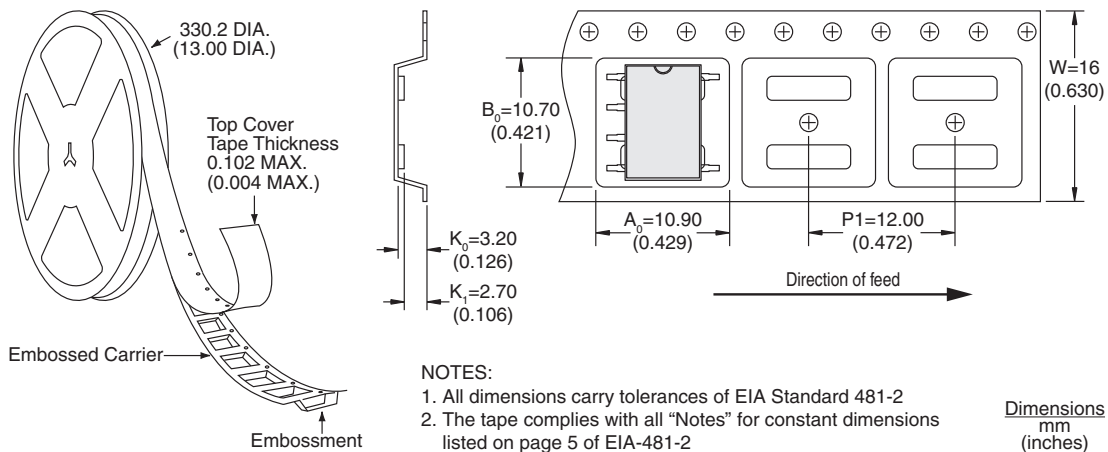

Dimensions  
mm  
(inches)

For additional information please visit our website at: <https://www.ixysic.com>

## X-ON Electronics

Largest Supplier of Electrical and Electronic Components

*Click to view similar products for [Solid State Relays - PCB Mount](#) category:*

*Click to view products by [IXYS](#) manufacturer:*

Other Similar products are found below :

[M86F-2W](#) [M90F-2Y](#) [G2-1A07-ST](#) [G2-1A07-TT](#) [G2-1B02-TT](#) [G2-DA06-ST](#) [923812OCAS](#) [PLA134S](#) [DS11-1005](#) [AQH3213J](#) [AQV212J](#)  
[AQY412EHAJ](#) [EFR1200480A150](#) [901-7](#) [LCA220](#) [LCB110S](#) [1618400-5](#) [SR75-1ST](#) [AQH2213AJ](#) [AQV112KLJ](#) [AQV212AJ](#) [AQV212SXJ](#)  
[AQV238AD01](#) [AQW414TS](#) [AQY221N2SYD01](#) [AQY221R2VJ](#) [AQY275AXJ](#) [AQY414SXE01](#) [G2-1A02-ST](#) [G2-1A03-ST](#) [G2-1A03-TT](#)  
[G2-1A05-ST](#) [G2-1A06-TT](#) [G2-1A23-TT](#) [G2-1B01-ST](#) [G2-1B01-TT](#) [G2-1B02-ST](#) [G2-DA03-ST](#) [G2-DA03-TT](#) [G2-DA06-TT](#) [CPC1333GR](#)  
[3-1617776-2](#) [CTA2425](#) [TLP3131\(F\)](#) [LBA110S](#) [LBB110S](#) [LCA110LSTR](#) [LCB126S](#) [WPPM-0626D](#) [WPPM-3526D](#)