

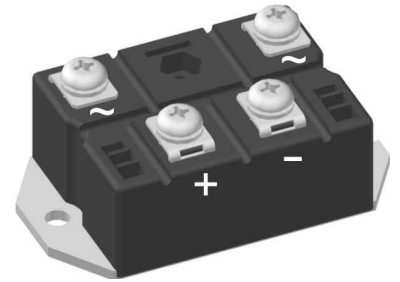
# Standard Rectifier Module

<b>1~ Rectifier</b>
$V_{RRM} = 1800\text{ V}$
$I_{DAV} = 160\text{ A}$
$I_{FSM} = 2800\text{ A}$

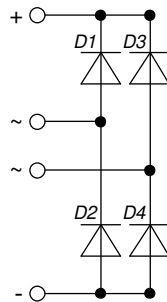
## 1~ Rectifier Bridge

Part number

**VBO160-18NO7**



 E72873



### Features / Advantages:

- Package with DCB ceramic
- Improved temperature and power cycling
- Planar passivated chips
- Very low forward voltage drop
- Very low leakage current

### Applications:

- Diode for main rectification
- For one phase bridge configurations
- Supplies for DC power equipment
- Input rectifiers for PWM inverter
- Battery DC power supplies
- Field supply for DC motors

### Package: PWS-E

- Isolation Voltage: 3000 V~
- Industry standard outline
- RoHS compliant
- Easy to mount with two screws
- Base plate: Copper internally DCB isolated
- Advanced power cycling

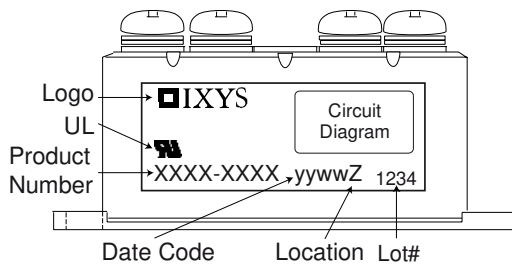
### Disclaimer Notice

Information furnished is believed to be accurate and reliable. However, users should independently evaluate the suitability of and test each product selected for their own applications. Littelfuse products are not designed for, and may not be used in, all applications. Read complete Disclaimer Notice at [www.littelfuse.com/disclaimer-electronics](http://www.littelfuse.com/disclaimer-electronics).

Rectifier				Ratings			
Symbol	Definition	Conditions		min.	typ.	max.	Unit
$V_{RSM}$	max. non-repetitive reverse blocking voltage					1900	V
$V_{RRM}$	max. repetitive reverse blocking voltage					1800	V
$I_R$	reverse current	$V_R = 1800$ V	$T_{VJ} = 25^\circ\text{C}$			200	$\mu\text{A}$
		$V_R = 1800$ V	$T_{VJ} = 150^\circ\text{C}$			3.5	mA
$V_F$	forward voltage drop	$I_F = 160$ A	$T_{VJ} = 25^\circ\text{C}$			1.07	V
		$I_F = 320$ A				1.22	V
		$I_F = 160$ A	$T_{VJ} = 125^\circ\text{C}$			0.96	V
		$I_F = 320$ A				1.15	V
$I_{DAV}$	bridge output current	$T_C = 110^\circ\text{C}$ rectangular	$T_{VJ} = 150^\circ\text{C}$ d = 0.5			160	A
$V_{F0}$	threshold voltage	} for power loss calculation only				0.74	V
$r_F$	slope resistance					2.4	m $\Omega$
$R_{thJC}$	thermal resistance junction to case					0.4	K/W
$R_{thCH}$	thermal resistance case to heatsink				0.15		K/W
$P_{tot}$	total power dissipation			$T_C = 25^\circ\text{C}$		310	W
$I_{FSM}$	max. forward surge current	t = 10 ms; (50 Hz), sine	$T_{VJ} = 45^\circ\text{C}$			2.80	kA
		t = 8,3 ms; (60 Hz), sine	$V_R = 0$ V			3.03	kA
		t = 10 ms; (50 Hz), sine	$T_{VJ} = 150^\circ\text{C}$			2.38	kA
		t = 8,3 ms; (60 Hz), sine	$V_R = 0$ V			2.57	kA
$I^2t$	value for fusing	t = 10 ms; (50 Hz), sine	$T_{VJ} = 45^\circ\text{C}$			39.2	kA <sup>2</sup> s
		t = 8,3 ms; (60 Hz), sine	$V_R = 0$ V			38.1	kA <sup>2</sup> s
		t = 10 ms; (50 Hz), sine	$T_{VJ} = 150^\circ\text{C}$			28.3	kA <sup>2</sup> s
		t = 8,3 ms; (60 Hz), sine	$V_R = 0$ V			27.5	kA <sup>2</sup> s
$C_J$	junction capacitance	$V_R = 400$ V; f = 1 MHz		$T_{VJ} = 25^\circ\text{C}$		133	pF



Package PWS-E		Ratings				
Symbol	Definition	Conditions	min.	typ.	max.	Unit
$I_{RMS}$	RMS current	per terminal			250	A
$T_{VJ}$	virtual junction temperature		-40		150	°C
$T_{op}$	operation temperature		-40		125	°C
$T_{stg}$	storage temperature		-40		125	°C
<b>Weight</b>				273		g
$M_D$	mounting torque		4.25		5.75	Nm
$M_T$	terminal torque		4.25		5.75	Nm
$d_{Spp/App}$	creepage distance on surface   striking distance through air	terminal to terminal	12.0			mm
$d_{Spb/Apb}$		terminal to backside	26.0			mm
$V_{ISOL}$	isolation voltage	t = 1 second	3000			V
		t = 1 minute	2500			V



Ordering	Ordering Number	Marking on Product	Delivery Mode	Quantity	Code No.
Standard	VBO160-18NO7	VBO160-18NO7	Box	5	484024

**Equivalent Circuits for Simulation**

\* on die level

$T_{VJ} = 150^{\circ}C$

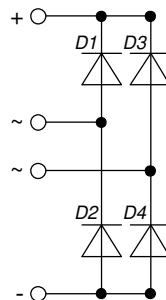
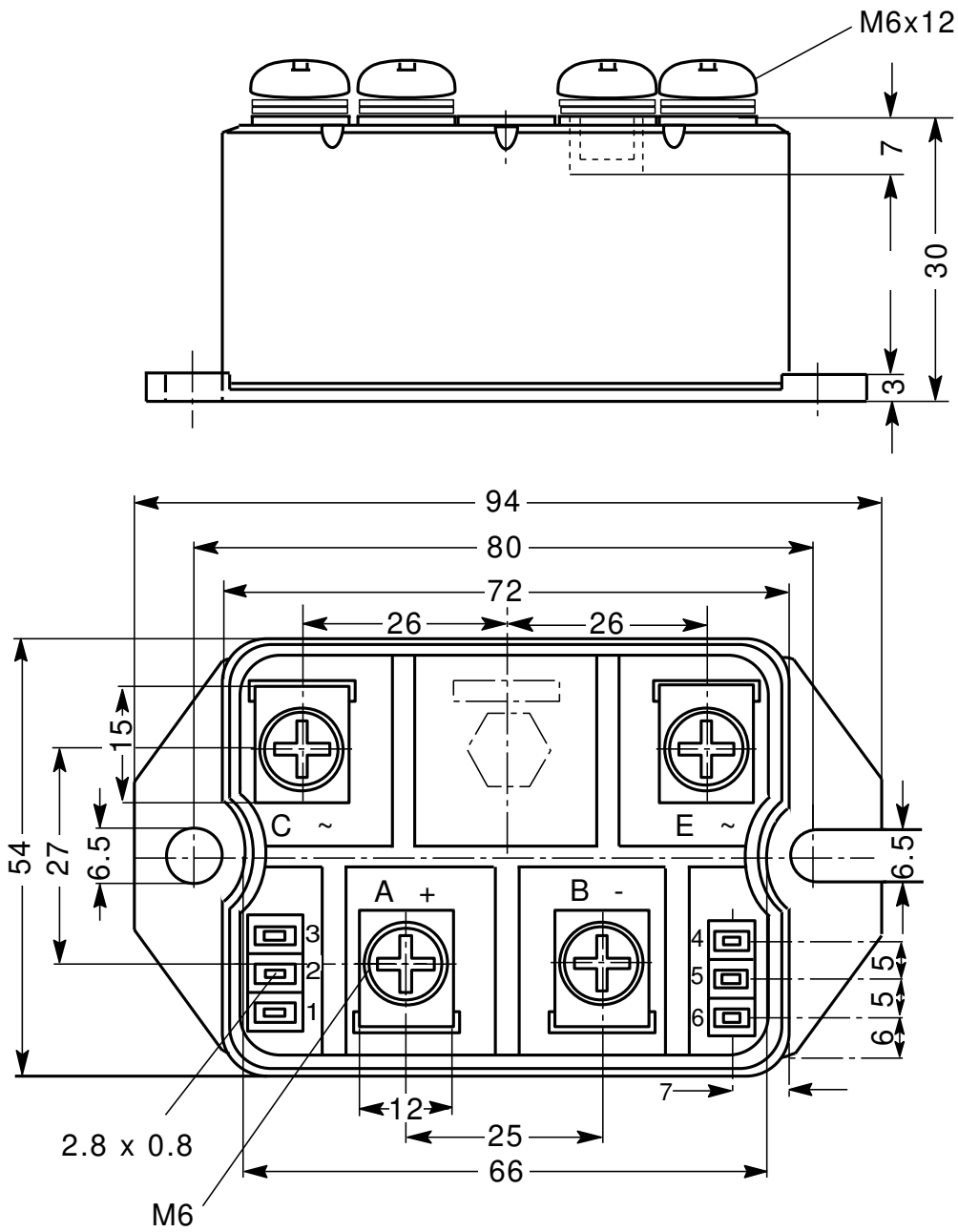


**Rectifier**

$V_{0\ max}$	threshold voltage	0.74	V
$R_{0\ max}$	slope resistance *	1.2	mΩ



Outlines PWS-E



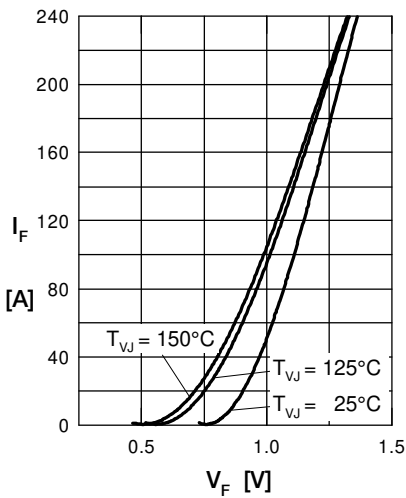
**Rectifier**


Fig. 1 Forward current vs. voltage drop per diode

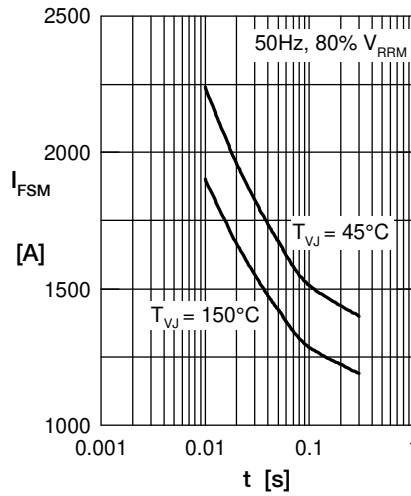


Fig. 2 Surge overload current vs. time per diode

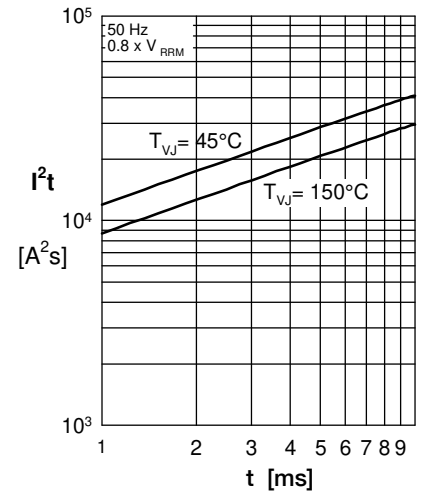
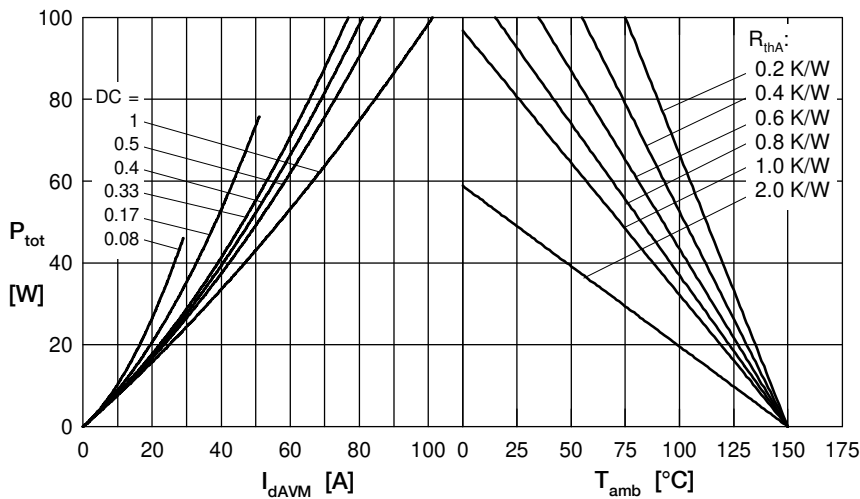

 Fig. 3  $I^2t$  vs. time per diode


Fig. 4 Power dissipation vs. forward current and ambient temperature per diode

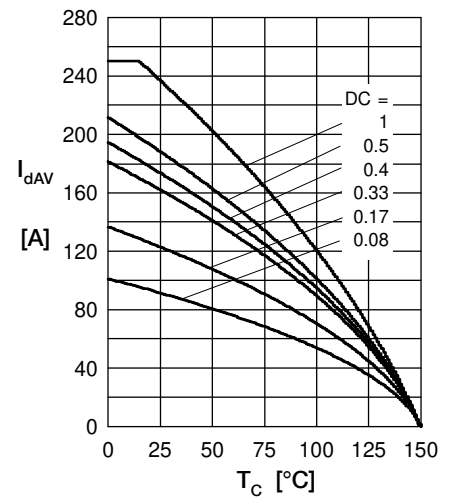


Fig. 5 Max. forward current vs. case temperature per diode

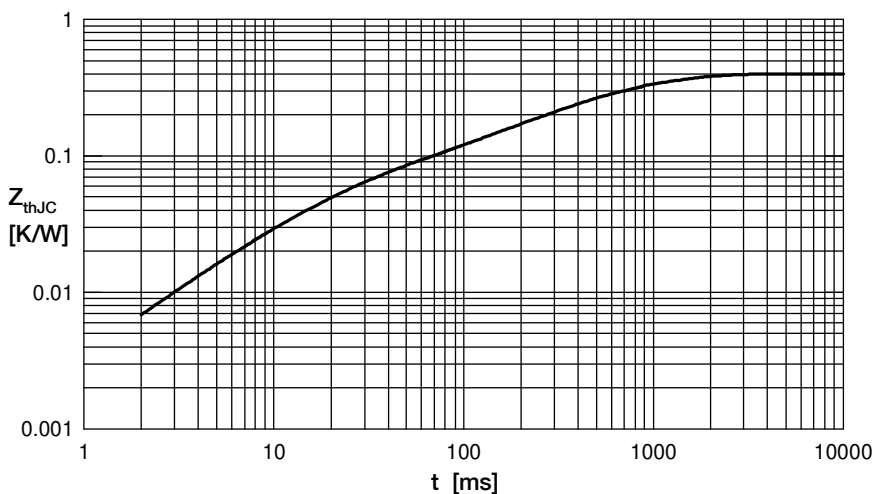


Fig. 6 Transient thermal impedance junction to case vs. time per diode



## **X-ON Electronics**

Largest Supplier of Electrical and Electronic Components

*Click to view similar products for [Bridge Rectifiers](#) category:*

*Click to view products by [IXYS](#) manufacturer:*

Other Similar products are found below :

[IXYS](#)