

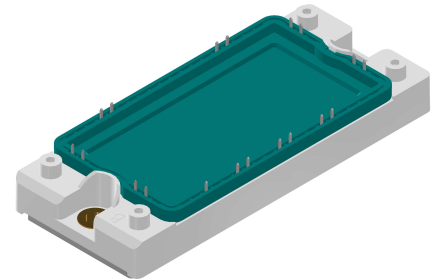
# High Voltage Standard Rectifier Module

3~ Rectifier	Brake Chopper
$V_{RRM} = 2200 \text{ V}$	$V_{CES} = 1700 \text{ V}$
$I_{DAV} = 150 \text{ A}$	$I_{C25} = 113 \text{ A}$
$I_{FSM} = 1100 \text{ A}$	$V_{CE(sat)} = 1.9 \text{ V}$

3~ Rectifier Bridge + Brake Unit + NTC

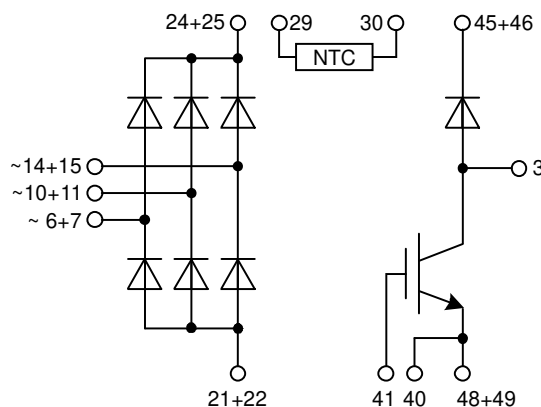
Part number

**VUB135-22NO1**



Backside: isolated

 E72873



## Features / Advantages:

- Package with DCB ceramic
- Improved temperature and power cycling
- Planar passivated chips
- Very low forward voltage drop
- Very low leakage current
- NTC

## Applications:

- 3~ Rectifier with brake unit for drive inverters

## Package: E2-Pack

- Isolation Voltage: 3600 V~
- Industry standard outline
- RoHS compliant
- Soldering pins for PCB mounting
- Height: 17 mm
- Base plate: Copper internally DCB isolated
- Advanced power cycling
- Phase Change Material available

## Disclaimer Notice

Information furnished is believed to be accurate and reliable. However, users should independently evaluate the suitability of and test each product selected for their own applications. Littelfuse products are not designed for, and may not be used in, all applications. Read complete Disclaimer Notice at [www.littelfuse.com/disclaimer-electronics](http://www.littelfuse.com/disclaimer-electronics).

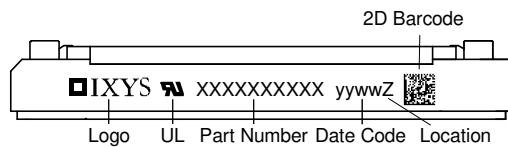


Rectifier				Ratings			
Symbol	Definition	Conditions		min.	typ.	max.	Unit
$V_{RSM}$	max. non-repetitive reverse blocking voltage					2300	V
$V_{RRM}$	max. repetitive reverse blocking voltage					2200	V
$I_R$	reverse current	$V_R = 2200$ V		$T_{VJ} = 25^\circ\text{C}$		100	$\mu\text{A}$
		$V_R = 2200$ V		$T_{VJ} = 150^\circ\text{C}$		2	mA
$V_F$	forward voltage drop	$I_F = 50$ A		$T_{VJ} = 25^\circ\text{C}$		1.20	V
		$I_F = 150$ A				1.68	V
		$I_F = 50$ A		$T_{VJ} = 125^\circ\text{C}$		1.13	V
		$I_F = 150$ A				1.74	V
$I_{DAV}$	bridge output current	$T_C = 105^\circ\text{C}$	rectangular	$T_{VJ} = 150^\circ\text{C}$		150	A
$V_{FO}$	threshold voltage	} for power loss calculation only		$T_{VJ} = 150^\circ\text{C}$		0.79	V
$r_F$	slope resistance					6.4	m $\Omega$
$R_{thJC}$	thermal resistance junction to case					0.5	K/W
$R_{thCH}$	thermal resistance case to heatsink				0.1		K/W
$P_{tot}$	total power dissipation			$T_C = 25^\circ\text{C}$		250	W
$I_{FSM}$	max. forward surge current	$t = 10$ ms; (50 Hz), sine		$T_{VJ} = 45^\circ\text{C}$		1.10	kA
		$t = 8,3$ ms; (60 Hz), sine		$V_R = 0$ V		1.19	kA
		$t = 10$ ms; (50 Hz), sine		$T_{VJ} = 150^\circ\text{C}$		935	A
		$t = 8,3$ ms; (60 Hz), sine		$V_R = 0$ V		1.01	kA
$I^2t$	value for fusing	$t = 10$ ms; (50 Hz), sine		$T_{VJ} = 45^\circ\text{C}$		6.05	kA <sup>2</sup> s
		$t = 8,3$ ms; (60 Hz), sine		$V_R = 0$ V		5.89	kA <sup>2</sup> s
		$t = 10$ ms; (50 Hz), sine		$T_{VJ} = 150^\circ\text{C}$		4.37	kA <sup>2</sup> s
		$t = 8,3$ ms; (60 Hz), sine		$V_R = 0$ V		4.25	kA <sup>2</sup> s
$C_J$	junction capacitance	$V_R = 400$ V; $f = 1$ MHz		$T_{VJ} = 25^\circ\text{C}$		37	pF



Brake IGBT + Diode				Ratings			
Symbol	Definition	Conditions	min.	typ.	max.	Unit	
$V_{CES}$	collector emitter voltage	$T_{VJ} = 25^{\circ}\text{C}$			1700	V	
$V_{GES}$	max. DC gate voltage				$\pm 20$	V	
$V_{GEM}$	max. transient gate emitter voltage				$\pm 30$	V	
$I_{C25}$	collector current	$T_C = 25^{\circ}\text{C}$			113	A	
$I_{C80}$		$T_C = 80^{\circ}\text{C}$			80	A	
$P_{tot}$	total power dissipation	$T_C = 25^{\circ}\text{C}$			445	W	
$V_{CE(sat)}$	collector emitter saturation voltage	$I_C = 75\text{ A}; V_{GE} = 15\text{ V}$			1.9	V	
					2.8	V	
$V_{GE(th)}$	gate emitter threshold voltage	$I_C = 3\text{ mA}; V_{GE} = V_{CE}$	5.2	5.8	6.4	V	
$I_{CES}$	collector emitter leakage current	$V_{CE} = V_{CES}; V_{GE} = 0\text{ V}$			0.6	mA	
					0.6	mA	
$I_{GES}$	gate emitter leakage current	$V_{GE} = \pm 20\text{ V}$			400	nA	
$Q_{G(on)}$	total gate charge	$V_{CE} = 900\text{ V}; V_{GE} = 15\text{ V}; I_C = 75\text{ A}$		850		nC	
$t_{d(on)}$	turn-on delay time	inductive load $V_{CE} = 900\text{ V}; I_C = 75\text{ A}$ $V_{GE} = \pm 15\text{ V}; R_G = 18\ \Omega$	$T_{VJ} = 125^{\circ}\text{C}$		250	ns	
$t_r$	current rise time				70	ns	
$t_{d(off)}$	turn-off delay time				670	ns	
$t_f$	current fall time				420	ns	
$E_{on}$	turn-on energy per pulse				29	mJ	
$E_{off}$	turn-off energy per pulse				17	mJ	
<b>RBSOA</b>	reverse bias safe operating area	$V_{GE} = \pm 15\text{ V}; R_G = 18\ \Omega$					
$I_{CM}$		$V_{CEK} = 1700\text{ V}$			150	A	
<b>SCSOA</b>	short circuit safe operating area	$V_{CEK} = 1700\text{ V}$					
$t_{SC}$	short circuit duration	$V_{CE} = 900\text{ V}; V_{GE} = \pm 15$			10	$\mu\text{s}$	
$I_{SC}$	short circuit current	$R_G = 18\ \Omega$ ; non-repetitive		340		A	
$R_{thJC}$	thermal resistance junction to case				0.28	K/W	
$R_{thCH}$	thermal resistance case to heatsink				0.10	K/W	
<b>Brake Diode</b>							
$V_{RRM}$	max. repetitive reverse voltage				1700	V	
$I_{F25}$	forward current				75	A	
$I_{F80}$					50	A	
$V_F$	forward voltage	$I_F = 60\text{ A}$			3.05	V	
					2.20	V	
$I_R$	reverse current	$V_R = V_{RRM}$			0.1	mA	
					6	mA	
$Q_{rr}$	reverse recovery charge	$V_R = 900\text{ V}$ $-di_f/dt = 1000\text{ A}/\mu\text{s}$ $I_F = 60\text{ A}; V_{GE} = 0\text{ V}$	$T_{VJ} = 125^{\circ}\text{C}$		18	$\mu\text{C}$	
$I_{RM}$	max. reverse recovery current				70	A	
$t_{rr}$	reverse recovery time				900	ns	
$E_{rec}$	reverse recovery energy				8	mJ	
$R_{thJC}$	thermal resistance junction to case				0.65	K/W	
$R_{thCH}$	thermal resistance case to heatsink				0.25	K/W	

Package E2-Pack			Ratings			
Symbol	Definition	Conditions	min.	typ.	max.	Unit
$I_{RMS}$	RMS current	per terminal			40	A
$T_{VJ}$	virtual junction temperature		-40		150	°C
$T_{op}$	operation temperature		-40		125	°C
$T_{stg}$	storage temperature		-40		125	°C
<b>Weight</b>				176		g
$M_D$	mounting torque		3		6	Nm
$d_{Spp/App}$	creepage distance on surface / striking distance through air	terminal to terminal	6.0			mm
$d_{Spb/Apb}$		terminal to backside	12.0			mm
$V_{ISOL}$	isolation voltage	t = 1 second t = 1 minute	3600 3000			V
		50/60 Hz, RMS; $I_{ISOL} \leq 1$ mA				V



Ordering	Ordering Number	Marking on Product	Delivery Mode	Quantity	Code No.
Standard	VUB135-22NO1	VUB135-22NO1	Box	6	503948

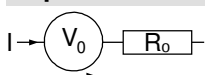
### Temperature Sensor NTC

Symbol	Definition	Conditions	min.	typ.	max.	Unit
$R_{25}$	resistance	$T_{VJ} = 25^\circ$	4.75	5	5.25	k $\Omega$
$B_{25/50}$	temperature coefficient			3375		K

### Equivalent Circuits for Simulation

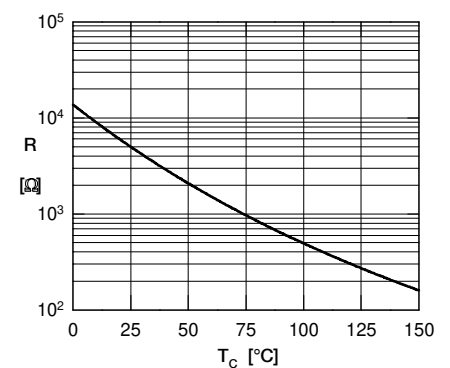
\* on die level

$T_{VJ} = 150^\circ\text{C}$



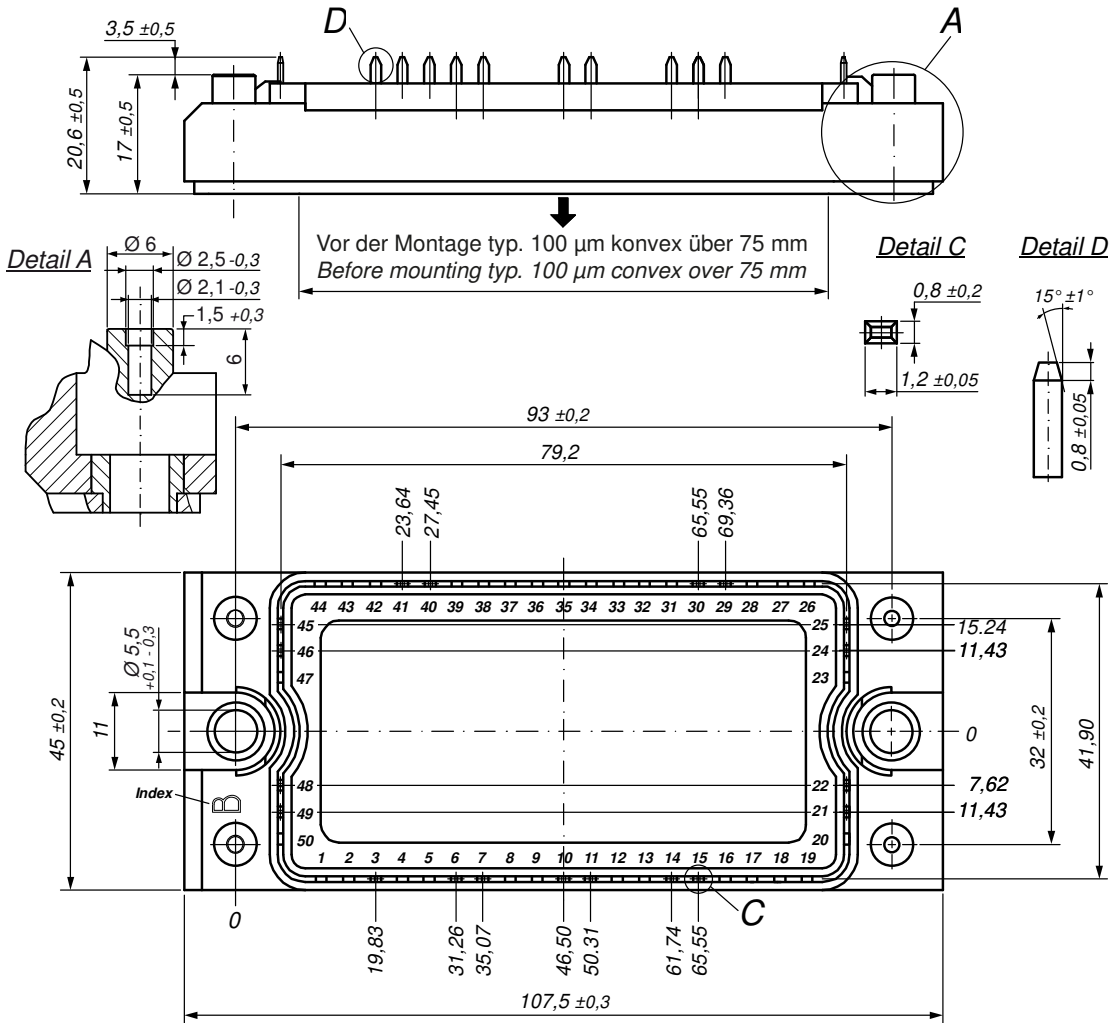
Rectifier

$V_{0 \max}$	threshold voltage	0.79				V
$R_{0 \max}$	slope resistance *	3.3				m $\Omega$





**Outlines E2-Pack**

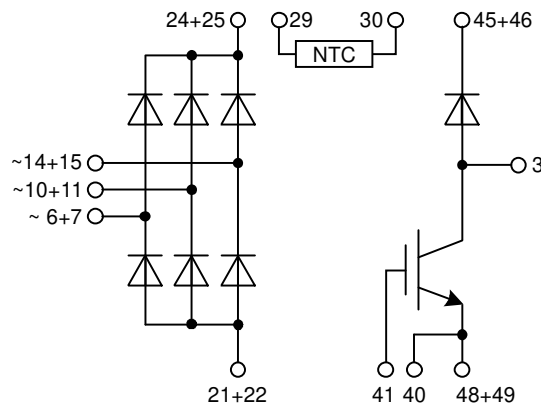


**Bemerkung / Note:**

- Nichttolerierete Maße nach / *Measure without tolerances according DIN ISO 2768-T1-m*
- PCB-Lochmuster / *PCB hole pattern: see pin position*
- Toleranz Pin-Position und PCB-Lochmuster / *Tolerance of pin position and PCB hole pattern:  $\oplus 0.1$*
- Montageanleitung / *Mounting instruction: www.ixys.com Application note IXAN0024*

**Detail A:** PCB-Montage / *Mounting on PCB*

- Empfohlene, selbstschneidende Schraube / *Recommended, self-tapping screw: EJOT PT® (Größe / size: K25)*
- Max. Schraubenlänge / *Max. screw length: PCB-Dicke / thickness + 6 mm (max. Lochtiefe / hole depth)*
- Empfohlenes Drehmoment / *Recommended mounting torque: 1.5 Nm*



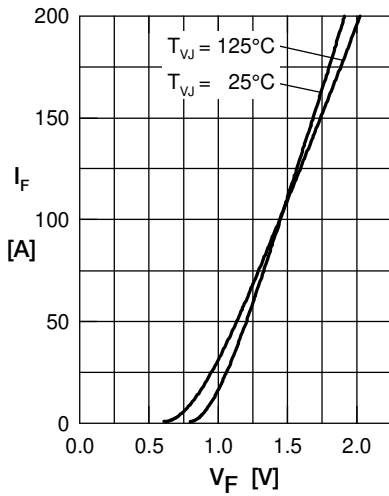
**Rectifier**


Fig. 1 Forward current vs. voltage drop per diode

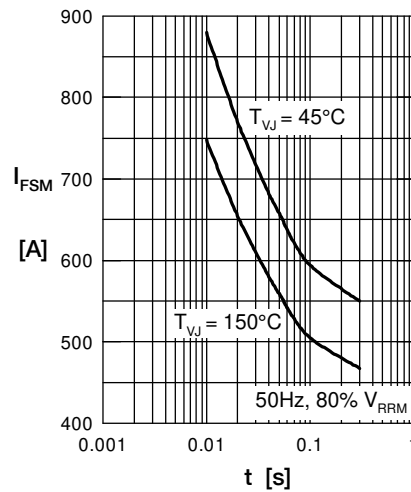


Fig. 2 Surge overload current vs. time per diode

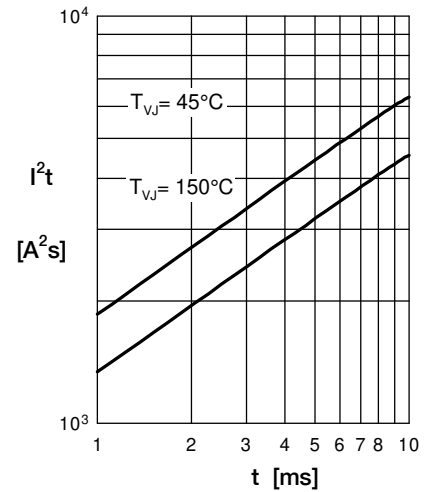
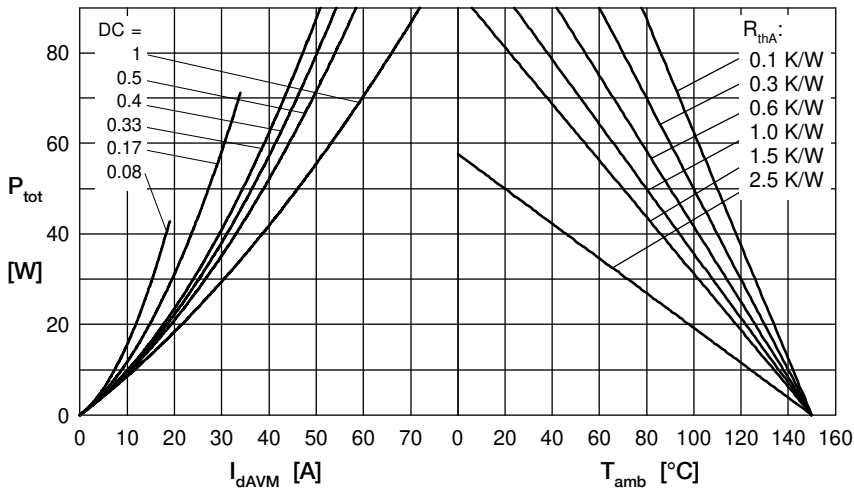

 Fig. 3  $I^2t$  vs. time per diode


Fig. 4 Power dissipation vs. forward current and ambient temperature per diode

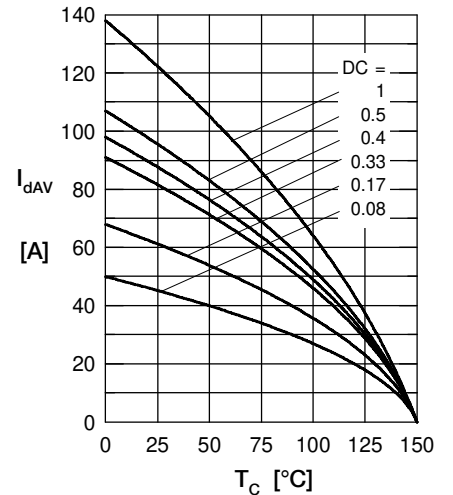


Fig. 5 Max. forward current vs. case temperature per diode

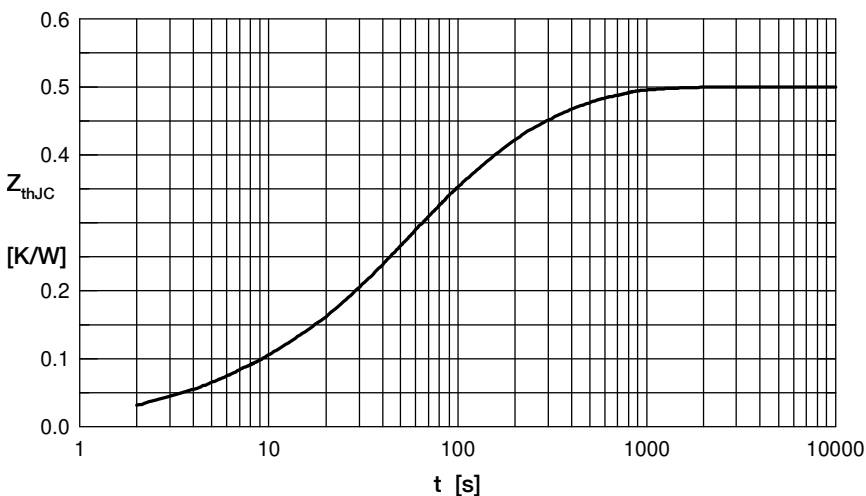


Fig. 6 Transient thermal impedance junction to case vs. time per diode

 Constants for  $Z_{thJC}$  calculation:

i	$R_{th}$ (K/W)	$t_i$ (s)
1	0.040	0.004
2	0.003	0.010
3	0.140	0.030
4	0.120	0.300
5	0.197	0.080

Brake IGBT + Diode

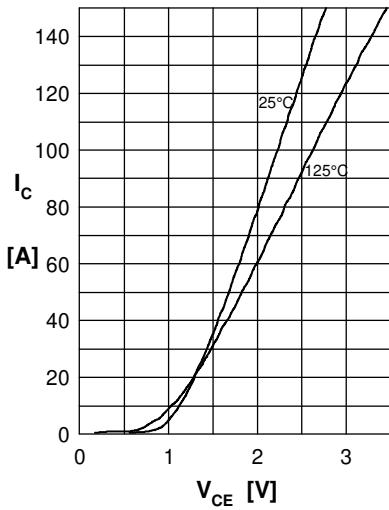


Fig.1 Output characteristics IGBT

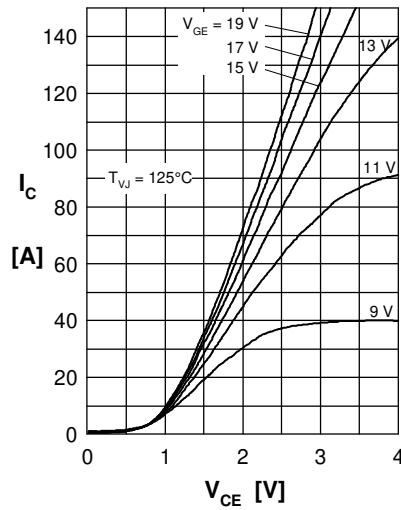


Fig.2 Typ. output characteristics IGBT

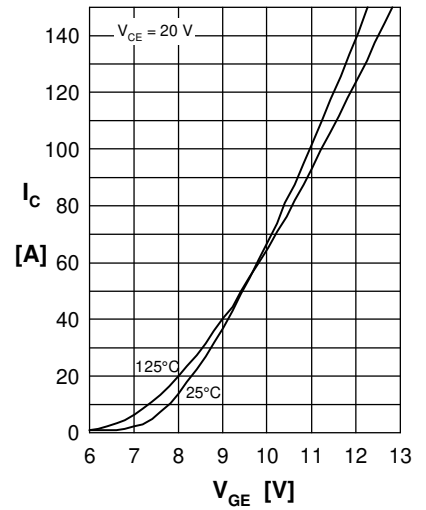


Fig.3 Typ. transfer charact. IGBT

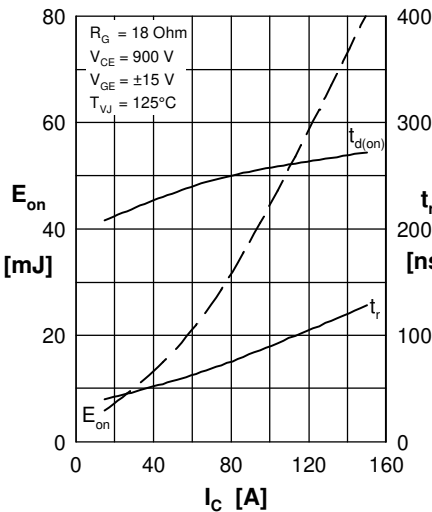


Fig.4 Typ. turn-on energy & switch. times vs. collector current

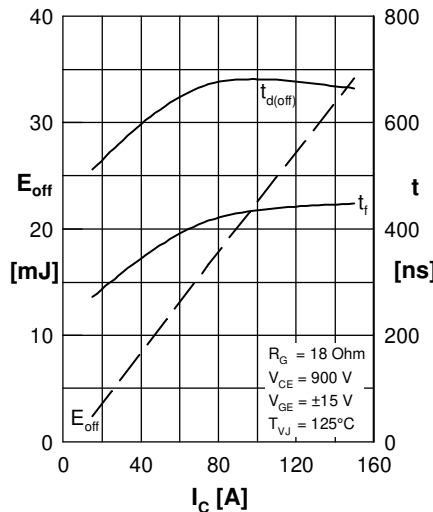


Fig.5 Typ. turn-off energy & switch. times vs. collector current

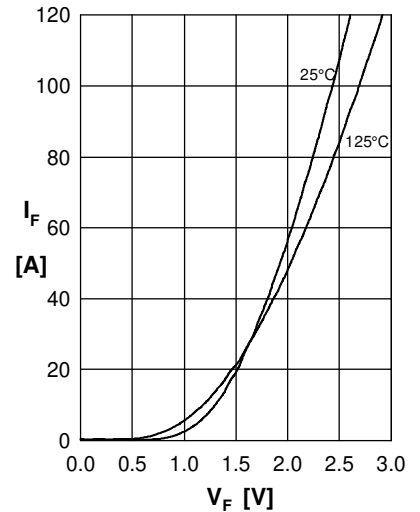


Fig.6 Typ. forward characteristics Diode

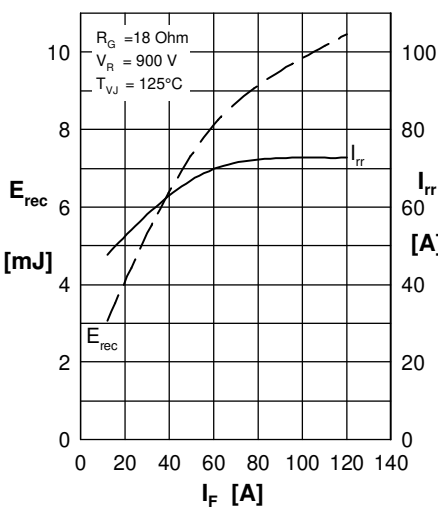


Fig.7 Typ. reverse recovery characteristics Diode

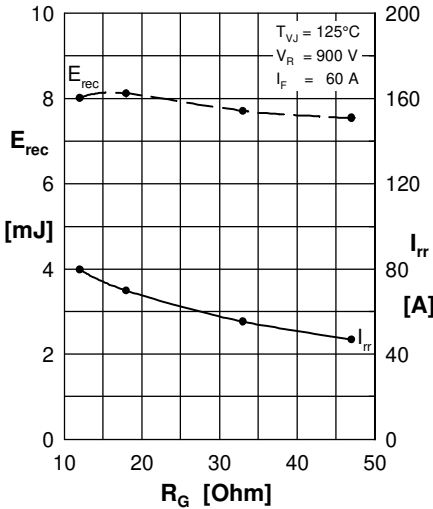


Fig.8 Typ. reverse recovery characteristics Diode

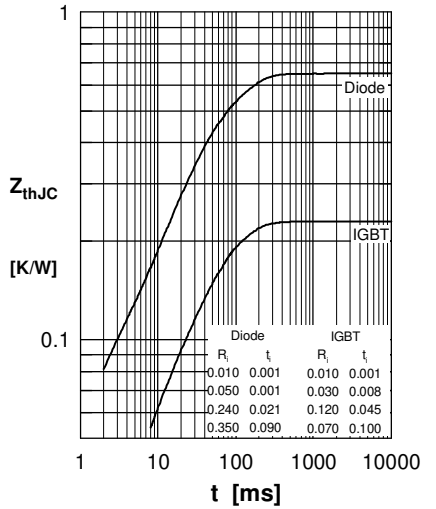


Fig.9 Transient thermal resistance junction to case

## X-ON Electronics

Largest Supplier of Electrical and Electronic Components

*Click to view similar products for [Bridge Rectifiers](#) category:*

*Click to view products by [IXYS](#) manufacturer:*

Other Similar products are found below :

[MB2510](#) [MB252](#) [MB356G](#) [MB358G](#) [GBJ1504-BP](#) [GBU15J-BP](#) [GBU15K-BP](#) [GBU4A-BP](#) [GBU6B-E3/45](#) [GSIB680-E3/45](#) [DB101-BP](#)  
[DF01](#) [DF10SA-E345](#) [BU1508-E3/45](#) [KBPC50-10S](#) [RS405GL-BP](#) [G5SBA60-E3/51](#) [GBU10J-BP](#) [GBU6M](#) [GBU8D-BP](#) [GBU8J-BP](#)  
[2KBB10](#) [36MB140A](#) [TB102M](#) [MB1510](#) [MB258](#) [MB6M-G](#) [MB86](#) [TL401G](#) [MDA920A2](#) [TU602](#) [TU810](#) [MP501W-BP](#) [MP502-BP](#)  
[BR101-BP](#) [BR84DTP204](#) [BU2008-E3/51](#) [KBPC10/15/2501WP](#) [KBPC25-02](#) [VS-2KBB60](#) [DF06SA-E345](#) [DF1510S](#) [VS-40MT160PAPBF](#)  
[W02M](#) [GBL02-E3/45](#) [GBU4G-BP](#) [GBJ2506-BP](#) [GBU6B-E3/51](#) [GSIB15A80-E3/45](#) [DB104-BP](#)