

Phase out

Standard Rectifier Module

PHASE OUT

3~ Rectifier	
V_{RRM}	= 1400 V
I_{DAV}	= 125 A
I_{FSM}	= 1200 A

3~ Rectifier Bridge

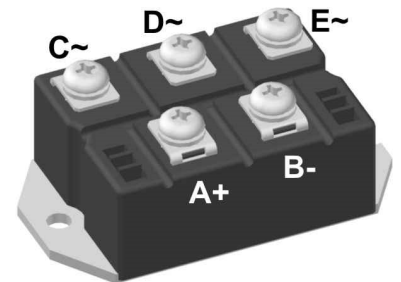
Part number
VUO110-14NO7

E72873

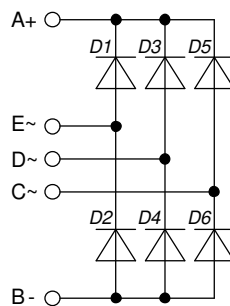
Features / Advantages:

- Package with DCB ceramic
- Improved temperature and power cycling
- Planar passivated chips
- Very low forward voltage drop
- Very low leakage current

Applications:

- Diode for main rectification
- For three phase bridge configurations
- Supplies for DC power equipment
- Input rectifiers for PWM inverter
- Battery DC power supplies
- Field supply for DC motors

Package: PWS-E

- Isolation Voltage: 3000 V~
- Industry standard outline
- RoHS compliant
- Easy to mount with two screws
- Base plate: Copper internally DCB isolated
- Advanced power cycling

Recommended replacement: VUO110-16NO7

Terms and Conditions of Usage

The data contained in this product data sheet is exclusively intended for technically trained staff. The user will have to evaluate the suitability of the product for the intended application and the completeness of the product data with respect to his application. The specifications of our components may not be considered as an assurance of component characteristics. The information in the valid application- and assembly notes must be considered. Should you require product information in excess of the data given in this product data sheet or which concerns the specific application of your product, please contact your local sales office.

Due to technical requirements our product may contain dangerous substances. For information on the types in question please contact your local sales office.

Should you intend to use the product in aviation, in health or life endangering or life support applications, please notify. For any such application we urgently recommend

- to perform joint risk and quality assessments;

- the conclusion of quality agreements;

- to establish joint measures of an ongoing product survey, and that we may make delivery dependent on the realization of any such measures.

Rectifier				Ratings			
Symbol	Definition	Conditions		min.	typ.	max.	Unit
V_{RSM}	max. non-repetitive reverse blocking voltage					1500	V
V_{RRM}	max. repetitive reverse blocking voltage					1400	V
I_R	reverse current	$V_R = 1400$ V	$T_{VJ} = 25^\circ\text{C}$			100	μA
		$V_R = 1400$ V	$T_{VJ} = 150^\circ\text{C}$			2	mA
V_F	forward voltage drop	$I_F = 50$ A	$T_{VJ} = 25^\circ\text{C}$			1.13	V
		$I_F = 150$ A				1.46	V
		$I_F = 50$ A	$T_{VJ} = 125^\circ\text{C}$			1.04	V
		$I_F = 150$ A				1.47	V
I_{DAV}	bridge output current	$T_C = 110^\circ\text{C}$ rectangular	$T_{VJ} = 150^\circ\text{C}$			125	A
V_{FO}	threshold voltage	} for power loss calculation only				0.79	V
r_F	slope resistance					4.5	m Ω
R_{thJC}	thermal resistance junction to case					0.7	K/W
R_{thCH}	thermal resistance case to heatsink				0.3		K/W
P_{tot}	total power dissipation			$T_C = 25^\circ\text{C}$		175	W
I_{FSM}	max. forward surge current	$t = 10$ ms; (50 Hz), sine	$T_{VJ} = 45^\circ\text{C}$			1.20	kA
		$t = 8,3$ ms; (60 Hz), sine	$V_R = 0$ V			1.30	kA
		$t = 10$ ms; (50 Hz), sine	$T_{VJ} = 150^\circ\text{C}$			1.02	kA
		$t = 8,3$ ms; (60 Hz), sine	$V_R = 0$ V			1.10	kA
I^2t	value for fusing	$t = 10$ ms; (50 Hz), sine	$T_{VJ} = 45^\circ\text{C}$			7.20	kA ² s
		$t = 8,3$ ms; (60 Hz), sine	$V_R = 0$ V			6.98	kA ² s
		$t = 10$ ms; (50 Hz), sine	$T_{VJ} = 150^\circ\text{C}$			5.20	kA ² s
		$t = 8,3$ ms; (60 Hz), sine	$V_R = 0$ V			5.04	kA ² s
C_J	junction capacitance	$V_R = 400$ V; $f = 1$ MHz	$T_{VJ} = 25^\circ\text{C}$		37		pF

PHASE OUT

Phase out

Package PWS-E				Ratings			
Symbol	Definition	Conditions	min.	typ.	max.	Unit	
I_{RMS}	RMS current	per terminal			200	A	
T_{VJ}	virtual junction temperature		-40		150	°C	
T_{op}	operation temperature		-40		125	°C	
T_{stg}	storage temperature		-40		125	°C	
Weight					284	g	
M_D	mounting torque		4.25		5.75	Nm	
M_T	terminal torque		4.25		5.75	Nm	
$d_{Spp/App}$	creepage distance on surface striking distance through air	terminal to terminal	12.0			mm	
$d_{Spb/Apb}$		terminal to backside	26.0			mm	
V_{ISOL}	isolation voltage	t = 1 second	3000			V	
		t = 1 minute	2500			V	
		50/60 Hz, RMS; $I_{ISOL} \leq 1$ mA					

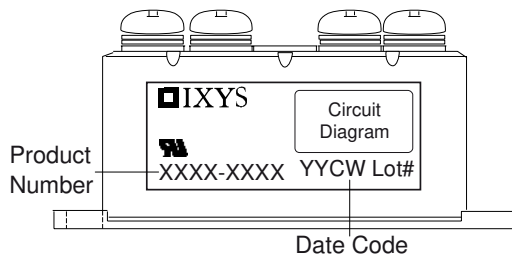

Ordering	Ordering Number	Marking on Product	Delivery Mode	Quantity	Code No.
Standard	VUO110-14NO7	VUO110-14NO7	Box	5	462381

Equivalent Circuits for Simulation

* on die level

$T_{VJ} = 150$ °C

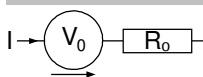

Rectifier

$V_{0 \max}$	threshold voltage	0.79	V
$R_{0 \max}$	slope resistance *	3.3	mΩ

Outlines PWS-E

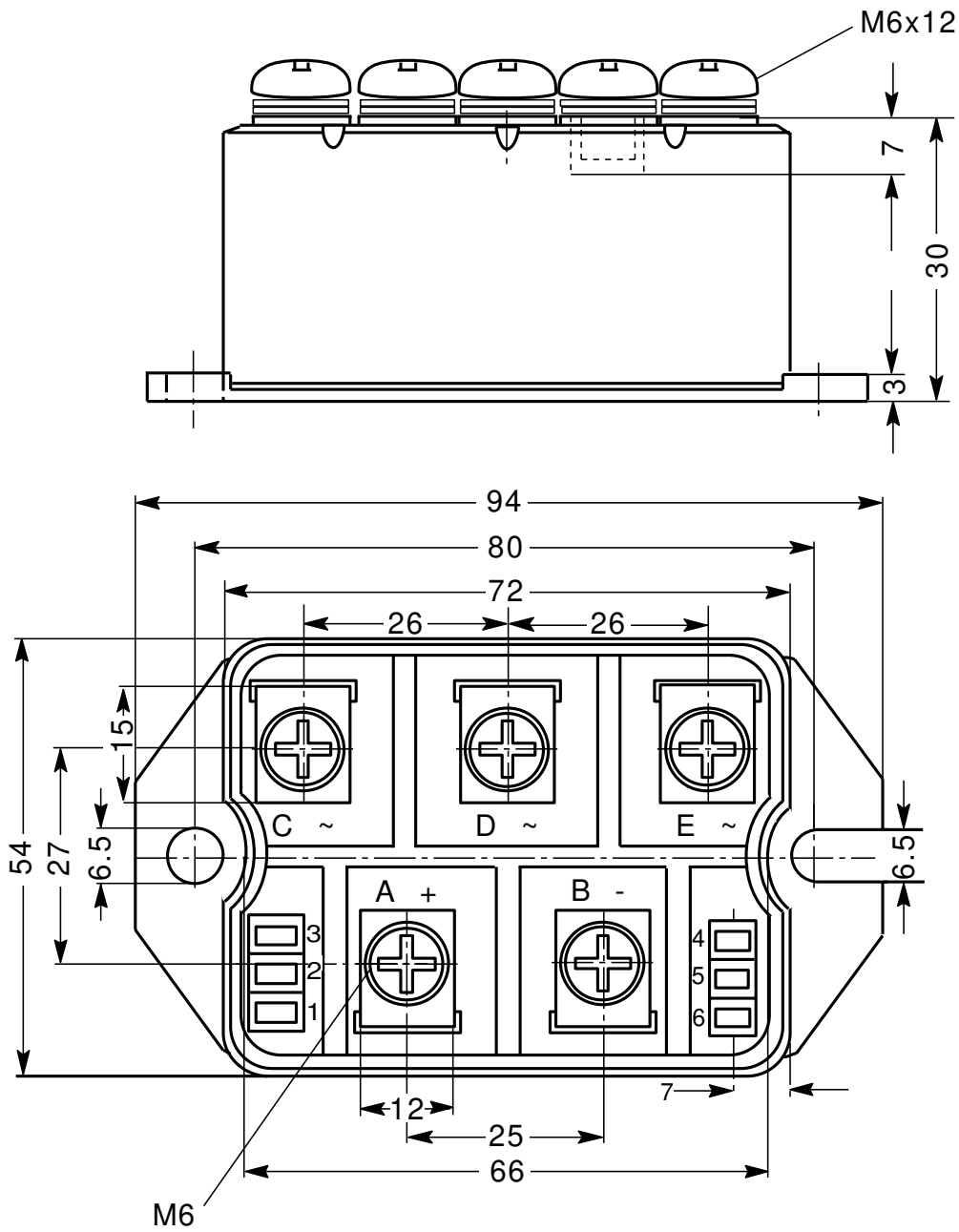

Rectifier

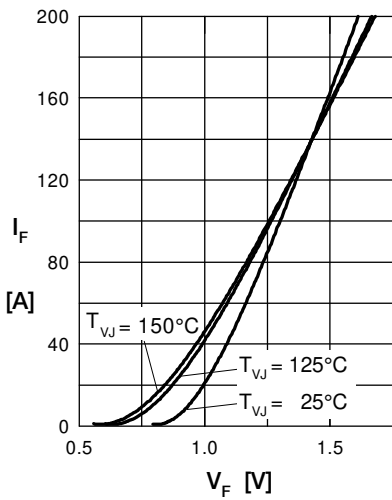

Fig. 1 Forward current vs. voltage drop per diode

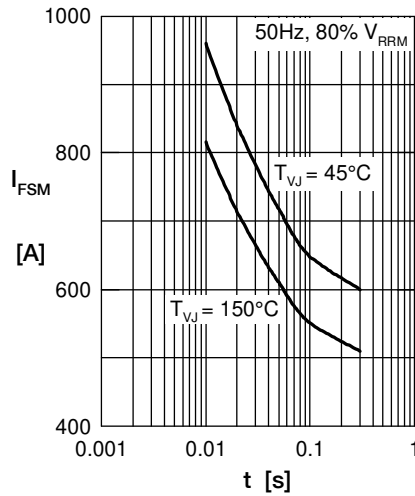

Fig. 2 Surge overload current vs. time per diode

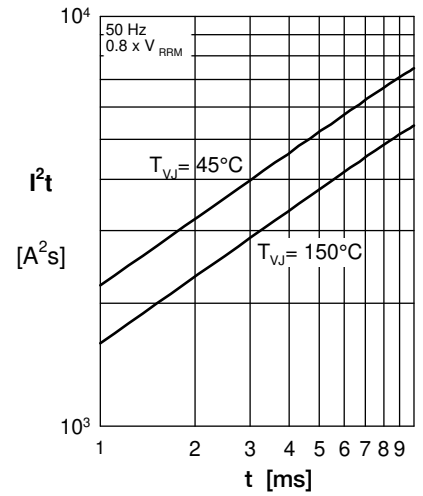

Fig. 3 I^2t vs. time per diode

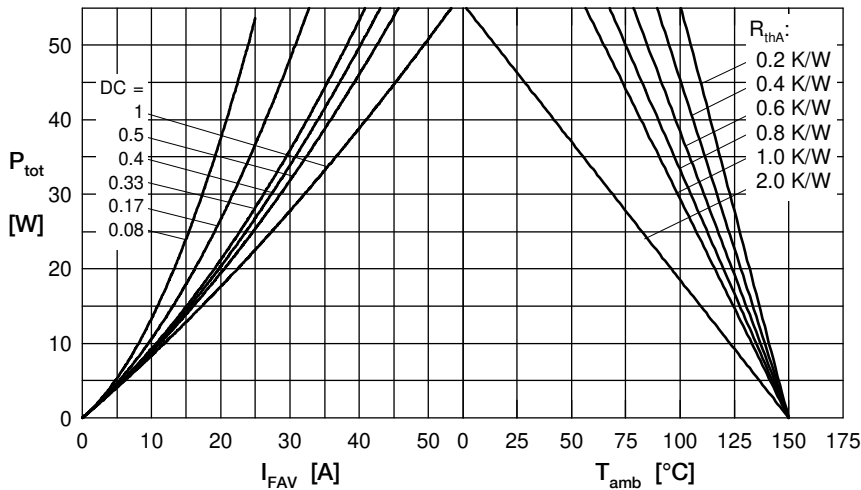

Fig. 4 Power dissipation vs. forward current and ambient temperature per diode

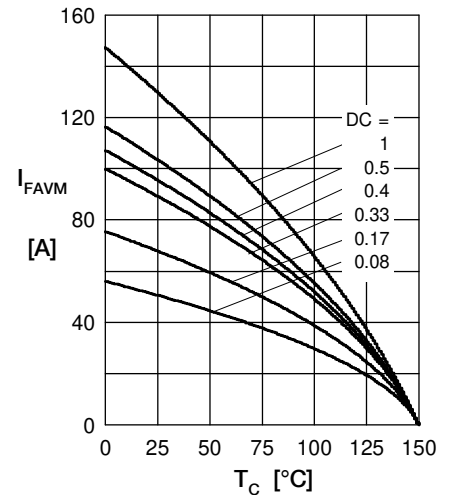

Fig. 5 Max. forward current vs. case temperature per diode

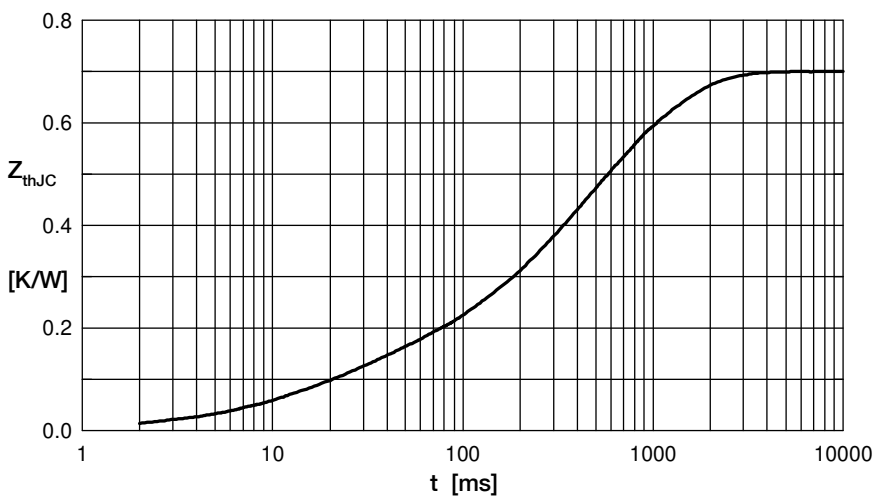

Fig. 6 Transient thermal impedance junction to case vs. time per diode

R_i	t_i
0.100	0.020
0.010	0.010
0.162	0.225
0.258	0.800
0.170	0.580

X-ON Electronics

Largest Supplier of Electrical and Electronic Components

Click to view similar products for [Bridge Rectifiers](#) category:

Click to view products by [IXYS](#) manufacturer:

Other Similar products are found below :

[MB2510](#) [MB252](#) [MB356G](#) [MB358G](#) [GBJ1504-BP](#) [GBU15J-BP](#) [GBU15K-BP](#) [GBU4A-BP](#) [GBU6B-E3/45](#) [GSIB680-E3/45](#) [DB101-BP](#)
[DF01](#) [DF10SA-E345](#) [KBPC50-10S](#) [RS405GL-BP](#) [G5SBA60-E3/51](#) [GBU10J-BP](#) [GBU6M](#) [GBU8D-BP](#) [GBU8J-BP](#) [GSIB1520-E3/45](#)
[2KBB10](#) [36MB140A](#) [TB102M](#) [MB1510](#) [MB258](#) [MB6M-G](#) [MB86](#) [TL401G](#) [MDA920A2](#) [TU602](#) [TU810](#) [MP501W-BP](#) [MP502-BP](#)
[BR101-BP](#) [BR84DTP204](#) [BU2008-E3/51](#) [36MB100A](#) [KBPC10/15/2501WP](#) [KBPC25-02](#) [VS-2KBB60](#) [DF06SA-E345](#) [DF1510S](#) [VS-](#)
[40MT160PAPBF](#) [W02M](#) [GBL02-E3/45](#) [GBU4G-BP](#) [GBJ2506-BP](#) [GBU6B-E3/51](#) [GSIB15A80-E3/45](#)