

Standard Rectifier Module

| |
|---------------------------|
| 3~ Rectifier |
| $V_{RRM} = 1600\text{ V}$ |
| $I_{DAV} = 125\text{ A}$ |
| $I_{FSM} = 1200\text{ A}$ |

3~ Rectifier Bridge

Part number

VUO110-16NO7



 E72873



Features / Advantages:

- Package with DCB ceramic
- Improved temperature and power cycling
- Planar passivated chips
- Very low forward voltage drop
- Very low leakage current

Applications:

- Diode for main rectification
- For three phase bridge configurations
- Supplies for DC power equipment
- Input rectifiers for PWM inverter
- Battery DC power supplies
- Field supply for DC motors

Package: PWS-E

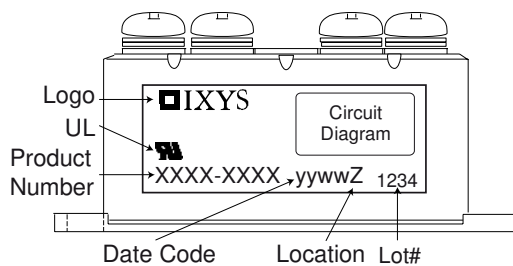
- Isolation Voltage: 3000 V~
- Industry standard outline
- RoHS compliant
- Easy to mount with two screws
- Base plate: Copper internally DCB isolated
- Advanced power cycling

Disclaimer Notice

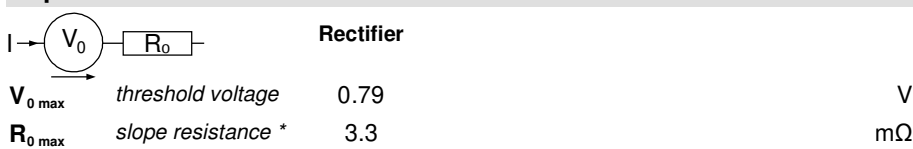
Information furnished is believed to be accurate and reliable. However, users should independently evaluate the suitability of and test each product selected for their own applications. Littelfuse products are not designed for, and may not be used in, all applications. Read complete Disclaimer Notice at www.littelfuse.com/disclaimer-electronics.

| Rectifier | | | | Ratings | | | |
|------------|--|-----------------------------|-------------------|------------------------------|------|------|-------------------|
| Symbol | Definition | Conditions | | min. | typ. | max. | Unit |
| V_{RSM} | max. non-repetitive reverse blocking voltage | | | | | 1700 | V |
| V_{RRM} | max. repetitive reverse blocking voltage | | | | | 1600 | V |
| I_R | reverse current | $V_R = 1600$ V | | $T_{VJ} = 25^\circ\text{C}$ | | 100 | μA |
| | | $V_R = 1600$ V | | $T_{VJ} = 150^\circ\text{C}$ | | 2 | mA |
| V_F | forward voltage drop | $I_F = 50$ A | | $T_{VJ} = 25^\circ\text{C}$ | | 1.13 | V |
| | | $I_F = 150$ A | | | | 1.46 | V |
| | | $I_F = 50$ A | | $T_{VJ} = 125^\circ\text{C}$ | | 1.04 | V |
| | | $I_F = 150$ A | | | | 1.47 | V |
| I_{DAV} | bridge output current | $T_C = 110^\circ\text{C}$ | | $T_{VJ} = 150^\circ\text{C}$ | | 125 | A |
| | | rectangular | $d = \frac{1}{3}$ | | | | |
| V_{FO} | threshold voltage | | | $T_{VJ} = 150^\circ\text{C}$ | | 0.79 | V |
| r_F | slope resistance | | | | | 4.5 | m Ω |
| R_{thJC} | thermal resistance junction to case | | | | | 0.7 | K/W |
| R_{thCH} | thermal resistance case to heatsink | | | | 0.3 | | K/W |
| P_{tot} | total power dissipation | | | $T_C = 25^\circ\text{C}$ | | 175 | W |
| I_{FSM} | max. forward surge current | $t = 10$ ms; (50 Hz), sine | | $T_{VJ} = 45^\circ\text{C}$ | | 1.20 | kA |
| | | $t = 8,3$ ms; (60 Hz), sine | | $V_R = 0$ V | | 1.30 | kA |
| | | $t = 10$ ms; (50 Hz), sine | | $T_{VJ} = 150^\circ\text{C}$ | | 1.02 | kA |
| | | $t = 8,3$ ms; (60 Hz), sine | | $V_R = 0$ V | | 1.10 | kA |
| I^2t | value for fusing | $t = 10$ ms; (50 Hz), sine | | $T_{VJ} = 45^\circ\text{C}$ | | 7.20 | kA ² s |
| | | $t = 8,3$ ms; (60 Hz), sine | | $V_R = 0$ V | | 6.98 | kA ² s |
| | | $t = 10$ ms; (50 Hz), sine | | $T_{VJ} = 150^\circ\text{C}$ | | 5.20 | kA ² s |
| | | $t = 8,3$ ms; (60 Hz), sine | | $V_R = 0$ V | | 5.04 | kA ² s |
| C_J | junction capacitance | $V_R = 400$ V; $f = 1$ MHz | | $T_{VJ} = 25^\circ\text{C}$ | | 37 | pF |

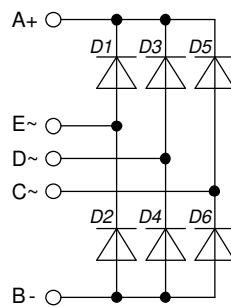
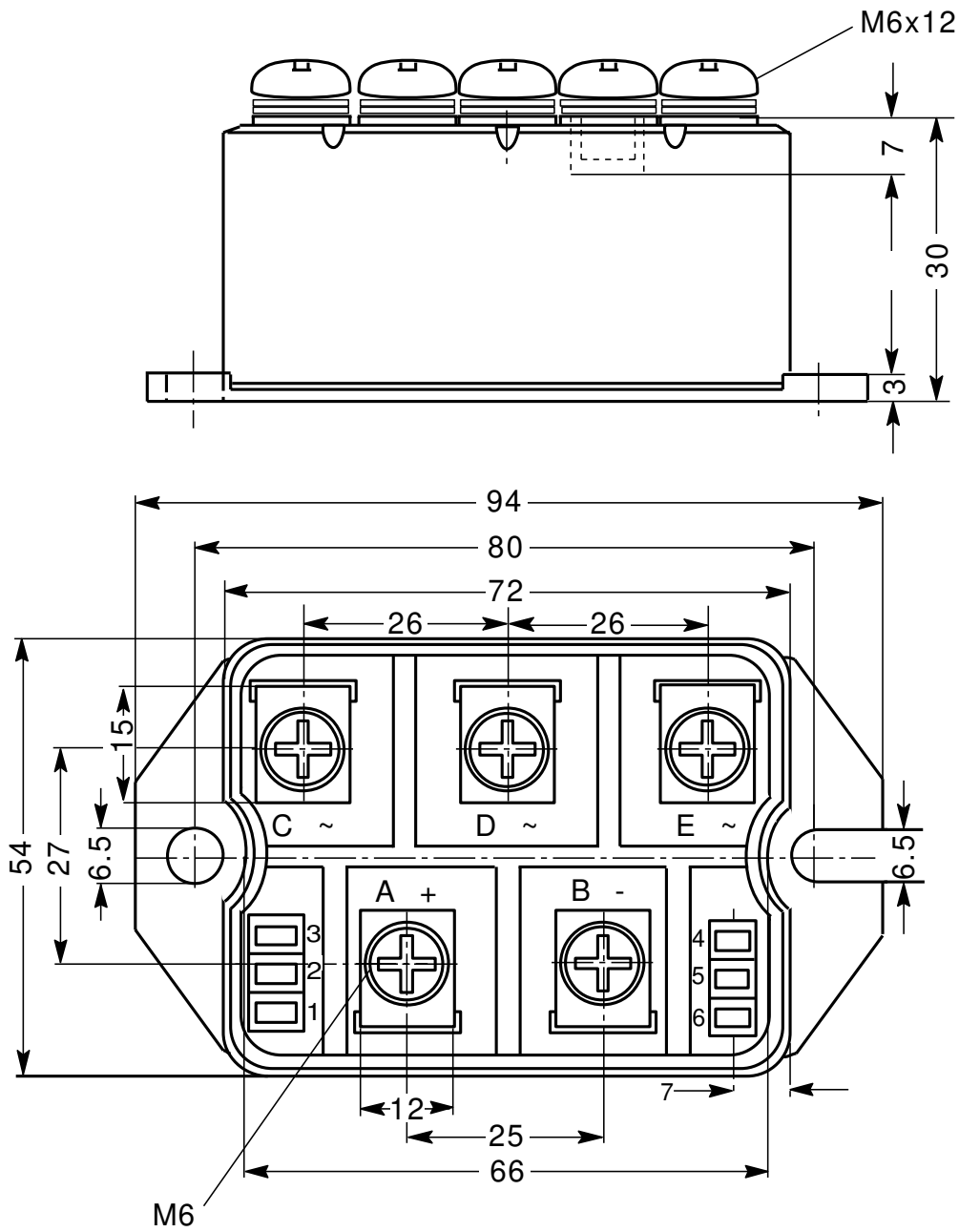
| Package PWS-E | | | | Ratings | | | |
|---------------|--|----------------------|------|---------|------|------|--|
| Symbol | Definition | Conditions | min. | typ. | max. | Unit | |
| I_{RMS} | RMS current | per terminal | | | 200 | A | |
| T_{VJ} | virtual junction temperature | | -40 | | 150 | °C | |
| T_{op} | operation temperature | | -40 | | 125 | °C | |
| T_{stg} | storage temperature | | -40 | | 125 | °C | |
| Weight | | | | | 284 | g | |
| M_D | mounting torque | | 4.25 | | 5.75 | Nm | |
| M_T | terminal torque | | 4.25 | | 5.75 | Nm | |
| $d_{Spp/App}$ | creepage distance on surface striking distance through air | terminal to terminal | 12.0 | | | mm | |
| $d_{Spb/Apb}$ | | terminal to backside | 26.0 | | | mm | |
| V_{ISOL} | isolation voltage | t = 1 second | 3000 | | | V | |
| | | t = 1 minute | 2500 | | | V | |



| Ordering | Ordering Number | Marking on Product | Delivery Mode | Quantity | Code No. |
|----------|-----------------|--------------------|---------------|----------|----------|
| Standard | VUO110-16NO7 | VUO110-16NO7 | Box | 5 | 462403 |

Equivalent Circuits for Simulation
** on die level*
 $T_{VJ} = 150^{\circ}\text{C}$


Outlines PWS-E



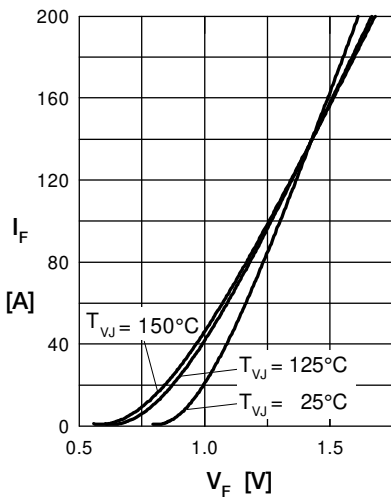
Rectifier


Fig. 1 Forward current vs. voltage drop per diode

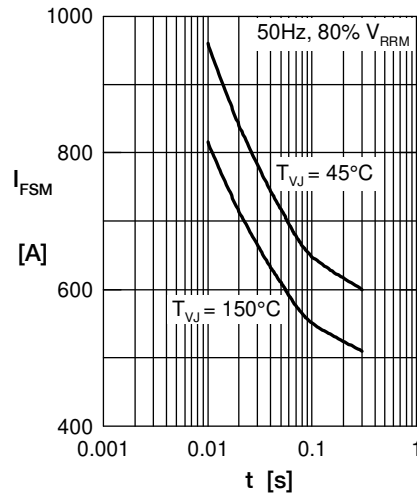


Fig. 2 Surge overload current vs. time per diode

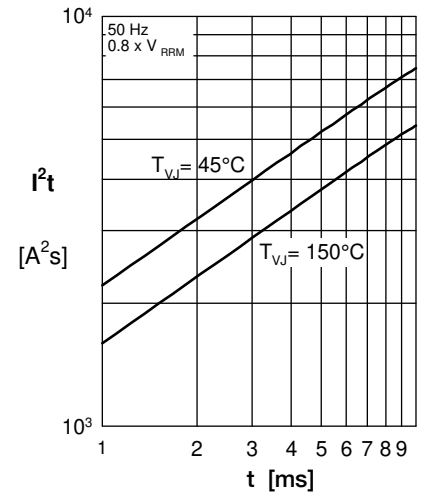
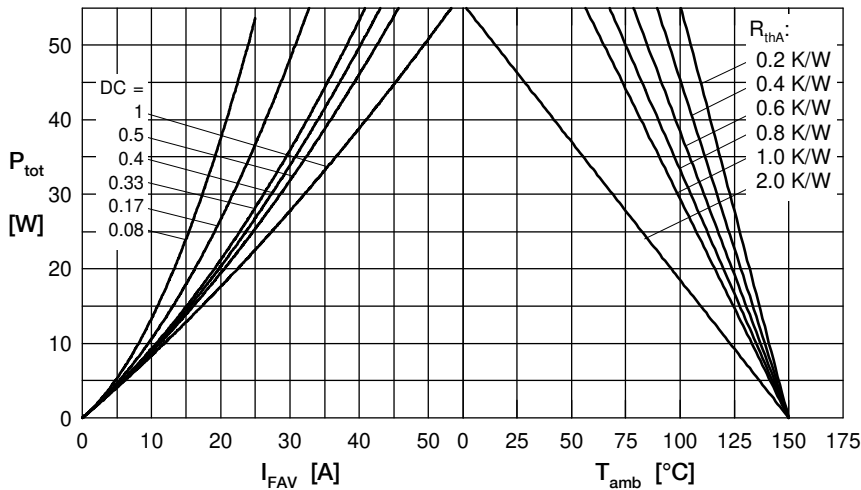

 Fig. 3 I^2t vs. time per diode


Fig. 4 Power dissipation vs. forward current and ambient temperature per diode

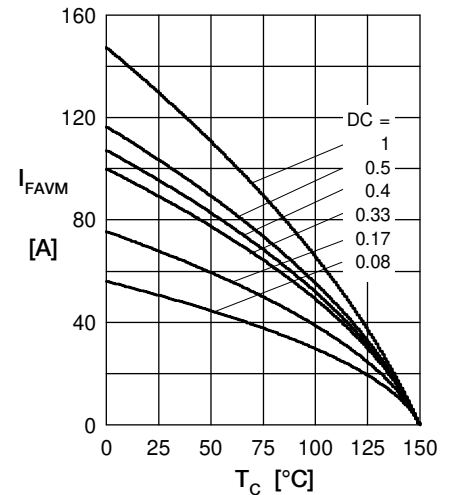


Fig. 5 Max. forward current vs. case temperature per diode

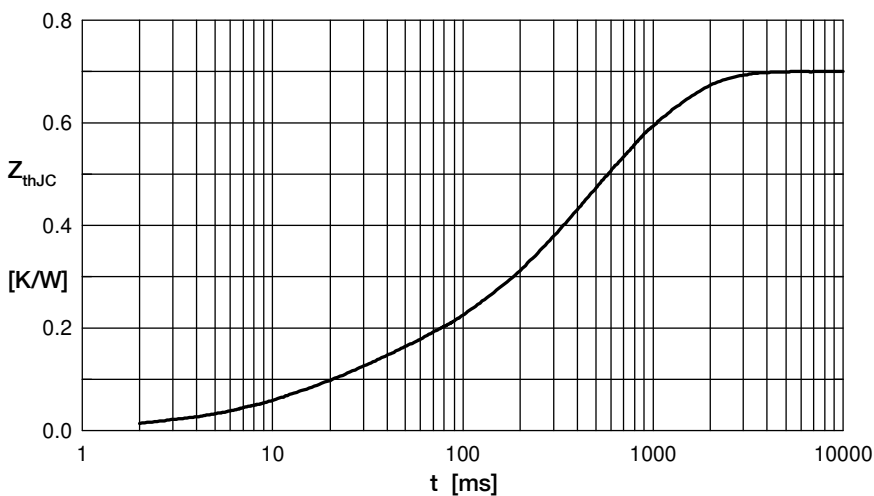


Fig. 6 Transient thermal impedance junction to case vs. time per diode

| R_i | t_i |
|-------|-------|
| 0.100 | 0.020 |
| 0.010 | 0.010 |
| 0.162 | 0.225 |
| 0.258 | 0.800 |
| 0.170 | 0.580 |

X-ON Electronics

Largest Supplier of Electrical and Electronic Components

Click to view similar products for [Bridge Rectifiers](#) category:

Click to view products by [IXYS](#) manufacturer:

Other Similar products are found below :

[MB2510](#) [MB252](#) [MB356G](#) [MB358G](#) [GBJ1504-BP](#) [GBU15J-BP](#) [GBU15K-BP](#) [GBU4A-BP](#) [GBU6B-E3/45](#) [GSIB680-E3/45](#) [DB101-BP](#)
[DF01](#) [DF10SA-E345](#) [BU1508-E3/45](#) [KBPC50-10S](#) [RS405GL-BP](#) [G5SBA60-E3/51](#) [GBU10J-BP](#) [GBU6M](#) [GBU8D-BP](#) [GBU8J-BP](#)
[2KBB10](#) [36MB140A](#) [TB102M](#) [MB1510](#) [MB258](#) [MB6M-G](#) [MB86](#) [TL401G](#) [MDA920A2](#) [TU602](#) [TU810](#) [MP501W-BP](#) [MP502-BP](#)
[BR101-BP](#) [BR84DTP204](#) [BU2008-E3/51](#) [KBPC10/15/2501WP](#) [KBPC25-02](#) [VS-2KBB60](#) [DF06SA-E345](#) [DF1510S](#) [VS-40MT160PAPBF](#)
[W02M](#) [GBL02-E3/45](#) [GBU4G-BP](#) [GBJ2506-BP](#) [GBU6B-E3/51](#) [GSIB15A80-E3/45](#) [DB104-BP](#)