

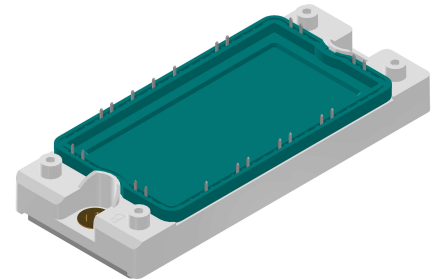
Thyristor Module

3~ Rectifier	Brake Chopper
$V_{RRM} = 1600 \text{ V}$	$V_{CES} = 1200 \text{ V}$
$I_{DAV} = 150 \text{ A}$	$I_{C25} = 120 \text{ A}$
$I_{FSM} = 700 \text{ A}$	$V_{CE(sat)} = 1.8 \text{ V}$

3~ Rectifier Bridge, half-controlled (high-side) + Brake Unit + NTC

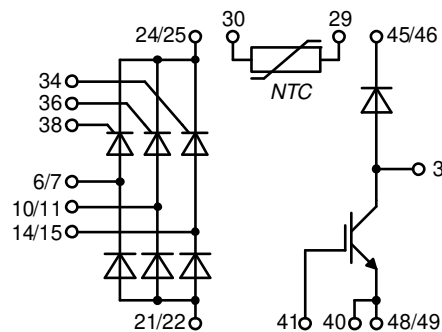
Part number

VVZB135-16ioXT



Backside: isolated

 E72873



Features / Advantages:

- Package with DCB ceramic
- Improved temperature and power cycling
- Planar passivated chips
- Very low forward voltage drop
- Very low leakage current
- NTC

Applications:

- 3~ Rectifier with brake unit for drive inverters

Package: E2-Pack

- Isolation Voltage: 3600 V~
- Industry standard outline
- RoHS compliant
- Soldering pins for PCB mounting
- Height: 17 mm
- Base plate: DCB ceramic
- Reduced weight
- Advanced power cycling

Disclaimer Notice

Information furnished is believed to be accurate and reliable. However, users should independently evaluate the suitability of and test each product selected for their own applications. Littelfuse products are not designed for, and may not be used in, all applications. Read complete Disclaimer Notice at www.littelfuse.com/disclaimer-electronics.

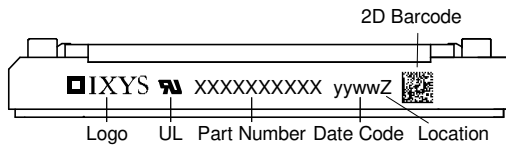
Rectifier				Ratings			
Symbol	Definition	Conditions	min.	typ.	max.	Unit	
$V_{RSM/DSM}$	max. non-repetitive reverse/forward blocking voltage	$T_{VJ} = 25^{\circ}C$			1700	V	
$V_{RRM/DRM}$	max. repetitive reverse/forward blocking voltage	$T_{VJ} = 25^{\circ}C$			1600	V	
I_{RD}	reverse current, drain current	$V_{R/D} = 1600 V$	$T_{VJ} = 25^{\circ}C$		100	μA	
		$V_{R/D} = 1600 V$	$T_{VJ} = 150^{\circ}C$		20	mA	
V_T	forward voltage drop	$I_T = 50 A$	$T_{VJ} = 25^{\circ}C$		1.32	V	
		$I_T = 150 A$			1.92	V	
		$I_T = 50 A$	$T_{VJ} = 125^{\circ}C$		1.26	V	
		$I_T = 150 A$			1.96	V	
I_{DAV}	bridge output current	$T_C = 85^{\circ}C$ rectangular $d = 1/3$	$T_{VJ} = 150^{\circ}C$		150	A	
V_{T0}	threshold voltage	} for power loss calculation only	$T_{VJ} = 150^{\circ}C$		0.88	V	
r_T	slope resistance				7.3	m Ω	
R_{thJC}	thermal resistance junction to case				0.65	K/W	
R_{thCH}	thermal resistance case to heatsink			0.1		K/W	
P_{tot}	total power dissipation		$T_C = 25^{\circ}C$		190	W	
I_{TSM}	max. forward surge current	$t = 10 ms; (50 Hz), sine$	$T_{VJ} = 45^{\circ}C$		700	A	
		$t = 8,3 ms; (60 Hz), sine$	$V_R = 0 V$		755	A	
		$t = 10 ms; (50 Hz), sine$	$T_{VJ} = 150^{\circ}C$		595	A	
		$t = 8,3 ms; (60 Hz), sine$	$V_R = 0 V$		645	A	
I^2t	value for fusing	$t = 10 ms; (50 Hz), sine$	$T_{VJ} = 45^{\circ}C$		2.45	kA ² s	
		$t = 8,3 ms; (60 Hz), sine$	$V_R = 0 V$		2.37	kA ² s	
		$t = 10 ms; (50 Hz), sine$	$T_{VJ} = 150^{\circ}C$		1.77	kA ² s	
		$t = 8,3 ms; (60 Hz), sine$	$V_R = 0 V$		1.73	kA ² s	
C_J	junction capacitance	$V_R = 400 V f = 1 MHz$	$T_{VJ} = 25^{\circ}C$		32	pF	
P_{GM}	max. gate power dissipation	$t_p = 30 \mu s$	$T_C = 150^{\circ}C$		10	W	
		$t_p = 300 \mu s$			5	W	
P_{GAV}	average gate power dissipation				0.5	W	
$(di/dt)_{cr}$	critical rate of rise of current	$T_{VJ} = 150^{\circ}C; f = 50 Hz$ repetitive, $I_T = 150 A$			150	A/ μs	
		$t_p = 200 \mu s; di_G/dt = 0.45 A/\mu s;$ $I_G = 0.45 A; V = 2/3 V_{DRM}$ non-repet., $I_T = 50 A$			500	A/ μs	
$(dv/dt)_{cr}$	critical rate of rise of voltage	$V = 2/3 V_{DRM}$ $R_{GK} = \infty; method 1 (linear voltage rise)$	$T_{VJ} = 150^{\circ}C$		1000	V/ μs	
V_{GT}	gate trigger voltage	$V_D = 6 V$	$T_{VJ} = 25^{\circ}C$		1.4	V	
			$T_{VJ} = -40^{\circ}C$		1.6	V	
I_{GT}	gate trigger current	$V_D = 6 V$	$T_{VJ} = 25^{\circ}C$		80	mA	
			$T_{VJ} = -40^{\circ}C$		200	mA	
V_{GD}	gate non-trigger voltage	$V_D = 2/3 V_{DRM}$	$T_{VJ} = 150^{\circ}C$		0.2	V	
I_{GD}	gate non-trigger current				5	mA	
I_L	latching current	$t_p = 10 \mu s$	$T_{VJ} = 25^{\circ}C$		450	mA	
		$I_G = 0.45 A; di_G/dt = 0.45 A/\mu s$					
I_H	holding current	$V_D = 6 V R_{GK} = \infty$	$T_{VJ} = 25^{\circ}C$		100	mA	
t_{gd}	gate controlled delay time	$V_D = 1/2 V_{DRM}$ $I_G = 0.45 A; di_G/dt = 0.45 A/\mu s$	$T_{VJ} = 25^{\circ}C$		2	μs	
t_q	turn-off time	$V_R = 100 V; I_T = 50 A; V = 2/3 V_{DRM}$ $di/dt = 10 A/\mu s dv/dt = 20 V/\mu s t_p = 200 \mu s$	$T_{VJ} = 125^{\circ}C$	150		μs	



Brake IGBT				Ratings			
Symbol	Definition	Conditions	min.	typ.	max.	Unit	
V_{CES}	collector emitter voltage	$T_{VJ} = 25^{\circ}C$			1200	V	
V_{GES}	max. DC gate voltage				± 20	V	
V_{GEM}	max. transient gate emitter voltage				± 30	V	
I_{C25}	collector current	$T_C = 25^{\circ}C$			120	A	
I_{C80}		$T_C = 80^{\circ}C$			84	A	
P_{tot}	total power dissipation	$T_C = 25^{\circ}C$			390	W	
$V_{CE(sat)}$	collector emitter saturation voltage	$I_C = 75\text{ A}; V_{GE} = 15\text{ V}$			1.8	V	
					2.1	V	
$V_{GE(th)}$	gate emitter threshold voltage	$I_C = 3\text{ mA}; V_{GE} = V_{CE}$	5.5	6.0	6.5	V	
I_{CES}	collector emitter leakage current	$V_{CE} = V_{CES}; V_{GE} = 0\text{ V}$			0.2	mA	
					0.6	mA	
I_{GES}	gate emitter leakage current	$V_{GE} = \pm 20\text{ V}$			500	nA	
$Q_{G(on)}$	total gate charge	$V_{CE} = 600\text{ V}; V_{GE} = 15\text{ V}; I_C = 75\text{ A}$		230		nC	
$t_{d(on)}$	turn-on delay time	inductive load $V_{CE} = 600\text{ V}; I_C = 75\text{ A}$ $V_{GE} = \pm 15\text{ V}; R_G = 10\ \Omega$	$T_{VJ} = 125^{\circ}C$		70	ns	
t_r	current rise time				40	ns	
$t_{d(off)}$	turn-off delay time				250	ns	
t_f	current fall time				100	ns	
E_{on}	turn-on energy per pulse				6.8	mJ	
E_{off}	turn-off energy per pulse				8.3	mJ	
RBSOA	reverse bias safe operating area	$V_{GE} = \pm 15\text{ V}; R_G = 10\ \Omega$					
I_{CM}		$V_{CEK} = 1200\text{ V}$			225	A	
SCSOA	short circuit safe operating area	$V_{CEK} = 1200\text{ V}$					
t_{SC}	short circuit duration	$V_{CE} = 900\text{ V}; V_{GE} = \pm 15$	$T_{VJ} = 125^{\circ}C$		10	μs	
I_{SC}	short circuit current	$R_G = 10\ \Omega$; non-repetitive		300		A	
R_{thJC}	thermal resistance junction to case				0.32	K/W	
R_{thCH}	thermal resistance case to heatsink				0.15	K/W	
Brake Diode							
V_{RRM}	max. repetitive reverse voltage		$T_{VJ} = 25^{\circ}C$		1200	V	
I_{F25}	forward current		$T_C = 25^{\circ}C$		48	A	
I_{F80}			$T_C = 80^{\circ}C$		32	A	
V_F	forward voltage	$I_F = 30\text{ A}$	$T_{VJ} = 25^{\circ}C$		2.75	V	
			$T_{VJ} = 125^{\circ}C$	1.99		V	
I_R	reverse current	$V_R = V_{RRM}$	$T_{VJ} = 25^{\circ}C$		0.25	mA	
			$T_{VJ} = 125^{\circ}C$		1	mA	
Q_{rr}	reverse recovery charge	$V_R = 600\text{ V}$ $-di_f/dt = 400\text{ A}/\mu s$ $I_F = 30\text{ A}; V_{GE} = 0\text{ V}$	$T_{VJ} = 125^{\circ}C$		1.8	μC	
I_{RM}	max. reverse recovery current				23	A	
t_{rr}	reverse recovery time				150	ns	
R_{thJC}	thermal resistance junction to case				0.9	K/W	
R_{thCH}	thermal resistance case to heatsink				0.3	K/W	



Package E2-Pack		Ratings				
Symbol	Definition	Conditions	min.	typ.	max.	Unit
I_{RMS}	RMS current	per terminal			50	A
T_{VJ}	virtual junction temperature		-40		150	°C
T_{op}	operation temperature		-40		125	°C
T_{stg}	storage temperature		-40		125	°C
Weight				176		g
M_D	mounting torque		3		6	Nm
$d_{Spp/App}$	creepage distance on surface / striking distance through air	terminal to terminal	6.0			mm
$d_{Spb/Apb}$		terminal to backside	12.0			mm
V_{ISOL}	isolation voltage	t = 1 second 50/60 Hz, RMS; $I_{ISOL} \leq 1$ mA	3600			V
		t = 1 minute	3000			V



Ordering	Ordering Number	Marking on Product	Delivery Mode	Quantity	Code No.
Standard	VVZB135-16IOXT	VVZB135-16IOXT	Box	6	510134

Temperature Sensor NTC

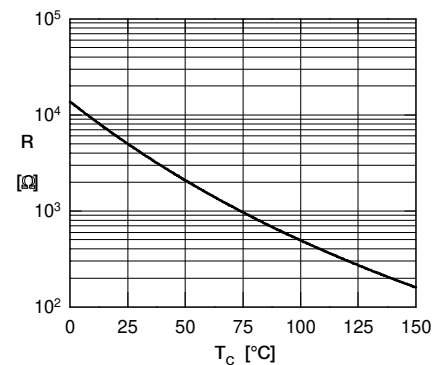
Symbol	Definition	Conditions	min.	typ.	max.	Unit
R_{25}	resistance	$T_{VJ} = 25^\circ$	4.75	5	5.25	k Ω
$B_{25/50}$	temperature coefficient			3375		K

Equivalent Circuits for Simulation

* on die level

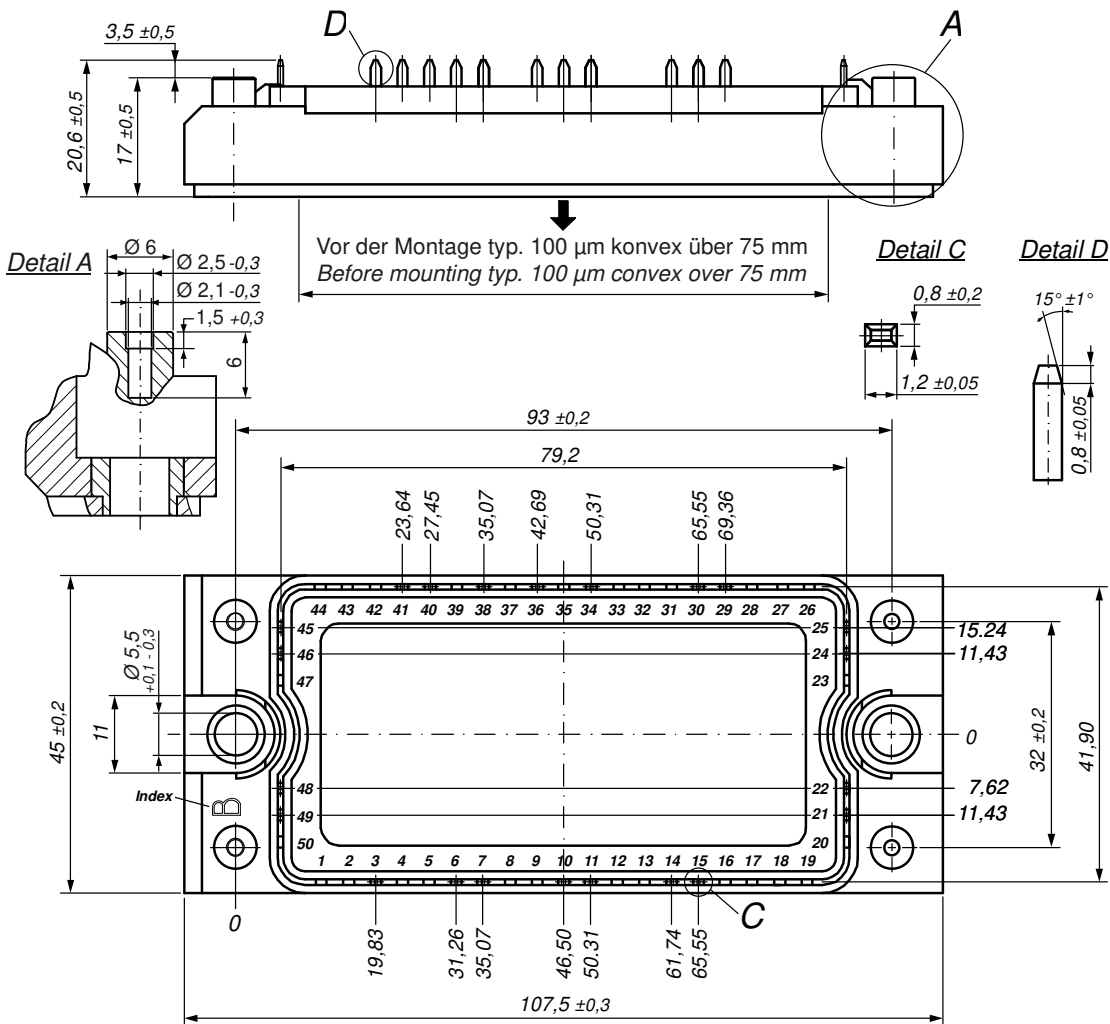
$T_{VJ} = 150^\circ\text{C}$

	Thyristor	Brake IGBT	Brake Diode	
V_0 max	0.88	1.1	1.31	V
R_0 max	4.1	17.9	8	m Ω





Outlines E2-Pack

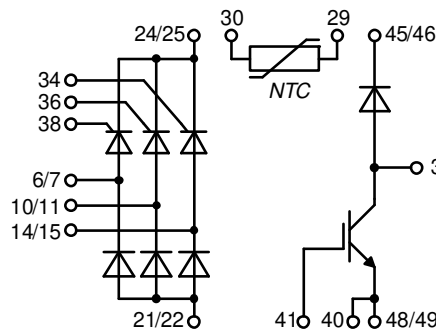


Bemerkung / Note:

- Nichttolerierete Maße nach / Measure without tolerances according DIN ISO 2768-T1-m
- PCB-Lochmuster / PCB hole pattern: **see pin position**
- Toleranz Pin-Position und PCB-Lochmuster / Tolerance of pin position and PCB hole pattern: $\oplus 0,1$
- Montageanleitung / Mounting instruction: www.ixys.com **Application note IXAN0024**

Detail A: PCB-Montage / Mounting on PCB ^L

- Empfohlene, selbstschneidende Schraube / Recommended, self-tapping screw: **EJOT PT®** (Größe / size: **K25**) ^L
- Max. Schraubenlänge / Max. screw length: **PCB-Dicke / thickness + 6 mm** (max. Lochtiefe / hole depth) ^L
- Empfohlenes Drehmoment / Recommended mounting torque: **1.5 Nm**



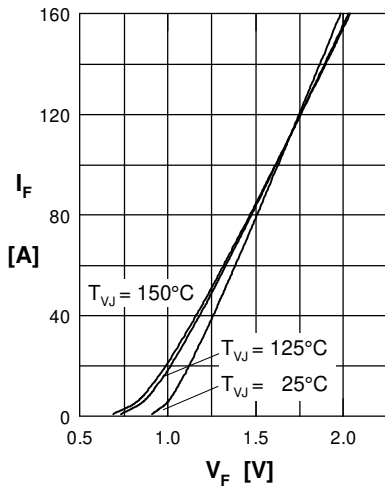
Thyristor


Fig. 1 Forward current vs. voltage drop per thyristor

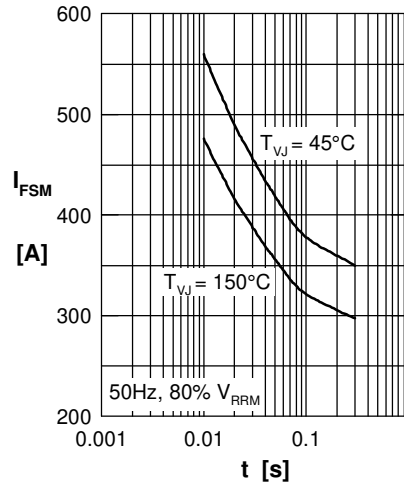


Fig. 2 Surge overload current vs. time per thyristor

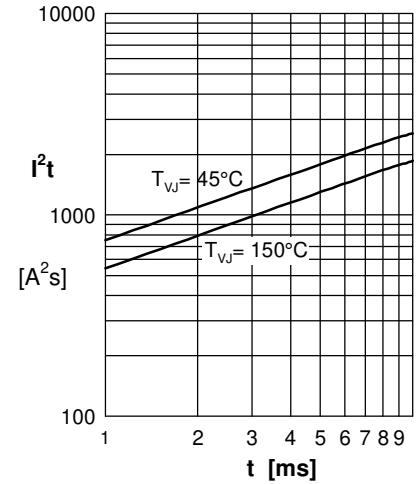
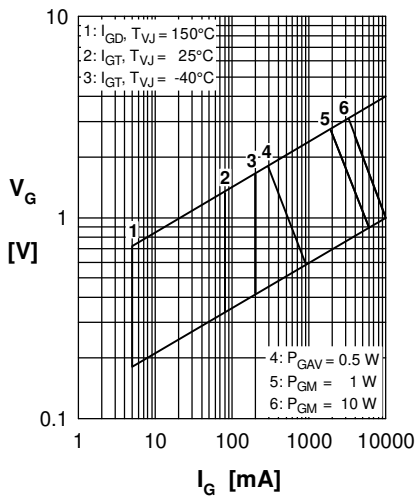

 Fig. 3 I^2t vs. time per thyristor


Fig. 4 Gate trigger characteristics

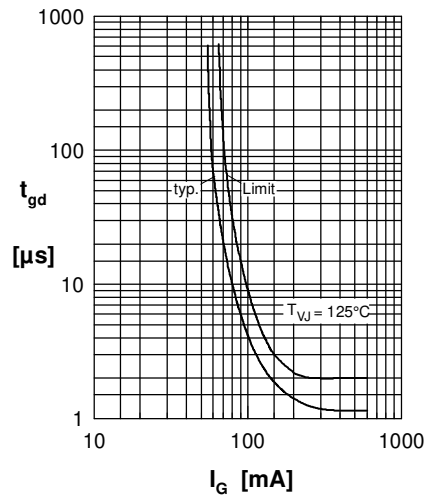


Fig. 5 Gate controlled delay time

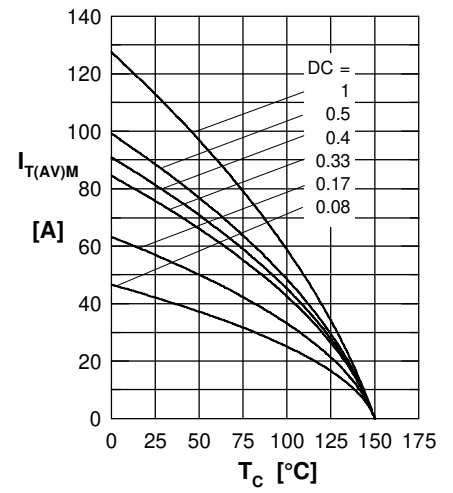


Fig. 5 Max. forward current vs. case temperature per thyristor

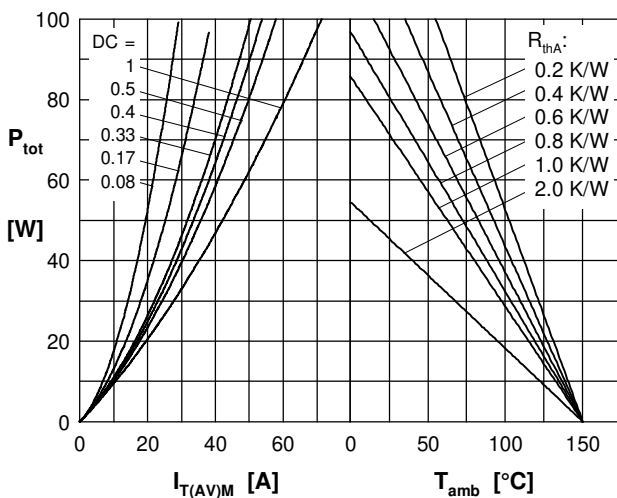


Fig. 4 Power dissipation vs. forward current and ambient temperature per thyristor

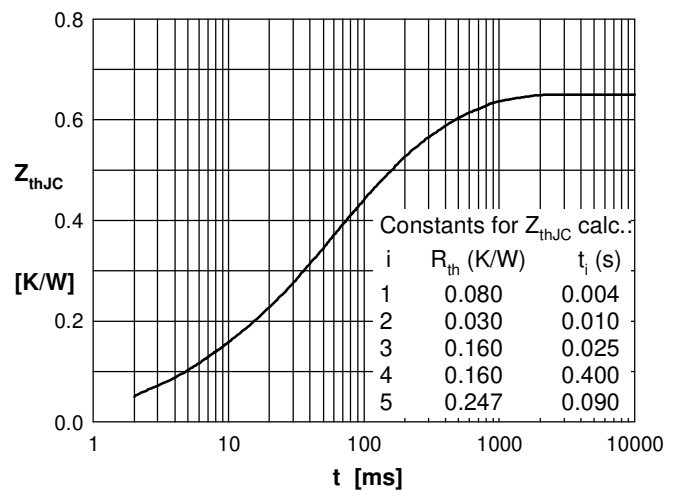


Fig. 6 Transient thermal impedance junction to case vs. time per thyristor

Brake IGBT

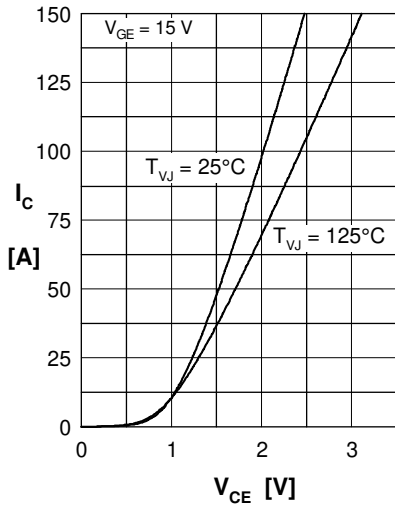


Fig. 1 Typ. output characteristics

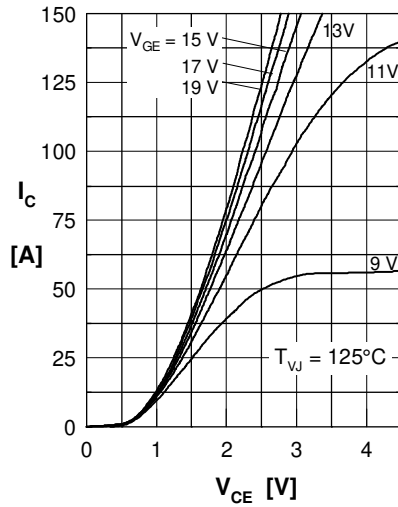


Fig. 2 Typ. output characteristics

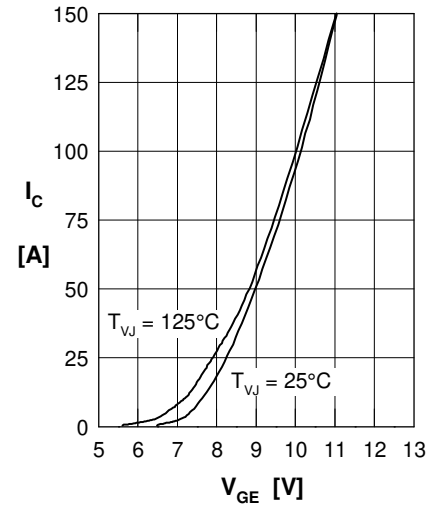


Fig. 3 Typ. transfer characteristics

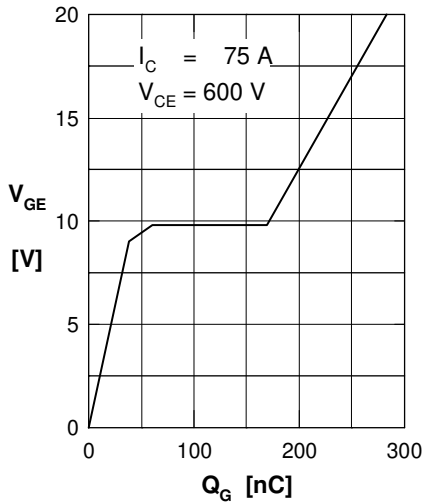


Fig. 4 Typ. turn-on gate charge

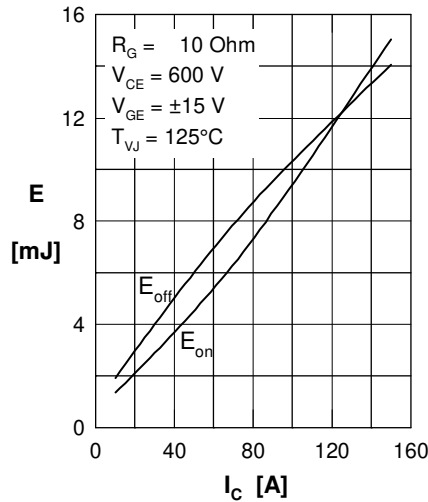


Fig. 5 Typ. switching energy versus collector current

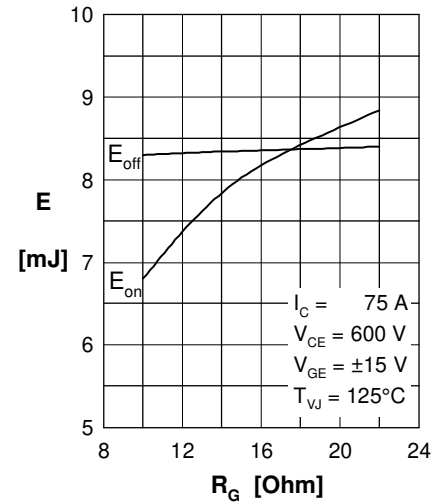


Fig. 6 Typ. switching energy versus gate resistance

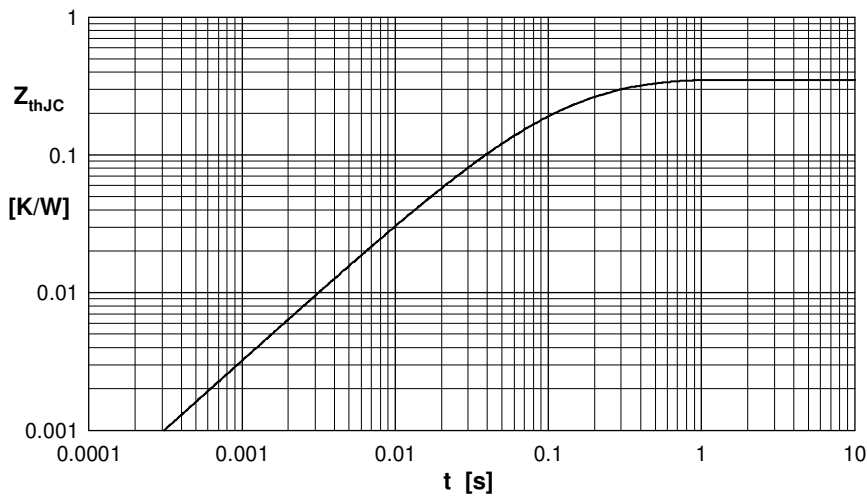


Fig. 7 Typ. transient thermal impedance junction to case

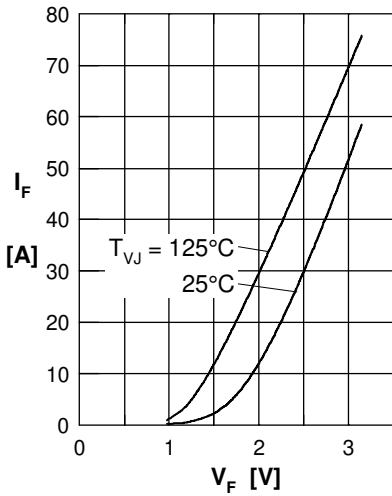
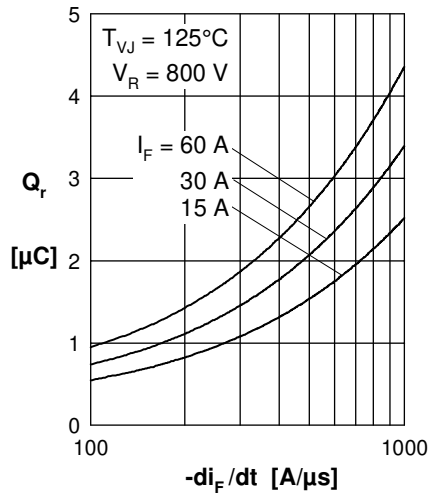
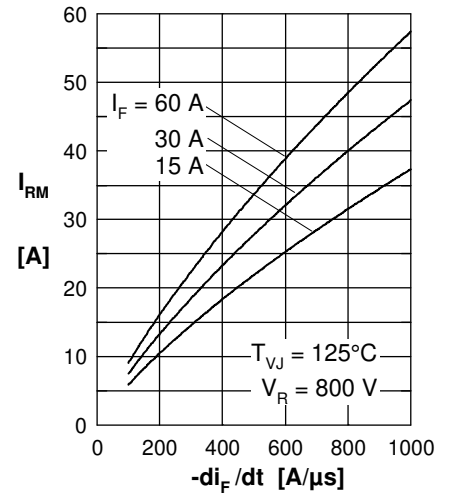
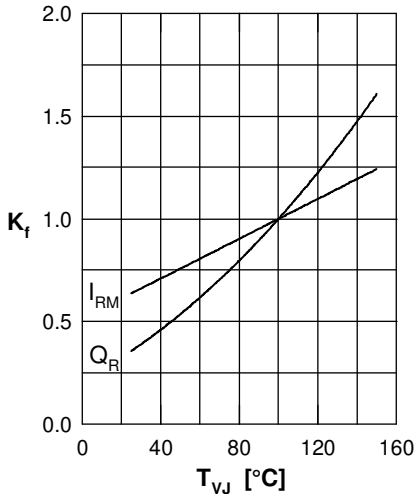
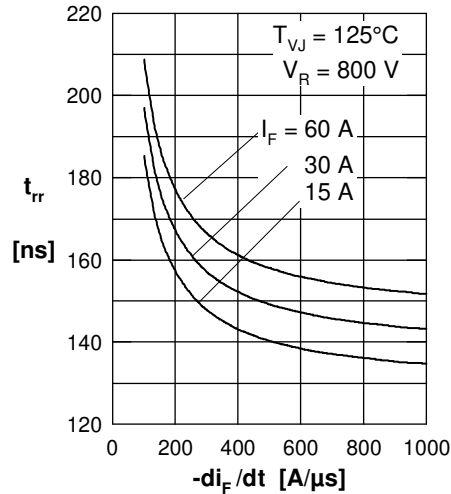
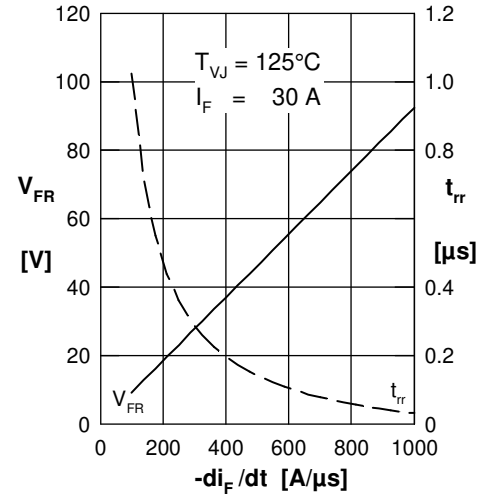
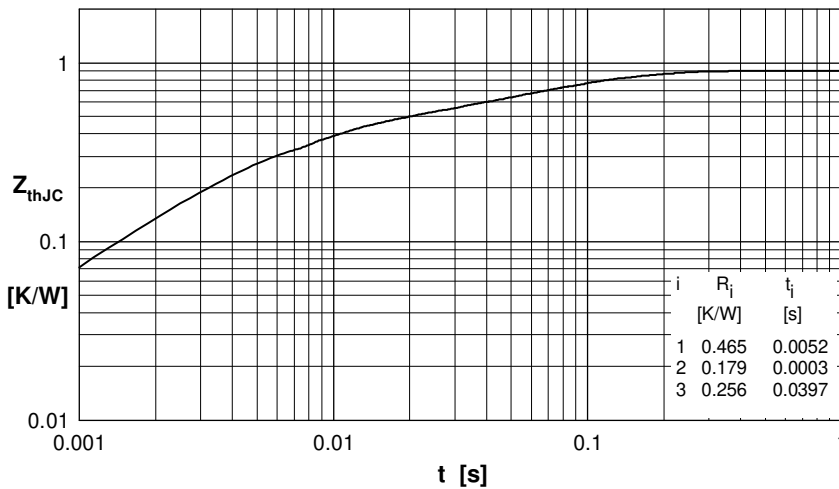
Brake Diode

 Fig. 1 Forward current I_F vs. V_F

 Fig. 2 Typ. reverse recovery charge Q_r versus $-di_F/dt$

 Fig. 3 Typ. peak reverse current I_{RM} versus $-di_F/dt$

 Fig. 4 Dynamic parameters Q_r , I_{RM} versus T_{VJ}

 Fig. 5 Typ. recovery time t_{rr} versus $-di_F/dt$

 Fig. 6 Typ. peak forward voltage V_{FR} and t_{rr} versus di_F/dt


Fig. 7 Transient thermal impedance junction to case

X-ON Electronics

Largest Supplier of Electrical and Electronic Components

Click to view similar products for [Bridge Rectifiers](#) category:

Click to view products by [IXYS](#) manufacturer:

Other Similar products are found below :

[MB2510](#) [MB252](#) [MB356G](#) [MB358G](#) [GBJ1504-BP](#) [GBU15J-BP](#) [GBU15K-BP](#) [GBU4A-BP](#) [GBU6B-E3/45](#) [GSIB680-E3/45](#) [DB101-BP](#)
[DF01](#) [DF10SA-E345](#) [BU1508-E3/45](#) [KBPC50-10S](#) [RS405GL-BP](#) [G5SBA60-E3/51](#) [GBU10J-BP](#) [GBU6M](#) [GBU8D-BP](#) [GBU8J-BP](#)
[2KBB10](#) [36MB140A](#) [TB102M](#) [MB1510](#) [MB258](#) [MB6M-G](#) [MB86](#) [TL401G](#) [MDA920A2](#) [TU602](#) [TU810](#) [MP501W-BP](#) [MP502-BP](#)
[BR101-BP](#) [BR84DTP204](#) [BU2008-E3/51](#) [KBPC10/15/2501WP](#) [KBPC25-02](#) [VS-2KBB60](#) [DF06SA-E345](#) [DF1510S](#) [VS-40MT160PAPBF](#)
[W02M](#) [GBL02-E3/45](#) [GBU4G-BP](#) [GBJ2506-BP](#) [GBU6B-E3/51](#) [GSIB15A80-E3/45](#) [DB104-BP](#)