

**DOUBLE DENSITY TYPE · D02 SERIES**

**D02 SERIES**

**D02 STANDARD SHELL**

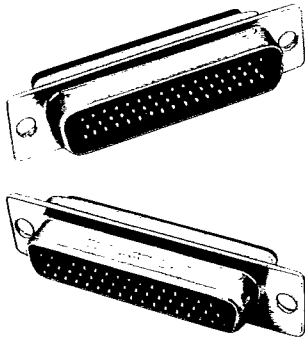

(The pictures here show connectors with contacts loaded.)

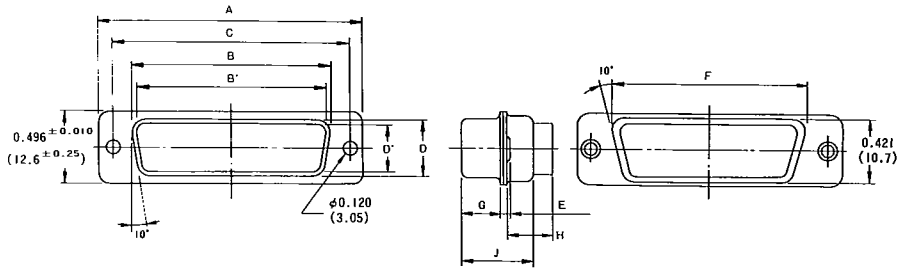

**D02F.  
FLOAT MOUNTING SHELL**  
(socket side only)

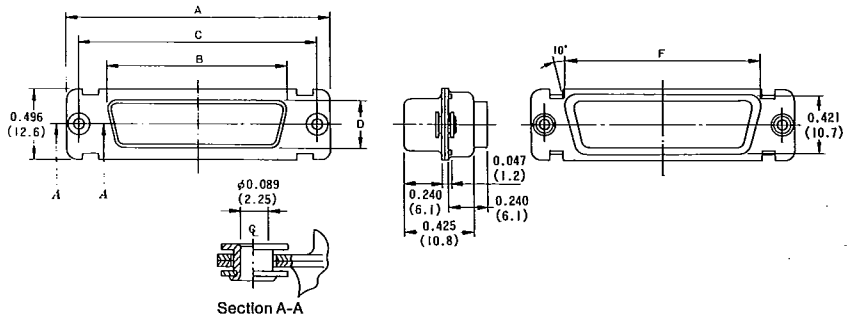
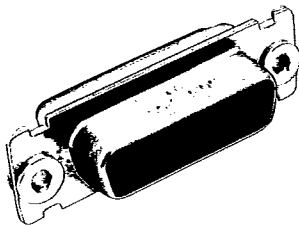

NOTE: Float mounted connector has .032 in. (0.81 mm) total diametral float.

No. of Contacts	Part Number	A ±0.020 (±0.5)	B ±0.010 (±0.25)	B' ±0.010 (±0.25)	C ±0.005 (±0.13)	D ±0.010 (±0.25)	D' ±0.010 (±0.25)	E ±0.020 (±0.5)	F ±0.016 (±0.4)	G ±0.016 (±0.4)	H ±0.020 (±0.5)	J ±0.031 (±0.8)
29	Pin side D02-29P-FO	1.539 (39.1)	—	.994 (25.24)	1.312 (33.32)	—	.328 (8.34)	.047 (1.2)	1.083 (27.5)	.236 (6.0)	.299 (7.6)	.421 (10.7)
	Socket side D02-29S-FO	1.539 (39.1)	.968 (24.59)	—	1.312 (33.32)	.308 (7.82)	—	.047 (1.2)	1.083 (27.5)	.240 (6.1)	.240 (6.1)	.425 (10.8)
50	Pin side D02-50P-FO	2.087 (53.0)	—	1.536 (39.01)	1.852 (47.04)	—	.331 (8.40)	.059 (1.5)	1.626 (41.3)	.236 (6.0)	.299 (7.6)	.421 (10.7)
	Socket side D02-50S-FO	2.087 (53.0)	1.508 (38.30)	—	1.852 (47.04)	.308 (7.82)	—	.047 (1.2)	1.626 (41.3)	.240 (6.1)	.240 (6.1)	.425 (10.8)

(Note) For float mounting shell (socket side only), add letter "F" after series prefix D02. Example... D02F-29S-FO

**CONTACTS FOR D02 SERIES**

**CRIMP CONTACTS**

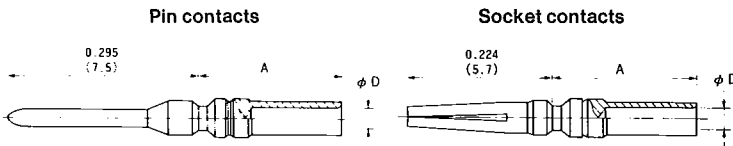

Contact Size	Part Number		Applicable Wire (AWG)
	Pin	Socket	
22-22	030-51451	030-51453	#22 ~ #24
22-26	030-51452	030-51454	#26 ~ #28

Contact Size	A	φD	Hand Crimp Tool		Insertion/ Extraction Tool
			Main body	Locator	
22-22	.226 (5.75)	.035 (0.89)	M22520/2-01	JP-D02	IE-D02-C
22-26	.222 (5.65)	.026 (0.66)			

**PCB THROUGH HOLE CONTACTS**

Part description: 030-51455 (Pin contact only)

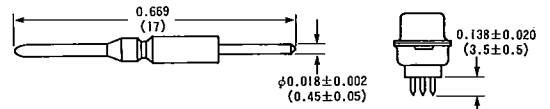

**PCB HOLE PATTERNS**

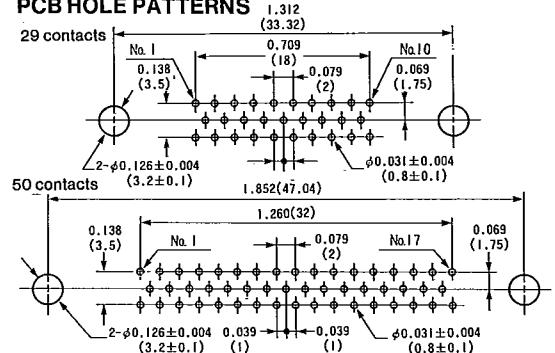

# DOUBLE DENSITY

## D02 SERIES CONNECTORS

The D02 series are high density connectors containing approximately twice as many contacts as D Sub connectors in the same shell size. The connectors are compact, light, and reliable. Both crimp contacts and printed circuit board through-hole contacts are available.

### FEATURES

• **Crimp contacts for easy wire connections**

Easy to use crimping tools significantly improve work efficiency. Contacts are inserted into the rear of the connector after wire termination.

• **Removable contacts**

The contacts can be removed easily using a simple tool in case of circuit changes or incorrect wiring.

• **Common accessories for D Sub series**

The connector body (shell) is the same as that of the other D Sub connectors, and therefore all standard accessories, such as a junction shells can be used.

• **Printed Circuit Board Mounting**

Through hole right angle contacts and straight (pin only) contacts for direct mounting (soldering) on a printed circuit board are also available. Connectors and contacts are ordered separately.

• **Crimping tools**

The manual tool is compact and easy to operate. Uniform, consistent results.

\* Refer to pages 64 to 67 for details on tool handling.

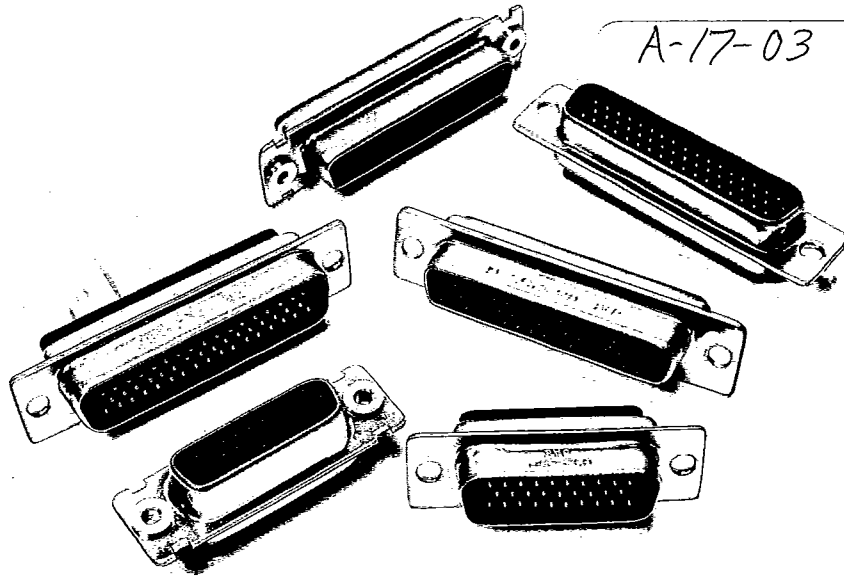
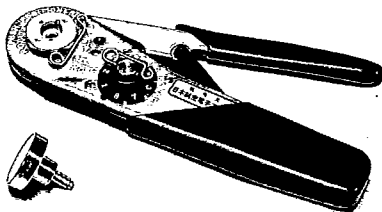

### HOW TO ORDER

## D02 -29P-FO D02F-29S-FO

- **FO:** Connector less contacts (not stamped on connector)
- **Contact type:** P... Pin, S... Socket
- **Contact arrangements:** 29 and 50
- **Mounting style:** No designator... Standard F... Float mount (Rear mount)
- **Series prefix**

NOTE: Connectors and contacts must be ordered separately.

### STANDARD DATA

• **Materials/Finishes**

	Material	Finish
Contacts	Copper alloy	Gold over nickel
Insulator	Synthetic resin	UL94V-0, black
Shell	Steel	Yellow chromate over zinc plate

• **Specifications**

No. of Contacts	29 and 50
Current Rating	3 amp max.
Voltage Rating	300 V AC r.m.s. max.
Dielectric Rating	900 V AC r.m.s (Initial)
Insulation Resistance	5,000 megohms min. (at 500 V DC)
Contact Resistance	10 milliohms max. (Initial)
Operating Temperature Range	-67°F ~ +185°F (-55°C ~ +85°C)

■ **Applicable wire**

AWG #22 to #28 stranded or solid

### CONTACT ARRANGEMENTS

Face view, Bin insert

29 contacts

50 contacts

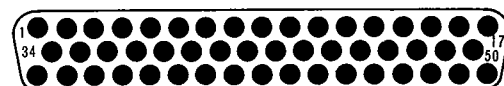
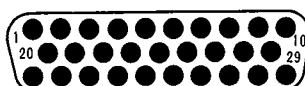

**FEATURES**

• **Five different shell sizes and numbers of conductors**

The connector housing is compact and rectangular. The contacts and insulators are contained in a rugged steel shell. There are five shell sizes (E, A, B, C, and D), respectively with standard contact counts of 9, 15, 25, 37, and 50. Special layouts to accept coaxial, high-voltage, and high-current contacts are also available.

E	A	Shell Size:
9	15	Number of Conductors:

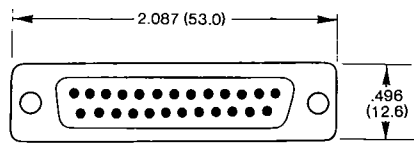
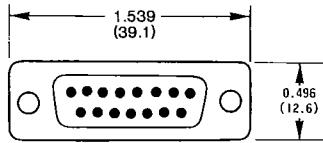
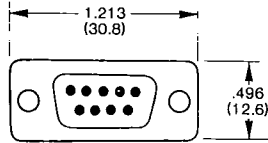

B	Shell Size:
25	Number of Conductors:

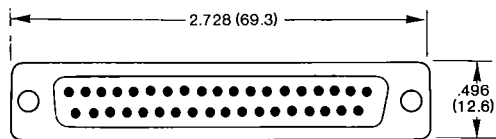

C	Shell Size:
37	Number of Conductors:

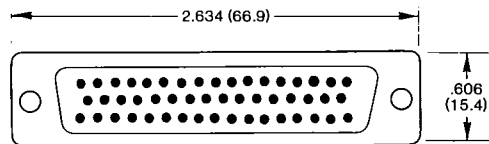

D	Shell Size:
50	Number of Conductors:

**Special Layouts (D\*M Type)**



• **Fail-Safe Polarizing Mechanism**

The shell connecting part is keystone trapezoidal which inherently prevents incorrect coupling.

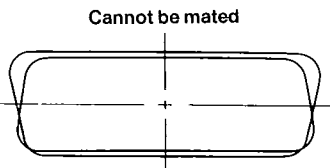
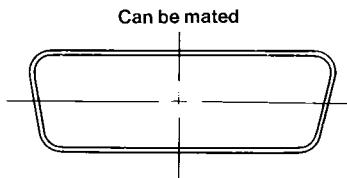

• **Official Standards**

D Sub connectors conform to many international standards including:

Japan Industrial Standards

JIS-C-6361

JIS-C-6366

JIS-C-6367

Japan Defense Agency Standards

NDSXC 6116

DSP C 6242

US Military Standards

MIL-C-24308

• **Shell Type**

The shell profile comes in a panel-mounting standard type and floating type (the latter aids in rack-to-panel connection).

A-17-03  
A-17-05  
A-61-11  
A-65-07

**Standard Type**

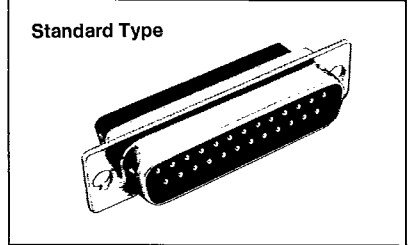

**Floating Type**

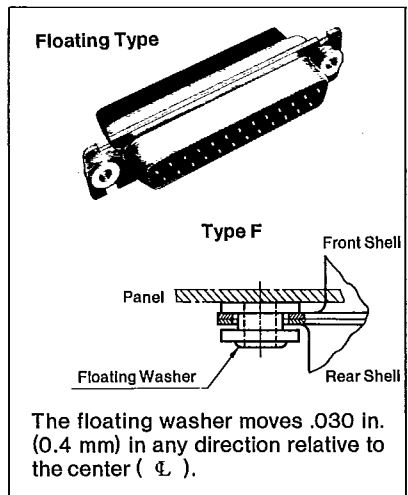

The floating washer moves .030 in. (0.4 mm) in any direction relative to the center (  $\phi$  ).

• **Close Entry Construction**

Socket insulators have a closed entry construction which prevents entry of oversized contacts or probes.

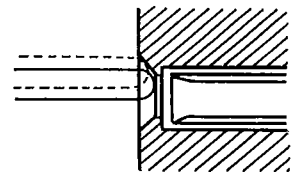

• **Compatibility**

Individual connector types are interchangeable as are the accessories.

## X-ON Electronics

Largest Supplier of Electrical and Electronic Components

*Click to view similar products for [D-Sub Contacts](#) category:*

*Click to view products by [JAE](#) manufacturer:*

Other Similar products are found below :

[D02-22-26S-10000](#) [8656352067LF](#) [131A15029X](#) [132J22039X](#) [132A11029X](#) [132A11049X](#) [132A12059X](#) [1757912-1](#) [188582-000](#)  
[162A11889X](#) [1757913-1](#) [212558-1](#) [030-1955-000](#) [053744-0098](#) [053744-0099](#) [053745-0105](#) [053745-0111](#) [601098N003](#) [D-610-10CS2962](#)  
[86303057NLF](#) [131A11019X](#) [162A11819X](#) [40-9854MP](#) [1-208778-5](#) [FC120N2](#) [MC7526D/AA](#) [MC8122D/AA](#) [FC4010D-15](#) [FC4006D](#)  
[121A05329A](#) [164C16669X](#) [86566620064LF](#) [131A13019X](#) [DLS3XS5AK40X](#) [09692825723](#) [030-1954-000](#) [L17DM53744207](#)  
[L17RRD1M11400](#) [030-1952-000](#) [030-1953-000](#) [030-1953-030](#) [132C11039X](#) [132J15019X](#) [132C15019X](#) [132A10039X](#) [131A10029X](#)  
[8638PSC2006LF](#) [8656453067LF](#) [86566520064LF](#) [L17DM537441](#)