

SJ100490
図面番号(DRAWING NO.)

版数 REV.	年月日 DATE	DCN NO.	変更内容 DESCRIPTION	製図 DR.	担当 CHK.	査閲 APPD.	承認 APPD.

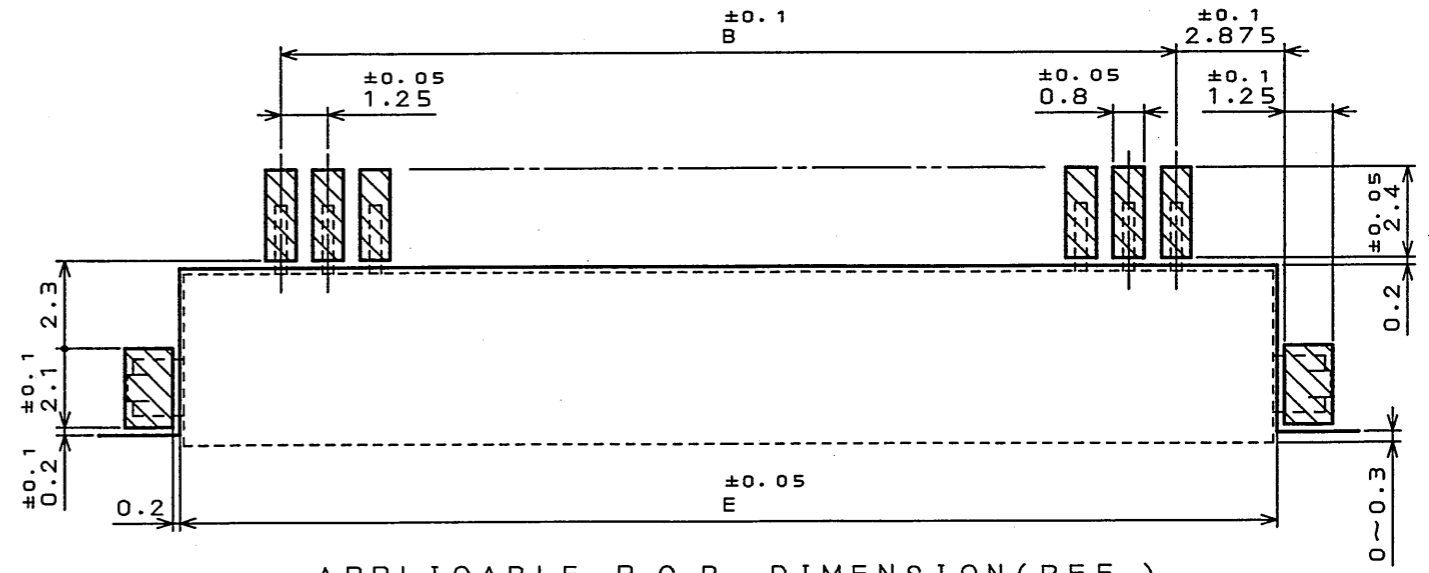

APPLICABLE P.C.B. DIMENSION (REF.)
適合基板寸法(参考)

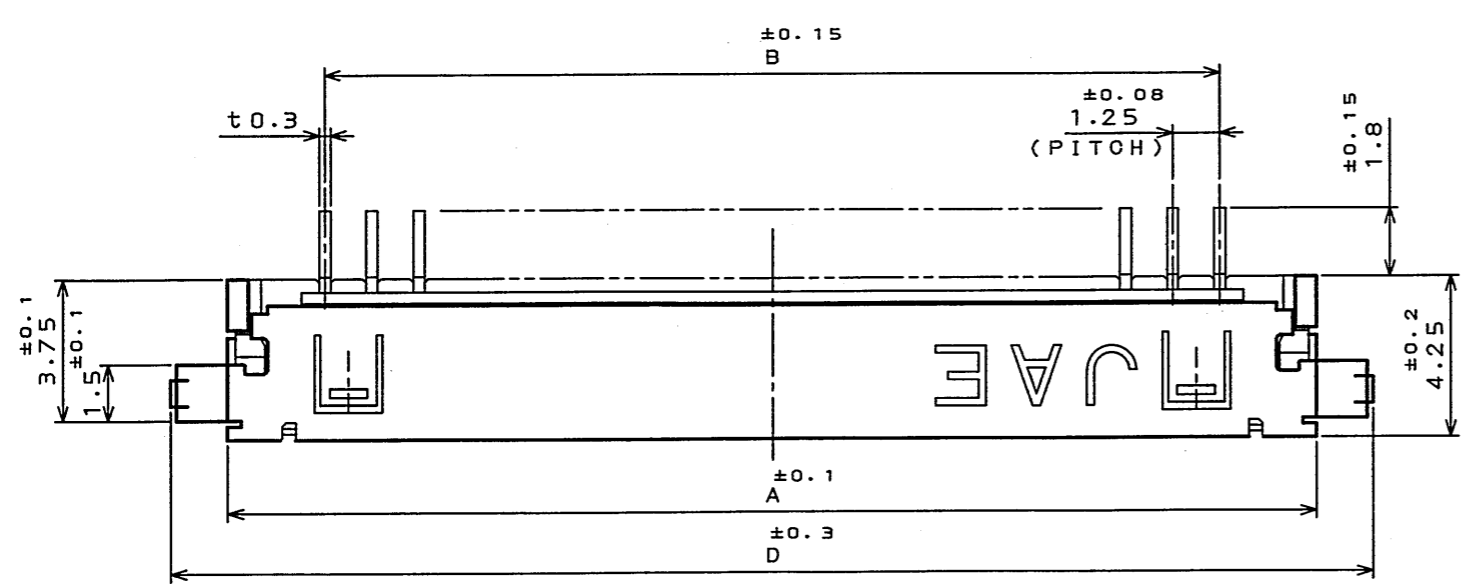
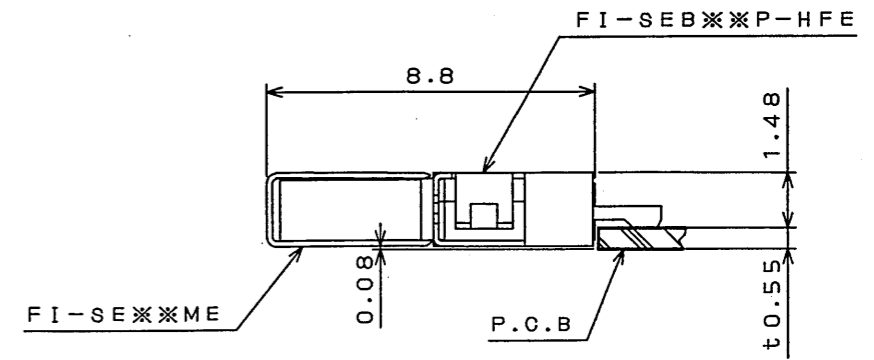
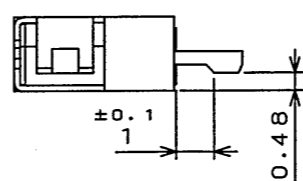
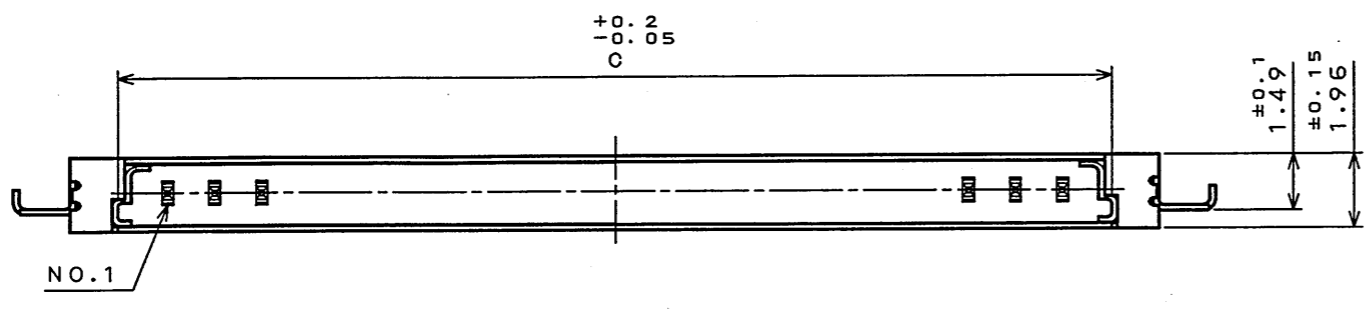

COUNTERPART CONNECTOR
相手側コネクタ

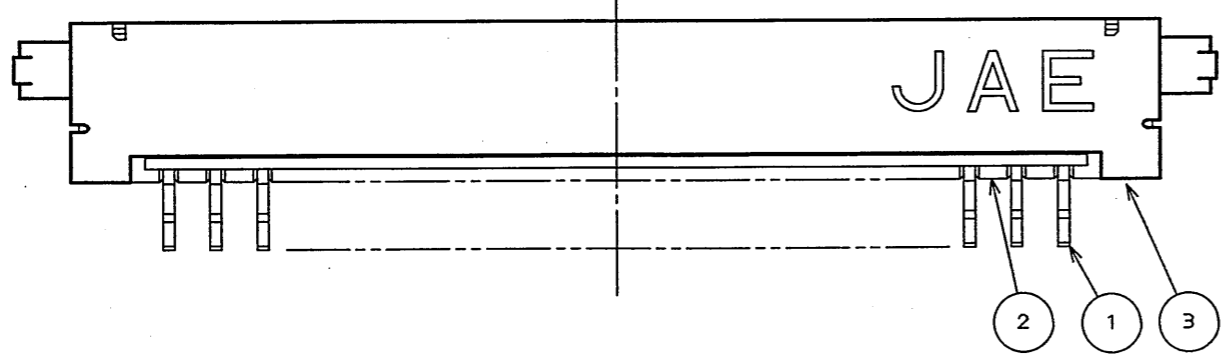
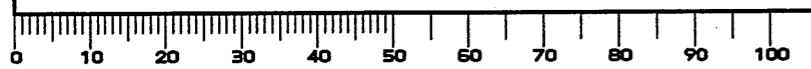

TABLE 1

DIMENSION NO. OF CONTACTS(N)	A	B	C	D	E
20	28.9	23.75	26.4	31.9	29.1

3	SHELL シェル	1	COPPER ALLOY 銅合金	TIN Snメッキ	
2	INSULATOR インシュレータ	1	GLASS FILLED LCP ガラス入りLCP		UL94-V-0 BEIGE (ベージュ)
1	CONTACT コンタクト	N	COPPER ALLOY 銅合金	GOLD OVER NICKEL Ni上部分Auメッキ	TERMINAL AREA: (LEAD FREE) TIN/TIN ALLOY OVER NICKEL 端子部: Ni上部分Auメッキ(無鉛)メッキ
符号 NO.	名称 DESCRIPTION	個数 QTY.	材料 MATERIAL	仕上 FINISH	備考 REMARKS
仕様書(SPECIFICATION)		第1版(ORIGINAL DATE) 10.Dec.2003		尺(SCALE) 5:1	日本航空電子工業株式会社
公差(GENERAL TOLERANCE)		製図 DR.	H.SAKURADA	名称(TITLE) Reference Only	
寸法(DIMENSION)		担当 CHK.	T.YAMAJI	JAPAN AVIATION ELECTRONICS INDUSTRY, LTD.	
角度(ANGLES)		査閲 APPD.	M. Suzuki	FI-SEB***P-HFE	
. ±0.8		承認 APPD.	Y. Ichizono	重量(WEIGHT)	
.X ±0.4				図面番号(DRAWING NO.)	
.XX ±0.1				SJ100490	
.XXX ±				版数 (REV.)	
				1	

DOF-0-212E(03.08)



LEAD FREE この製品は鉛フリー品です

JAE CONNECTOR DIV. PROPRIETARY.
COPYRIGHT(C) 2003, JAPAN AVIATION ELECTRONICS INDUSTRY, LTD.

X-ON Electronics

Largest Supplier of Electrical and Electronic Components

Click to view similar products for [FFC & FPC Connectors](#) category:

Click to view products by [JAE](#) manufacturer:

Other Similar products are found below :

[K-FC20](#) [FH29B-80S-0.2SHW\(99\)](#) [FPH-2022G](#) [AYF332735](#) [52610-1075](#) [52610-1275](#) [52610-1934](#) [501864-3091-TR225](#) [086222026001800](#)
[52610-0675](#) [62684-36210E9ALF](#) [52746-1671-TR250](#) [10051922-2810EHLF](#) [6-520415-9](#) [SFV6R-1STE9HLF](#) [XF3M-2915-1B-R100](#)
[1658549-1](#) [46214008010800](#) [AYF534065TA](#) [AYF351525](#) [086212040340800+](#) [AYF530365TA](#) [67000-014LF](#) [67000-004LF](#)
[006207341915000+](#) [DS1020-19RT1D](#) [67000-003LF](#) [67000-011LF](#) [67000-016LF](#) [HFW14R-2STE9LF](#) [SFV32R-2STBE9HLF](#) [SFW12R-](#)
[5STE9LF](#) [SFW18R-1STAE9LF](#) [SFW4R-5STE9LF](#) [52807-0430](#) [046283021002868+](#) [THD1015-8CL-SN](#) [67000-006LF](#) [502250-8027](#)
[104267-9617](#) [66987-011LF](#) [AYF362535](#) [F0501-T-50-20T-R](#) [HFW8S-2STAE1HLF](#) [67000-008LF](#) [67000-012LF](#) [ECC576069EU](#) [F1002-B-](#)
[20-20T-R](#) [HFW15S-2STAE1HLF](#) [0781271110](#)