

SJ100490
図面番号(DRAWING NO.)

| 版数 REV. | 年月日 DATE | DCN NO. | 変更内容 DESCRIPTION | 製図 DR. | 担当 CHK. | 査閲 APPD. | 承認 APPD. |
|------------|-------------|---------|---------------------|-----------|------------|-------------|-------------|
| | | | | | | | |
| | | | | | | | |

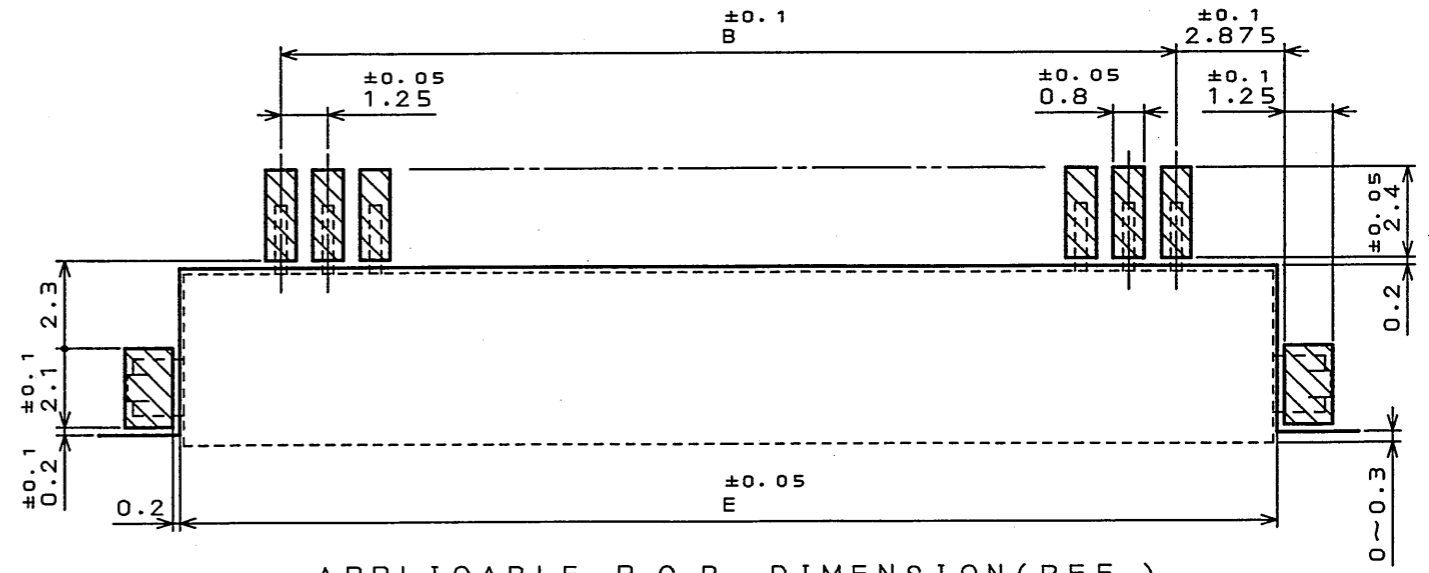

APPLICABLE P.C.B. DIMENSION (REF.)
適合基板寸法(参考)

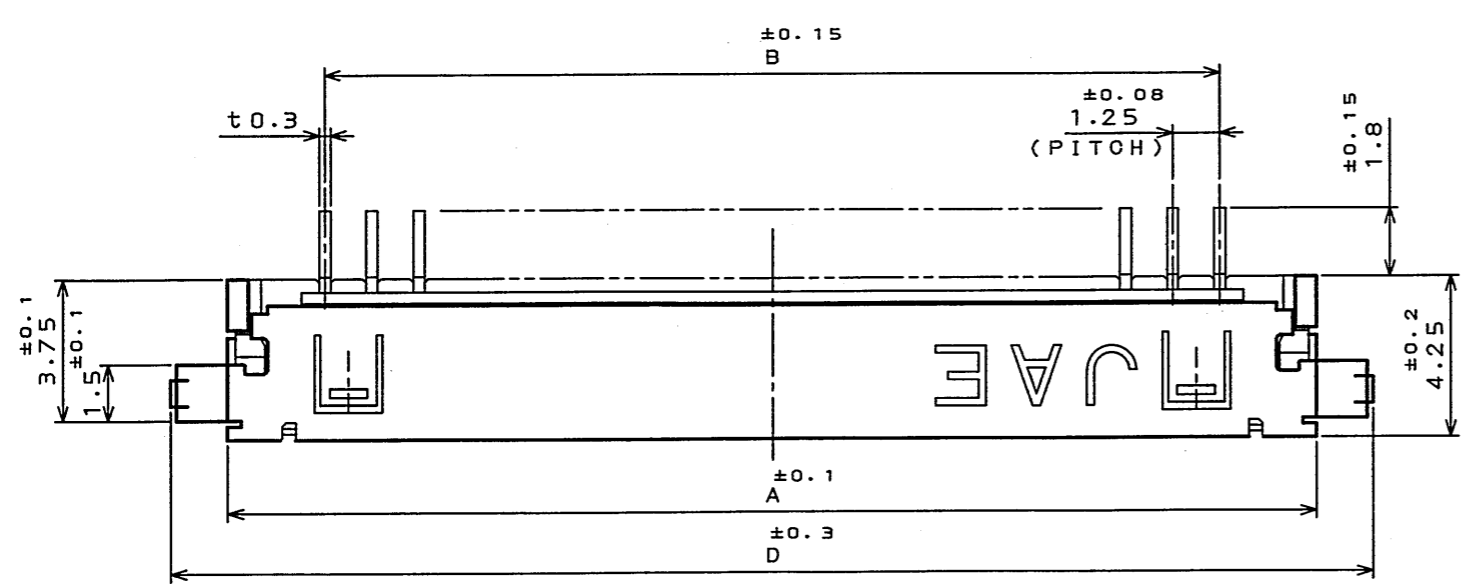
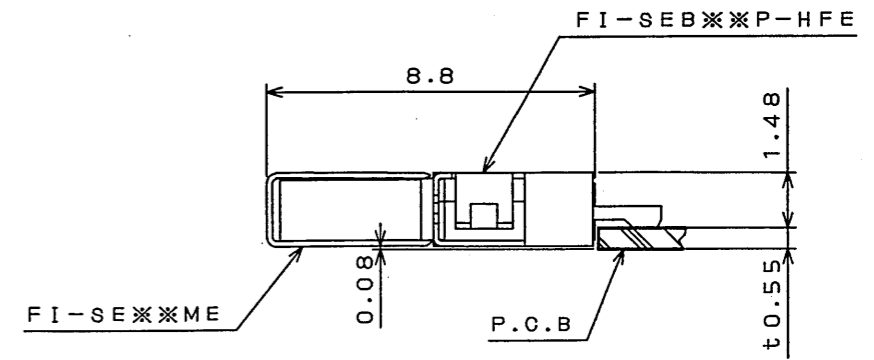
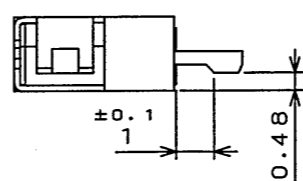
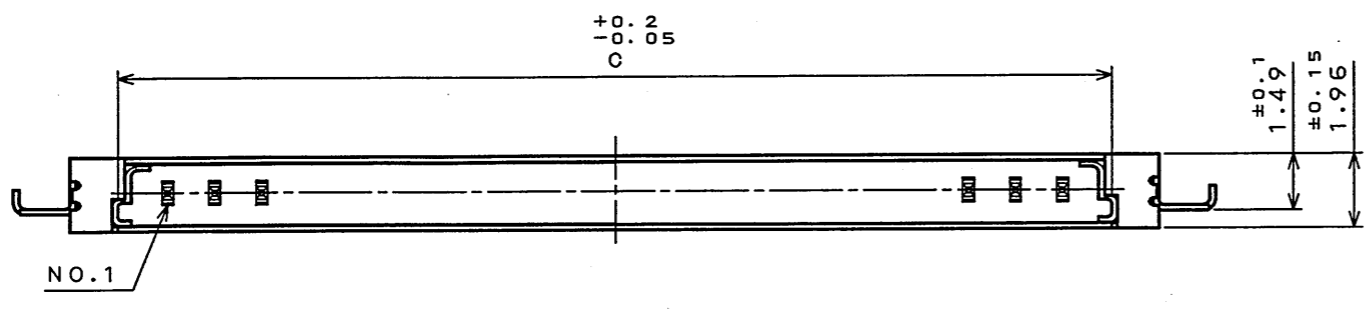

COUNTERPART CONNECTOR
相手側コネクタ

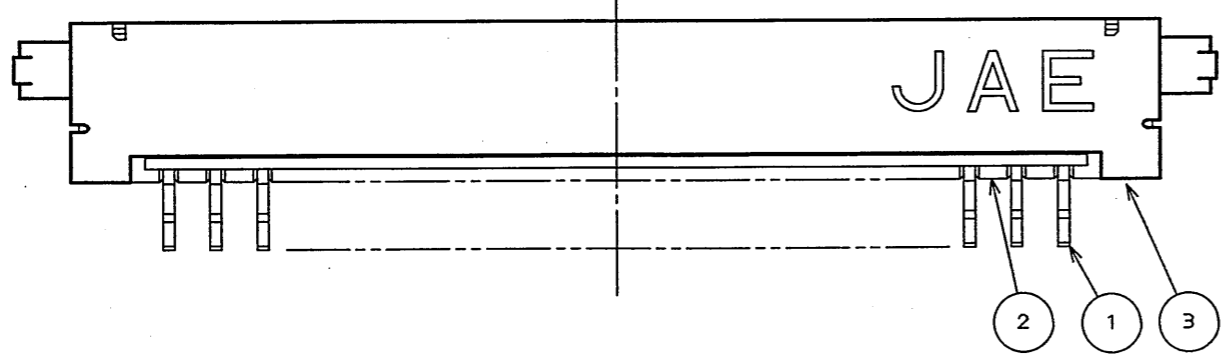

| 符号 NO. | 名称 DESCRIPTION | 個数 QTY. | 材料 MATERIAL | 仕上 FINISH | 備考 REMARKS |
|------------------------|----------------------|------------------------------------|------------------------------|---|---|
| 3 | SHELL シェル | 1 | COPPER ALLOY 銅合金 | TIN Snメッキ | |
| 2 | INSULATOR インシュレータ | 1 | GLASS FILLED LCP ガラス入りLCP | | UL94-V-0 BEIGE (ベージュ) |
| 1 | CONTACT コンタクト | N | COPPER ALLOY 銅合金 | GOLD OVER NICKEL Ni上部分Auメッキ | TERMINAL AREA: (LEAD FREE) TIN/TIN ALLOY OVER NICKEL 端子部: Ni上部分Auメッキ(無鉛)メッキ |
| 仕様書 (SPECIFICATION) | | 第1版 (ORIGINAL DATE) 10.Dec.2003 | | 尺 (SCALE) 5:1 | |
| 公差 (GENERAL TOLERANCE) | | 製図 DR. H.SAKURADA | | 名称 (TITLE) FI-SEB***P-HFE | |
| 寸法 (DIMENSION) | | 担当 CHK. T.YAMAJI | | 製図 DR. H.SAKURADA | |
| 角度 (ANGLES) | | 査閲 APPD. M. Suzuki | | 承認 APPD. Y. Ichizoma | |
| . ±0.8 | | ° ± | | 重量 (WEIGHT) | |
| .X ±0.4 | | °X ± | | JAE CONNECTOR DIV. PROPRIETARY. | |
| .XX ±0.1 | | .XXX ± | | COPYRIGHT (C) 2003, JAPAN AVIATION ELECTRONICS INDUSTRY, LTD. | |
| .XXX ± | | | | 図面番号 (DRAWING NO.) SJ100490 | |
| | | | | 版数 (REV.) 1 | |

TABLE 1

| DIMENSION NO. OF CONTACTS (N) | A | B | C | D | E |
|----------------------------------|------|-------|------|------|------|
| 20 | 28.9 | 23.75 | 26.4 | 31.9 | 29.1 |

DOF-0-212E(03.08)

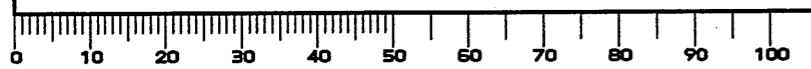

LEAD FREE この製品は鉛フリー品です

JAE CONNECTOR DIV. PROPRIETARY.
COPYRIGHT (C) 2003, JAPAN AVIATION ELECTRONICS INDUSTRY, LTD.

X-ON Electronics

Largest Supplier of Electrical and Electronic Components

Click to view similar products for [FFC & FPC Connectors](#) category:

Click to view products by [JAE](#) manufacturer:

Other Similar products are found below :

[00-6200-227-022-800](#) [006205250500825+](#) [006205280500825+](#) [FPH-1602G](#) [086222026001800](#) [52610-0675](#) [62674-201121DLF](#) [52746-1671-TR250](#) [10051922-1610EHLF](#) [10051922-2810EHLF](#) [686322124422](#) [XF3M-2915-1B-R100](#) [AYF353125A](#) [AYF530665TA](#) [AYF534065TA](#) [20FLH-RSM1-TB](#) [207356-1](#) [SFW12R-5STE9LF](#) [SFW18R-1STAE9LF](#) [SFW4R-5STE9LF](#) [52807-0430](#) [046283021002868+](#) [FFC05011-10SBB114W5M](#) [502250-8027](#) [67000-008LF](#) [200528-0260](#) [FH28K-10S-0.5SH](#) [FH52K-6S-0.5SH](#) [0.5K-DX-30PWB](#) [DS1020-08-10VBT12](#) [THD0515-34CL-GF](#) [X05A10L28G](#) [ECC2841061EU](#) [1.0K-DHQX-16PWB](#) [1.0K-DHQX-30PWB](#) [1775333-6](#) [10054365-202110ELF](#) [10054365-242110ELF](#) [10054365-282110ELF](#) [10064555-392220HLF](#) [59453-041110EBHLF](#) [59453-091110EDHLF](#) [62674-241141ALF](#) [62684-432100ALF](#) [62684-451100AHLF](#) [62684-5721N0ALF](#) [HFW11R-1STE1MTLF](#) [HFW12R-1STE9LF](#) [HFW14R-1STE9MTLF](#) [HFW18S-2STE9LF](#)