

版数 REV.	年月日 DATE	DCN NO.	変更内容 DESCRIPTION	製図 DR.	担当 CHK.	査閲 APPD.	承認 APPD.
------------	-------------	---------	---------------------	-----------	------------	-------------	-------------

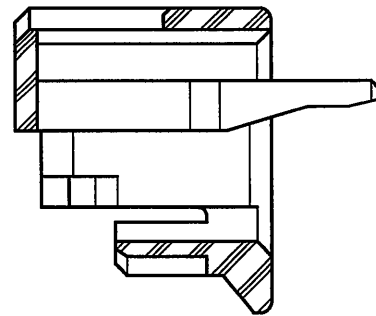

SECT. A-A
(SCALE 5:1)

(MATERIAL MARK)

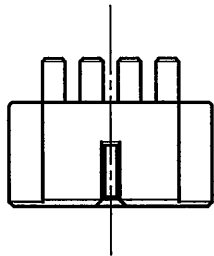
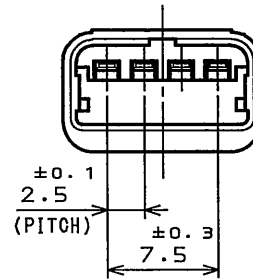
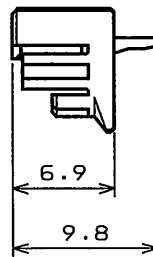
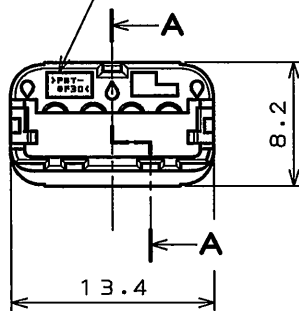

特別管理品目
SPECIAL CONTROL ITEM
MX (SRS)

DOF-0-211E(03.08)

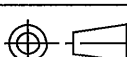
1	FRONT RETAINER	1	PBT-GF30	—	COLOR: BLACK
符号 NO.	名称 DESCRIPTION	個数 QTY.	材料 MATERIAL	仕上 FINISH	備考 REMARKS
仕様書 (SPECIFICATION) JAOS-10220 JAHL-10220		第1版 (ORIGINAL DATE) 4.Feb.2005		名称 (TITLE) MX36004XF3	
公差 (GENERAL TOLERANCE)		製図 DR.	H.HASHIMOTO	JAPAN AVIATION ELECTRONICS INDUSTRY, LTD. 	
寸法 (DIMENSION)		担当 CHK.	M.WATANABE		
角度 (ANGLES)		査閲 APPD.	—		
		承認 APPD.	A.Chino / Y.HIROSE		
· ±0.8	×° ±			FRONT RETAINER	
·X ±0.4	×°X ±			シリーズ (SERIES) 尺度 (SCALE)	
·XX ±0.1				MX36 2:1	
·XXX ±				図面番号 (DRAWING NO.) SJ102923	
				版数 (REV.) 1	

X-ON Electronics

Largest Supplier of Electrical and Electronic Components

Click to view similar products for [Automotive Connectors](#) category:

Click to view products by [JAE](#) manufacturer:

Other Similar products are found below :

[003-018-000](#) [60403001](#) [60993906-B](#) [M902-2131](#) [M902-2161](#) [72.330.1035.1](#) [73.353.4028.0](#) [F119300-B](#) [F166900](#) [F258300-B](#) [F358300-B](#)
[F407400](#) [F444110](#) [F487000](#) [F509500B-B](#) [827153-1](#) [8N1515-32-24P](#) [9-1326729-8](#) [925474-1](#) [928905-1](#) [964562-4](#) [968782-1](#) [GT17SA-8DS-](#)
[HU](#) [98891-1012](#) [98947-1016](#) [12004475-L](#) [12010290](#) [12010309-B](#) [12015454](#) [12020219-B](#) [12020308](#) [12041318-B](#) [12052225-L](#) [12052466](#)
[12059125](#) [12064869](#) [12004327-B](#) [12010503-B](#) [12015308](#) [12015384](#) [12015909](#) [1-21030-1](#) [12041254](#) [12041318](#) [12047946-B](#) [12047957](#)
[12047957-L](#) [12059473](#) [12066261](#) [12110546](#)