



Automotive USB 2.0 Standard Compatible Connector

CONNECTOR

MX49 Series

MB-0252-1

October 2012

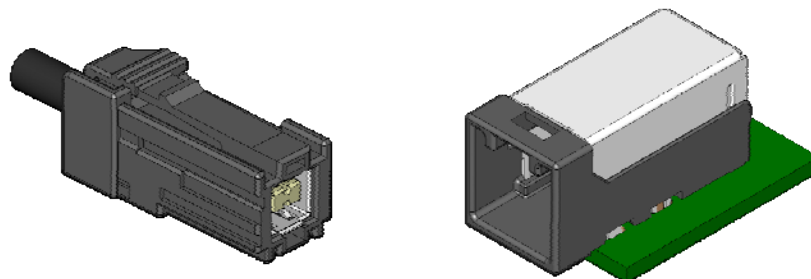

Recently for car navigation systems, USB connectivity with hand-held digital audio players and smartphones, and the functions to play audio and images from those devices, has been increasing.

And as the features in car navigation systems become ever more advanced and the number of parts mounted on the board increases, there is a demand for smaller connectors.

To meet these demands, JAE has developed the MX49 Series of connectors for automotive USB 2.0 transmission.

The MX49 Series has a reduced height, width and depth compared to our previous product, achieving a 48% reduction in volume.

The MX49 Series is compatible with high-speed signals and has transmission performance that satisfies the USB 2.0 standard. The MX49 Series also features the environment resistance that is required for an automotive connector.

Features

- Achieves a 48% reduction in volume compared to our previous product.
- 2.0mm pitch, 2 rows, 4 position (2 signal lines, power, ground)
- Compatible with USB 2.0 standard transmission.
- Board connector is available in DIP type and reflow type.
- Different keying versions available for mis-mating prevention.
(DIP type: 5 versions; reflow type: 4 versions)
- Mechanical lock and twist-resistant structure for mated connector.
- Dual-shield structure with ground terminals for EMI control.
- Available as a completed harness to ensure transmission performance reliability.

General Specifications

- No. of Contacts: 4 positions
- Dielectric Withstanding Voltage: AC1000 Vr.m.s. (applied voltage) per minute (mated condition)
- Operating Temperature: -40 Deg. C to +85 Deg. C
- Insulation Resistance: 100M Ω min. (mated condition)
- Applicable Board Thickness: 1.6mm
- Applicable Wire: Signal line is shielded twisted pair wire (for harness)
- Connector Insertion Force: 70N max.

Materials and Finishes

■ Angle Pin Connector

Component	Material / Finish
Signal / Power Terminal	Brass / Contact Area: Au plating over Ni Board Termination Area: Sn plating
External Housing	DIP Type: SPS-GF30 Reflow Type: PPS-GF40
Internal Housing	DIP Type: SPS-GF30 Reflow Type: LCP-GF35
Ground Terminal	Copper alloy / Sn plating
Shield Shell	DIP Type: Copper alloy / Sn plating Reflow Type: Brass / Sn plating

■ Socket Connector

Component	Material / Finish
Signal / Power Terminal	Copper alloy / Contact Area: Au plating over Ni Wire Termination Area: Sn plating
External Housing Retainer	PBT
Internal Housing Holder	LCP-GF35
Ground Terminal	Copper alloy / Sn plating
Cover Shell Sleeve	Brass / Sn plating

Angle Pin Connector DIP (MX49004NQ1) Drawing No.: SJ110136

Unit: mm

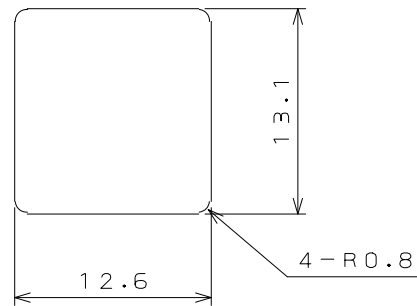
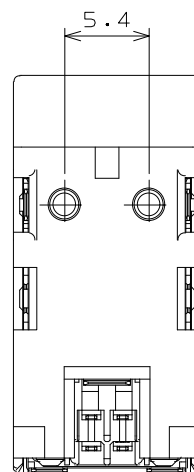
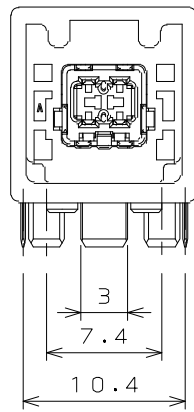
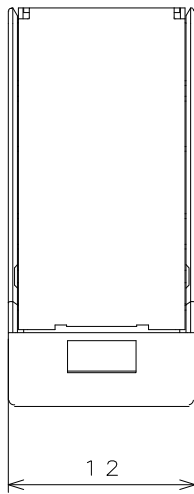

PANEL CUT OUT DIMENSION (REF.)

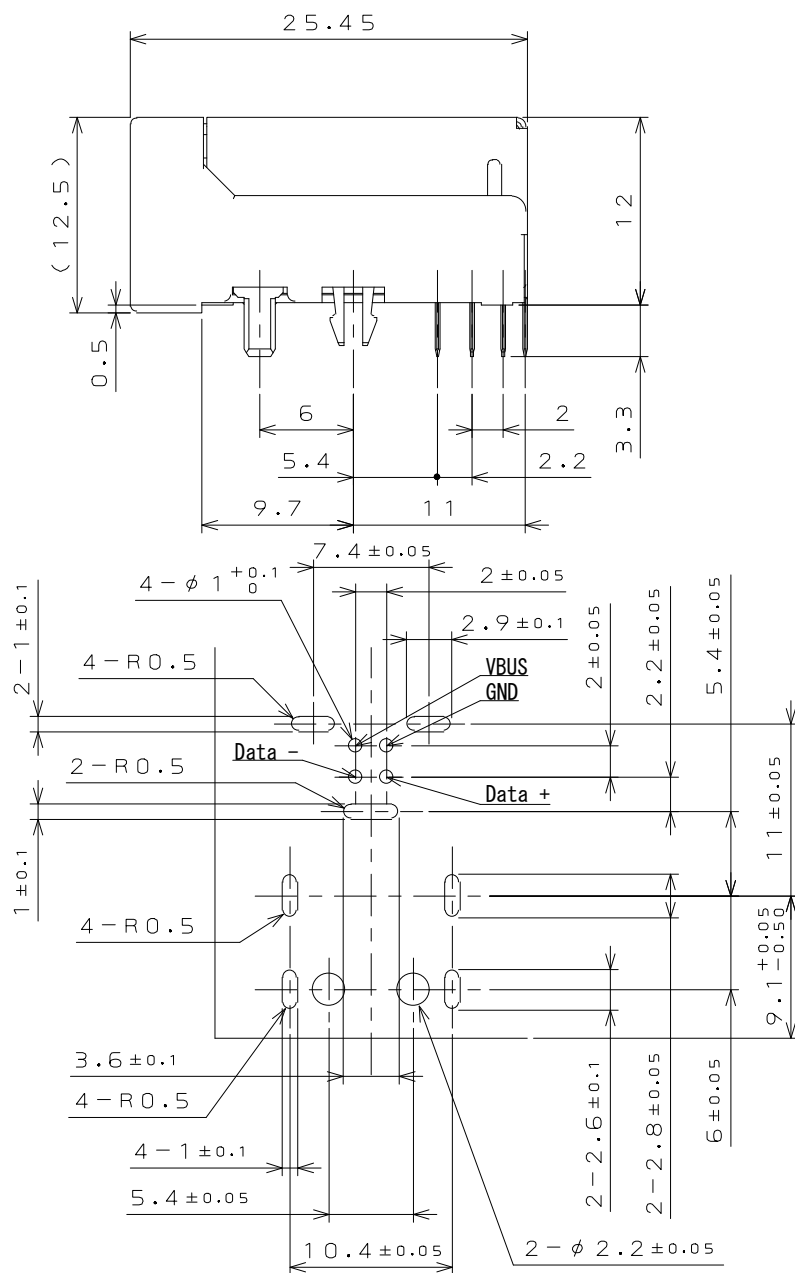

APPLICABLE P.C.B. DIMENSION (REF.)

Angle Pin Connector Reflow Type (MX49004HQ1) Drawing No.: SJ110812

Unit: mm

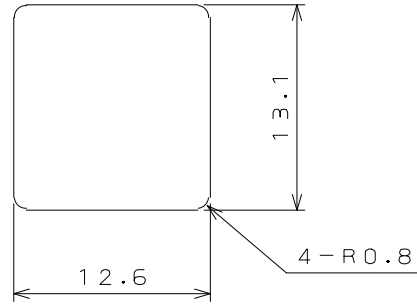
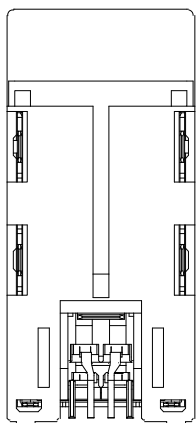
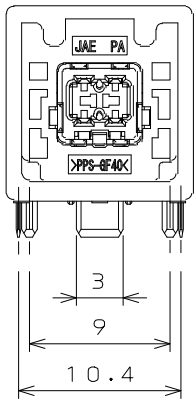
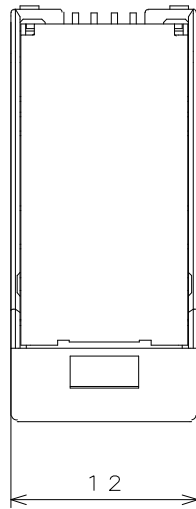

PANEL CUT OUT DIMENSION (REF.)

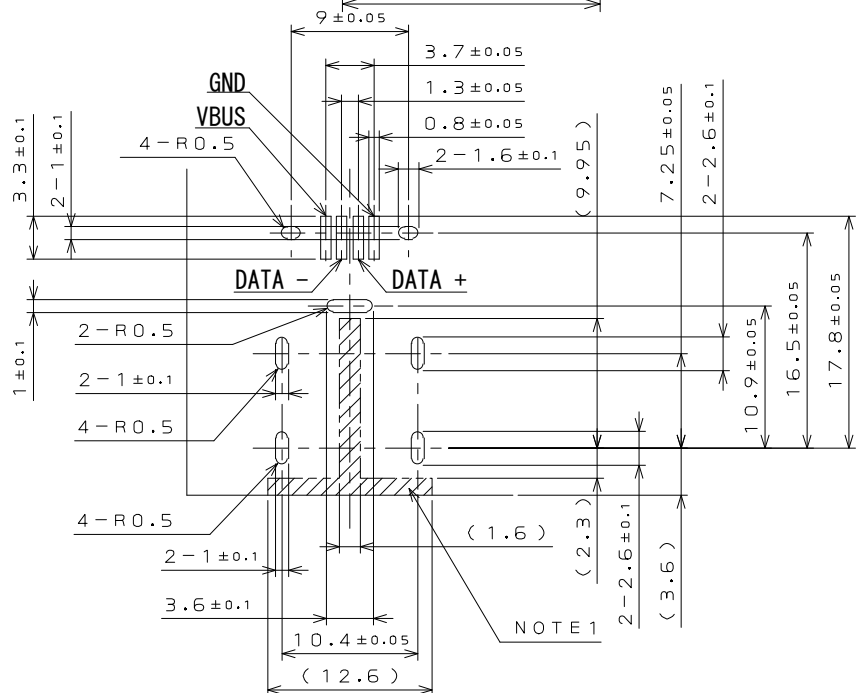
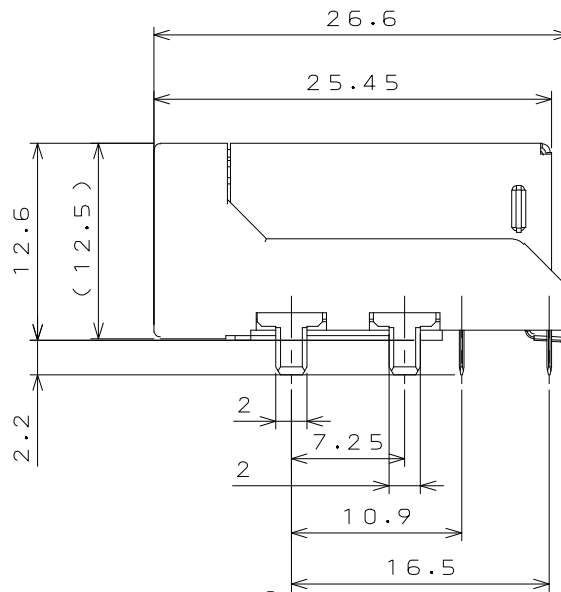











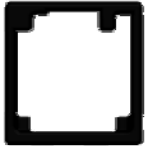

APPLICABLE P.C.B. DIMENSION (REF.)

Note 1: Shaded portion of this drawing is pattern prohibited area.

■ Key Type (Shape) / Insulator Color

Unit: mm

Key Type	Socket Connector	Pin Connector		External Insulator Color
		DIP Type	Reflow Type	
A				Gray
B				Black
C				Brown
D				Green
E			/	Light Blue

■ Socket Connector (for reference)

Unit: mm

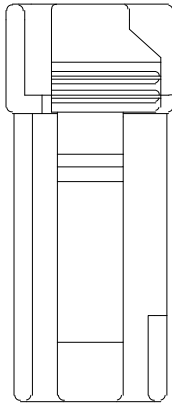

Note:

**Socket connector is a harness product.
It is not sold as an individual connector.**

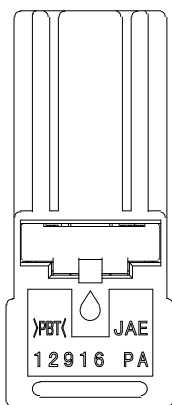
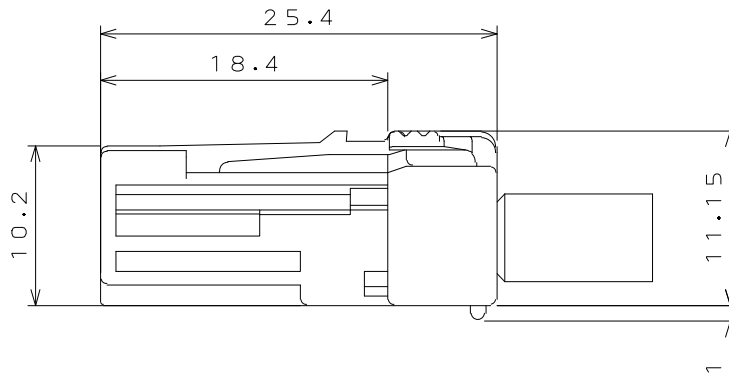
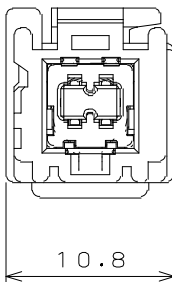

Other

Specifications

JACS-10656

Notice: Products shown in this brochure are made for the applications listed below. However, if the above-mentioned products are to be used in aerospace devices, marine cable-connection devices, atomic power control systems, medical equipment for life-support systems, or any other specific application requiring extremely high reliability, please contact JAE for further information.
Recommended applications: Computers, Office machines, Measuring devices, Telecommunication devices (Terminals, Mobile devices), AV devices, Household applications, FA devices, etc.

Japan Aviation Electronics Industry, Limited

Product Marketing Division
Aobadai Building, 3-1-19, Aobadai, Meguro-ku, Tokyo 153-8539
Phone: +81-3-3780-2787 FAX: +81-3-3780-2946

* The specifications in this brochure are subject to change without notice. Please contact JAE for information.

X-ON Electronics

Largest Supplier of Electrical and Electronic Components

Click to view similar products for [Automotive Connectors](#) category:

Click to view products by [JAE](#) manufacturer:

Other Similar products are found below :

[003-018-000](#) [60403001](#) [60993906-B](#) [M902-2131](#) [M902-2161](#) [72.330.1035.1](#) [73.353.4028.0](#) [F119300-B](#) [F166900](#) [F258300-B](#) [F358300-B](#)
[F407400](#) [F444110](#) [F487000](#) [F509500B-B](#) [827153-1](#) [8N1515-32-24P](#) [9-1326729-8](#) [925474-1](#) [928905-1](#) [964562-4](#) [968782-1](#) [GT17SA-8DS-](#)
[HU](#) [98891-1012](#) [98947-1016](#) [12004475-L](#) [12010290](#) [12010309-B](#) [12015454](#) [12020219-B](#) [12020308](#) [12041318-B](#) [12052225-L](#) [12052466](#)
[12059125](#) [12064869](#) [12004327-B](#) [12010503-B](#) [12015308](#) [12015384](#) [12015909](#) [1-21030-1](#) [12041254](#) [12041318](#) [12047946-B](#) [12047957](#)
[12047957-L](#) [12059473](#) [12066261](#) [12110546](#)