

Compact Low-profile Connector

CONNECTOR

MX77 Series

MB-0326-2

Jul.2020

RoHS Compliant

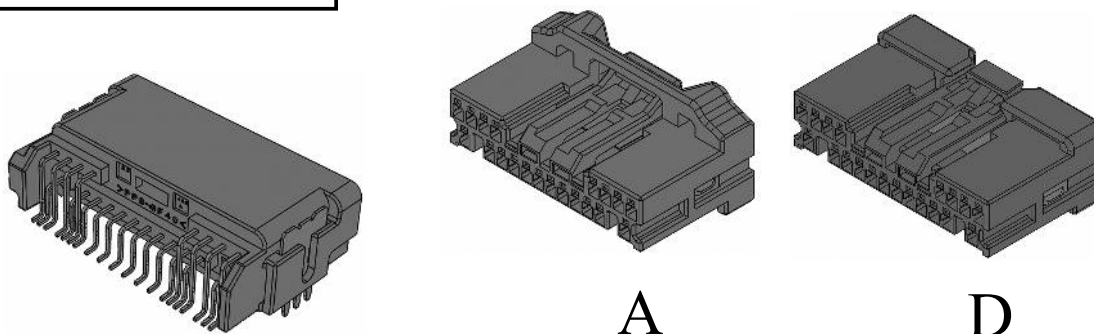

To cater to the demand for compact and low profile automotive connectors, an MX77D variation featuring 0.4mm tab size with added height-reduction has been added to the MX77 Series lineup.

Applicable Market

General purpose automotive electrical control units (ECU), battery system components for electric vehicles (EV), and battery management system applications (BMS), flame-retardant material

Features

- Ultra compact type 0.4mm tab size (pin width)
- Pin header side insulator uses flame-retardant UL94 V-0 material
- Socket side (cable connection) offers two housing models.
- MX77D FLRY-B 0.35mm² cable is suggested for socket side cavities.
- The pin side are SMT-mounted to save space, and are fixed to the board by soldering the legs to the board using a through-hole reflow process to ensure sufficient strength
- USCAR2 tested

General Specifications

Number of Contacts	4, 8, 12, 16, 20, 24, 32, 40
Rated Current	3A
Operating Temperature	-40°C ~ +85°C
Maximum Operating Temperature	130°C (Ambient temperature + temperature rise due to conduction)
Contact Resistance	Initial: 5mΩ max., posttest: 10mΩ max.

Ordering Information

MX77 A 004 S F 1

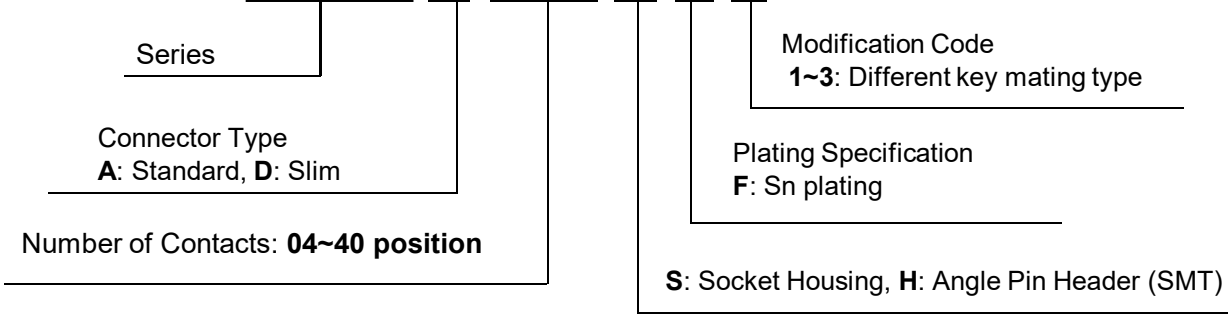

Materials and Finishes

Socket Housing

Component	Material
Housing	PBT
Retainer	PBT

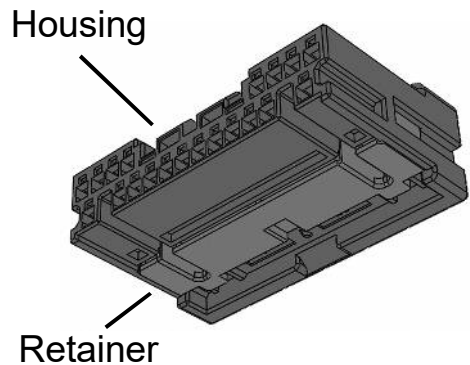

Angle Pin Header

Component	Material / Finish
Housing	PPS-GF40
Contact	Copper Alloy / Sn plating
Leg	Brass / Sn plating

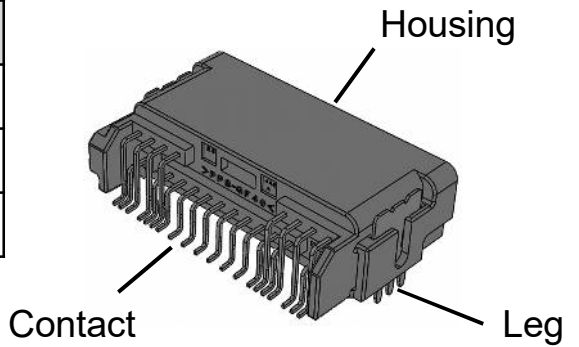

Socket Contact

Component	Material / Finish
Contact	Copper Alloy / Sn plating

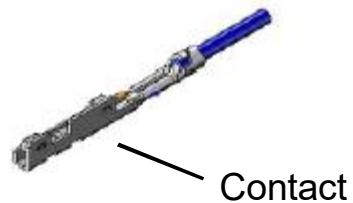

Part Number and Drawings

Socket Housing / Angle Pin Header

Number of Contacts	Socket Housing					Angle Pin Header (SMT)	
	MX77A: Standard type		MX77D: Slim type			Part Number	Drawing
	Part Number	Drawing	Part Number	Drawing			
4	MX77A004SF1	SJ115705			⇔	MX77A004HF1	SJ115704
			MX77D004SF2 (Note 1)	SJ120951	⇔	MX77A004HF2 (Note 1)	SJ120666
			MX77D004SF3 (Note 1)	SJ120952	⇔	MX77A004HF3 (Note 1)	SJ120667
8	MX77A008SF1	SJ114912	MX77D008SF1	SJ120953	⇔	MX77A008HF1	SJ114911
12	MX77A012SF1	SJ113564	MX77D012SF1	SJ120954	⇔	MX77A012HF1	SJ113562
16	MX77A016SF1	SJ114782	MX77D016SF1	SJ120955	⇔	MX77A016HF1	SJ114781
20	MX77A020SF1	SJ113936	MX77D020SF1	SJ122094	⇔	MX77A020HF1	SJ113935
24	MX77A024SF1	SJ114910	MX77D024SF1	SJ122095	⇔	MX77A024HF1	SJ114909
32	MX77A032SF1	SJ114908	MX77D032SF1	SJ120956	⇔	MX77A032HF1	SJ114907
40	MX77A040SF1	SJ113563	MX77D040SF1	SJ120957	⇔	MX77A040HF1	SJ113561

Note 1) This product is different key mating type.

Socket Contact

Part Number	Drawing	Applicable Cable
MX77S13K5F1	SJ113565	CHFUS 0.13mm ² , CIVUS 0.13mm ²
MX77S13K4F2	SJ113566	CHFUS 0.22mm ² , CIVUS 0.22mm ²
MX77S13K4F1	SJ116307	CHFUS 0.35mm ² , CIVUS 0.35mm ² FLRY-B 0.3mm ² (Note 2) AVSS 0.3mm ² (Note 3)

Note 2) FLRY-B cable is compatible with all cavity for MX77D type, however it is limited for MX77A. (Please refer to drawing of housing for details)

Note 3) AVSS cable is limited to applicable cavity. (Please refer to drawing of housing for details)

• Handling Instruction for Crimp tool for Socket Contact is a below.

Applicable Contact	Hand Crimp Tool	Semi-automatic Applicator	Automatic Applicator
MX77S13K5F1	—	3502-MX77-2 (T703573)	3502-MX77-3B (Please contact us for details)
MX77S13K4F2	—		
MX77S13K4F1	CT150-2-MX77 (T700444)		

• Extraction tool for Socket contact is "ET-MX77-1" (T711240).

Technical Documents

	Specifications	Handling Instructions
Socket Housing: MX77D type	JACS-11086-1	JAHL-11086-1
For items other than above	JACS-11086	JAHL-11086

Outer Dimensions

Socket Housing

MX77A: Standard type

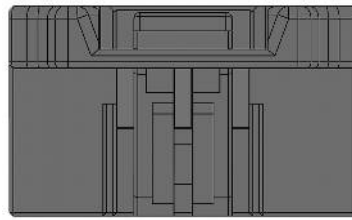

*Drawing of 20 position type

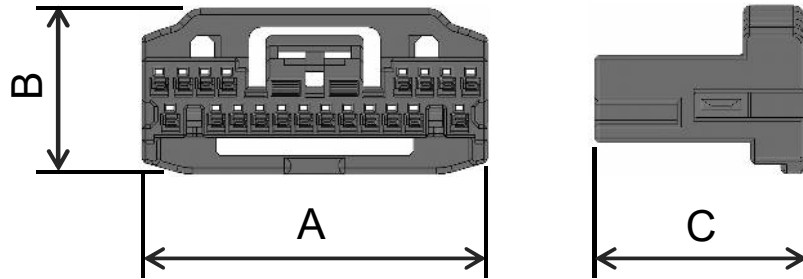

MX77D: Slim type

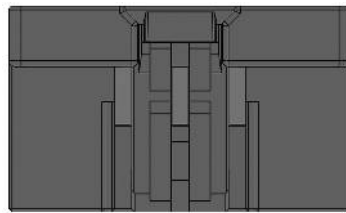

*Drawing of 20 position type

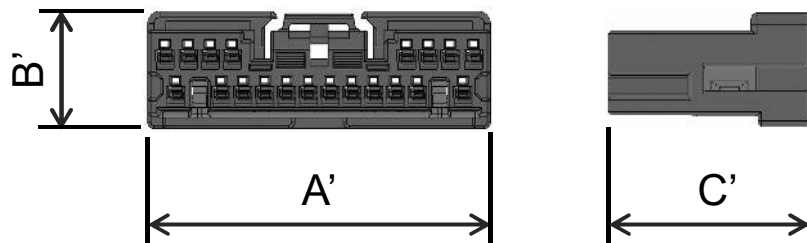

Unit: mm

	MX77A: Standard type			MX77D: Slim type		
Number of Contacts	Dimension A	Dimension B	Dimension C	Dimension A'	Dimension B'	Dimension C'
4 positon	11.9	12.5	17	11.9	9.5	17
8 positon	15.7	13.5		15.7		
12 positon	21.1			21.1		
16 positon	24.7			24.7		
20 positon	28.3			28.3		
24 positon	31.9			31.9		
32 positon	39.7			39.7		
40 positon	46.9			46.9		

Outer Dimensions

Angle Pin Header

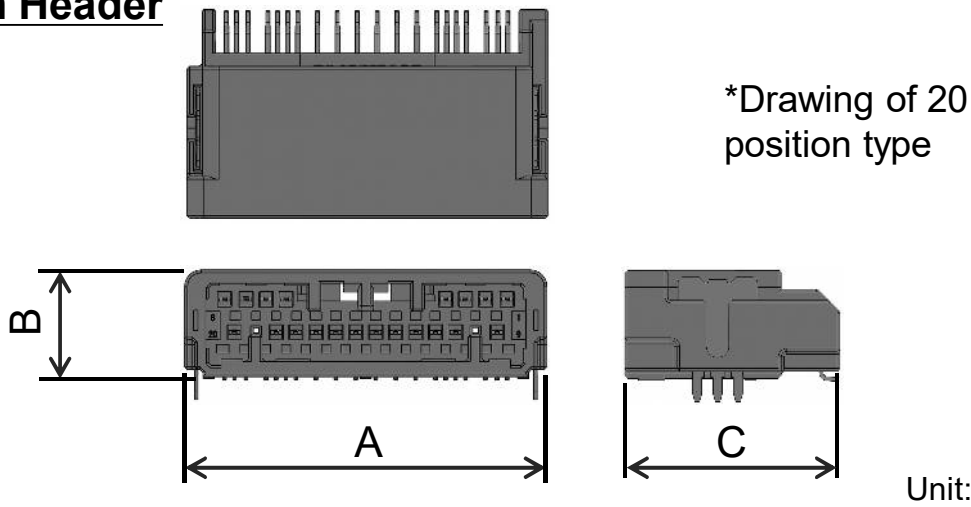

Number of Contacts	Dimension A	Dimension B	Dimension C
4 positon	15.8	9.7	19
8 positon	20.1		
12 positon	25.5		
16 positon	29.1		
20 positon	32.7		
24 positon	36.3		
32 positon	44.1		
40 positon	51.3		

Notice:

- The values specified in this brochure are only for reference. The products and their specifications are subject to change without notice. Contact our sales staff for further information before considering or ordering any of our products. For purchase, a product specification must be agreed upon.
- Users are requested to provide protection circuits and redundancy circuits to ensure safety of the equipment, and sufficiently review the suitability of JAE's products to the equipment.
- The products presented in this brochure are designed for the uses recommended below. We strongly suggest you contact our sales staff when considering use of any of the products in any other way than the recommended applications or for a specific use that requires an extremely high reliability.
 - Applications that require consultation:
 - Please contact us if you are considering use involving a quality assurance program that you specify or that is peculiar to the industry, such as:
Automotive electrical components, train control, telecommunications devices (mainline), traffic light control, electric power, combustion control, fire prevention or security systems, disaster prevention equipment, etc.
 - We may separately give you our support with a quality assurance program that you specify, when you think of a use such as :
Aviation or space equipment, submarine repeaters, nuclear power control systems, medical equipment for life support, etc.
 - Recommended applications include:
Computers, office appliances, telecommunications devices (terminals, mobile units), measuring equipment, audiovisual equipment, home electric appliances, factory automation equipment, etc.

Japan Aviation Electronics Industry, Limited

Advanced-Product Development Planning Dept. Connector Division
 Aobadai Building, 3-1-19, Aobadai, Meguro-ku, Tokyo 153-8539
 Phone: +81-3-3780-2882 FAX: +81-3-3780-2946

* The specifications in this brochure are subject to change without notice. Please contact JAE for information.

X-ON Electronics

Largest Supplier of Electrical and Electronic Components

Click to view similar products for [Automotive Connectors](#) category:

Click to view products by [JAE](#) manufacturer:

Other Similar products are found below :

[003-018-000](#) [60993906-B](#) [M902-2131](#) [M902-2161](#) [M902-2344](#) [72.330.1035.1](#) [73.353.4028.0](#) [F166900](#) [F358300-B](#) [F407400](#) [776880-1](#)
[827153-1](#) [8N1515-32-24P](#) [9-1326729-8](#) [925474-1](#) [928905-1](#) [964562-4](#) [968782-1](#) [98891-1012](#) [12004475-L](#) [12020308](#) [12041318-B](#)
[12052466](#) [12064869](#) [12015909](#) [1-21030-1](#) [12041254](#) [12041318](#) [12047946-B](#) [12110546-B](#) [12131792](#) [12084688](#) [12092346](#) [HD34-18-14PT](#)
[HD46-24-23SN-059](#) [HDB36-24-16PN-059](#) [HDP26-24-9SE-L015](#) [12185280](#) [12185550](#) [12336-12](#) [12191172-B](#) [12S](#) [13545280](#) [13577943](#)
[13681974](#) [13737722-B](#) [13830674](#) [13832576](#) [13849772](#) [13542772](#)