

# JBC

[www.jbctools.com](http://www.jbctools.com)

## INSTRUCTION MANUAL



## B·iRON 210 Precision B·iRON Station

This manual corresponds to the following references:

Console included\*:

- BI210UA** 120 V - N. America, Taiwan
- BI210IA** 230 V - India
- BI210A** 230 V - Europe
- BI210KA** 230 V - United Kingdom
- BI210HA** 230 V - China
- BI210JA** 100 V - Japan

Console not included\*:

- BI210UQA** 120 V - N. America, Taiwan
- BI210IQA** 230 V - India
- BI210QA** 230 V - Europe
- BI210KQA** 230 V - United Kingdom
- BI210HQA** 230 V - China
- BI210JQA** 100 V - Japan

## Packing List

The following items are included:



**Stand for  
B 210 Precision Tool ...** 1 unit  
Ref. B210-SA



**B 210 Precision Tool...**1 unit  
Ref. B210-A



**B-iRON Console** ..... 1 unit\*  
*\*included according purchased reference*



**Cable USB** ..... 1 unit  
Ref. 0028092



**Brass Wool** ..... 1 unit  
Ref. CL0300  
*already assembled in the stand*



**Manual** ..... 1 unit  
Ref. 0027779



**Power Cord** ..... 1 unit\*

|              |                           |         |                       |
|--------------|---------------------------|---------|-----------------------|
| Ref. 0027380 | 120V - N. America, Taiwan | 0027378 | 230V - United Kingdom |
| 0027381      | 230V - India              | 0027379 | 230V - China          |
| 0027382      | 230V - Europe             | 0028103 | 100V - Japan          |

\* according to purchased station reference.

## Features and Connections



### B-iRON Console

**Note:** for references without console blue tooth device like PC or mobile can be connected.

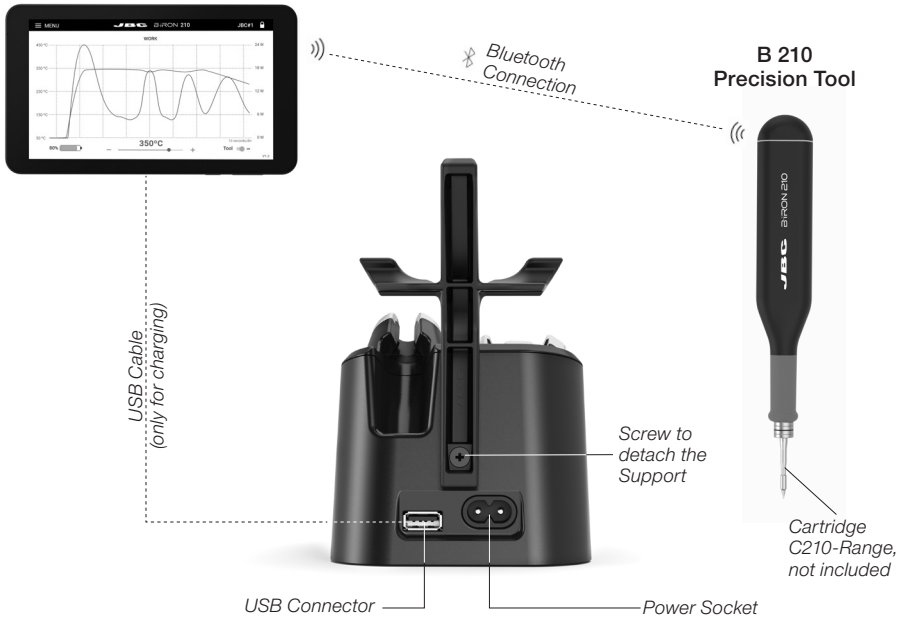

# Quick Start

## 1. Connection

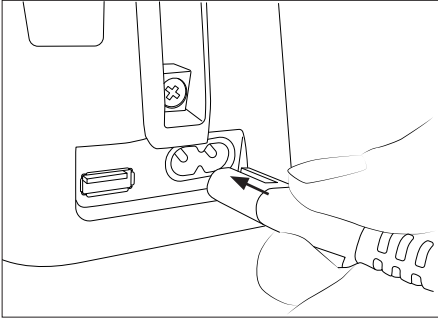

Connect the stand to the mains (100 - 240 V).

## 2. Cartridge Insertion and Charging

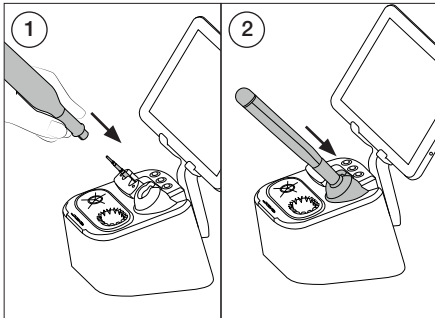

Insert a cartridge into the tool (1) and place it into the charger on the stand (2).

**Note:** Charge the tool completely (30 min) before using for the first time.

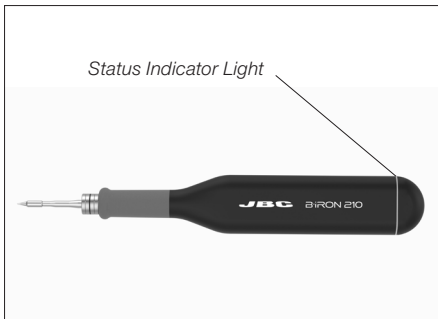

The status indicator light indicates as follows the tool status:

|                                |                            |
|--------------------------------|----------------------------|
| green                          | working/soldering          |
| green blinking                 | charging                   |
| alternating red/green blinking | low battery, less than 20% |
| red blinking:                  | no cartridge               |
| no color:                      | power OFF                  |



### 3. Switching on Console/Device

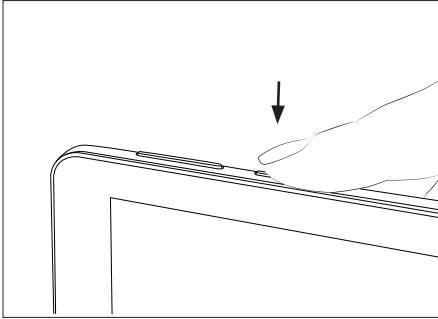

Turn on the console/device and open the B:iRON Application:



### 4. Selecting Tool

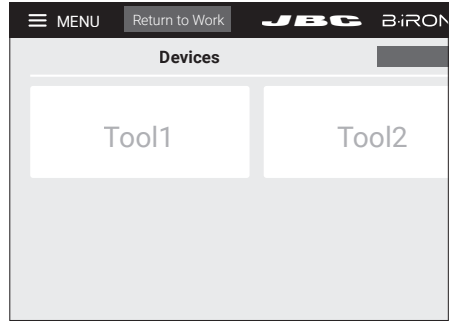

Select the tool from the detection list.

## Console Work Screen

The work screen shows the graph of the current tip temperature and the power supplied to the tip by moving the graph permanently to the left.

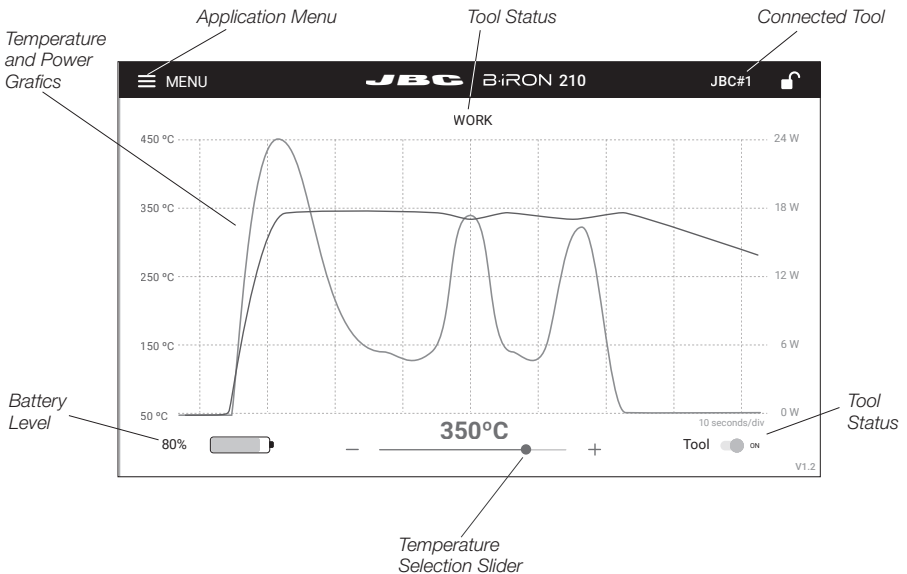

# Operation

## The JBC Most Efficient Soldering System

This revolutionary technology is able to recover tip temperature extremely quickly. This allows the user to work at a lower temperature. As a result, tip life increases by 5.

### Work

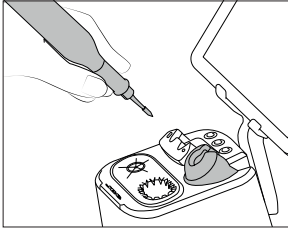

When the tool is lifted from the stand the tip will heat up to the selected temperature.

### Charging and Hibernation

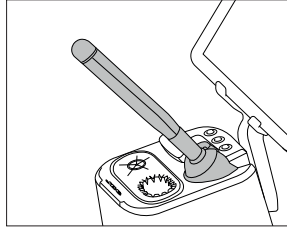

When the tool is in the stand enters into Hibernation Mode and cools down to room temperature.

While the tool remains in the stand, it charges.

**Note:** When the tool is lifted from stand the Soldering System acts as follows:

### Hibernation

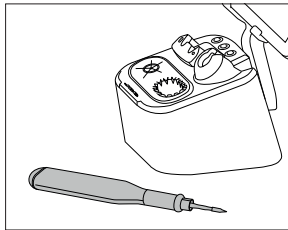

When the tool is outside of the stand and remains inactive (no movement), the tool enters into Hibernation mode and cools down to room temperature.

### Turned Off

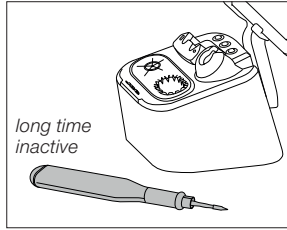

If the tool has been inactive for a longer period of time, it is turned off.

### Turned On

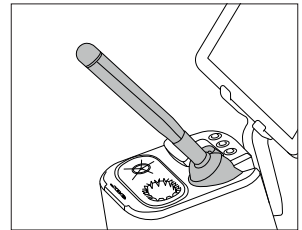

To turn the tool on, put it back into the stand.

**Note:** If desired, the tool can be switched off/on. Tab the Tool Power button at the tablet screen (bottom right) to switch it off/on.

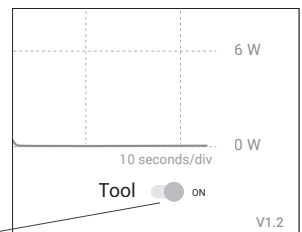

Tool Power Button

## Grafics

The work screen shows the automatic recording of the temperature and power grafics.

The automatic recording can be pause by tapping the screen at the grafic area. The automatic recording stops also when the tool stops working.

While the automatic recording is stopped, you can get the temperature/power value in a concret point by tapping the graph on the tablet screen.

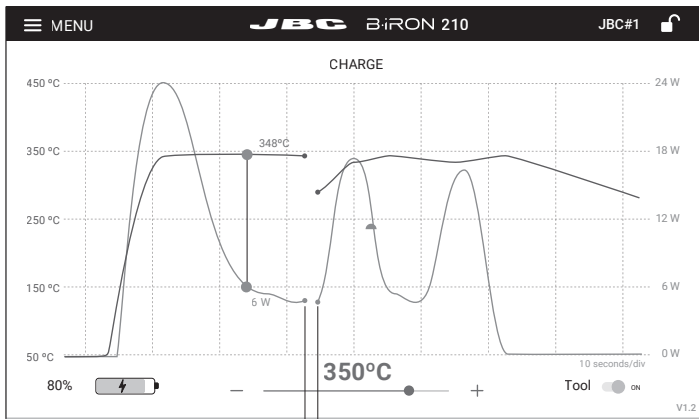

*When the tool ist not in use  
the grafics stops recording*

The grafic can be moved to the left and right by swiping the touch screen sideways with one finger.

The recording starts automatically as soon as the tool is removed from the stand and the graphic automatically jumps to the end of the last recording and continues with the recording.

**Note:** When the tool is placed in the stand and is not in use, the temperature/power recording stops. A gap can then be seen in the curve grafics.

# Tip Cleaner

Select the option to suit your needs and improve the thermal transfer of the tip.

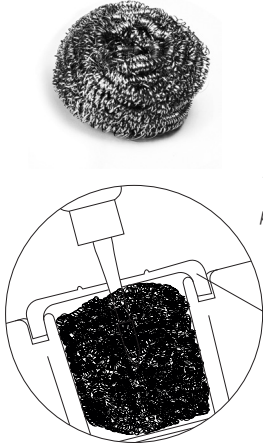

**Brass Wool**  
Ref. CL0300  
*Very effective cleaning method. Leaves a small layer of solder on the tip preventing oxidation between cleaning and reflowing.*

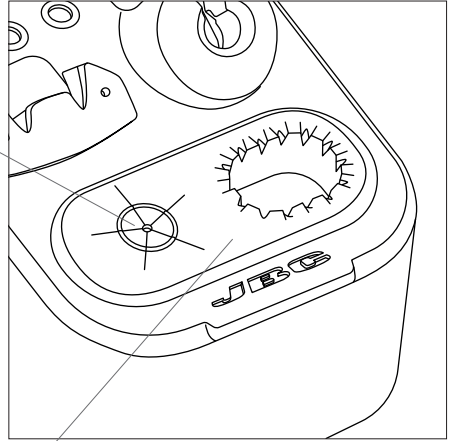

**Antisplash Membrane with Wiper**  
Ref. CL0301

*The antisplash membrane prevents splashing and keeps the work area clean.*

*Includes a temperature resistant wiper for removing excess solder by gently tapping or wiping the cartridge tip.*

*If the tip is very dirty, JBC recommends first cleaning it with the wiper to remove excess solder and then with the brass wool.*

## Wiper

### Tapping

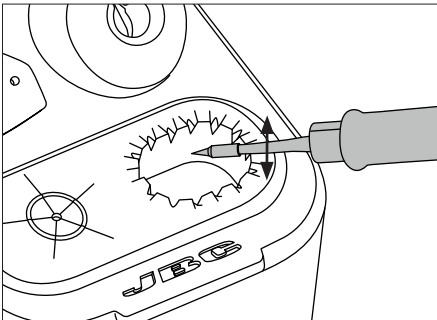

Tap gently to remove excess solder.

### Wiping

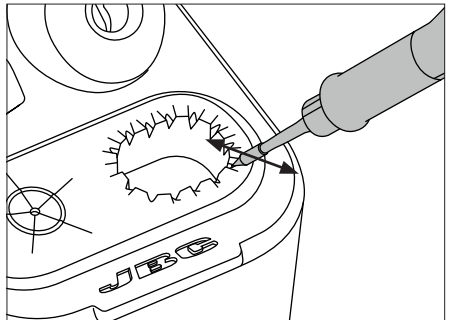

Use the slots to remove remaining particles.

## Replacing Brass Wool

### 1. Lifting

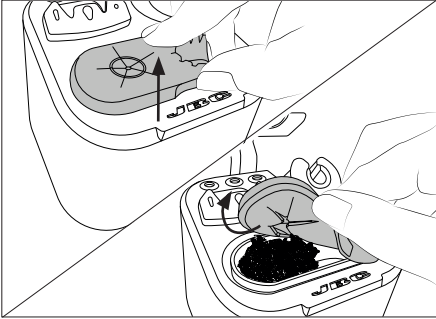

Lift and remove the antisplash membrane.

### 2. Replacing

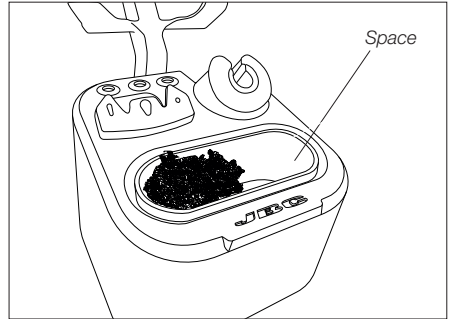

Replace the brass wool with a new one. Make sure that the brass wool is on the far left and that there is space for the wiper on the right.

### 3. Assembling

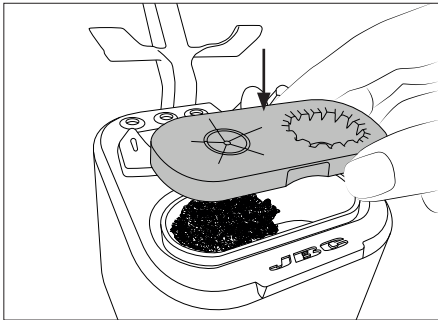

Assemble the antisplash membrane in vertical direction onto the stand.

### 4. Pressing on

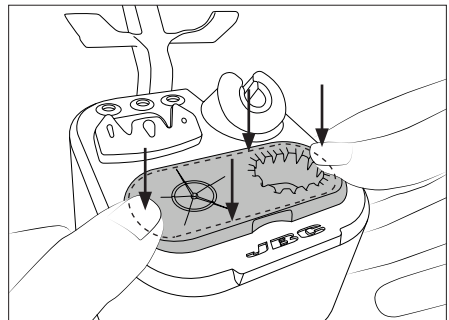

Press the antisplash membrane down. Make sure that the membrane is correctly inserted all around.

**Note:** The brass wool and the wiper position can be reversed by rotating the antisplash membrane 180 degrees

# Quick Tip Changer

Save time and change cartridges safely without switching the station off.

## 1. Removing

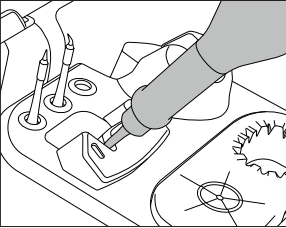

Place the handpiece in the extractor and pull to remove the cartridge.

## 2. Inserting

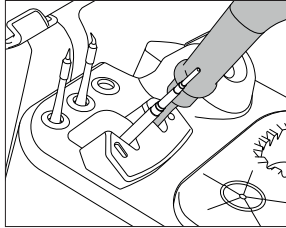

Place the handpiece on top of the new cartridge and press down slightly.

## 3. Fixing

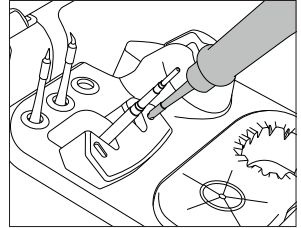

Use the holes for fixing the cartridge.

**\*Important:** Insert the cartridge up to the stop. The charging indicator light changes from red to green when the cartridge is properly inserted.



# Compatible Cartridges

B 210 Precision Tool works with C210 Cartridges.  
Find the model that best suits your soldering needs in [www.jbctools.com](http://www.jbctools.com)



Conical



Chisel



Conical Bent



Bevel

## Changing the Grips

For Precision Tool Ref. B210-A and for Nano Tool Ref. B115-A foam grips Ref. 0028829 are available.

Remove the prior grip and replace the grips easily using the slip-on tabs. To change the grips do as follows:

### 1. Inserting Tabs

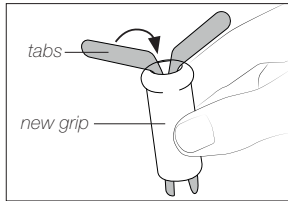

Put the slide-on tabs into the new grip.

### 2. Inserting Handle

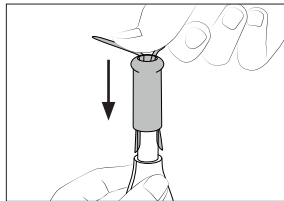

Push the grip with the tabs onto the handle.

### 3. Removing Tabs

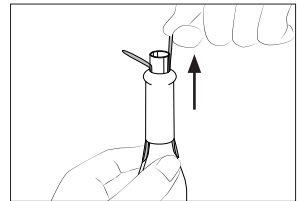

Hold the grip and pull the tab. Use pliers if necessary.

## Menu Settings

The B-iRON Console offers an intuitive user interface which provides quick access to station parameters.

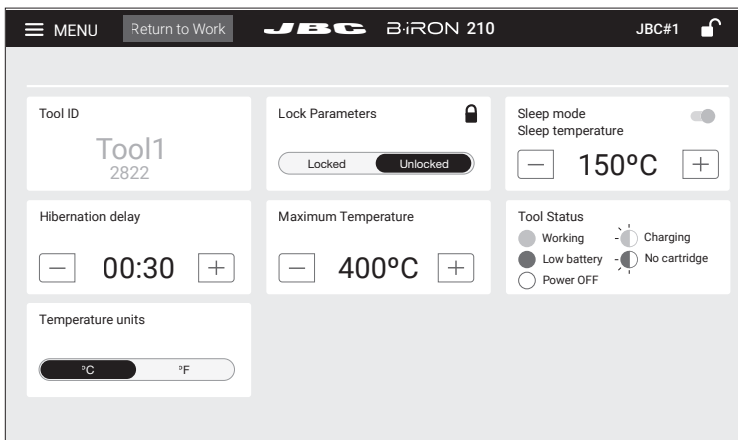

# Parameters

| Parameter                      | Description   |
|--------------------------------|---|
| Tool ID                        | Allows to change the tool identifier.   |
| PIN                            | Allows to change the PIN  |
| Hibernation Delay              | Set hibernation delay from 5 to 15 sec. Countdown starts when no movement is detected.  |
| Sleep Mode / Sleep Temperature | Set sleep mode ON/OFF. The tip temperature will drop to the selected sleep temperature.   |
| Maximum Temperature            | Allows selection of the maximum temperature that can be set for the work mode   |
| Tool Status                    | The tool status light indicates as follows the tool status: <ul style="list-style-type: none"><li>- Green: working / soldering</li><li>- Green blinking: charging</li><li>- Alternating red/green blinking: low battery, less than 20%</li><li>- Red blinking: no cartridge</li><li>- No color: power OFF</li></ul> |



## B·iRON Update

- Download the JBC update file from: <https://www.jbctools.com/jbcsoftware.html>
- Connect the console/device via USB connection to the PC.
- On the console/device notification bar at the top, open “USB Connection Settings” and select “MTP”.
- On the PC copy the downloaded file to “IT706/internal share storage/JBC”.
- Once copying is finished, disconnect the console/device from the PC.
- On the console/device open the Application (1) and then select “update” (2) on the Application Menu.

1



2

Application Menu

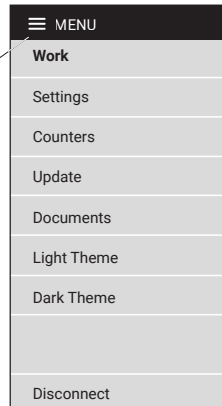

- Use the update button of the version to be downloaded.

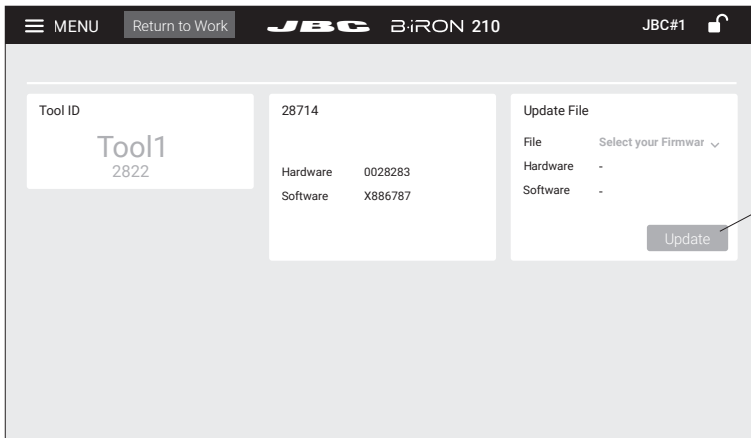

# Maintenance

Before carrying out maintenance, always extract the cartridge and disconnect it from the mains. Allow the equipment to cool down.

- Use a damp cloth to clean the casing and the tool. Alcohol can only be used to clean the metal parts.
- Periodically check that the metal parts of the tool and stand are clean so that the charging works properly.
- Maintain tip surface clean and tinned prior to storage in order to avoid tip oxidation. Rusty and dirty surfaces reduce heat transfer to the solder joint.
- Do not use liquid such as alcohol, thinner or benzene to clean the console.
- Repairs should only be performed by a JBC authorized technical service.

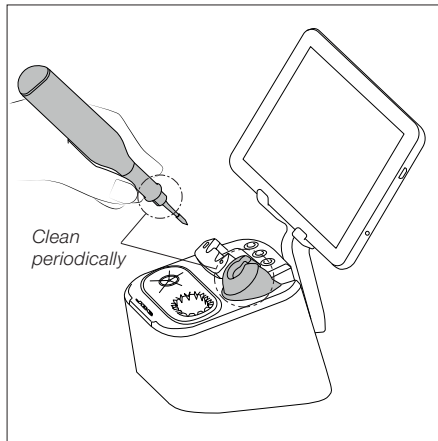

## Safety



**It is imperative to follow safety guidelines to prevent electric shock, injury, fire or explosion.**

- Do not use the units for any purpose other than soldering or rework. Incorrect use may cause fire.
- The power cord must be plugged into approved bases. When unplugging it, hold the plug, not the wire.
- Do not work on electrically live parts.
- The tool should be placed in the stand when not in use in order to charge the batteries.
- The soldering tip or nozzle, the metal part of the tool and the stand may still be hot even when the station is turned off.
- Do not leave the appliance unattended when it is on.
- Avoid flux coming into contact with skin or eyes to prevent irritation.
- Be careful with the fumes produced when soldering.
- Keep your workplace clean and tidy. Wear appropriate protection glasses and gloves when working to avoid personal harm.
- Utmost care must be taken with liquid tin waste which can cause burns.
- This appliance can be used by children over the age of eight and also persons with reduced physical, sensory or mental capabilities or lack of experience provided that they have been given adequate supervision or instruction concerning use of the appliance and understand the hazards involved. Children must not play with the appliance.
- Maintenance must not be carried out by children unless supervised.
- Do not expose the console to high temperatures, humidity or dust. Avoid direct sunlight.
- Do not drop the console as it may cause damage or malfunction.
- Do not disconnect your device when it is in file transfer mode.
- Do not use the console in places where electronic devices are restricted.







## Specifications

### **B-iRON 210**

#### **Precision B-iRON Station**

Ref.: **BI210UA** 120 V - N. America

Ref.: **BI210IA** 230 V - India

Ref.: **BI210A** 230 V - Europe

Ref.: **BI210KA** 230 V - United Kingdom

Ref.: **BI210HA** 230 V - China

Ref.: **BI210JA** 100 V - Japan

#### **Stand:**

- Input: 100 V - 240 V 50/60 Hz
- Power: 15 W
- Tool output: 12 V / 350 mA
- USB output: 5 V / 1000 mA

#### **Tool:**

- Output Peak Power: 24 W
- Battery: Li-Ion 7.4 V / 180 mAh
- Charge Time: 40 minutes
- Temperature Range: 200 - 450 °C / 390 - 840 °F
- Idle Temp. Stability (still air):  $\pm 1.5$  °C /  $\pm 3$  °F
- Temp. Accuracy:  $\pm 3\%$  (Using reference cartridge)
- Connections: Bluetooth Low Energy (BLE)
- Ambient Operating Temp: 10 - 50 °C / 50 - 122 °F
- Tool Weight: 35 g / 0.08 lb
  
- Total Net Weight: 1442 g / 3.18 lb
- Total Package Dimensions / Weight: 265 x 223 x 160 mm / 2000 g
- (L x W x H) 10.43 x 8.78 x 6.30 in / 4.41 lb

Complies with CE standards

ESD safe

Not grounded device. No ESD discharge feature.

# JBC

---

## Warranty

JBC's 2 year warranty covers this equipment against all manufacturing defects, including the replacement of defective parts and labour.

Warranty does not cover product wear or misuse.

In order for the warranty to be valid, equipment must be returned, postage paid, to the dealer where it was purchased.

**Get 1 extra year JBC warranty by registering here:**  
<https://www.jbctools.com/productregistration/>  
**within 30 days of purchase.**

---



This product should not be thrown in the garbage.

In accordance with the European directive 2012/19/EU, electronic equipment at the end of its life must be collected and returned to an authorized recycling facility.

CE EAC

[www.jbctools.com](http://www.jbctools.com)

0027779-230522



## X-ON Electronics

Largest Supplier of Electrical and Electronic Components

*Click to view similar products for [Soldering & Desoldering Stations](#) category:*

*Click to view products by [JBC Tools](#) manufacturer:*

Other Similar products are found below :

[GS1116](#) [WESD51D](#) [BH-010](#) [T0058768747](#) [CA0202](#) [CA0201](#) [WXD2N](#) [Q-7100-9000](#) [T0058757898](#) [WXD2010N](#) [T0058768762](#) [145-2000-ESDN](#) [T0058758721N](#) [0008473](#) [WTL1000-1](#) [MT-688](#) [ZD-415R-H](#) [WELPB102](#) [857DW+](#) [ECC92420EU](#) [850A+](#) [ECC168808EU](#) [9SS-968B-HG](#) [5SS-554-H](#) [5SS-553-H](#) [5SS-552-H](#) [5SS-551-H](#) [5SS-331N1-H](#) [5SI-131-H](#) [5SI-131-3.2D](#) [5SI-131-I](#) [CVC-7CN0004P](#) [CVC-8CH0010S](#) [CV-H5-DSHP](#) [BK-200M-K](#) [0016344](#) [00B.SA.0](#) [0120CDK](#) [0551903](#) [0DIG20A45](#) [0IC1100A](#) [0ICV2000XV](#) [0T56](#) [PX0410/03P/5055](#) [RA150](#) [10G.SA.0](#) [36A.SA](#) [3C.SA](#) [3.TA](#) [AT850D/P](#)