



为您的产品保驾护航

PRODUCT DATASHEET

Surface Mount PTC Devices

ASMD0603 Series Surface Mount PTC Devices

Description

The ASMD0603 series provides miniature surface mount resettable overcurrent protection with holding current from 100mA to 500mA.



This world's smallest PTC is suitable for ultra portable applications where space is at a premium and the device current is low.



Features



- RoHS compliant and lead-free
- Low profile
- Halogen-free
- Fast response to fault current
- Compact design saves board space
- Compatible with high temperature solders

Agency Approvals

Agency	File Number
	pending
	pending

Applications

- Mobile phones and PDAs
- USB peripherals
- Portable MP3 and media player
- IC VCC protection
- Mobile Internet Device (MID)

Regulation	Standard
	2002/95/EC
	EN14582

Performance Specification

Model	V _{max} (V dc)	I _{max} (A)	I _{hold} @25°C (A)	I _{trip} @25°C (A)	P _d Typ. (W)	Maximum Time To Trip		Resistance	
						Current (A)	Time (Sec)	R _{i min} (Ω)	R _{1max} (Ω)
ASMD0603-010	15.0	40	0.10	0.30	0.5	0.5	1.00	0.900	6.000
ASMD0603-020	9.0	40	0.20	0.50	0.5	1.0	0.60	0.550	3.500
ASMD0603-025	9.0	40	0.25	0.55	0.5	8.0	0.08	0.500	3.000
ASMD0603-035	6.0	40	0.35	0.75	0.5	8.0	0.10	0.200	1.400
ASMD0603-050	6.0	40	0.50	1.00	0.5	8.0	0.10	0.100	0.800
ASMD0603-075	6.0	40	0.75	1.40	0.5	8.0	0.10	0.060	0.450
ASMD0603-100	6.0	40	1.00	2.00	0.5	8.0	0.10	0.040	0.300

I_{hold} = Hold Current. Maximum current device will not trip in 25°C still air.

I_{trip} = Trip Current. Minimum current at which the device will always trip in 25°C still air.

V_{max} = Maximum operating voltage device can withstand without damage at rated current (I_{max}).

I_{max} = Maximum fault current device can withstand without damage at rated voltage (V_{max}).

P_d = Power dissipation when device is in the tripped state in 25°C still air environment at rated voltage.

R_{i min/max} = Minimum/Maximum device resistance prior to tripping at 25°C.

R_{1max} = Maximum device resistance is measured one hour post reflow.

CAUTION : Operation beyond the specified ratings may result in damage and possible arcing and flame.

Environmental Specifications

Test	Conditions	Resistance change
Passive aging	+85°C, 1000 hrs.	±5% typical
Humidity aging	+85°C, 85% R.H. , 168 hours	±5% typical
Thermal shock	+85°C to -40°C, 20 times	±33% typical
Resistance to solvent	MIL-STD-202,Method 215	No change
Vibration	MIL-STD-202,Method 201	No change

Ambient operating conditions : - 40 °C to +85 °C

Maximum surface temperature of the device in the tripped state is 125 °C

Thermal Derating Curve

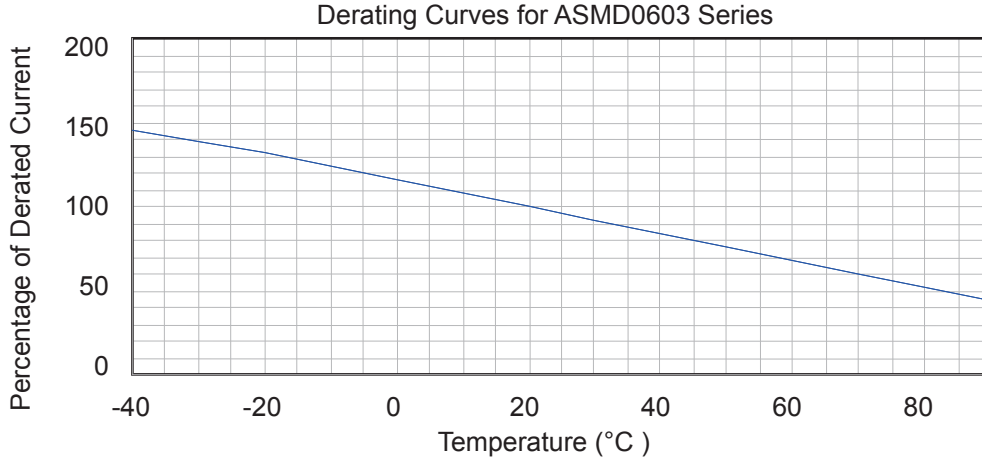

Average Time-Current Curve

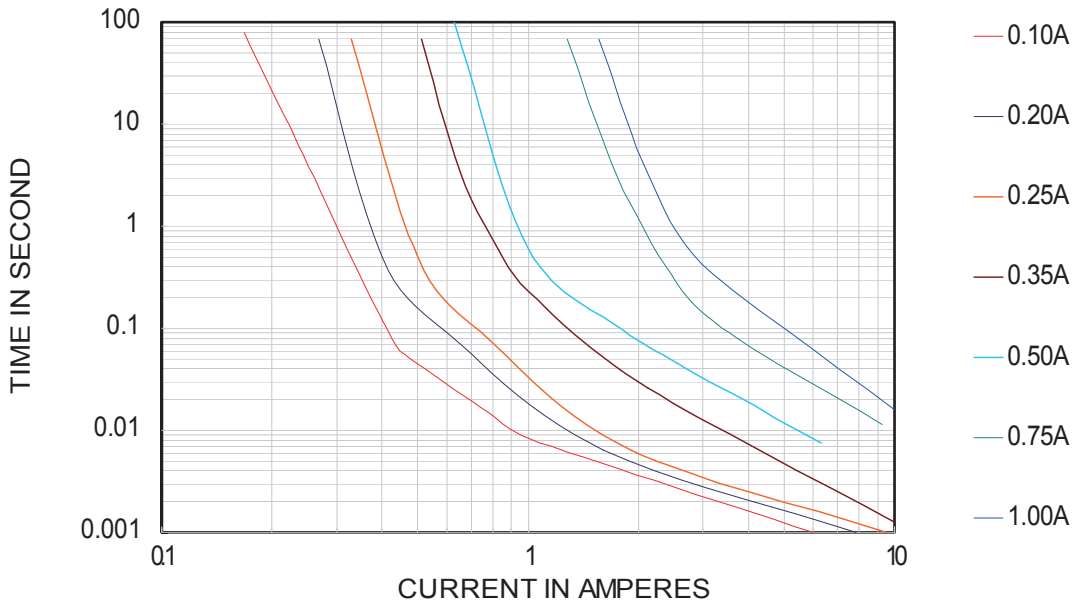

Thermal Derating Chart

Model	Maximum ambient operating temperature (T_{mao}) vs. hold current (I_{hold})								
	- 40°C	- 20°C	0°C	25°C	40°C	50°C	60°C	70°C	85°C
ASMD0603-010	0.13	0.12	0.11	0.10	0.08	0.07	0.06	0.05	0.03
ASMD0603-020	0.27	0.25	0.23	0.20	0.17	0.14	0.12	0.10	0.07
ASMD0603-025	0.32	0.29	0.27	0.25	0.21	0.18	0.16	0.05	0.03
ASMD0603-035	0.47	0.41	0.38	0.35	0.29	0.26	0.24	0.20	0.14
ASMD0603-050	0.67	0.59	0.54	0.50	0.41	0.37	0.34	0.29	0.20
ASMD0603-075	0.98	0.85	0.81	0.75	0.60	0.54	0.44	0.40	0.31
ASMD0603-100	1.30	1.12	1.08	1.00	0.80	0.72	0.58	0.53	0.42

Soldering Parameters

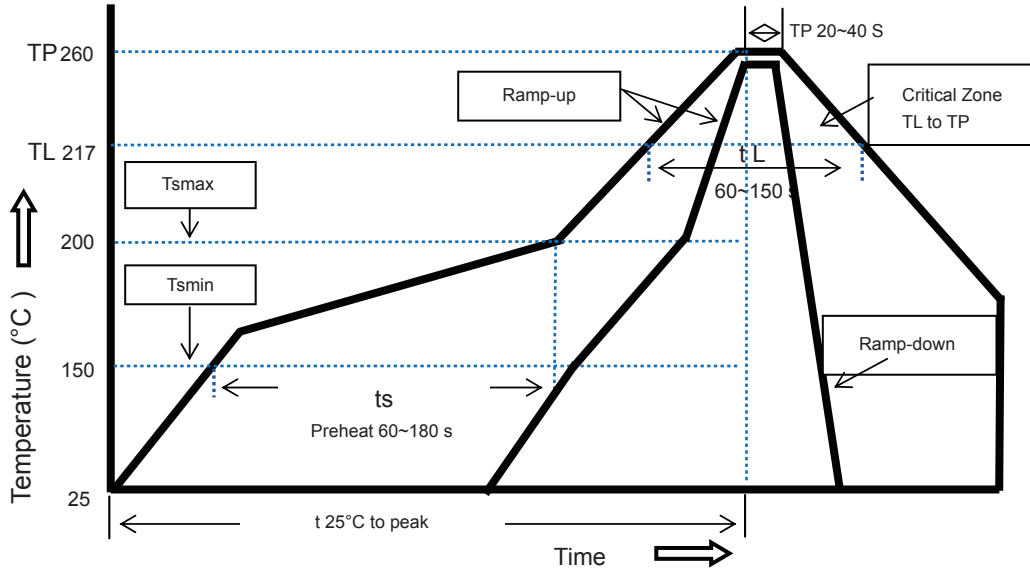

Profile Feature	Pb-Free Assembly
Average Ramp-Up Rate (Ts max to T p)	3 °C/second max.
Preheat	
-Temperature Min(Ts min)	150 °C
-Temperature Max(Ts max)	200 °C
-Time(Ts min to Ts max)	60~180 seconds
Time maintained above:	
-Temperature(TL)	217 °C
-Time(tL)	60~150 seconds
Peak Temperature(Tp)	260 °C
Ramp-Down Rate	6 °C/second max.
Time 25 °C to Peak Temperature	8 minutes max
Storage Condition	0 °C~35 °C, ≤70%RH

Recommended reflow methods: IR, vapor phase oven, hot air oven, N2 environment for lead-free

Recommended maximum paste thickness is 0.25mm

Devices can be cleaned using standard industry methods and solvents.

Note 1: All temperature refer to topside of the package, measured on the package body surface.

Note 2: If reflow temperatures exceed the recommended profile, devices may not meet the performance requirements.

Physical Dimensions(mm.)

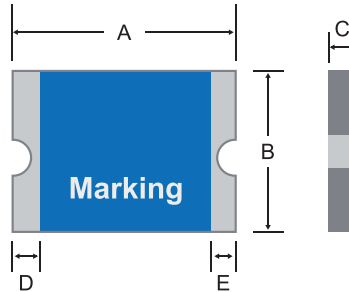

Model	A		B		C		D	E
	Min.	Max.	Min.	Max.	Min.	Max.	Min.	Min.
ASMD0603-010	1.45	1.85	0.65	1.05	0.40	1.00	0.15	0.10
ASMD0603-020	1.45	1.85	0.65	1.05	0.40	1.00	0.15	0.10
ASMD0603-025	1.45	1.85	0.65	1.05	0.40	1.00	0.15	0.10
ASMD0603-035	1.45	1.85	0.65	1.05	0.40	1.00	0.15	0.10
ASMD0603-050	1.45	1.85	0.65	1.05	0.50	1.10	0.15	0.10
ASMD0603-075	1.45	1.85	0.65	1.05	0.50	1.10	0.15	0.10
ASMD0603-100	1.45	1.85	0.65	1.05	0.50	1.10	0.15	0.10

Termination Pad Characteristics

Terminal pad materials: Tin-plated Nickel-Copper

Terminal pad solder ability: Meets EIA specification RS186-9E and ANSI/J-STD-002 Category 3

Packaging Quantity and Marking

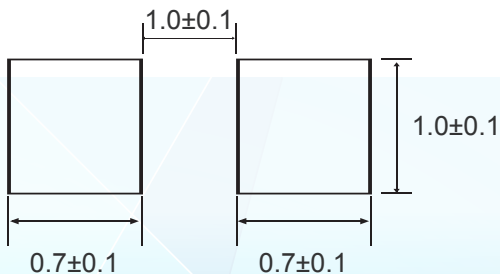

Part Number	Quantity
SMD0603 HF Series	5,000 pcs/reel
Tape & reel packaging per EIA481-1	

Tape And Reel Specifications (mm)

Governing Specifications

W	8.0 ± 0.2
P0	4.0 ± 0.10
P1	4.0 ± 0.10
P2	2.0 ± 0.05
A0	1.05 ± 0.10
B0	1.85 ± 0.10
B1max.	1.55 + 0.05
D0	3.5 ± 0.05
F	1.75 ± 0.10
E1	6.25
E2min.	0.75
T	0.1
T1max.	0.75/0.95 ± 0.1
K0	
Leader min.	390
Trailer min.	160
Reel Dimensions	
A max.	178
N min.	60
W1	
W2	9.0 ± 0.5
	12.0 ± 0.05

Storage And Handling

- Storage conditions: 40°C max, 70% R.H.
- Devices may not meet specified performance if storage conditions are exceeded. Technology Corp.

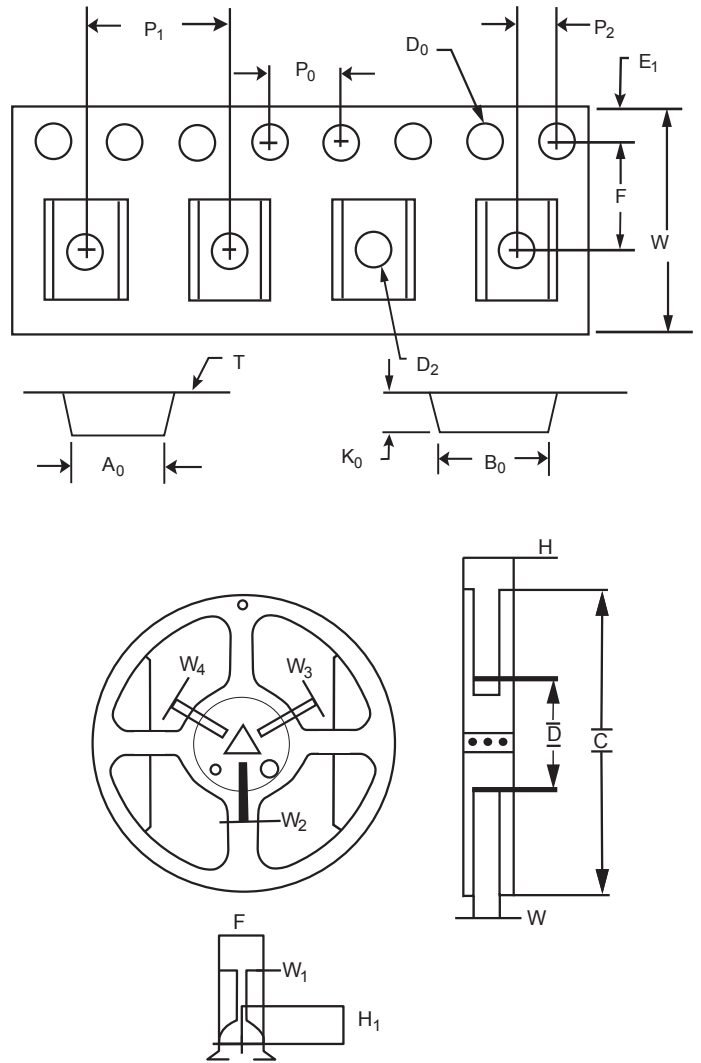

Part Number System

ASMD 0603 - □□□ - □□

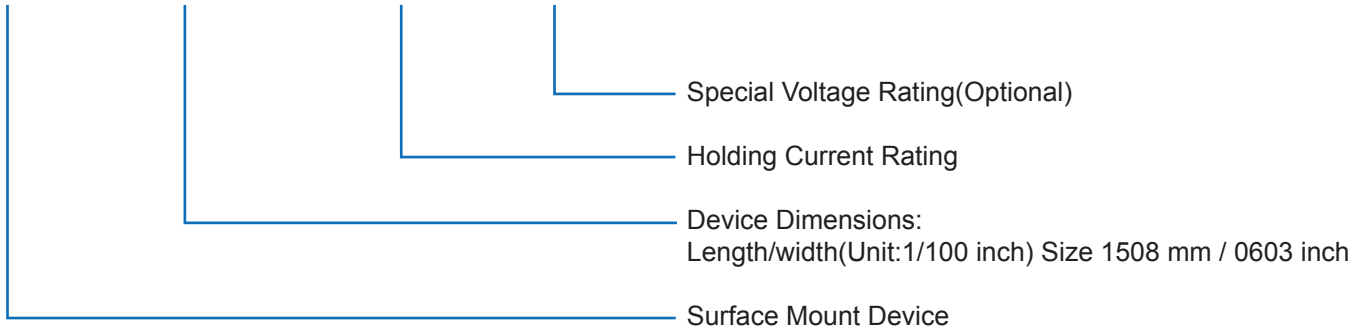

Cross Reference

Model	Cross Reference		
	Tyco / PolySwitch®	Littelfuse / POLY-FUSE®	Polytronics / EVERFUSE®
ASMD0603-010	-	0603L010	SMD0603P010TF
ASMD0603-020	-	0603L020	SMD0603P020TF
ASMD0603-025	-	0603L025	SMD0603P025TF
ASMD0603-035	-	0603L035	SMD0603P035TF
ASMD0603-050	-	0603L050	SMD0603P050TF
ASMD0603-075	-	-	-
ASMD0603-100	-	-	-

“PolySwitch” is a registered trademark of Tyco Electronics.

“POLY-FUSE” is a registered trademark of Littelfuse, Inc.

“EVERFUSE” is a registered trademark of Polytronics Technology Corp.

X-ON Electronics

Largest Supplier of Electrical and Electronic Components

Click to view similar products for [Resettable Fuses - PPTC](#) category:

Click to view products by [JDT](#) manufacturer:

Other Similar products are found below :

[RF0077-000](#) [RF3256-000](#) [RF3281-000](#) [RF3301-000](#) [RF3341-000](#) [RF3344-000](#) [RF3382-000](#) [SMD125-2](#) [RF2171-000](#) [RF2531-000](#) [RF2873-000](#) [RF3060-000](#) [TR600-150Q-B-0.5-0.130](#) [RXE090](#) [5E4795/04-1502](#) [TRF250-080T-B-1.0-0.125](#) [SMD100-2](#) [NIS5452MT1TXG](#) [NIS5431MT1TXG](#) [SMD250-2](#) [0ZCM0001FF2G](#) [0ZCM0003FF2G](#) [0ZCM0004FF2G](#) [BK60-017-DZ-E0.6](#) [F95456-000](#) [LVR100S](#) [RS30-090](#) [RS30-110](#) [RS30-600](#) [RS30-700](#) [RS30-800](#) [RS30-900](#) [RS60RB-005](#) [RS60RB-010](#) [RS60RB-020](#) [RS60RB-025](#) [RS60RB-050](#) [RS60RB-075](#) [RS60RB-160](#) [RS60SB-250](#) [ASMD0603-010-30V](#) [ASMD0603-025-16V](#) [ASMD2920-260-24V](#) [BSMD0603-025-12V](#) [BSMD1206-150-12V](#) [BSMD0805-020-33V](#) [BSMD1206-075-13.2V](#) [BSMD2920-400-6V](#) [BSMD2920-300-6V](#) [BSMD2920-700-6V](#)